

Pancreatic secretion

all genes

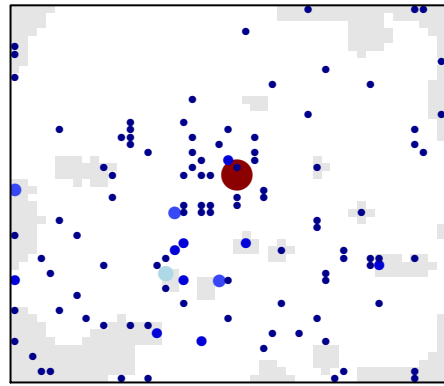

sink node genes

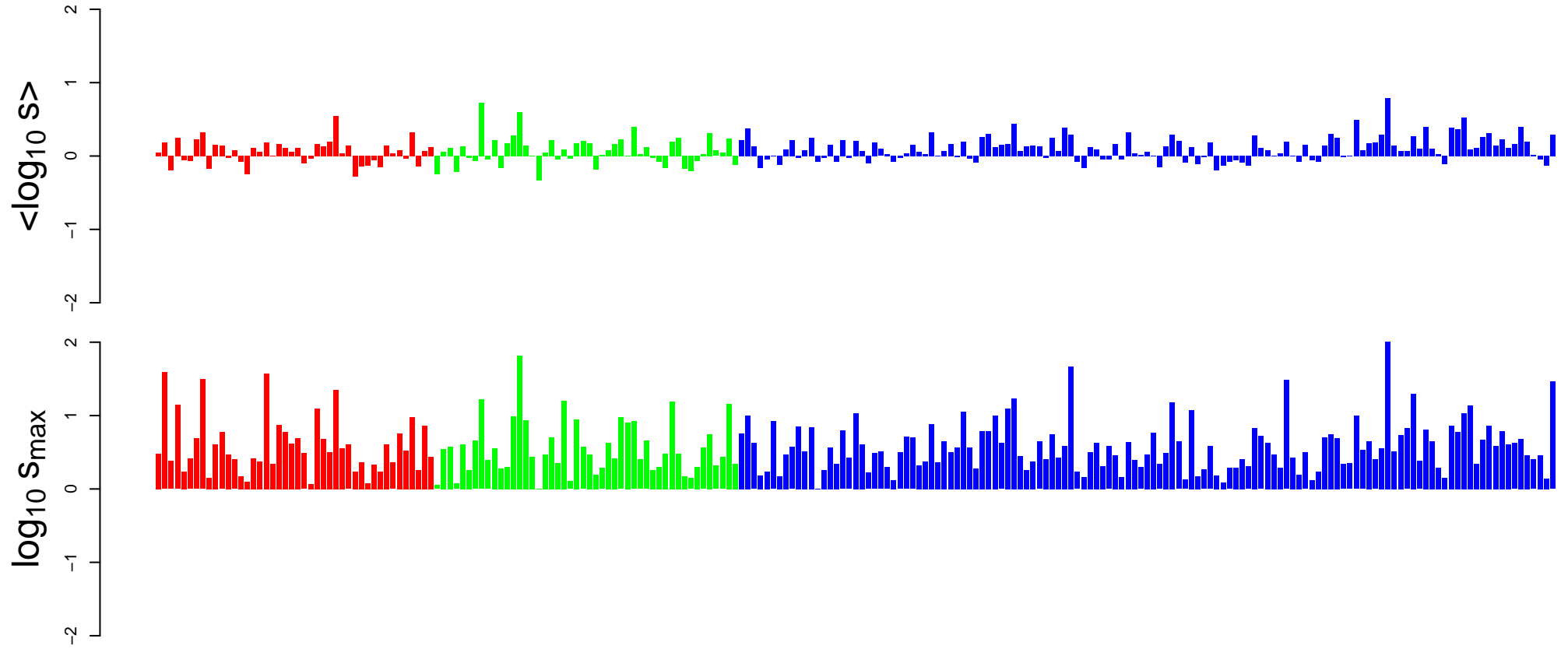
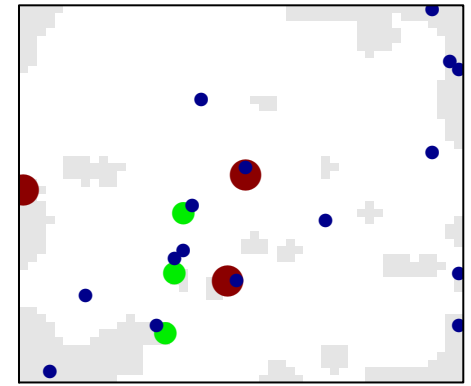

Pancreatic secretion
(genes with data)

C01330
C00001

Tight junction

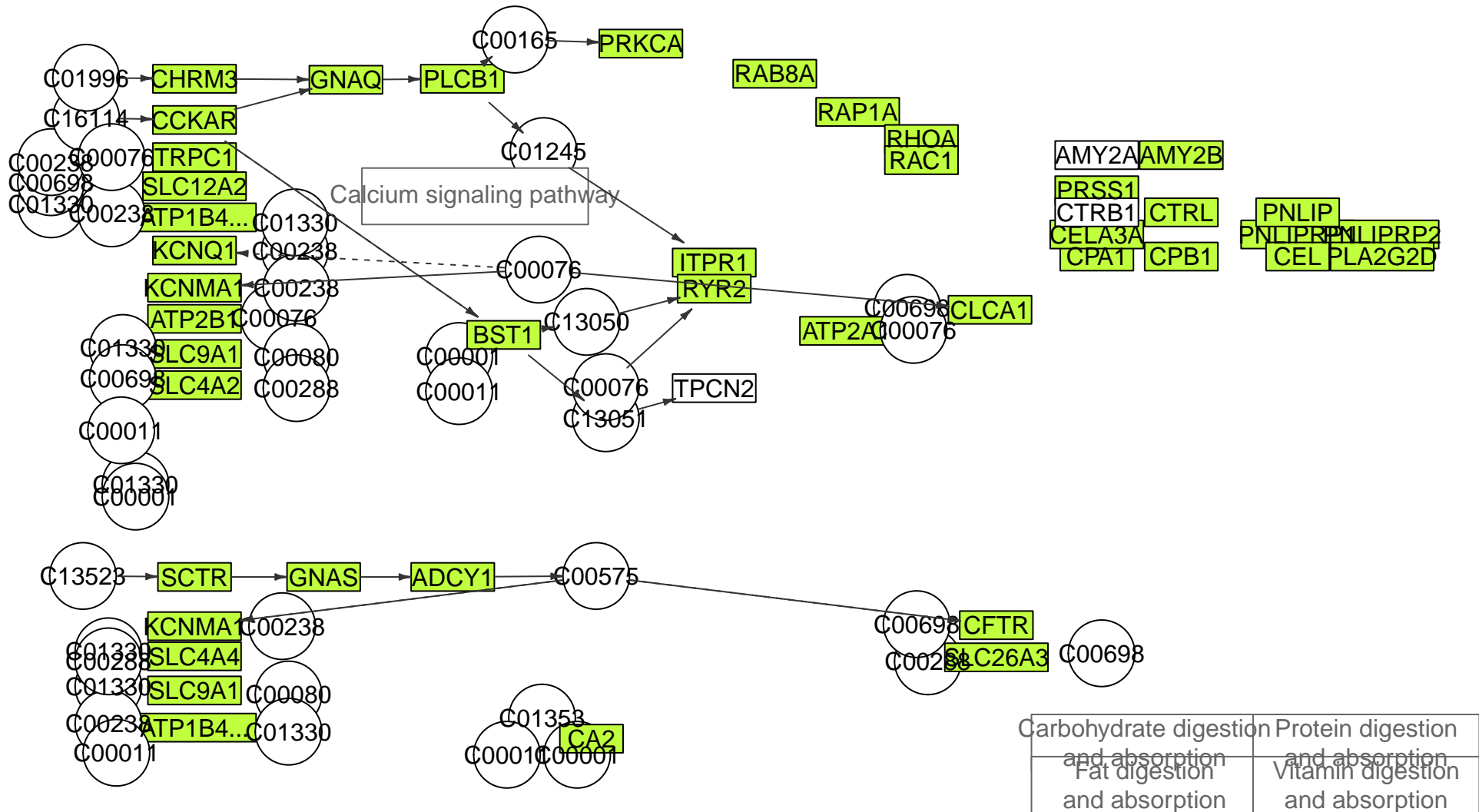

Pancreatic secretion
(sink nodes)



Tight junction

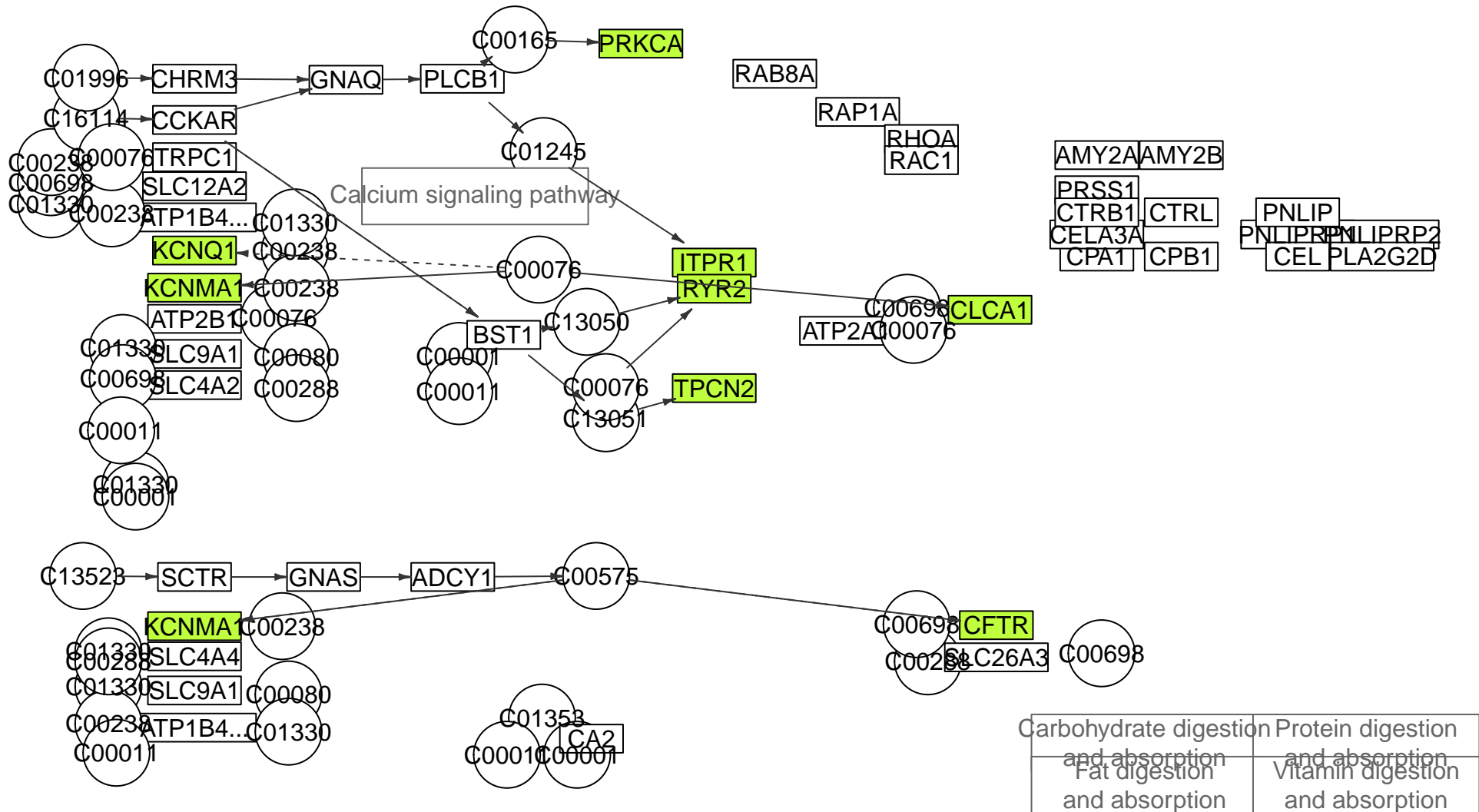

Pancreatic secretion
MPI-001

Tight junction

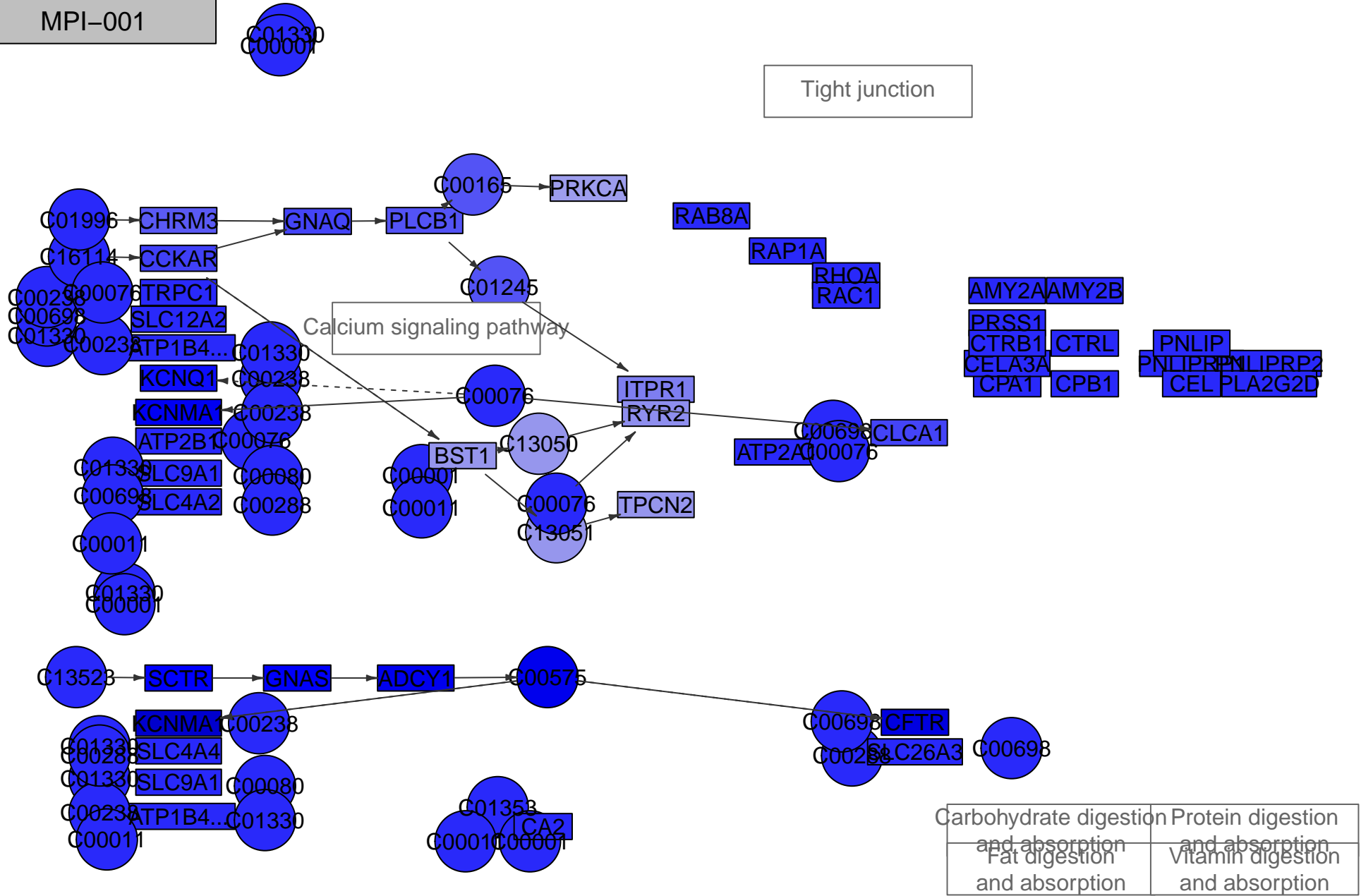

Pancreatic secretion
MPI-003



Tight junction

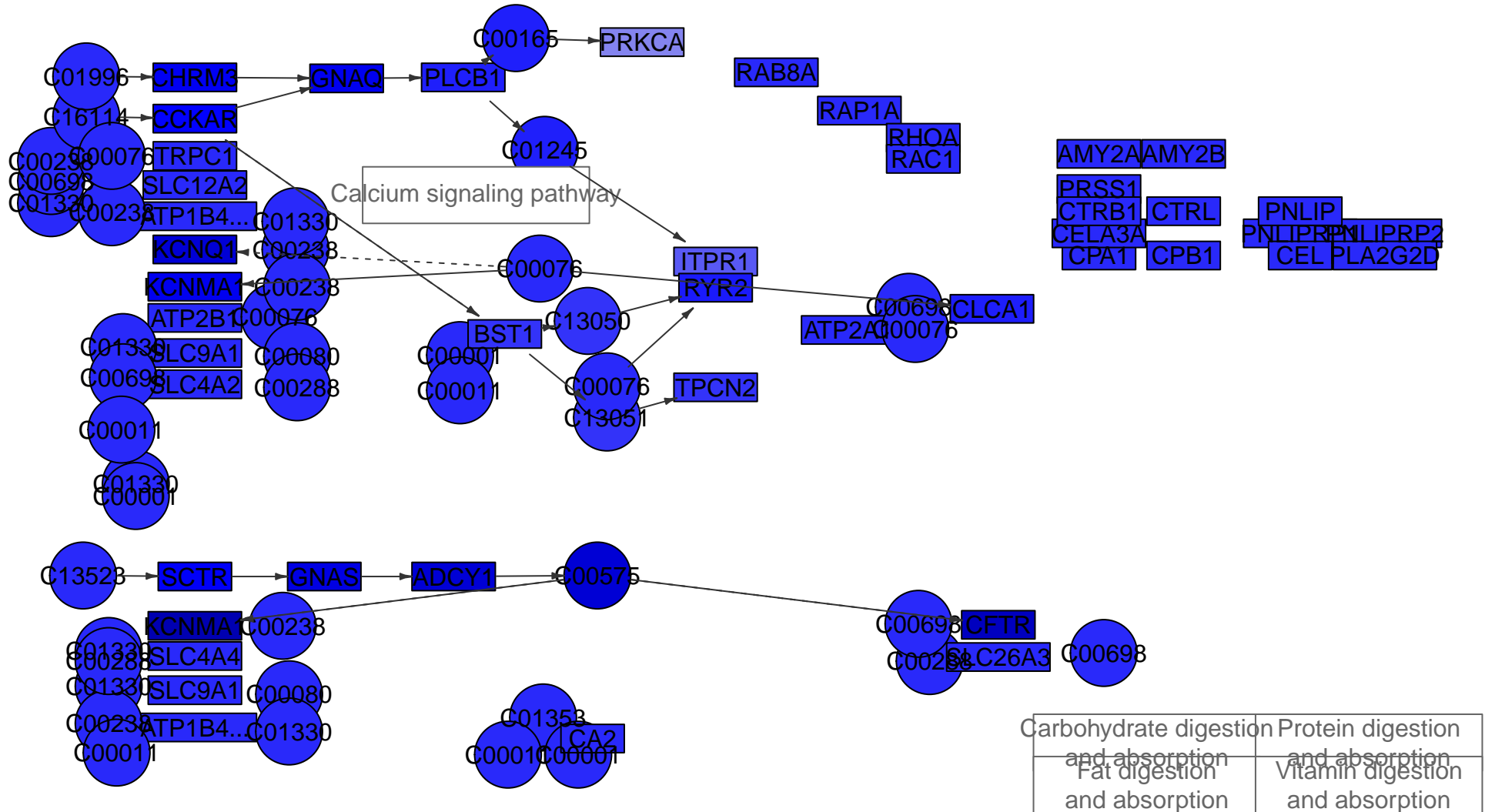

Pancreatic secretion
MPI-005



Tight junction

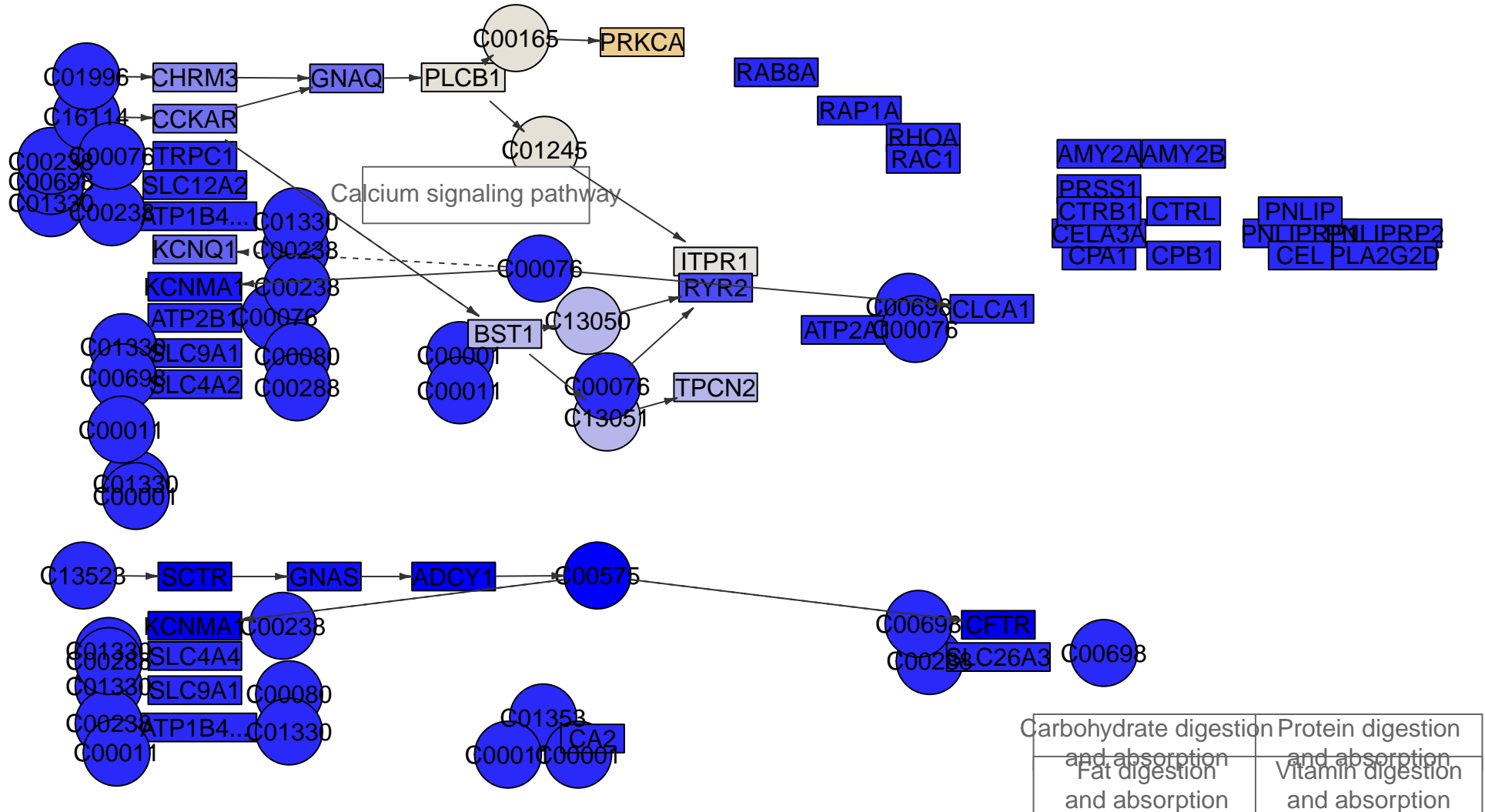

Pancreatic secretion
MPI-006



Tight junction

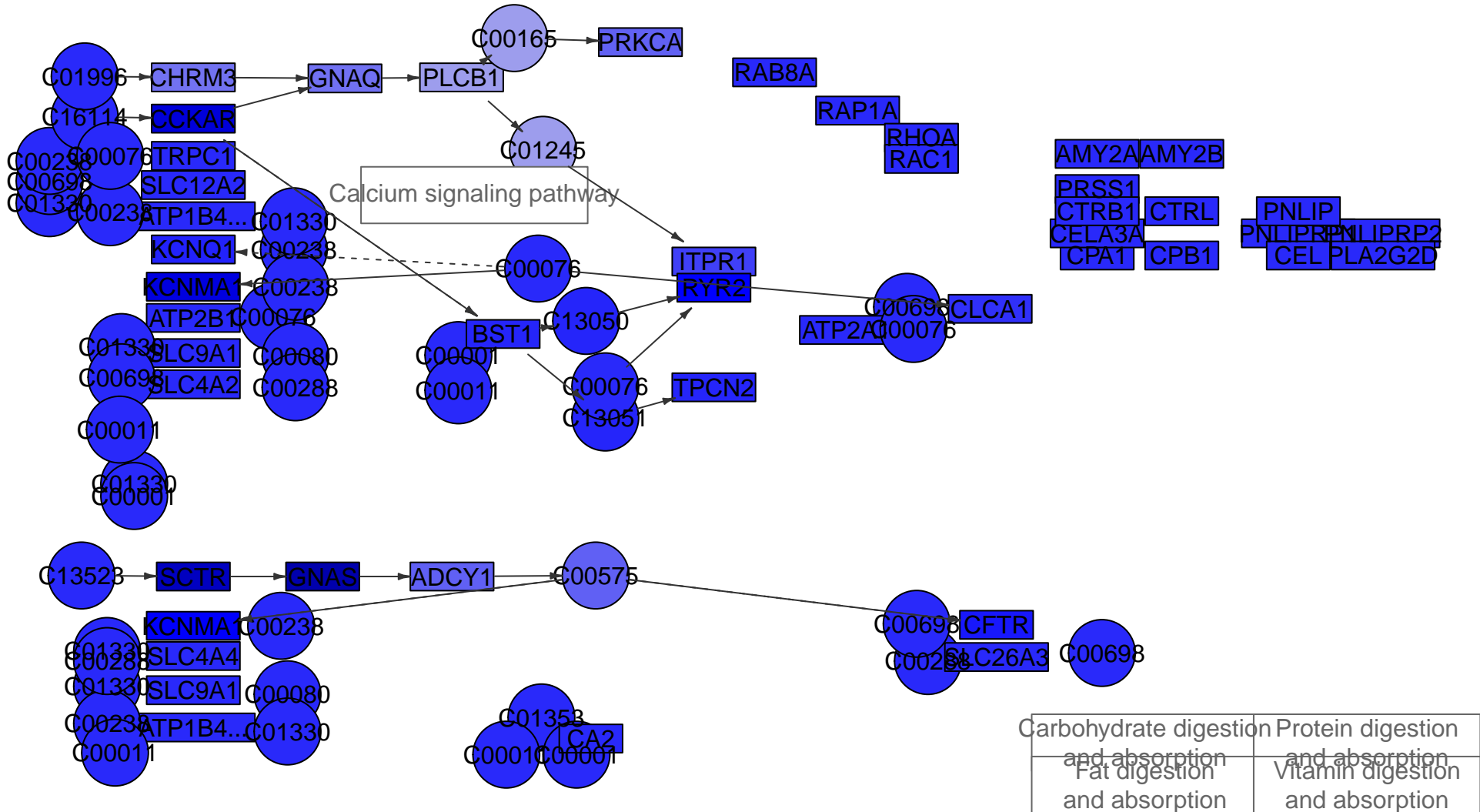

Pancreatic secretion
MPI-016



Tight junction

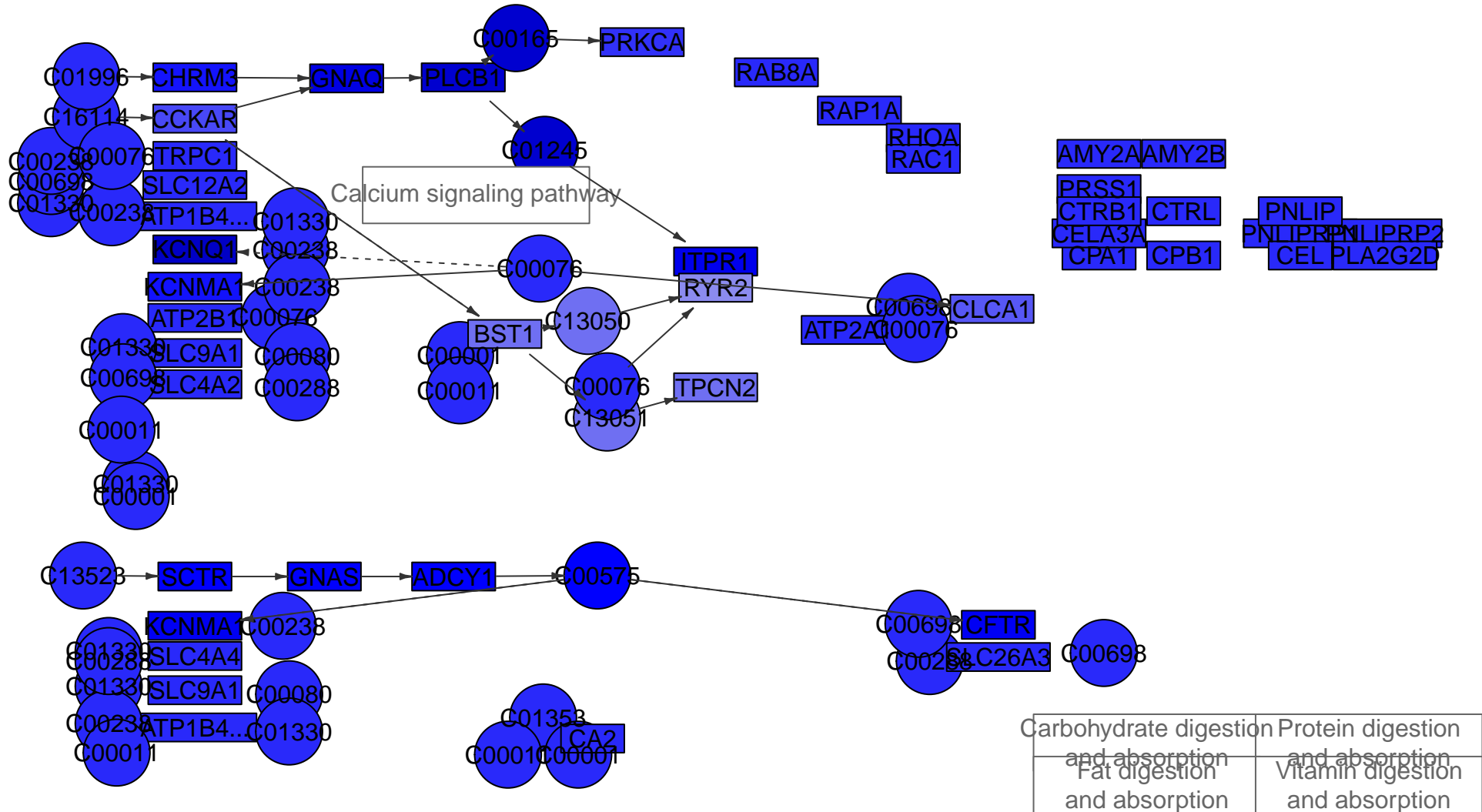

Pancreatic secretion
MPI-017

Tight junction

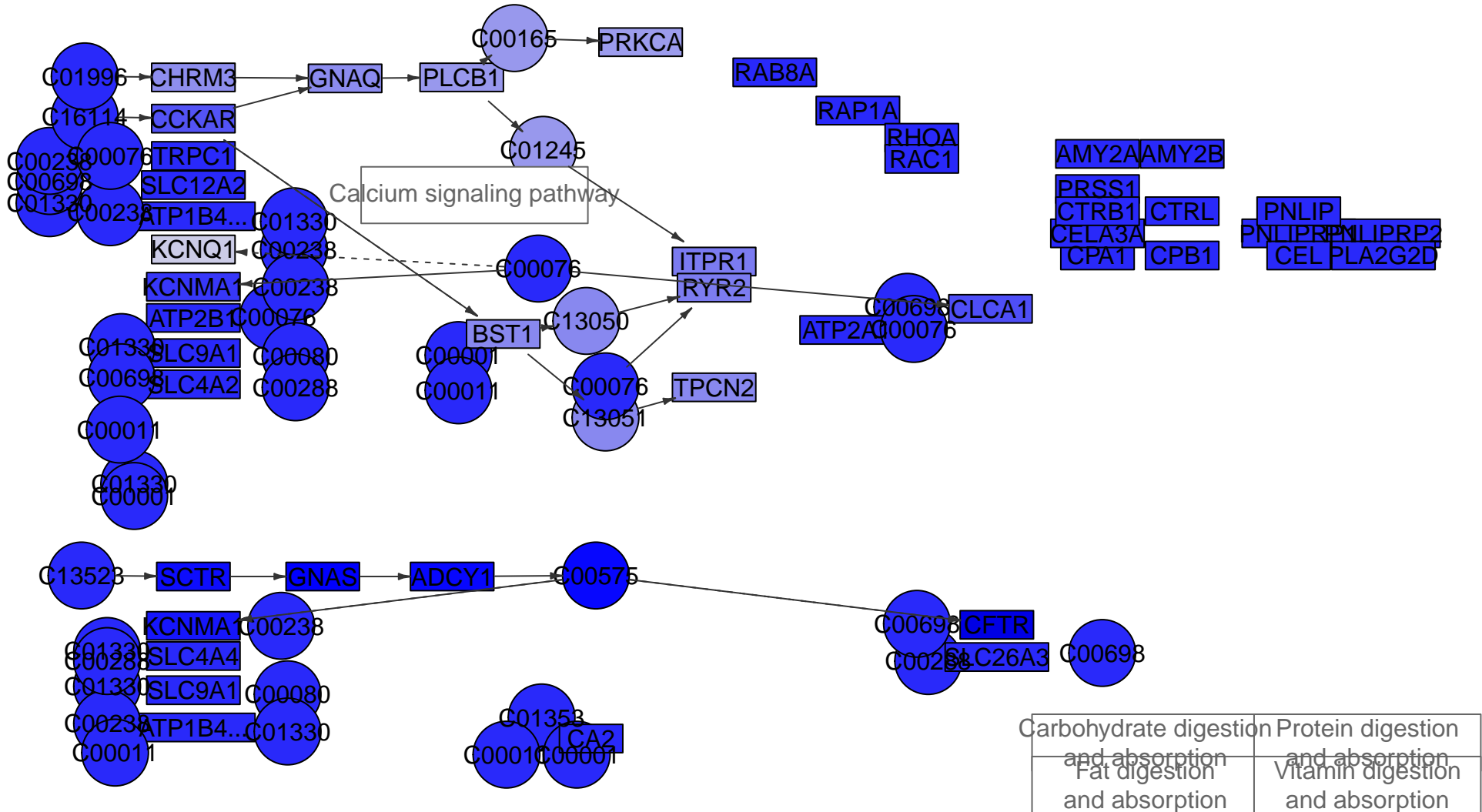

Pancreatic secretion
MPI-018



Tight junction

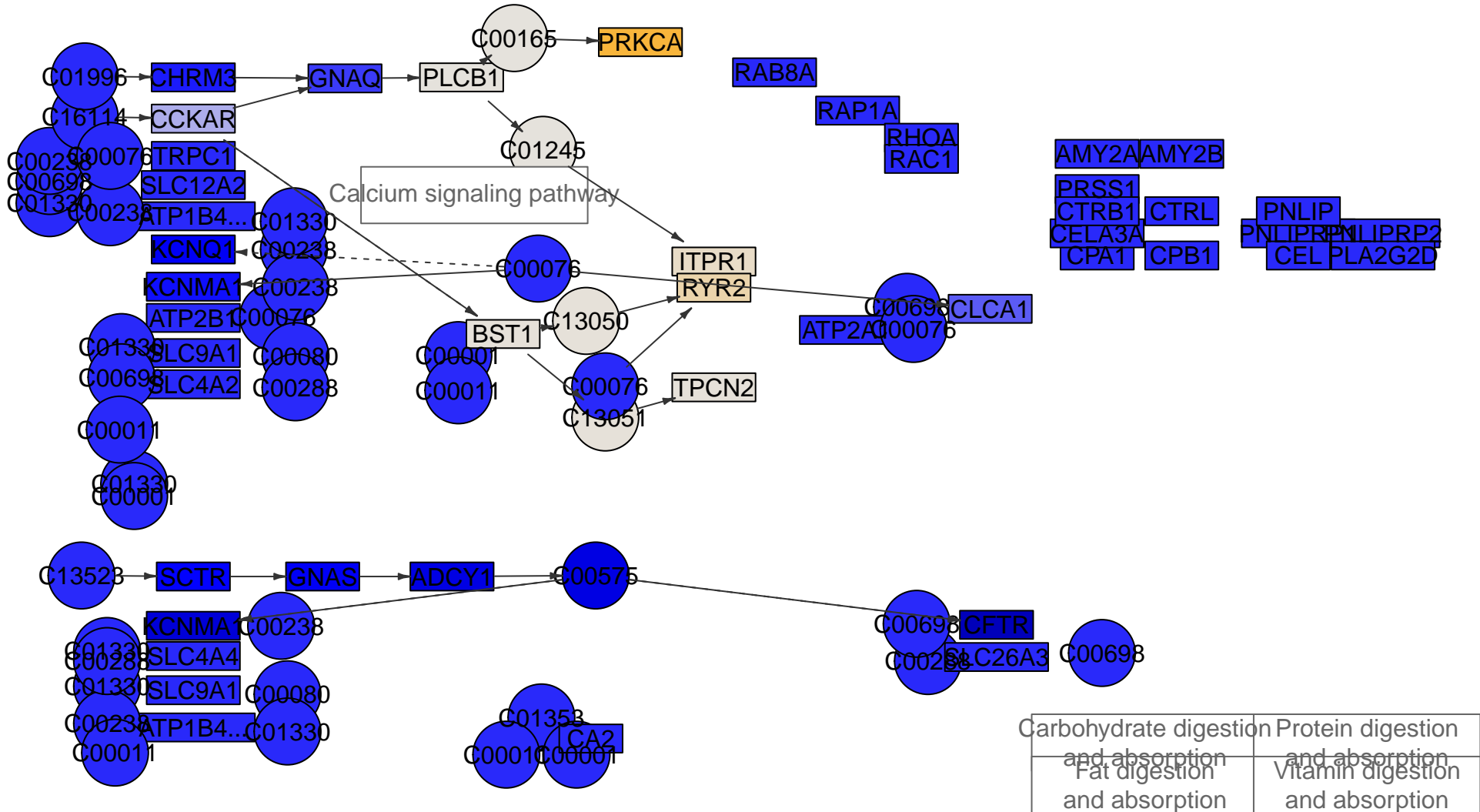

Pancreatic secretion
MPI-027

Tight junction

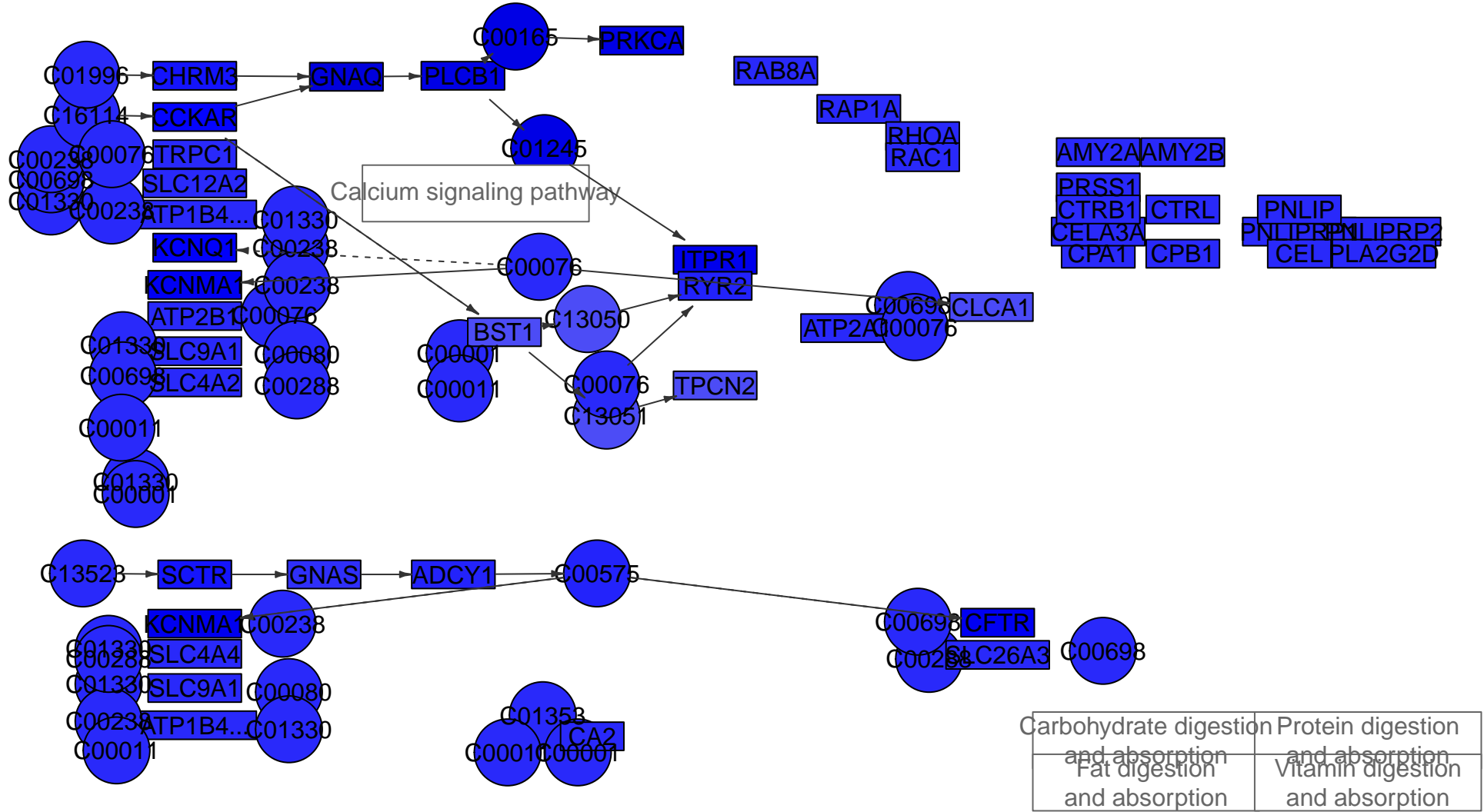

Pancreatic secretion
MPI-028



Tight junction

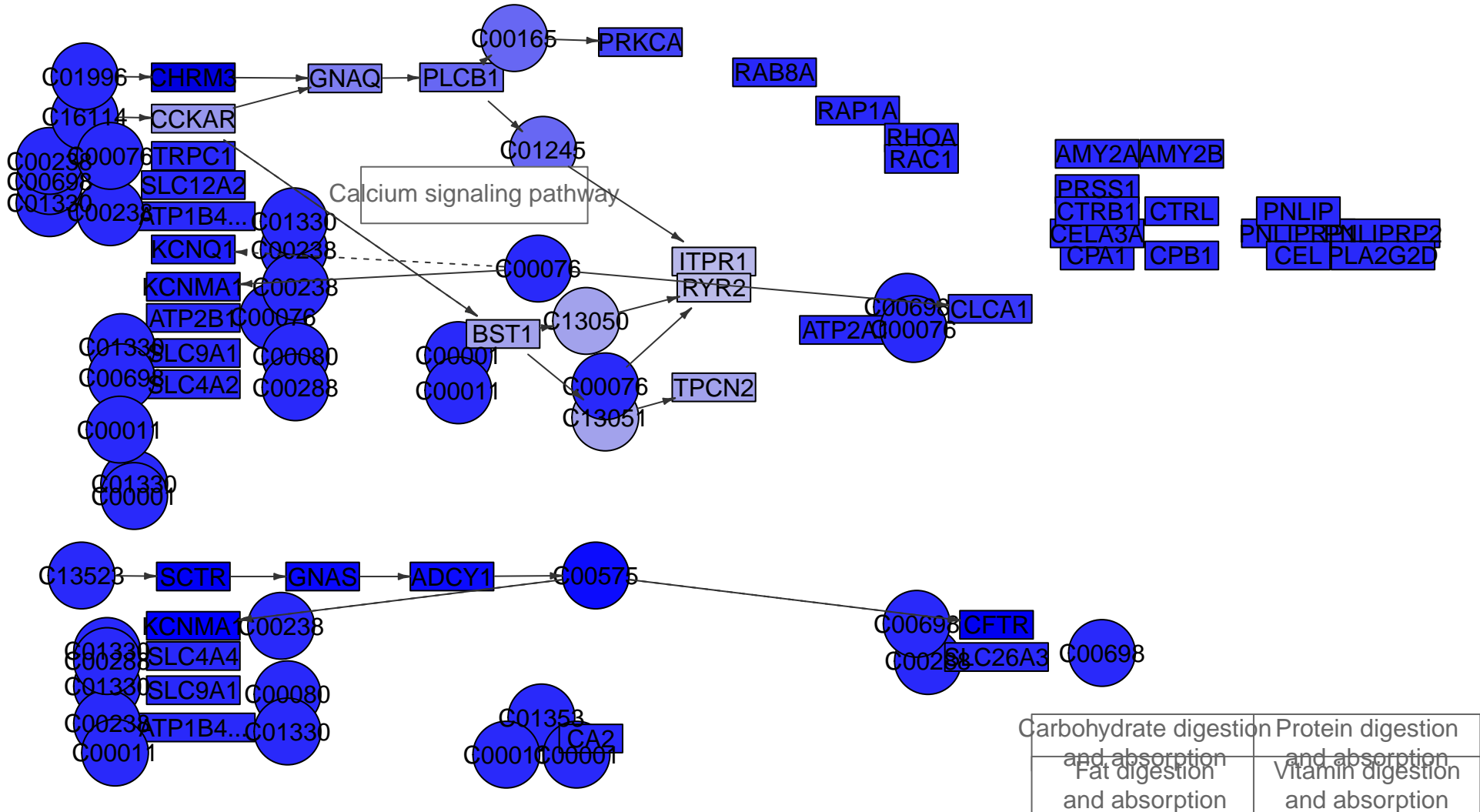

Pancreatic secretion
MPI-032

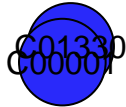

Tight junction

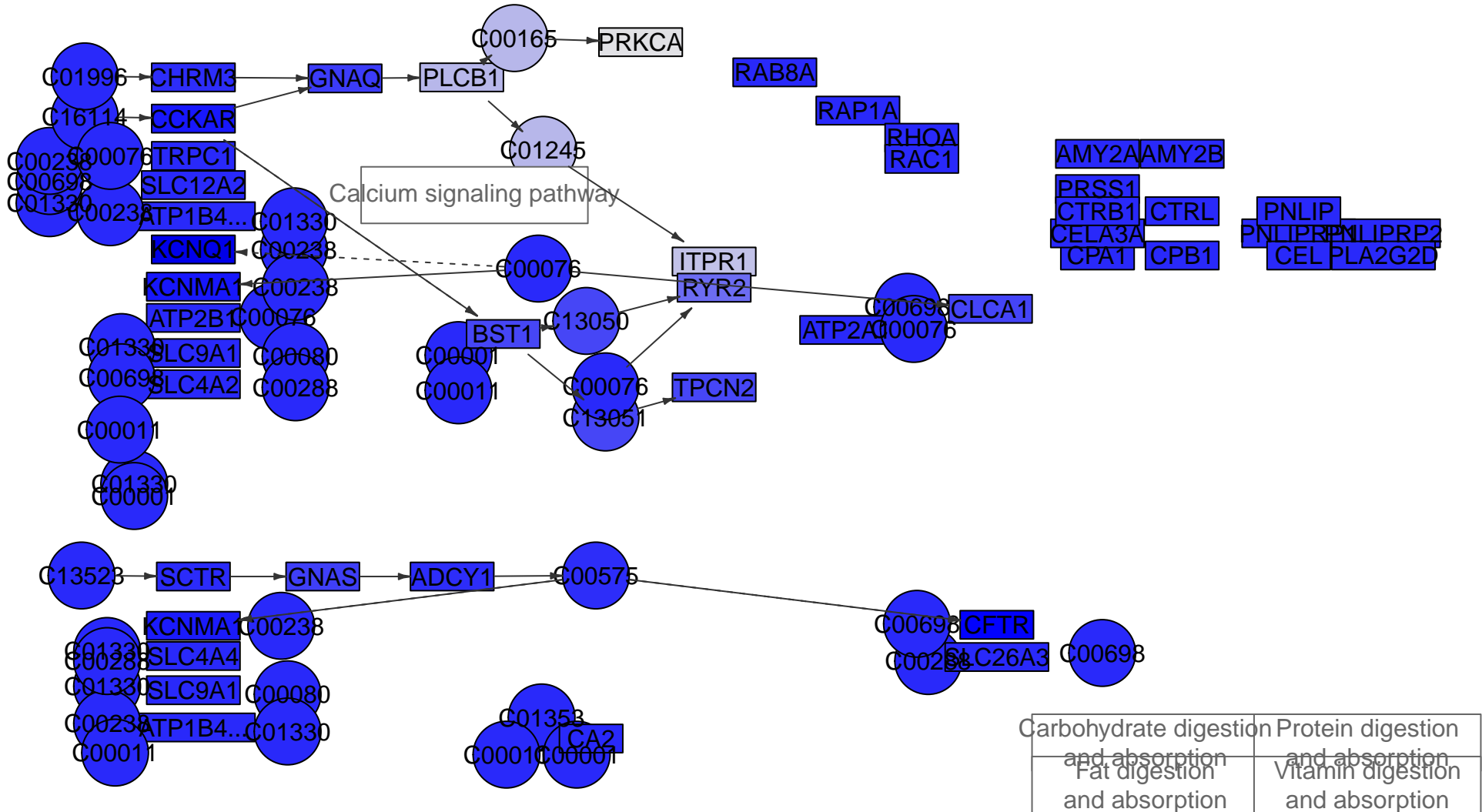

Pancreatic secretion
MPI-033



Tight junction

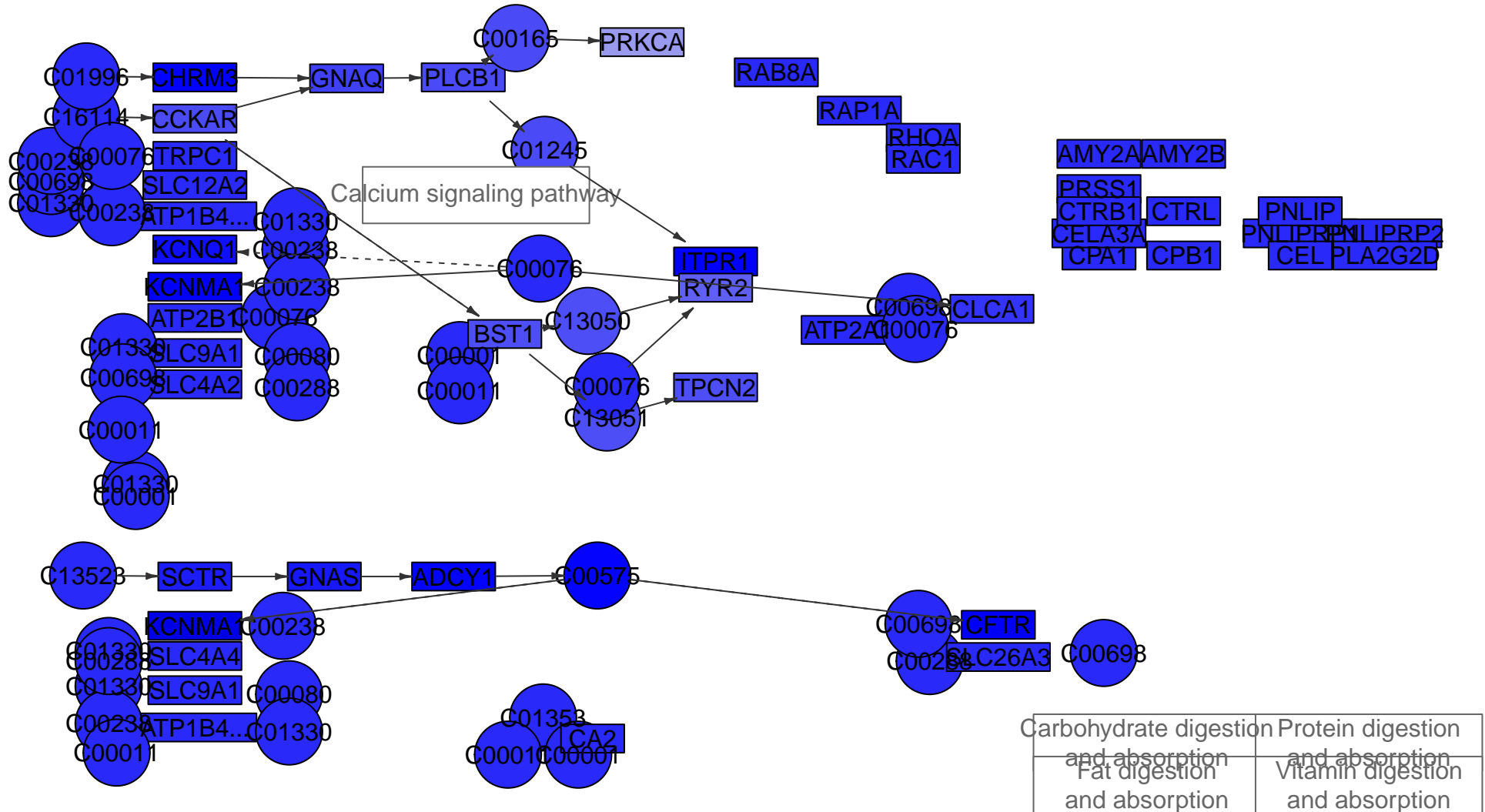

Carbohydrate digestion and absorption	Protein digestion and absorption
Fat digestion and absorption	Vitamin digestion and absorption

Pancreatic secretion
MPI-034

Tight junction

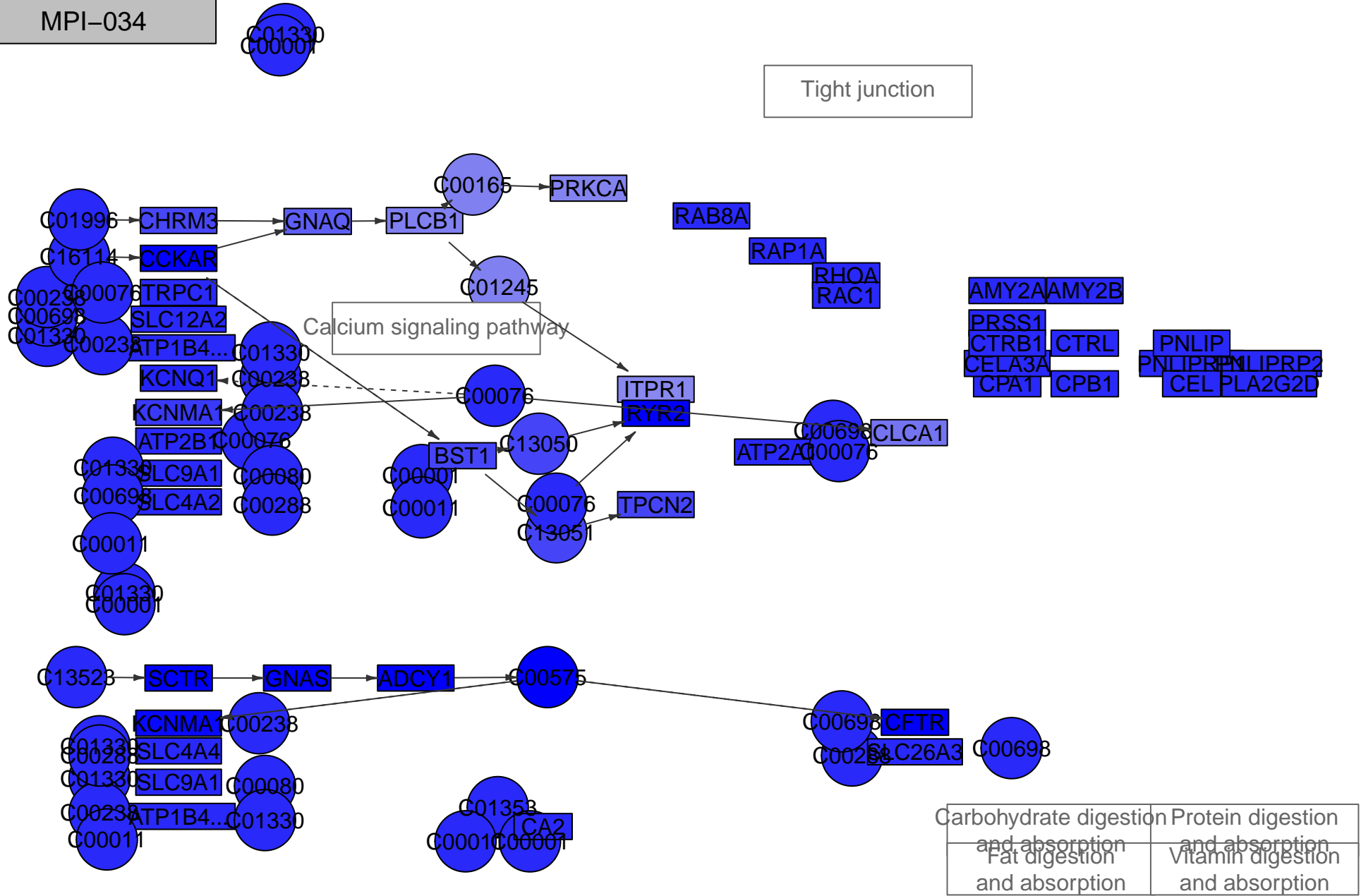

Pancreatic secretion
MPI-043



Tight junction

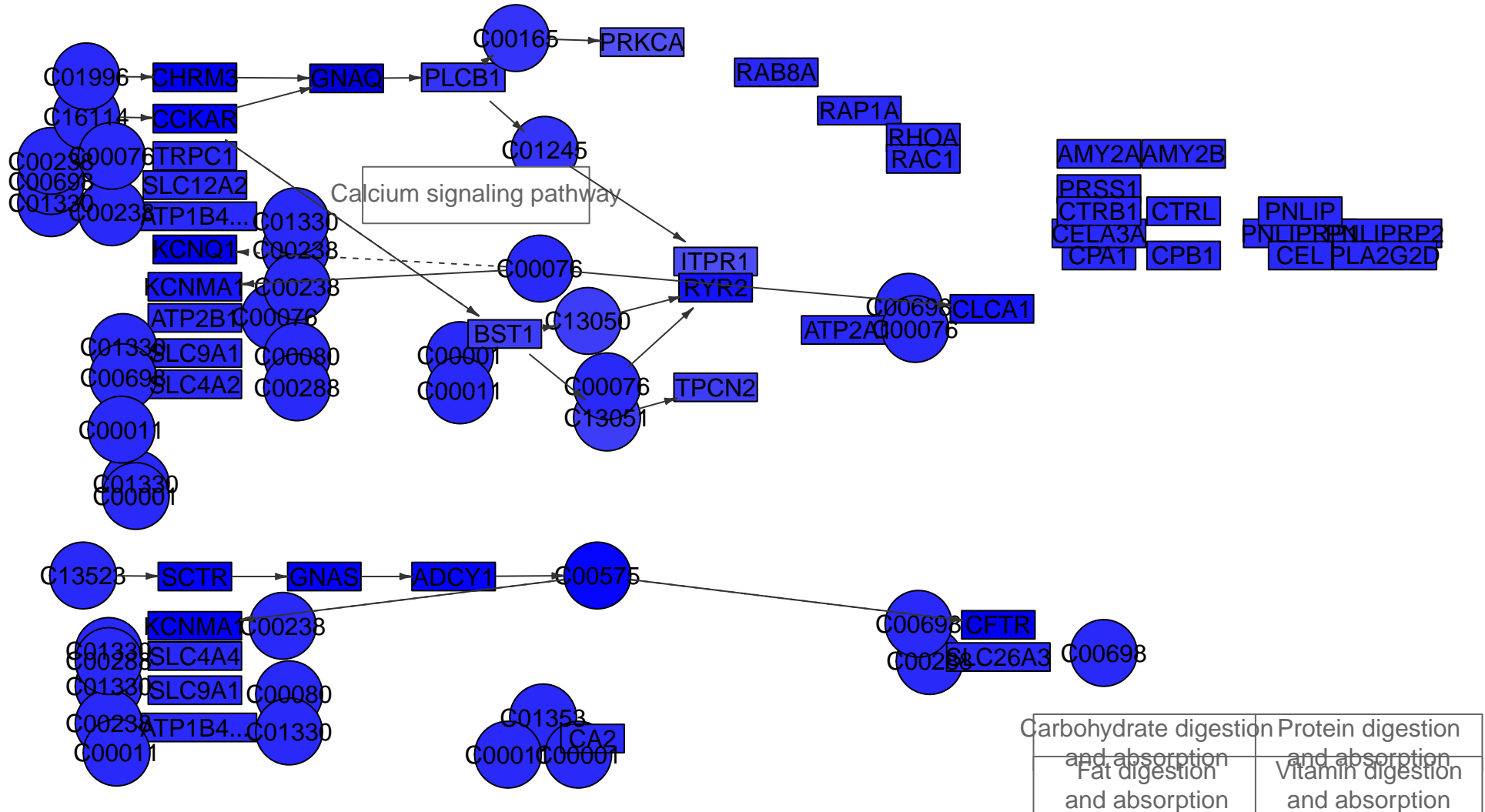

Pancreatic secretion
MPI-044



Tight junction

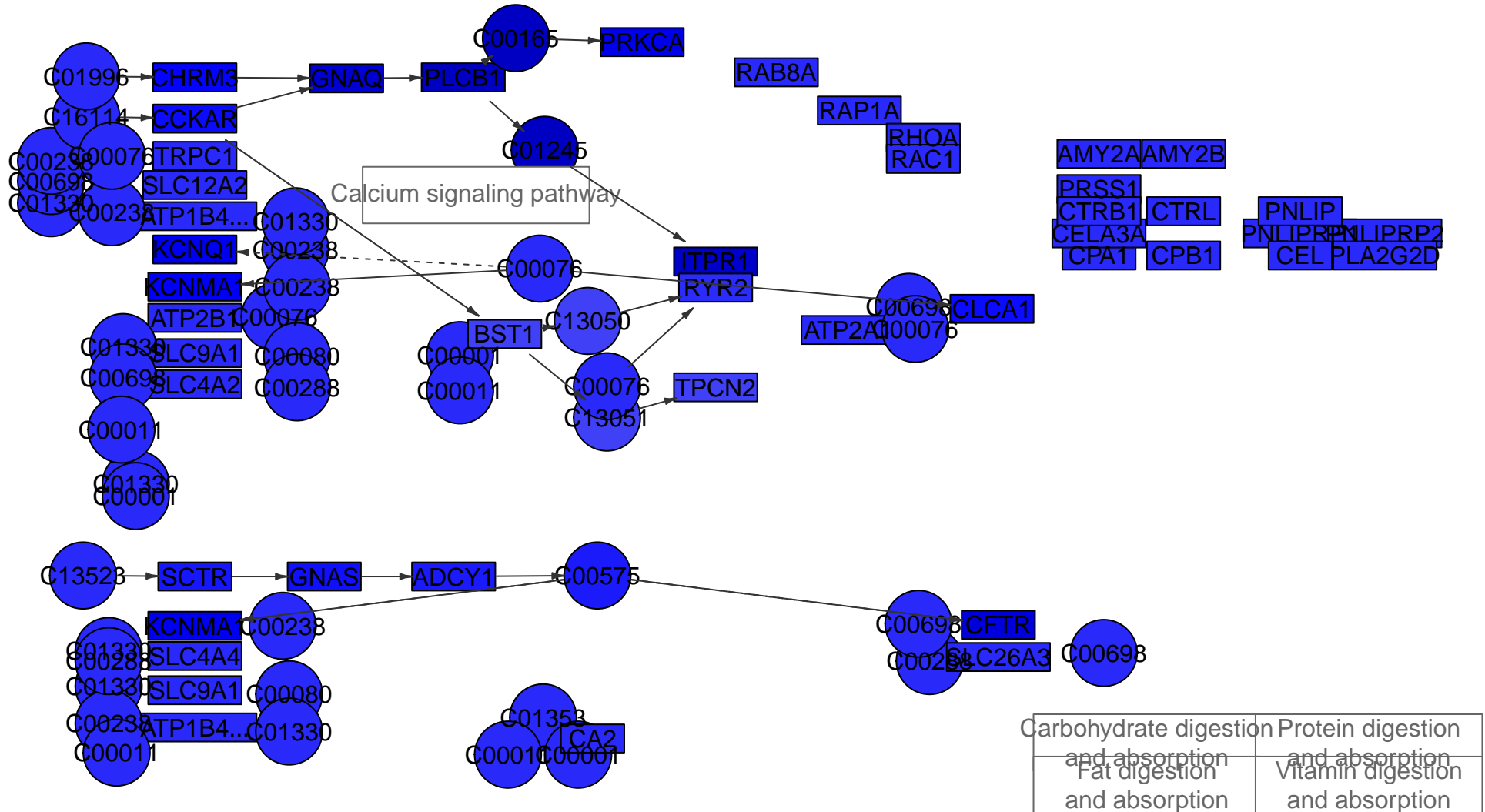

Pancreatic secretion
MPI-048



Tight junction

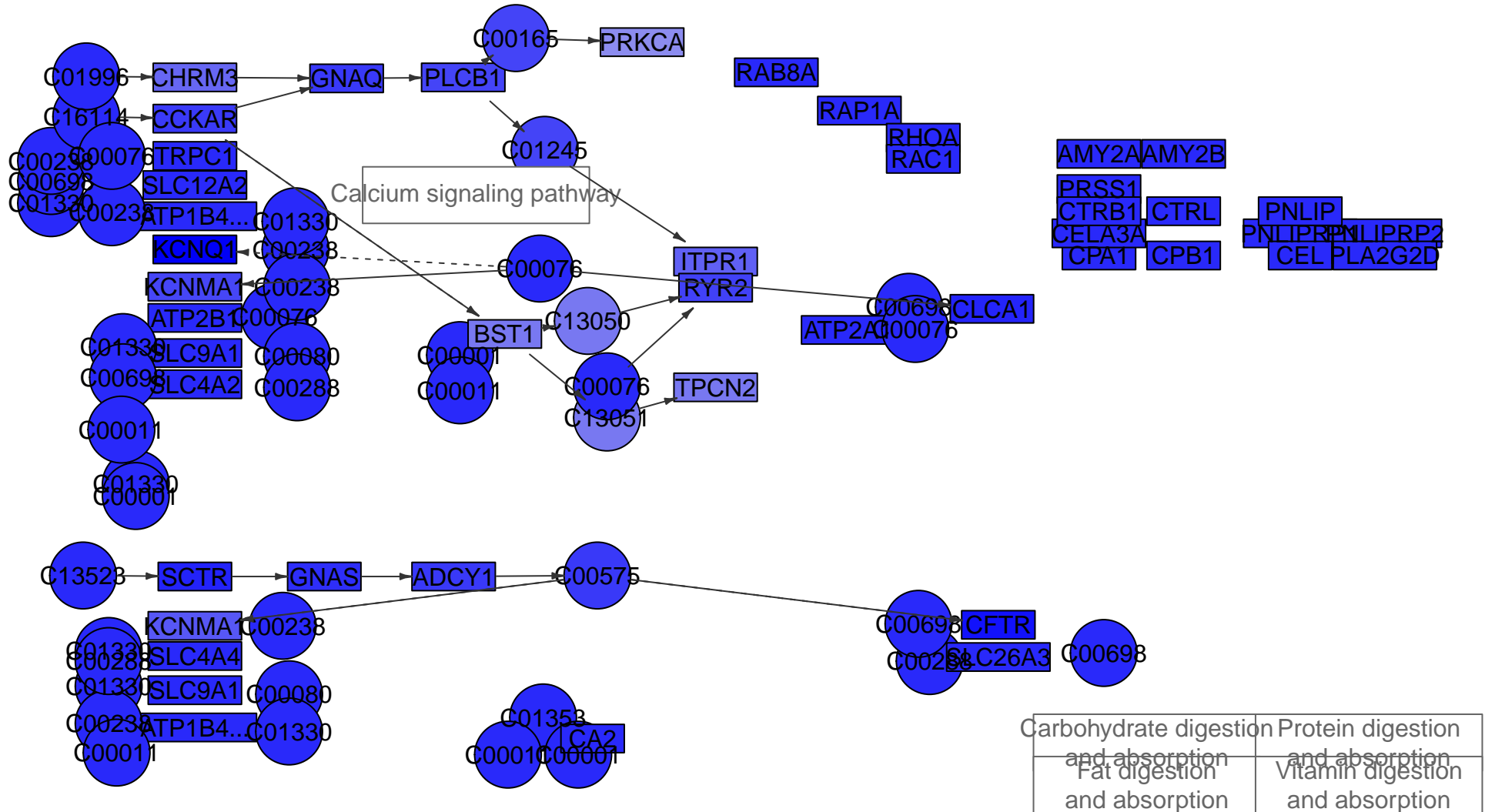

Pancreatic secretion
MPI-055



Tight junction

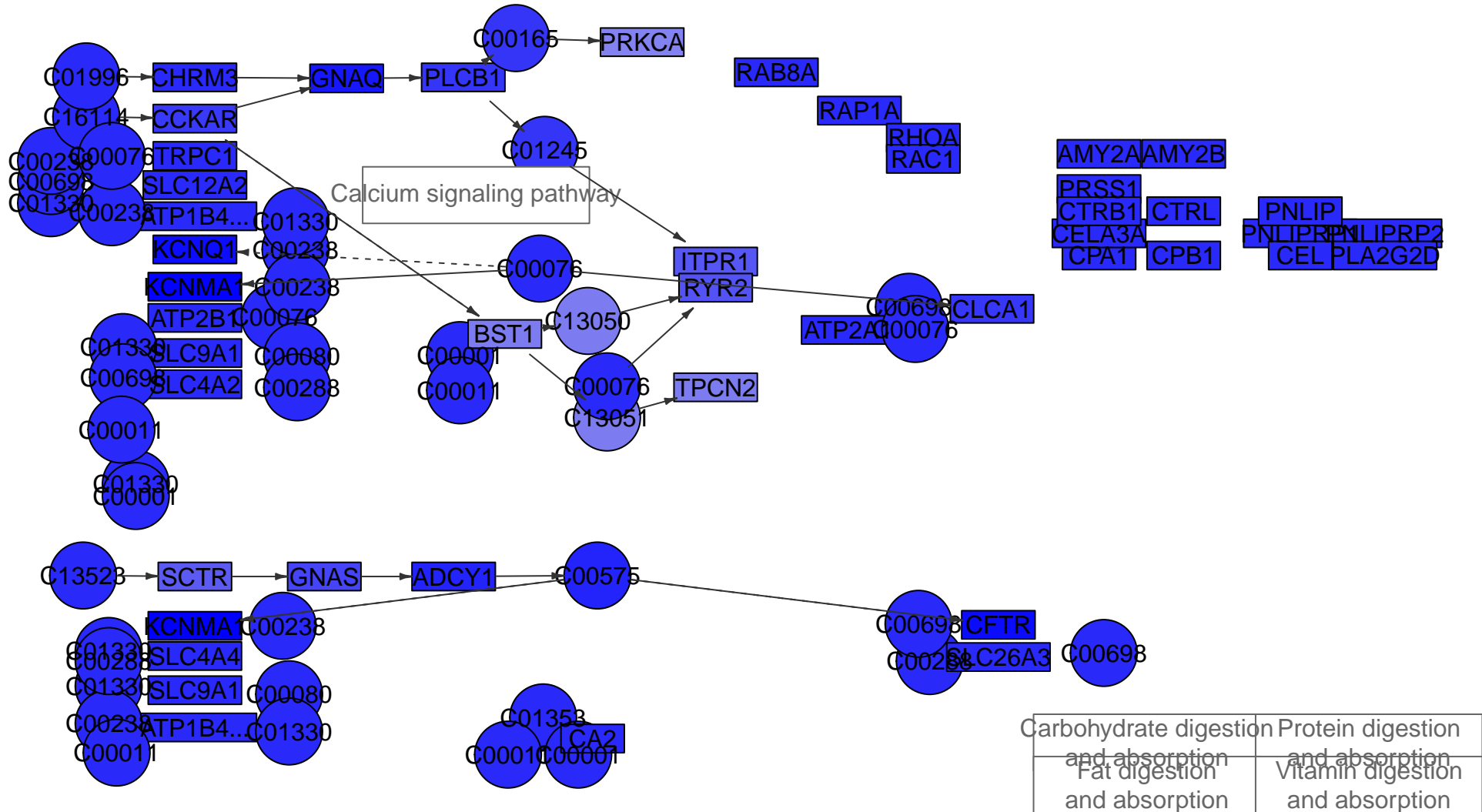

Pancreatic secretion
MPI-065



Tight junction

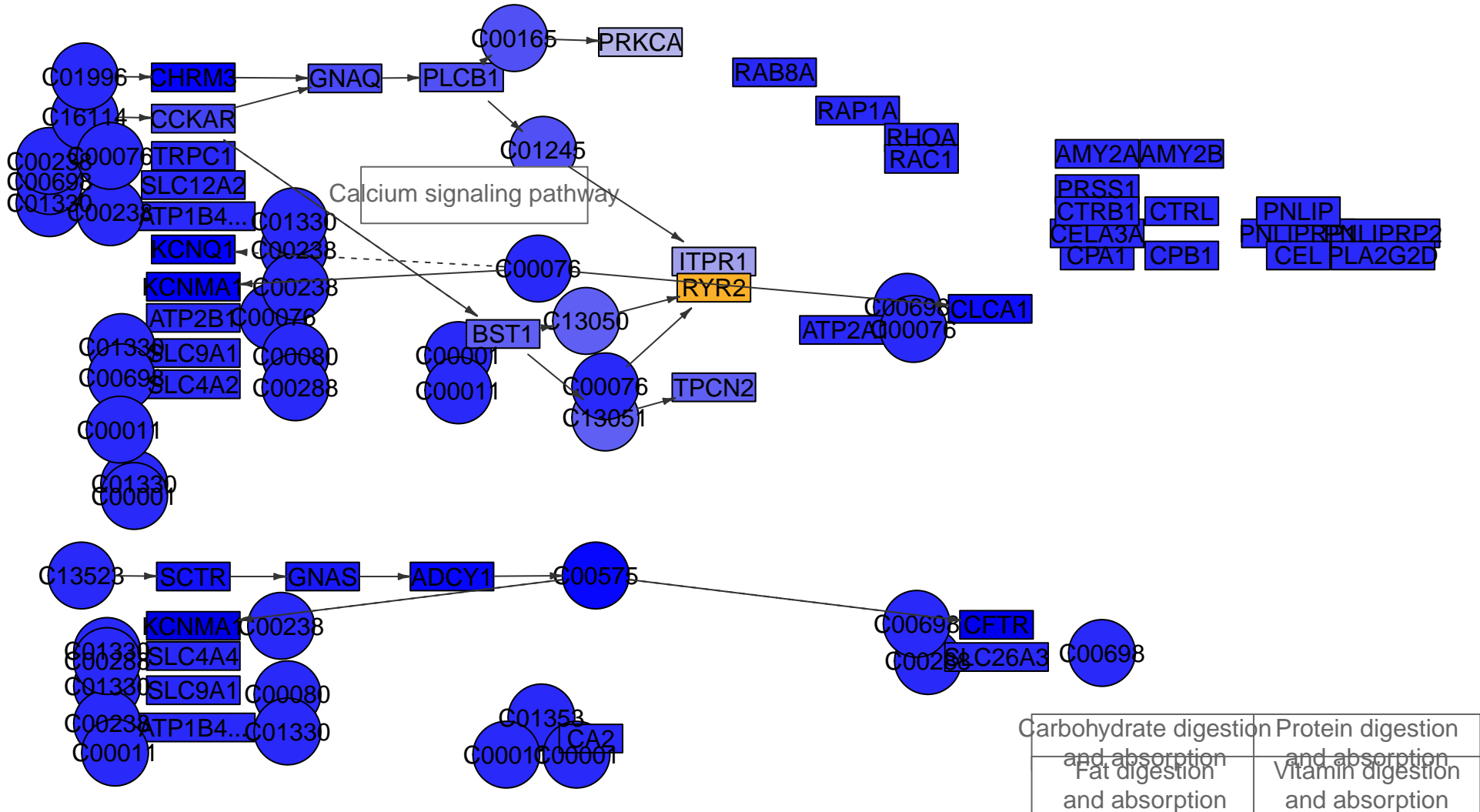

Pancreatic secretion
MPI-071



Tight junction

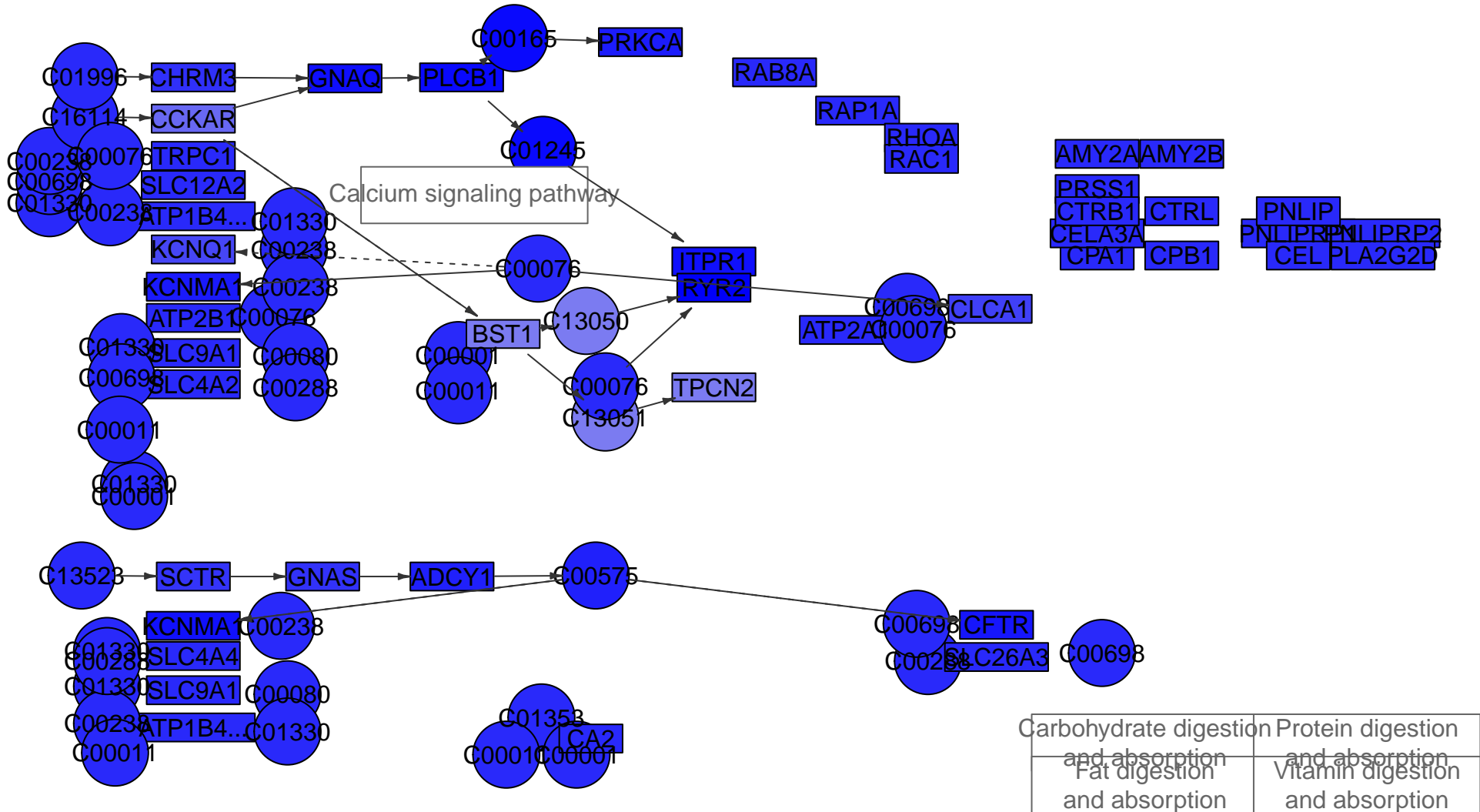

Pancreatic secretion
MPI-075



Tight junction

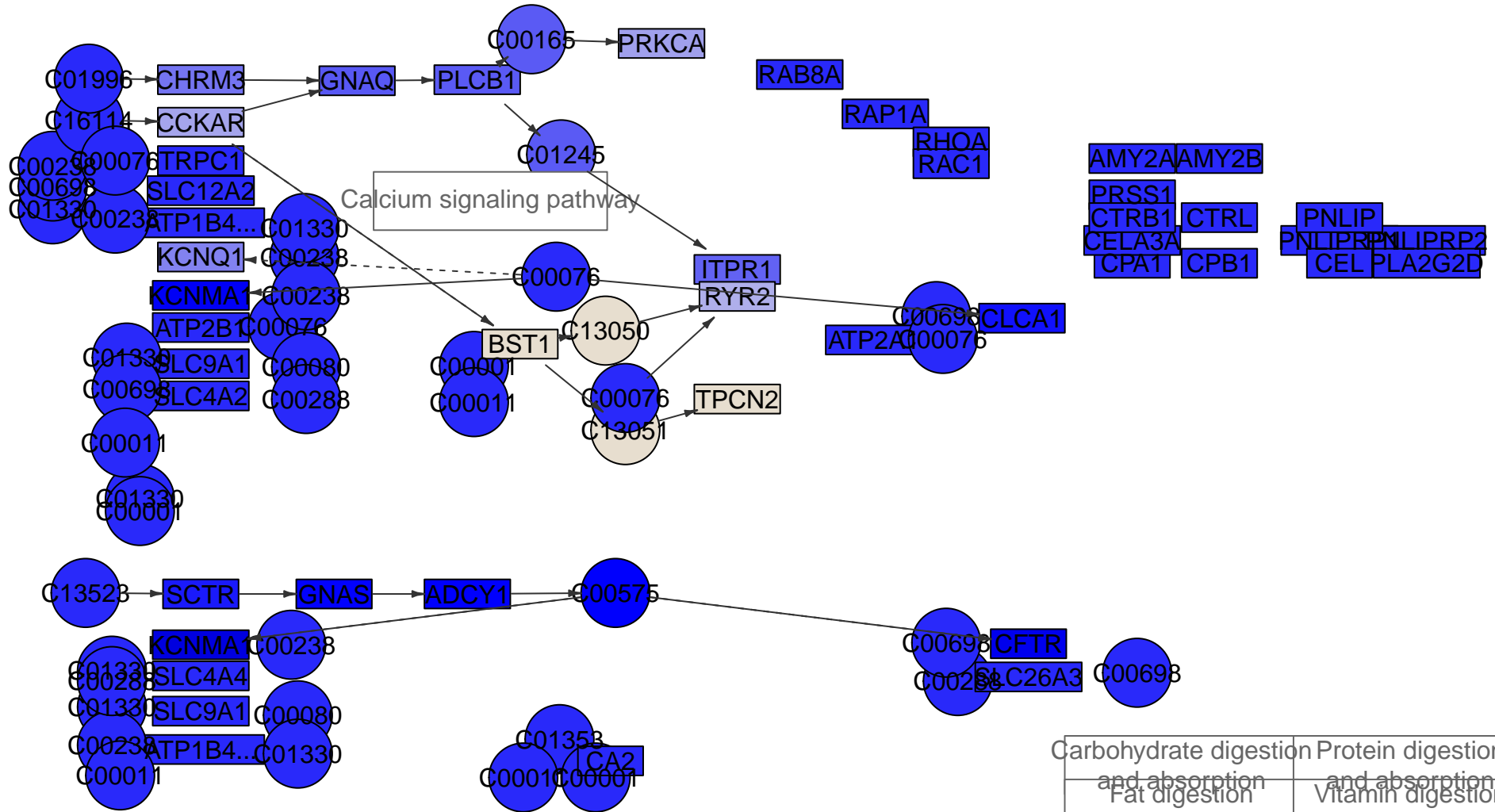

Carbohydrate digestion and absorption	Protein digestion and absorption
Fat digestion and absorption	Vitamin digestion and absorption

Pancreatic secretion
MPI-077



Tight junction

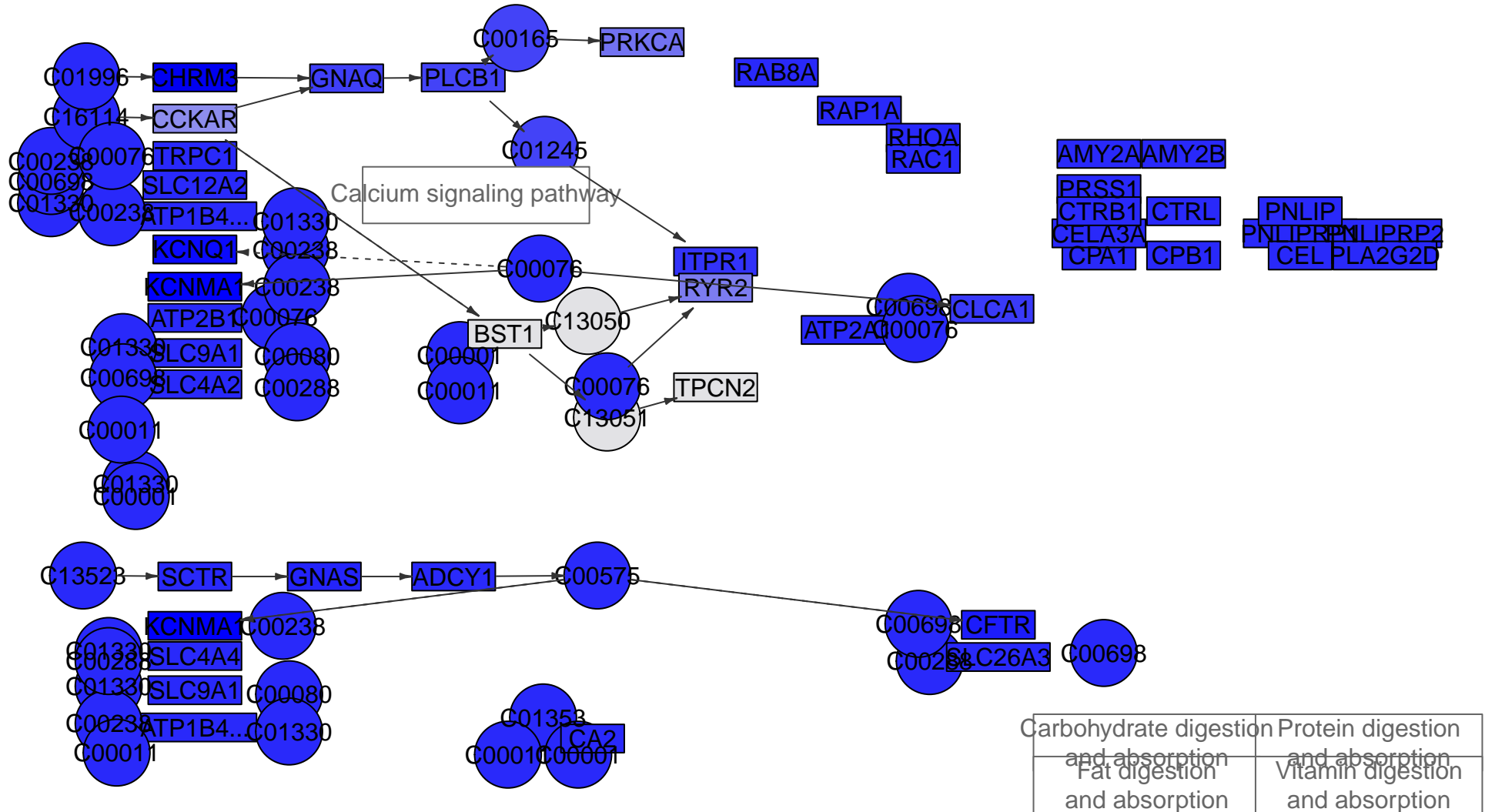

Pancreatic secretion
MPI-078



Tight junction

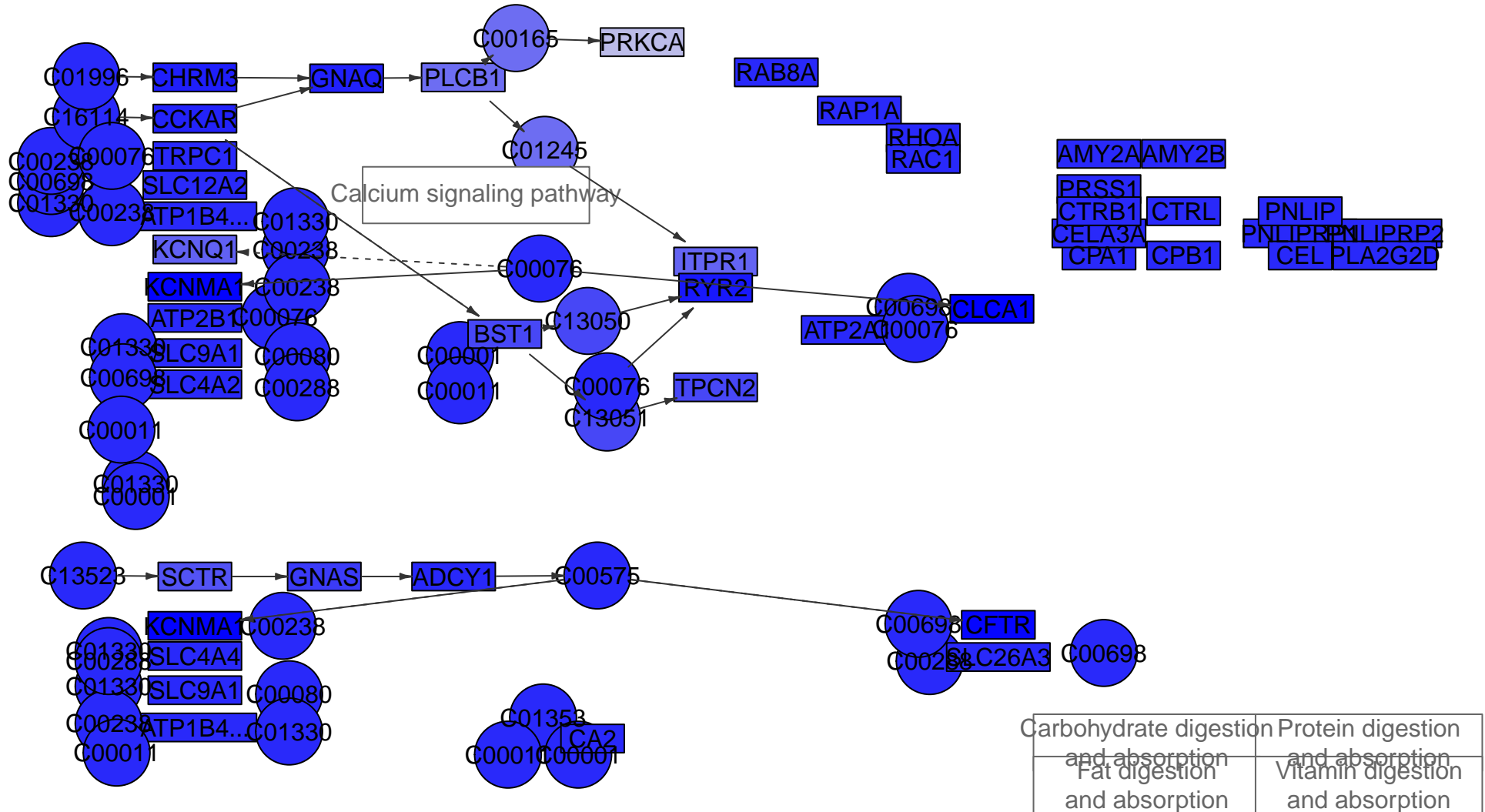

Pancreatic secretion
MPI-079



Tight junction

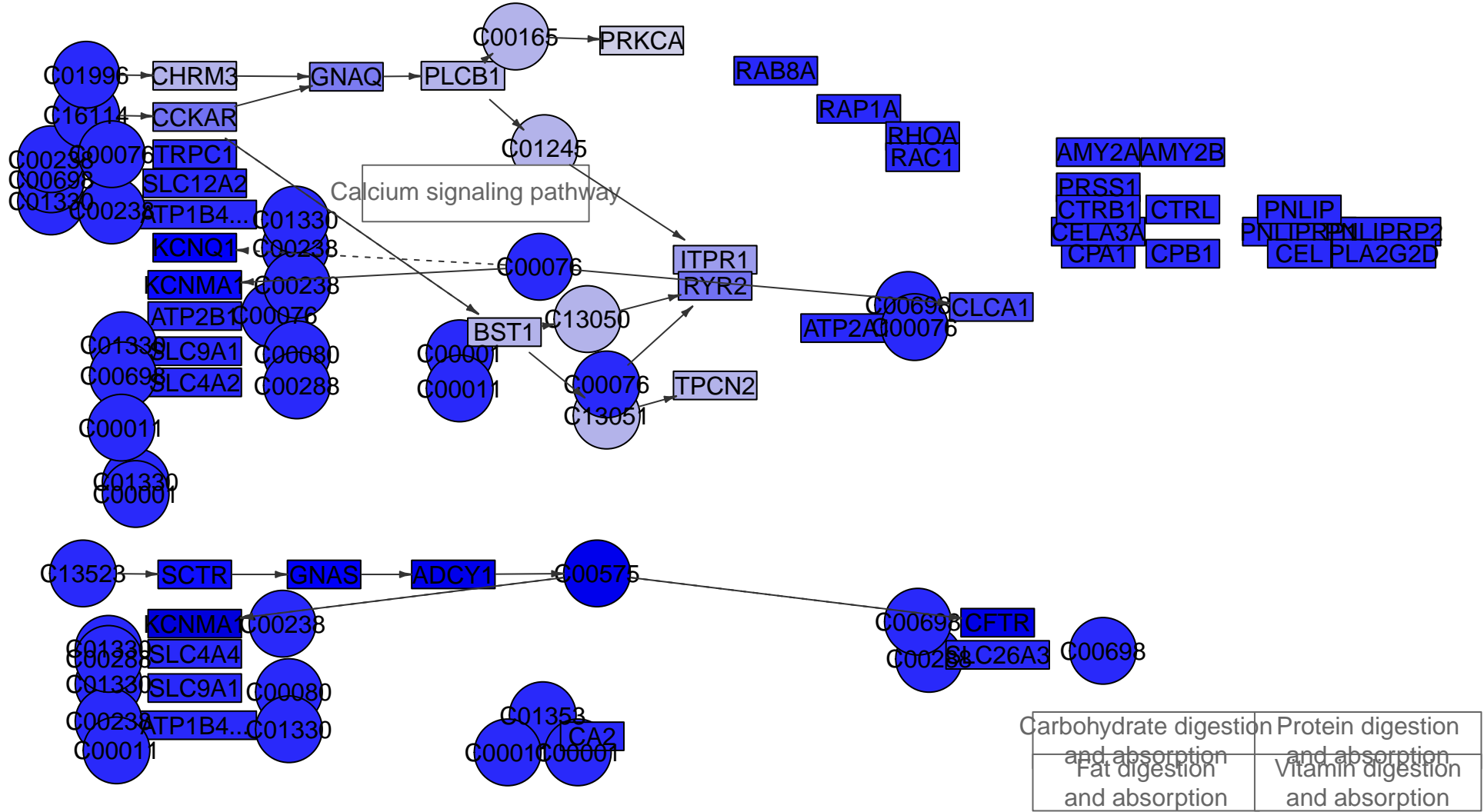

Pancreatic secretion
MPI-080

Tight junction

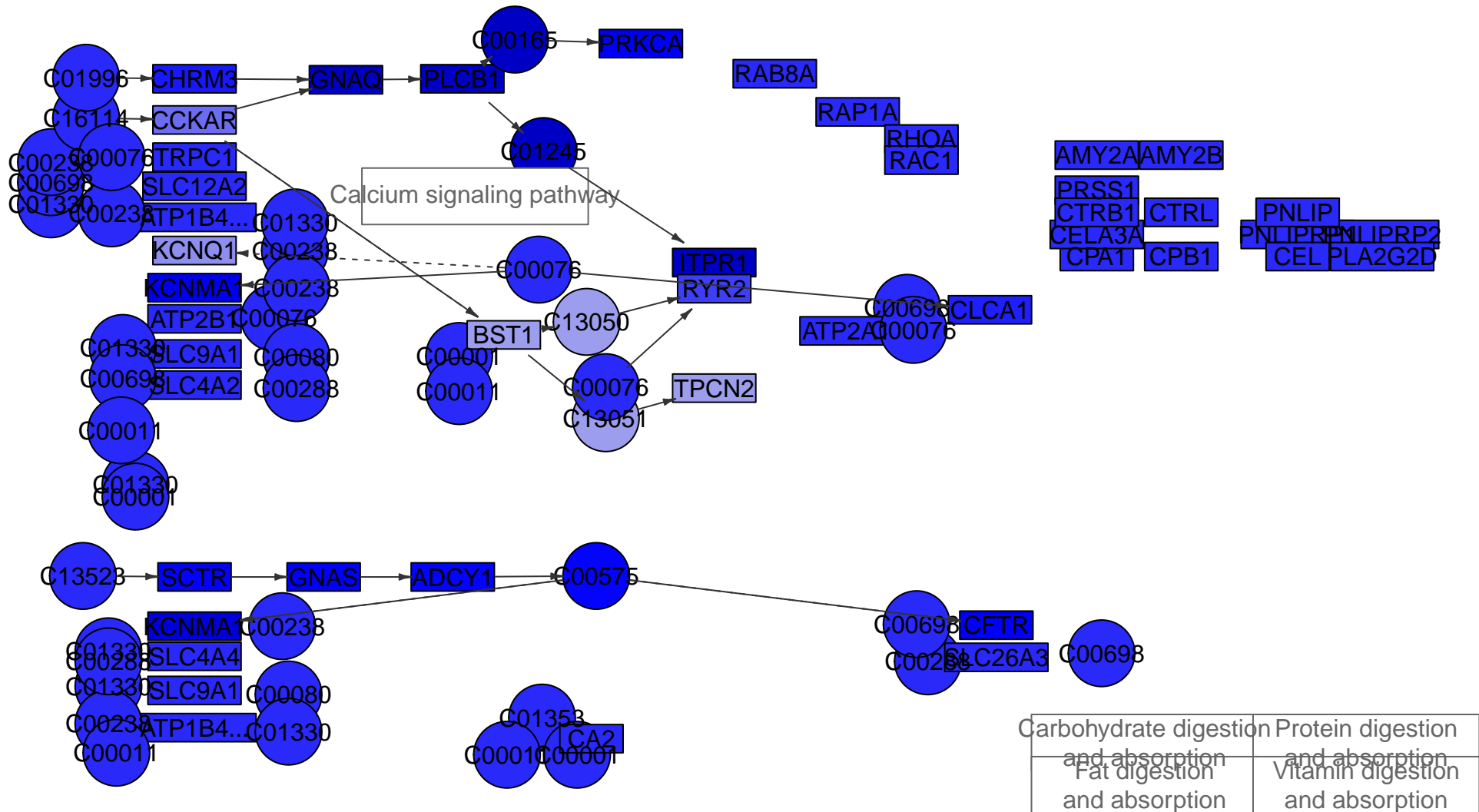

Carbohydrate digestion and absorption	Protein digestion and absorption
Fat digestion and absorption	Vitamin digestion and absorption

Pancreatic secretion
MPI-081



Tight junction

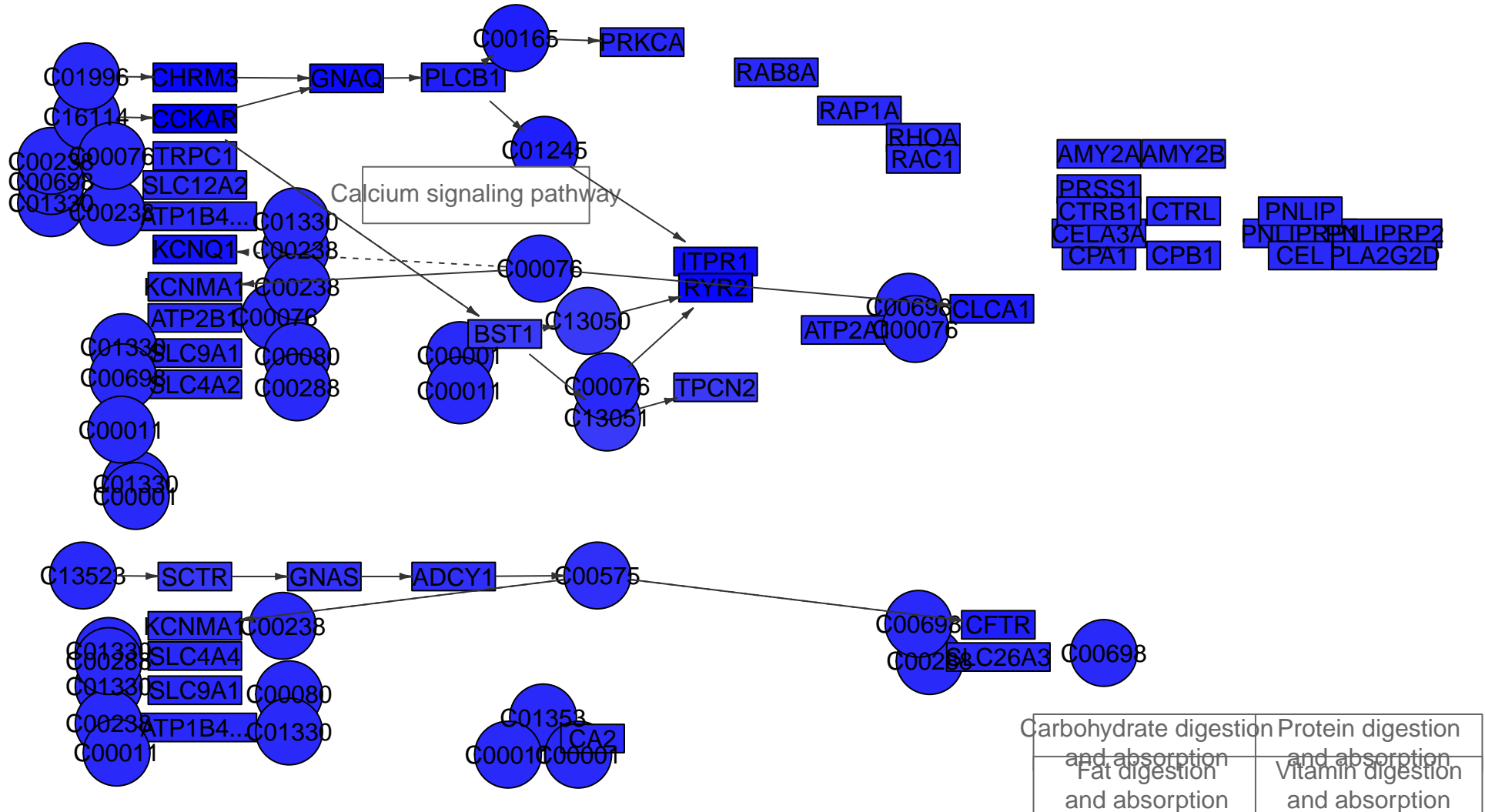

Pancreatic secretion
MPI-082



Tight junction

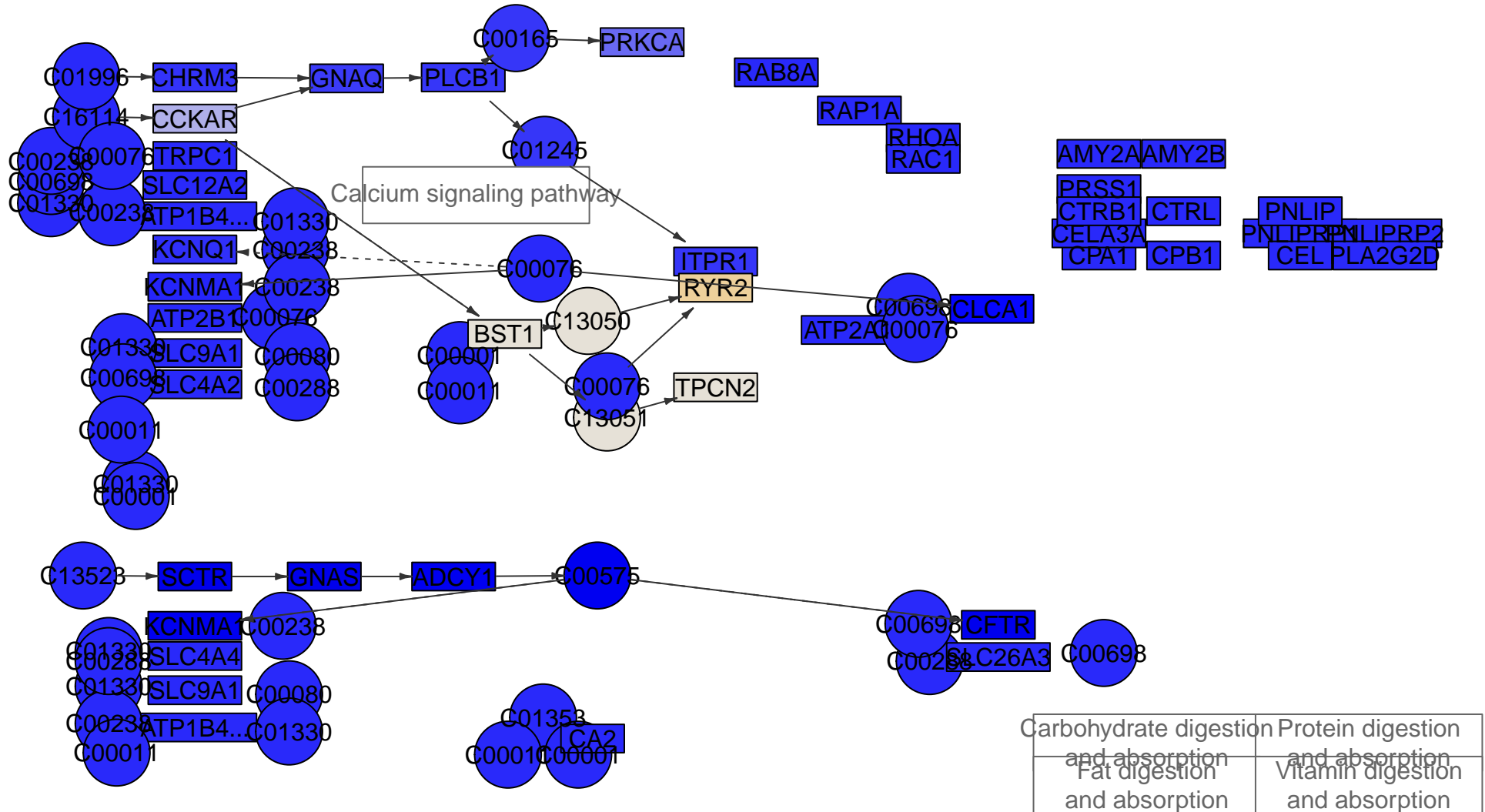

Pancreatic secretion
MPI-084



Tight junction

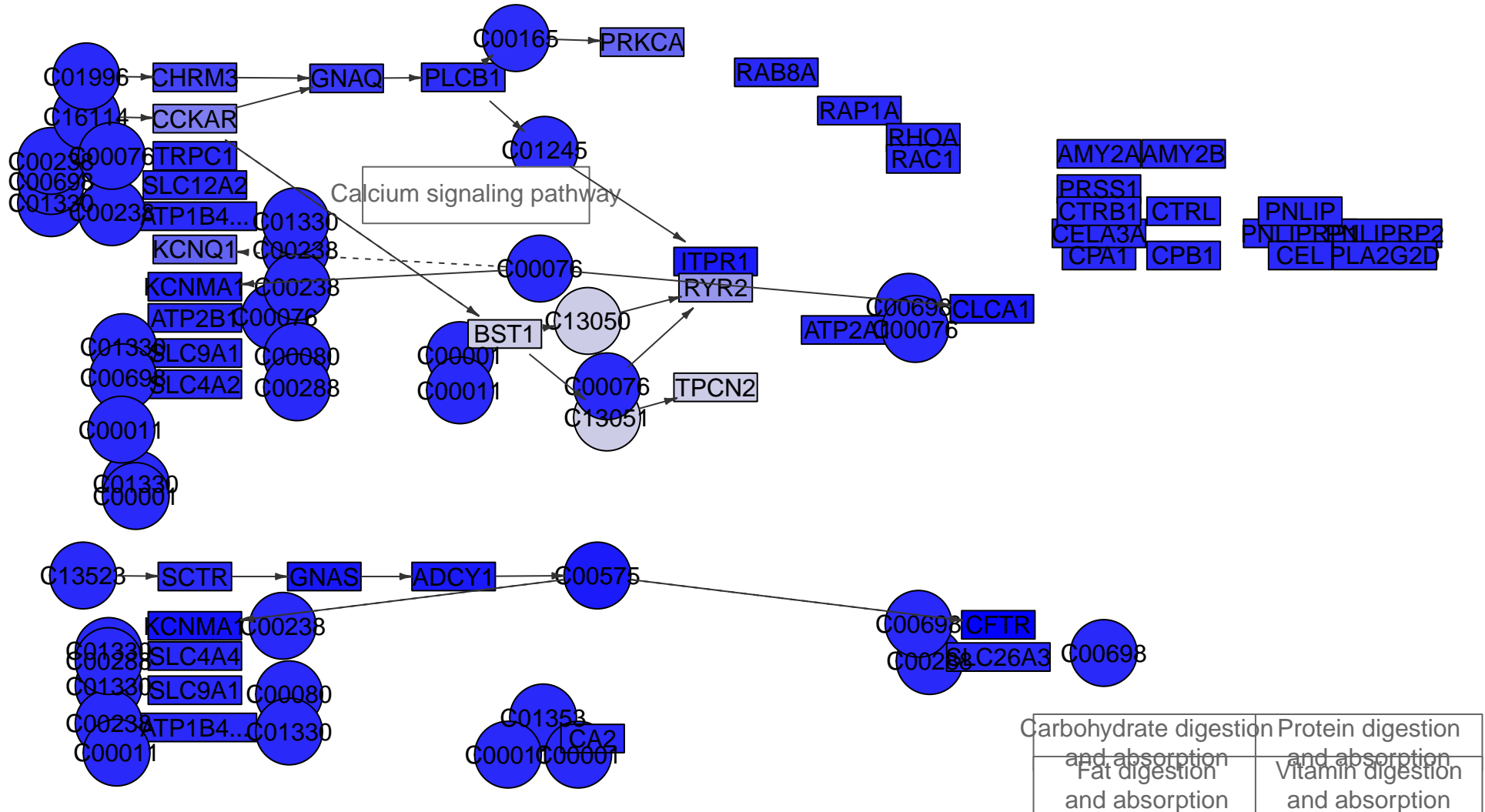

Pancreatic secretion
MPI-085



Tight junction

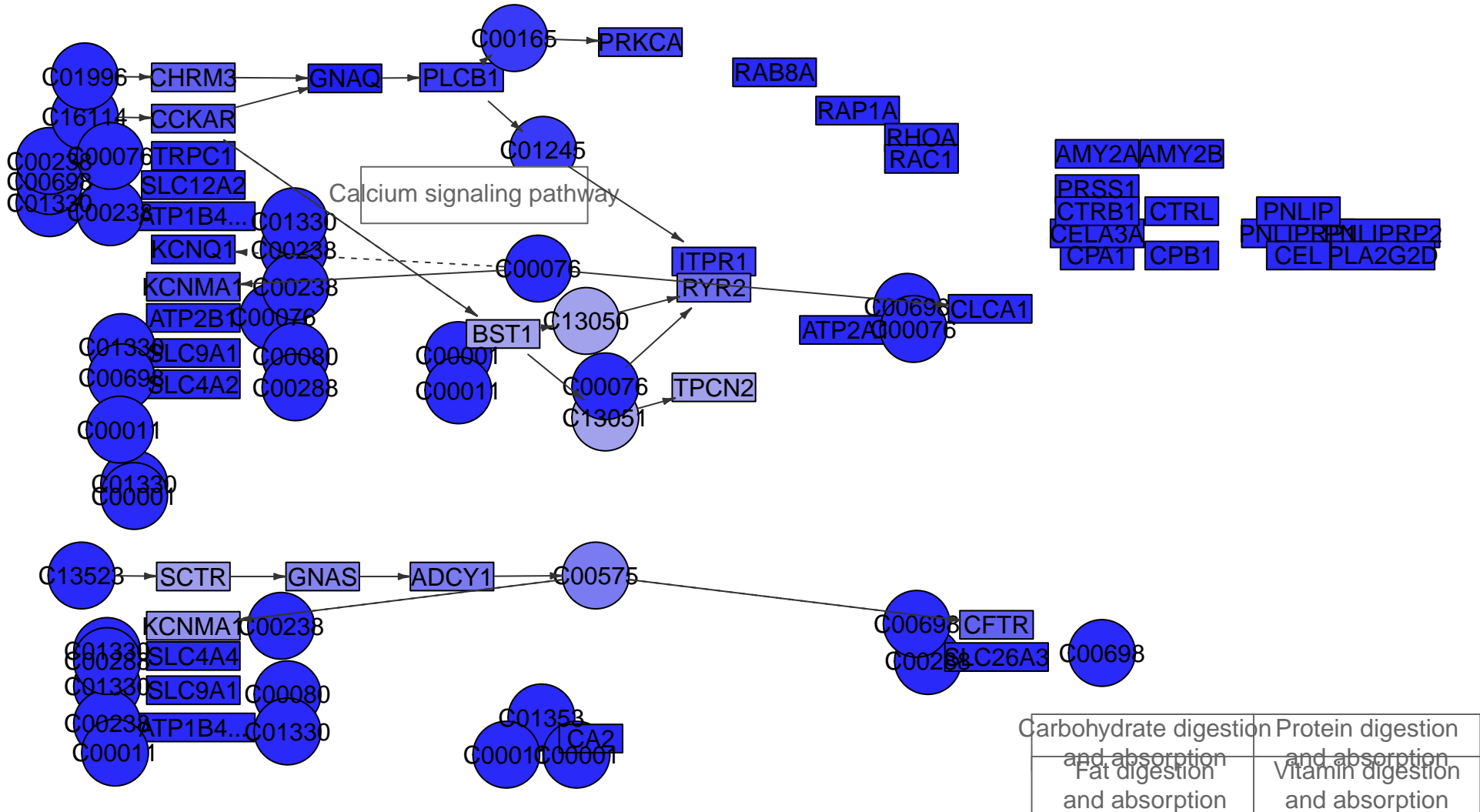

Pancreatic secretion
MPI-086

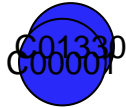

Tight junction

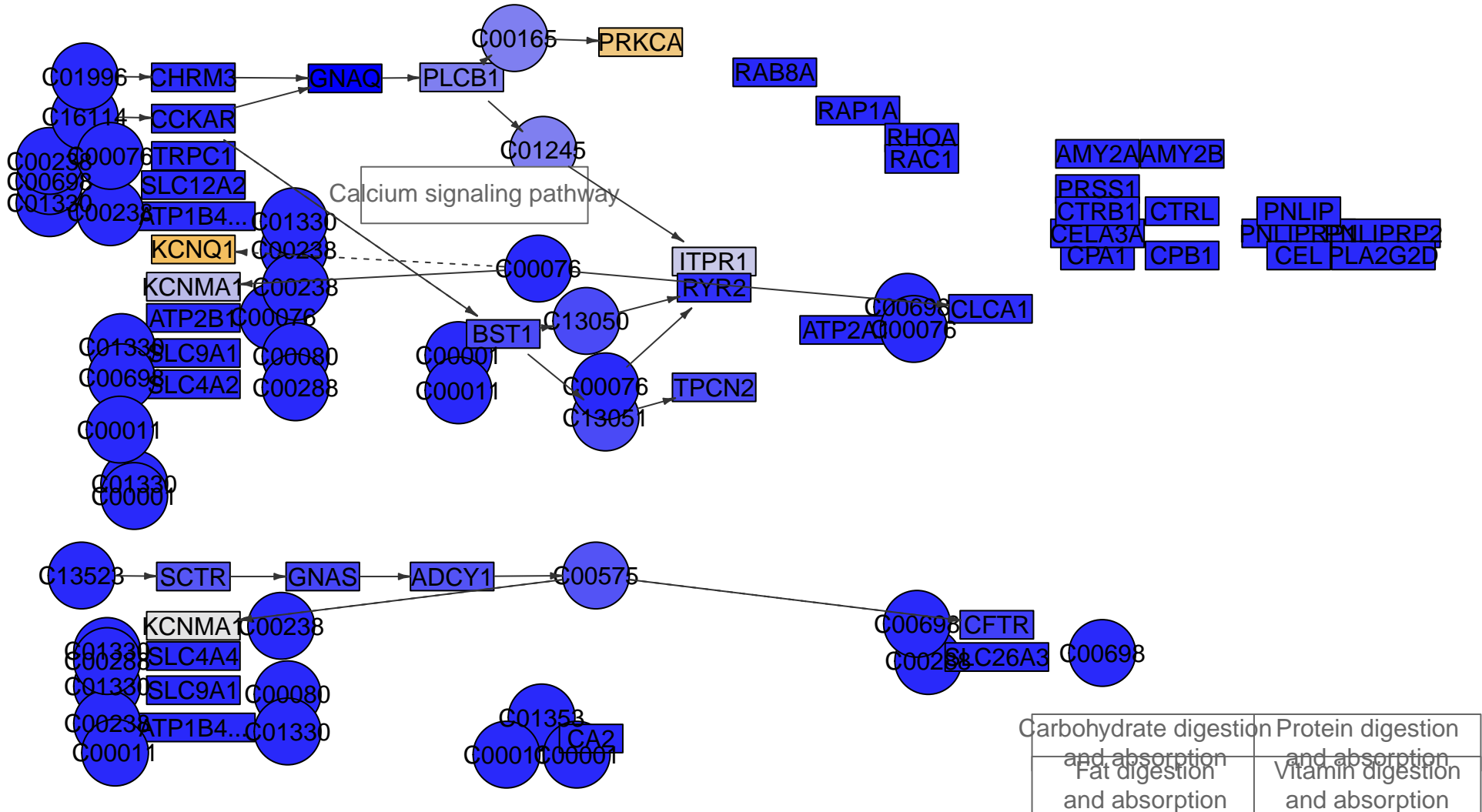

Pancreatic secretion
MPI-089



Tight junction

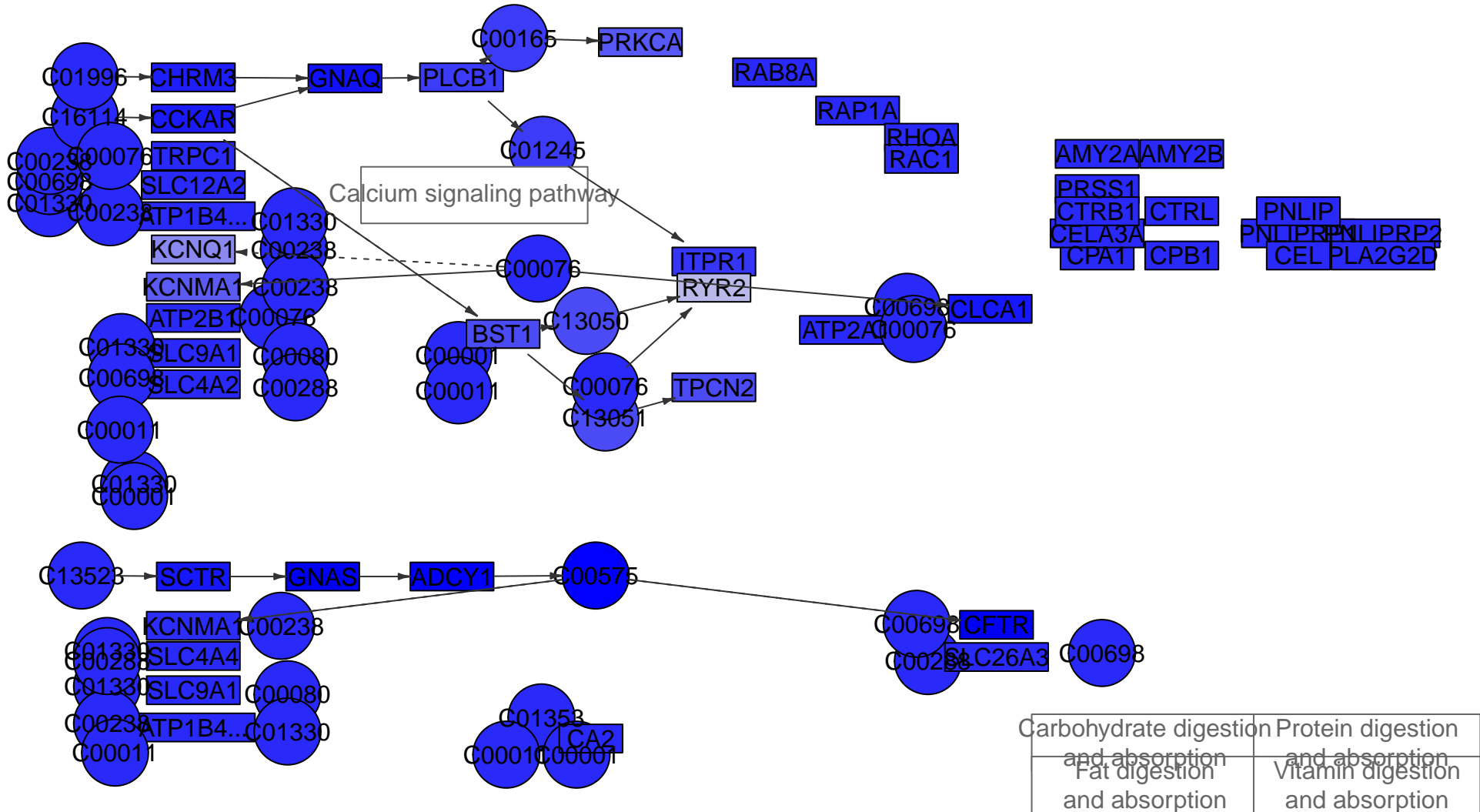

Pancreatic secretion
MPI-090



Tight junction

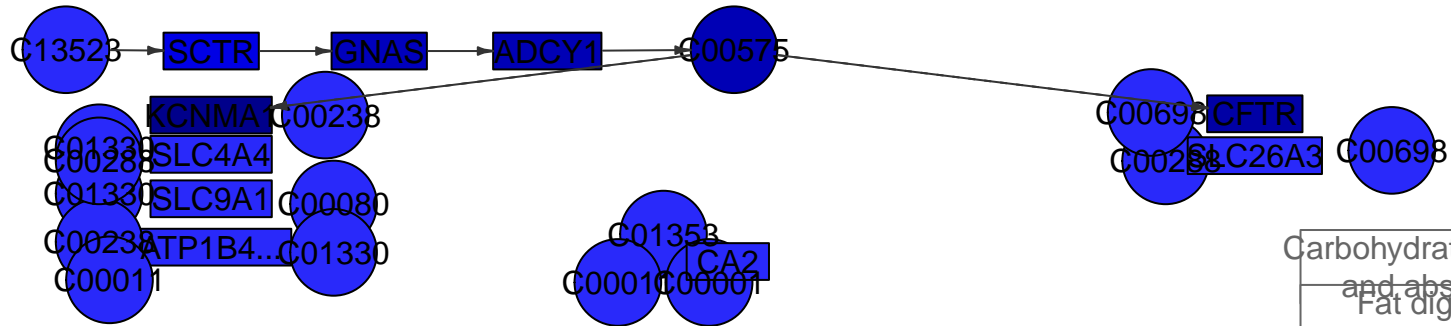
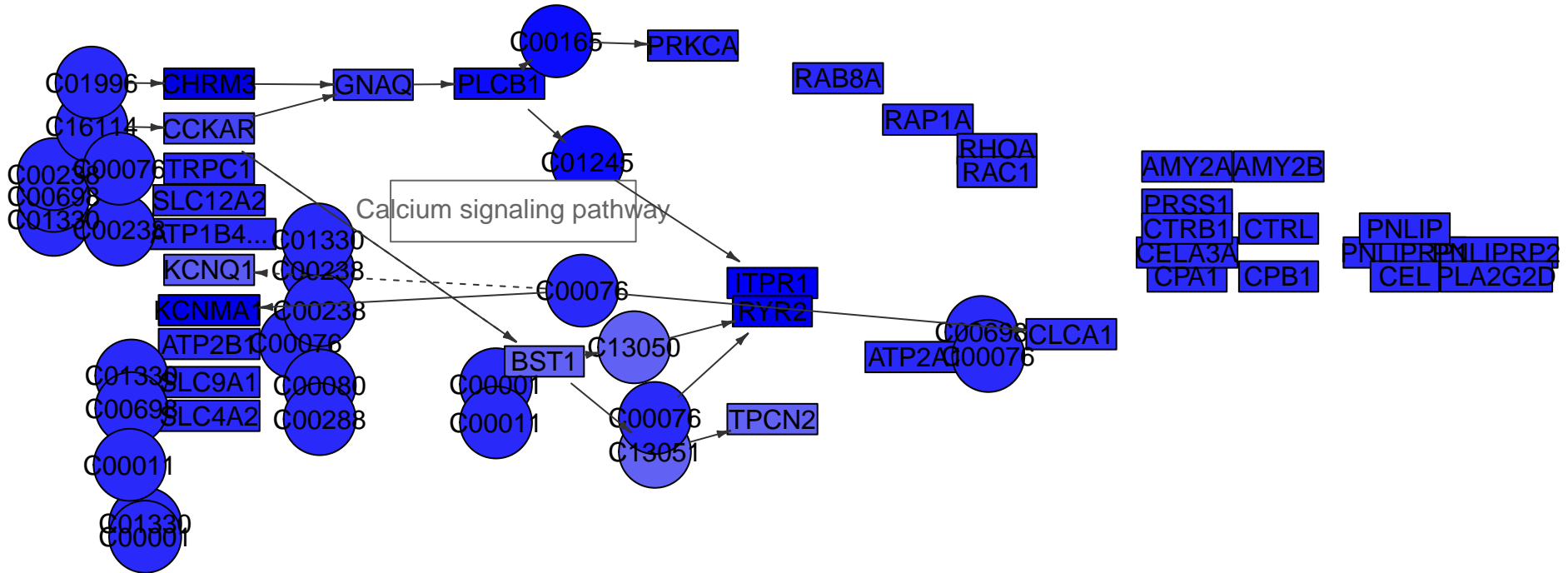

Carbohydrate digestion and absorption	Protein digestion and absorption
Fat digestion and absorption	Vitamin digestion and absorption

Pancreatic secretion
MPI-091



Tight junction

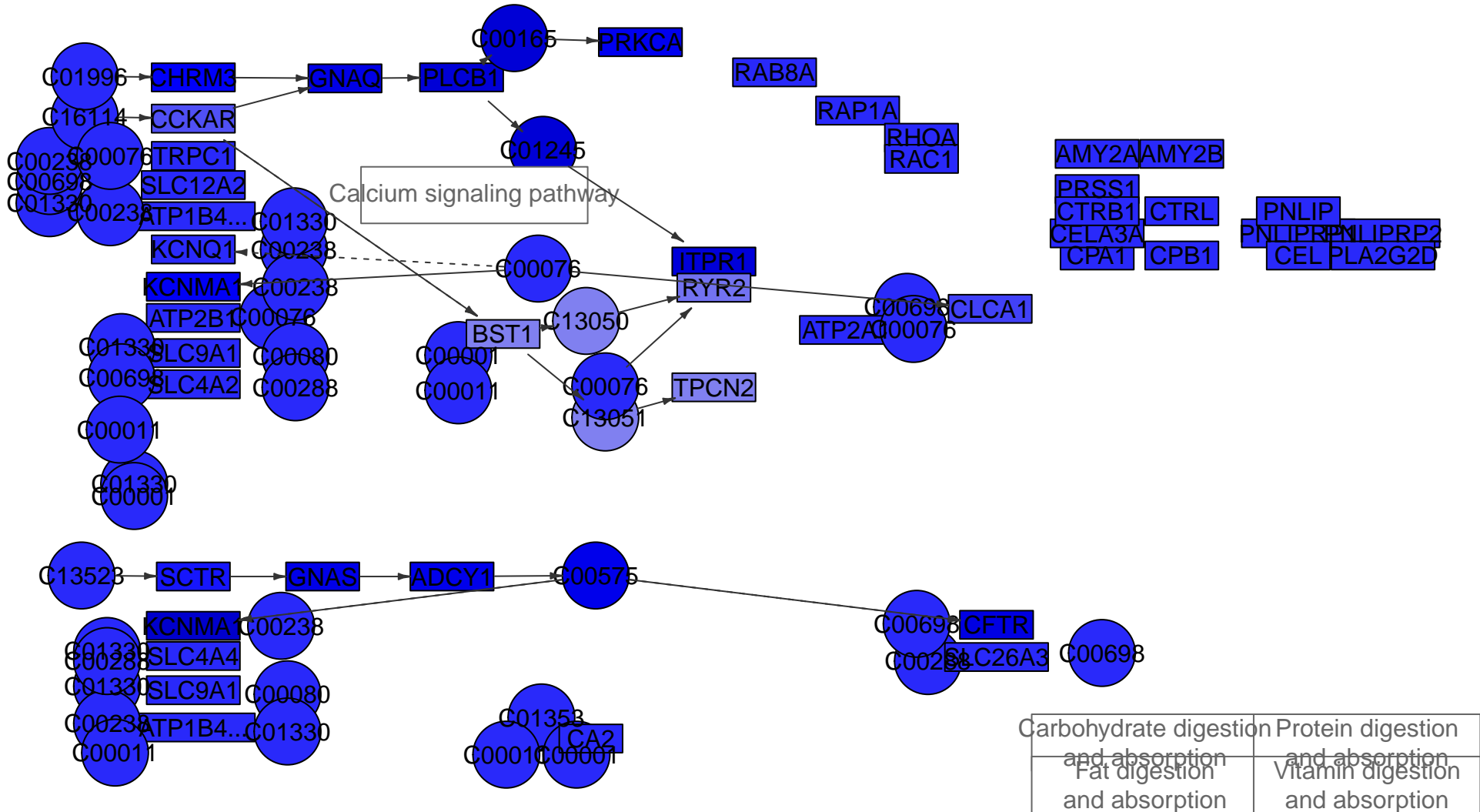

Pancreatic secretion
MPI-095



Tight junction

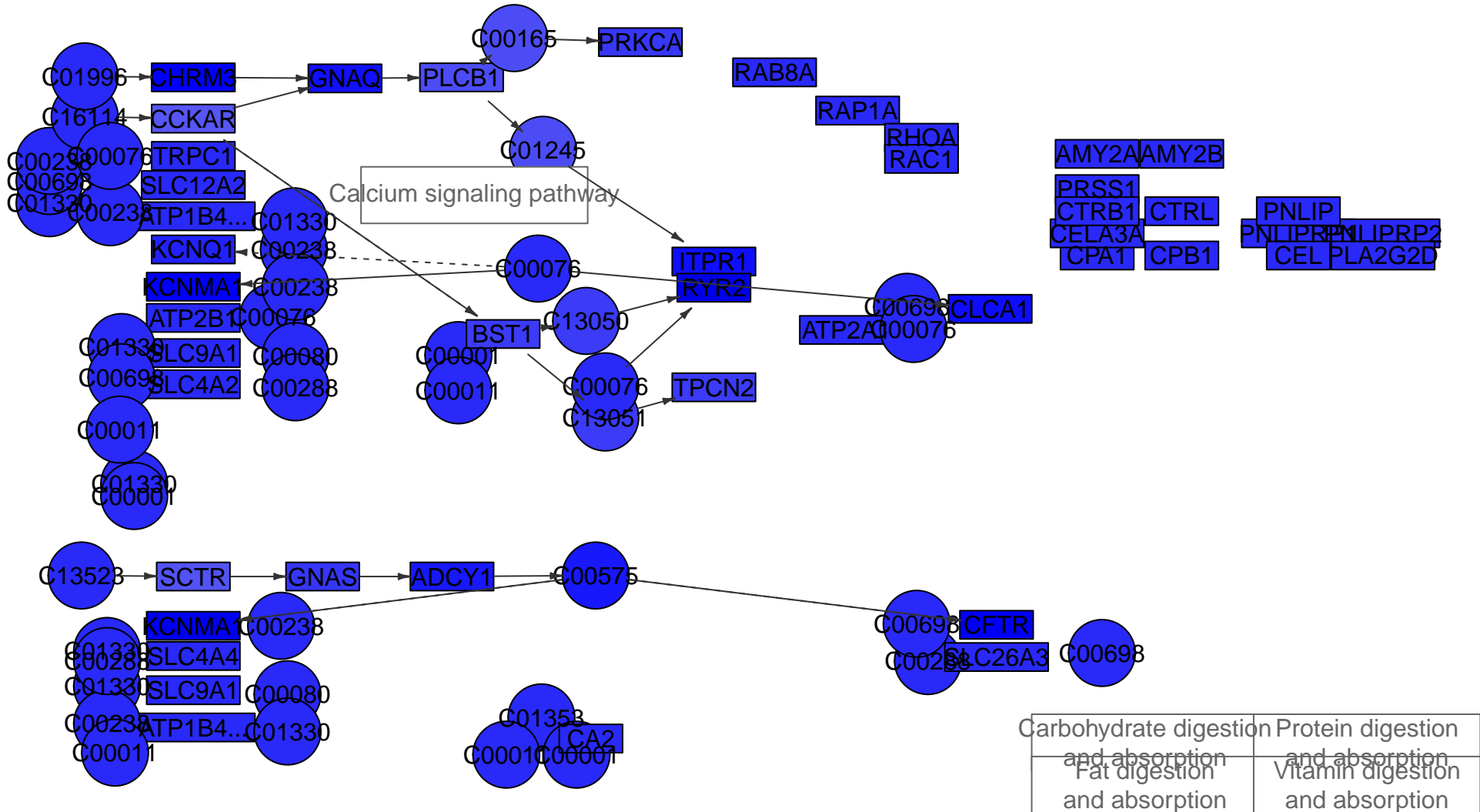

Pancreatic secretion
MPI-101



Tight junction

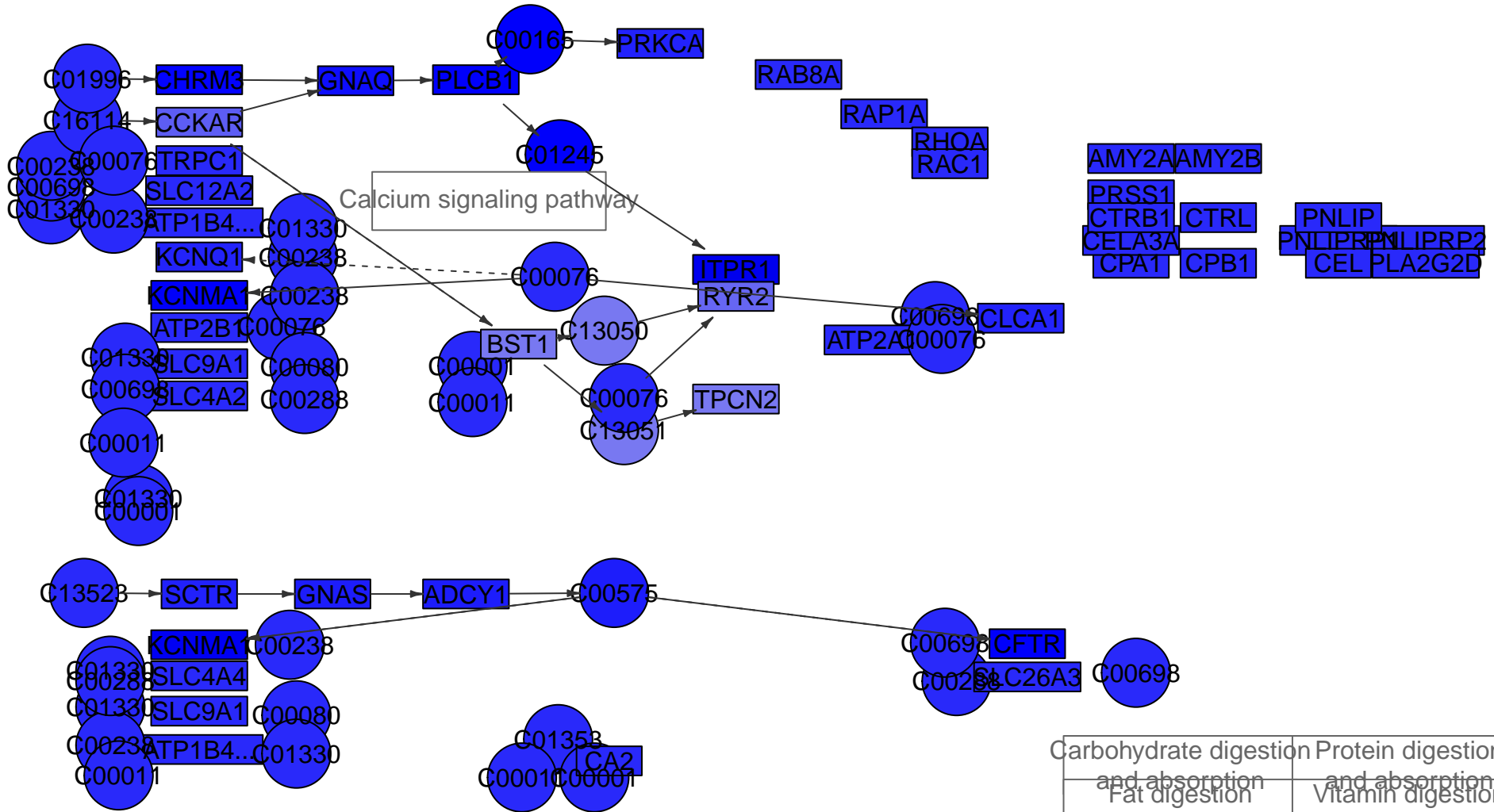

C01996 → CHRM3 → GNAQ → PLCB1 → PRKCA

C16114 → CCKAR → GNAQ → PLCB1 → PRKCA

C00298 → TRPC1 → GNAQ → PLCB1 → PRKCA
C00698 → SLC12A2 → GNAQ → PLCB1 → PRKCA
C01330 → ATP1B4... → GNAQ → PLCB1 → PRKCA

C01330 → KCNQ1 → GNAQ → PLCB1 → PRKCA

C01330 → KCNMA1 → GNAQ → PLCB1 → PRKCA

C01330 → ATP2B1 → GNAQ → PLCB1 → PRKCA

C01330 → SLC9A1 → GNAQ → PLCB1 → PRKCA

C00698 → SLC4A2 → GNAQ → PLCB1 → PRKCA

C00011 → GNAQ → PLCB1 → PRKCA

C01330 → GNAQ → PLCB1 → PRKCA

C13523 → SCTR → GNAS → ADCY1 → G00575 → CFTR

C01330 → KCNMA1 → GNAS → ADCY1 → G00575 → CFTR

C00288 → SLC4A4 → GNAS → ADCY1 → G00575 → CFTR

C01330 → SLC9A1 → GNAS → ADCY1 → G00575 → CFTR

C00238 → ATP1B4... → GNAS → ADCY1 → G00575 → CFTR

C00165 → PRKCA

C01245 → ITPR1

C00076 → ITPR1

C00076 → RYR2

C13050 → RYR2

C00001 → BST1 → RYR2

C00011 → BST1 → RYR2

C00076 → TPCN2

C13051 → TPCN2

RAB8A

RAP1A

RHOA
RAC1

AMY2A
AMY2B

PRSS1

CTRB1

CELA3A

CPA1

CTRL

CPB1

PNLIP

PNLIPRP1

PNLIPRP2

CEL

PLA2G2D

C00698 → CLCA1

ATP2A1 → CLCA1

Carbohydrate digestion and absorption	Protein digestion and absorption
Fat digestion and absorption	Vitamin digestion and absorption

Pancreatic secretion
MPI-114



Tight junction

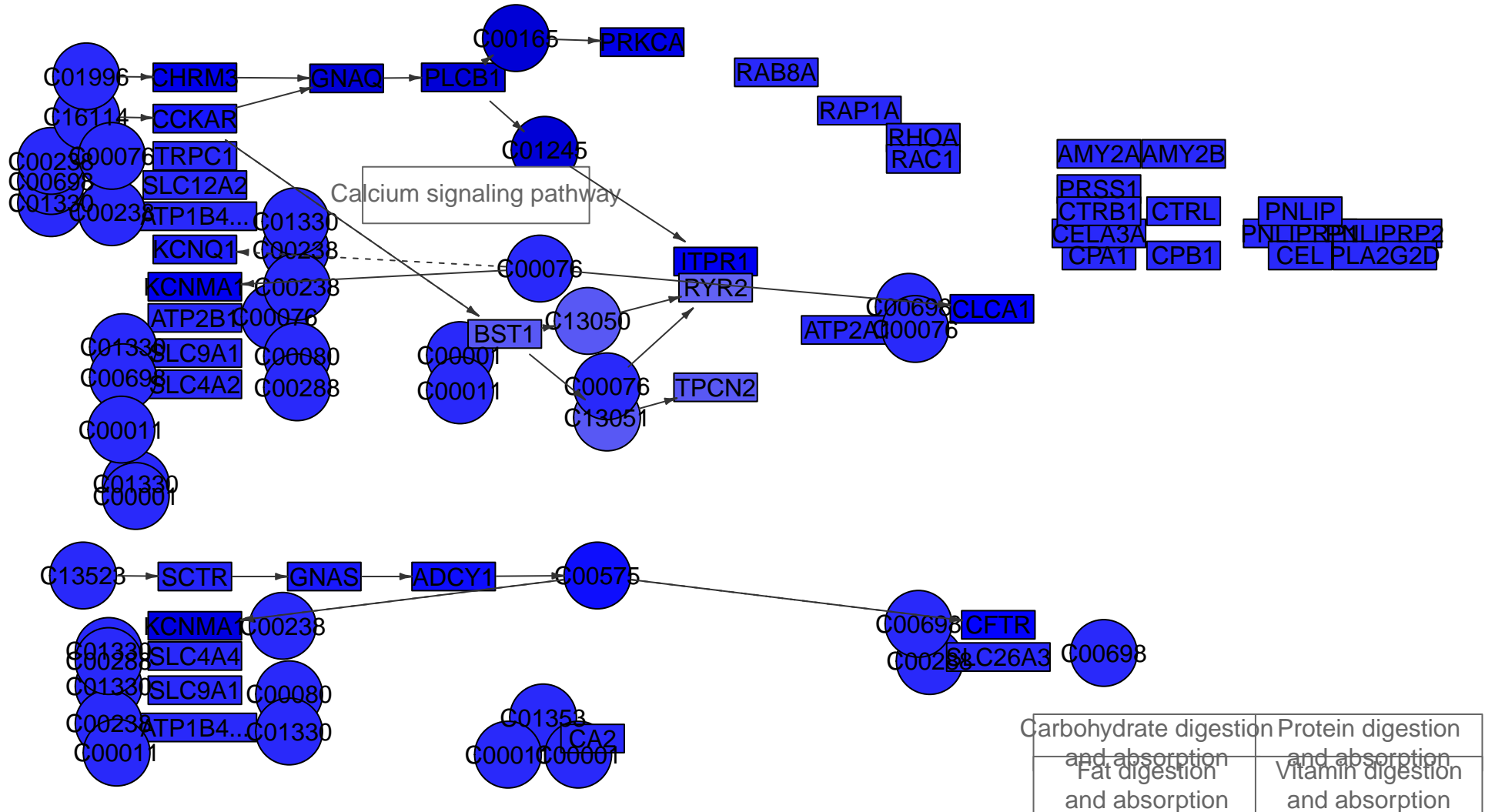

Pancreatic secretion
MPI-123

Tight junction

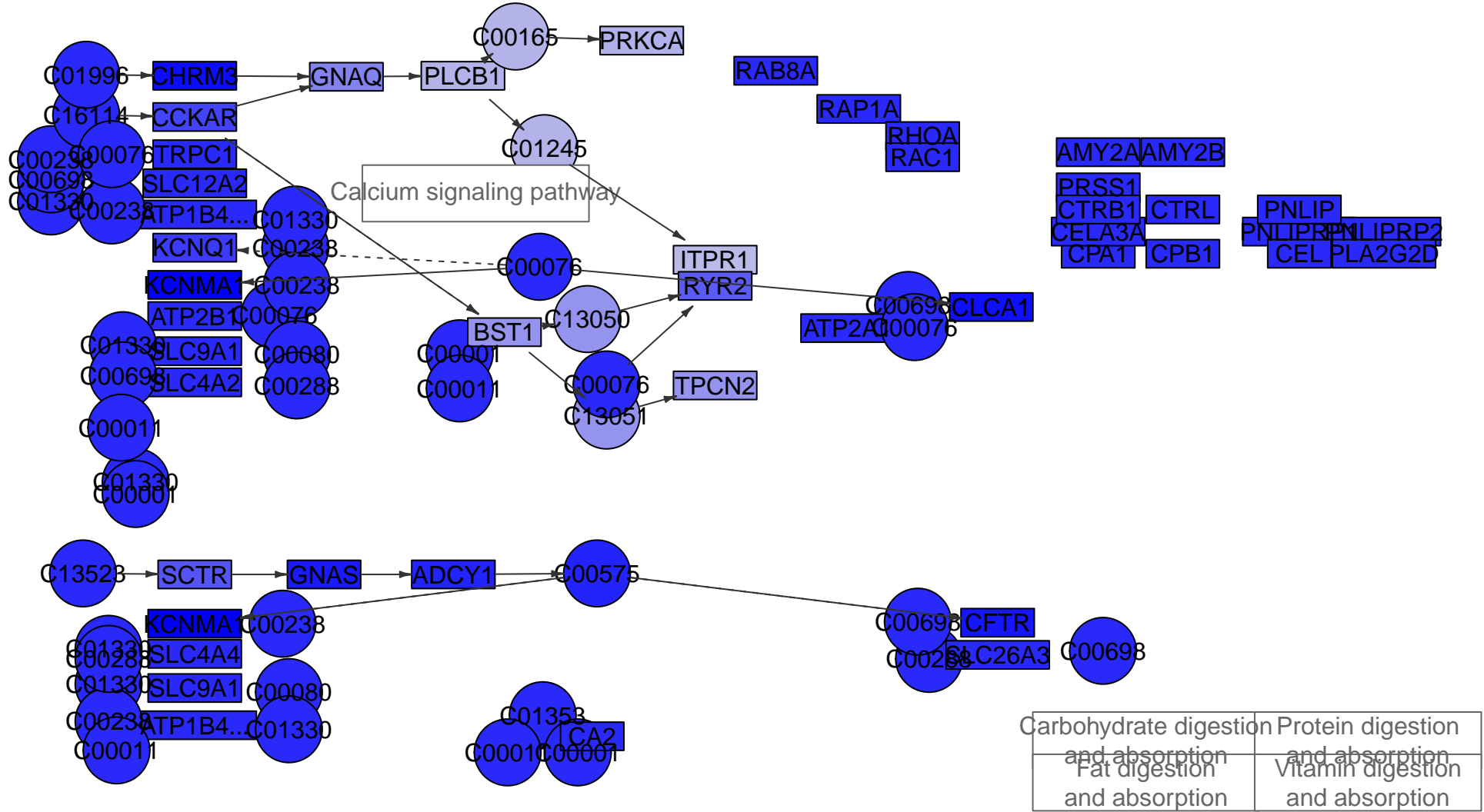

Pancreatic secretion
MPI-138



Tight junction

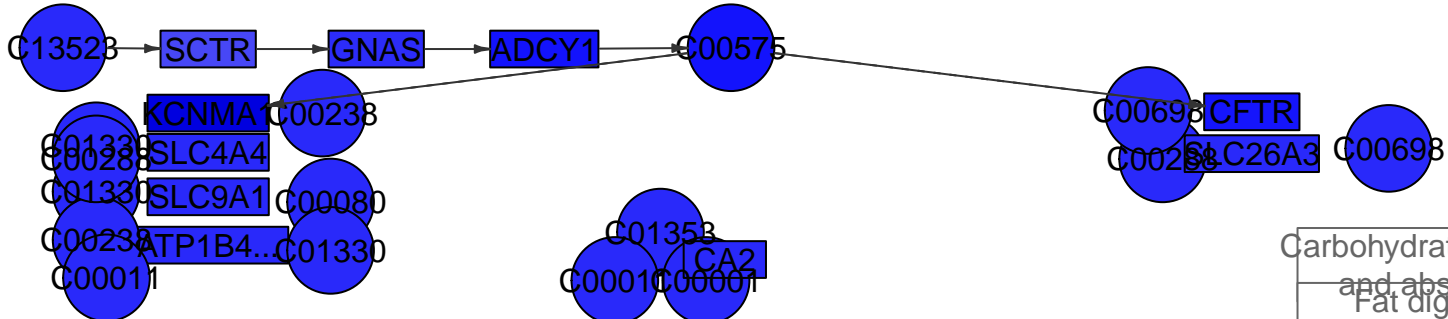
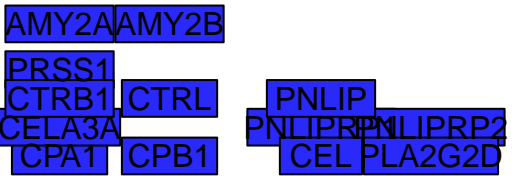
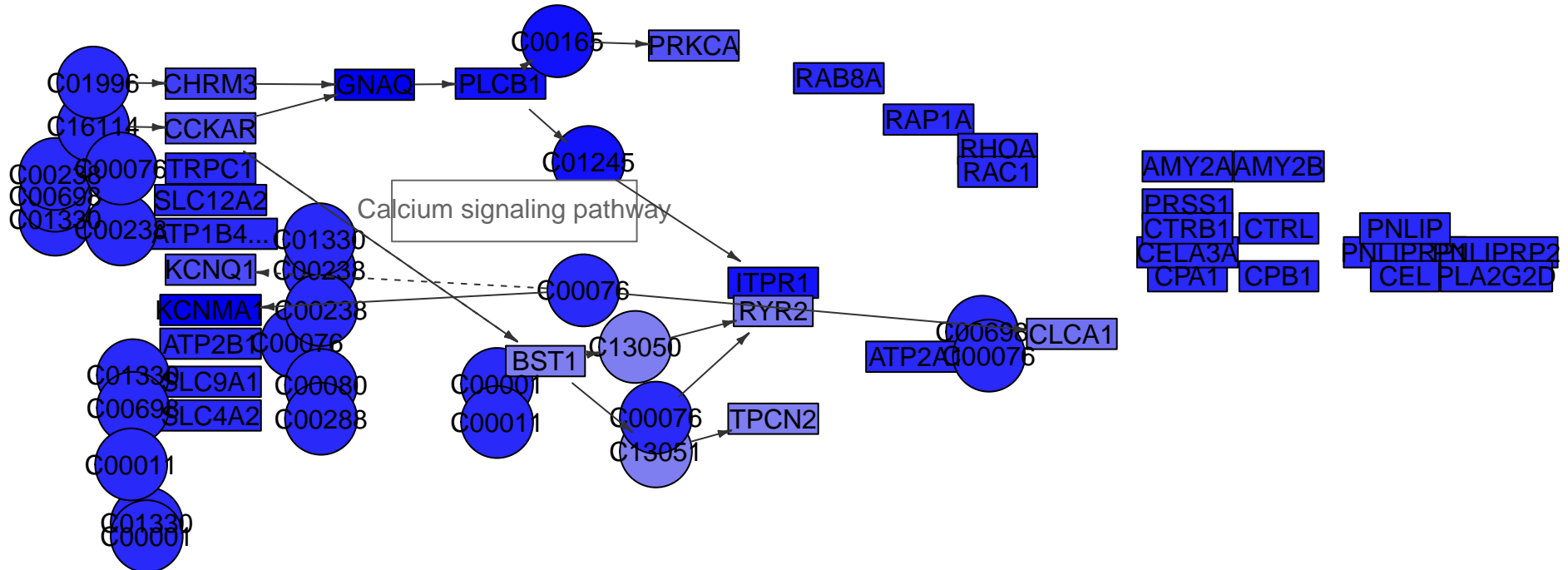

Carbohydrate digestion and absorption	Protein digestion and absorption
Fat digestion and absorption	Vitamin digestion and absorption

Pancreatic secretion
MPI-139

Tight junction

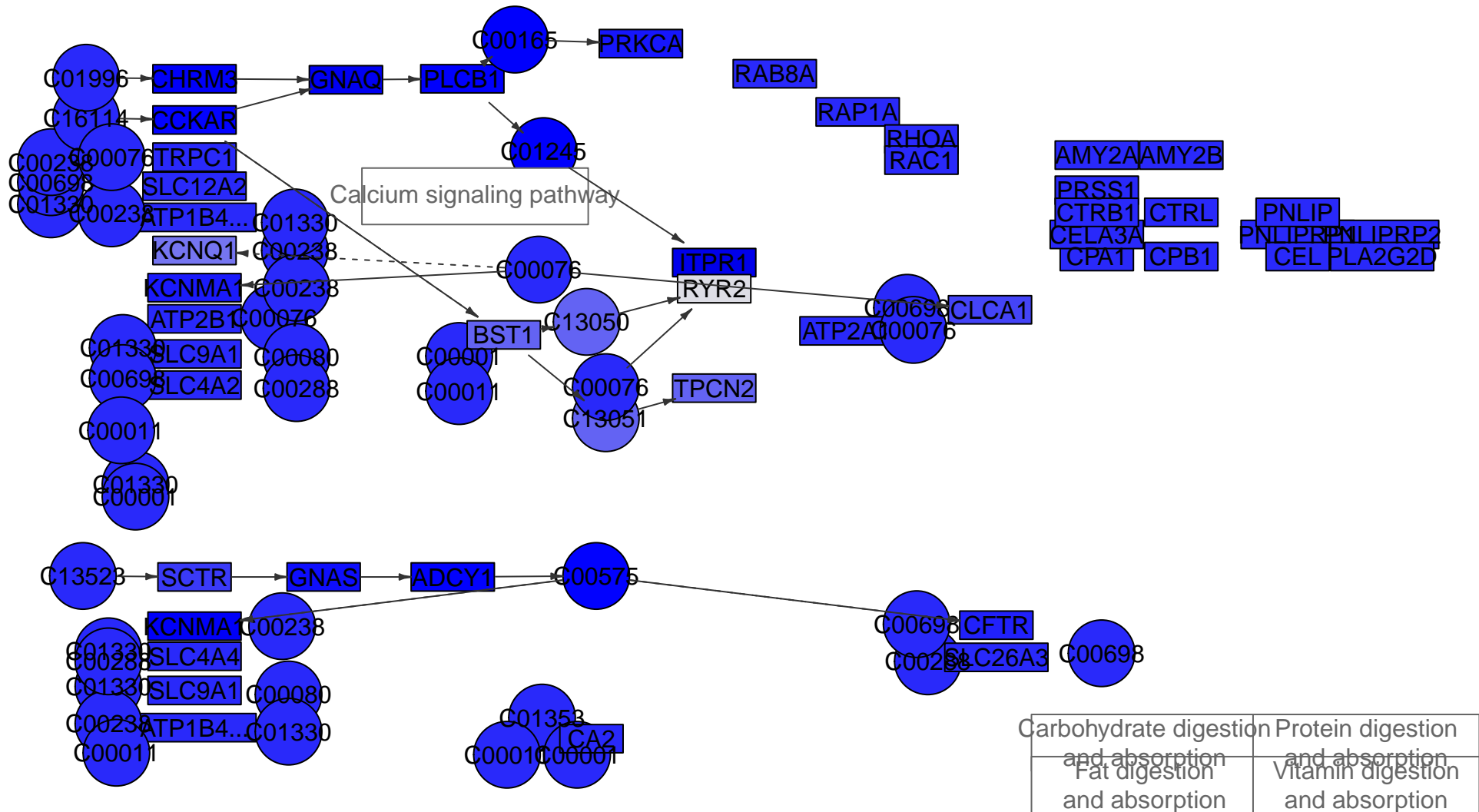

Pancreatic secretion
MPI-147

Tight junction

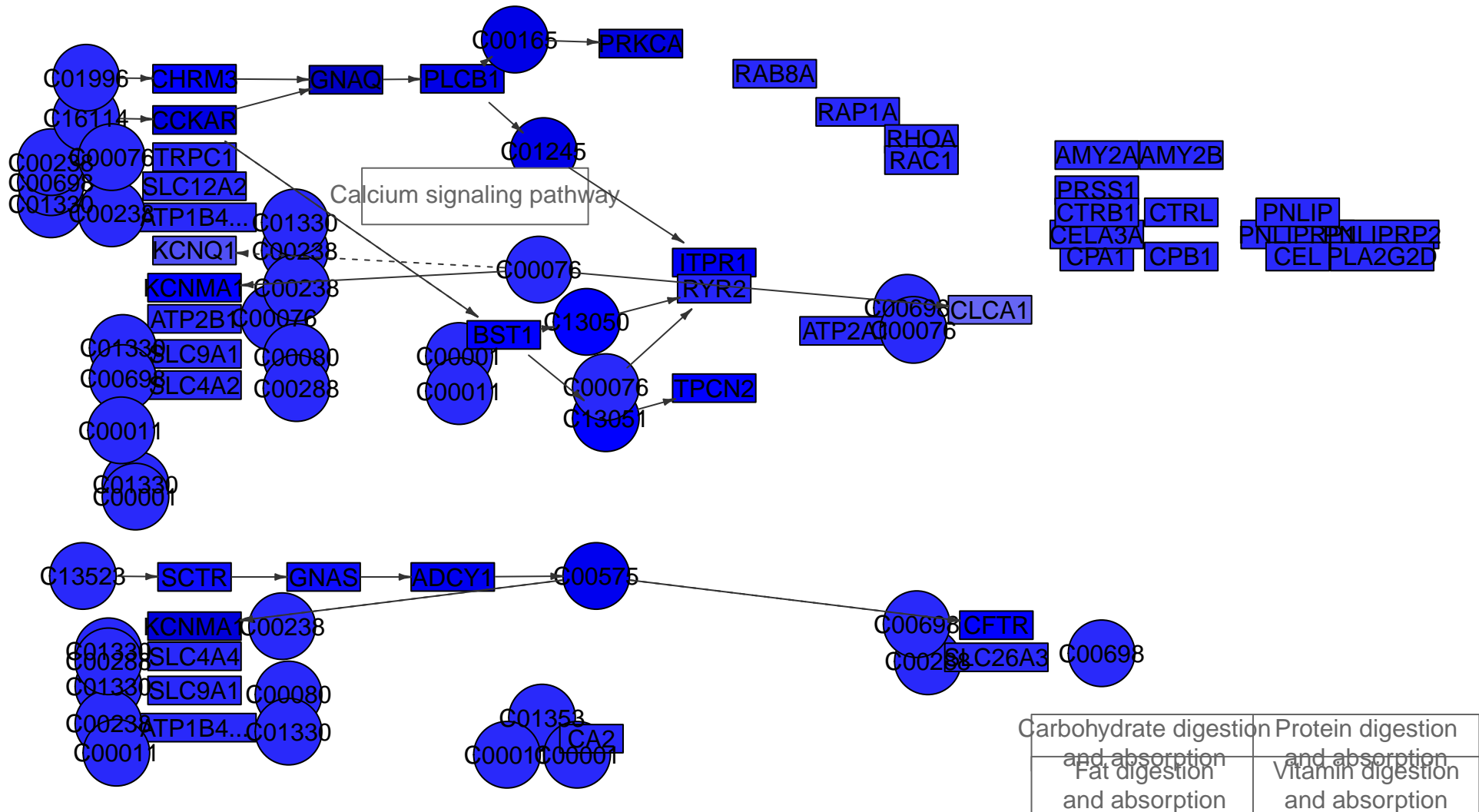

Pancreatic secretion
MPI-171

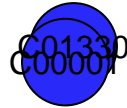

Tight junction

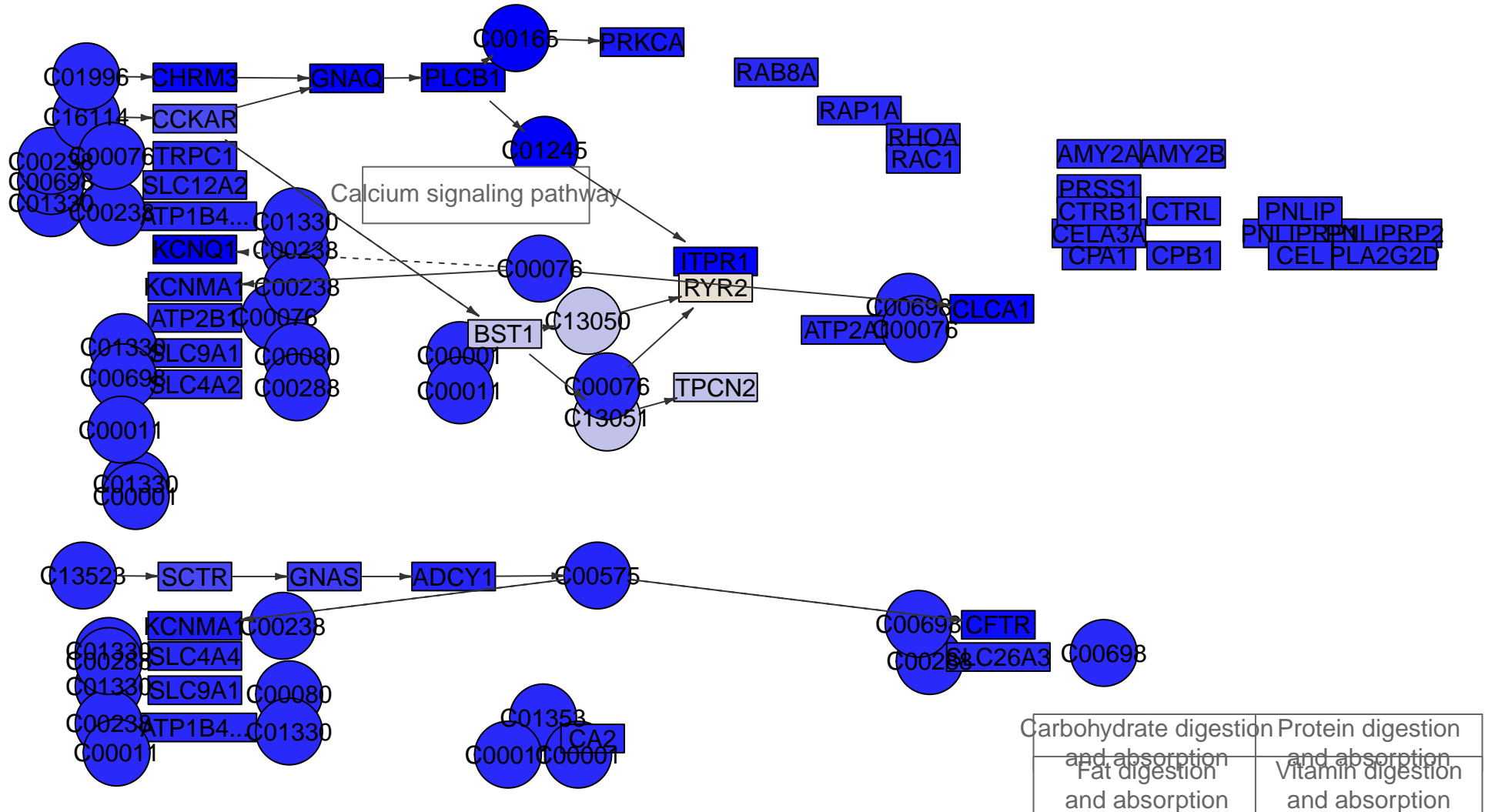

Pancreatic secretion
MPI-172



Tight junction

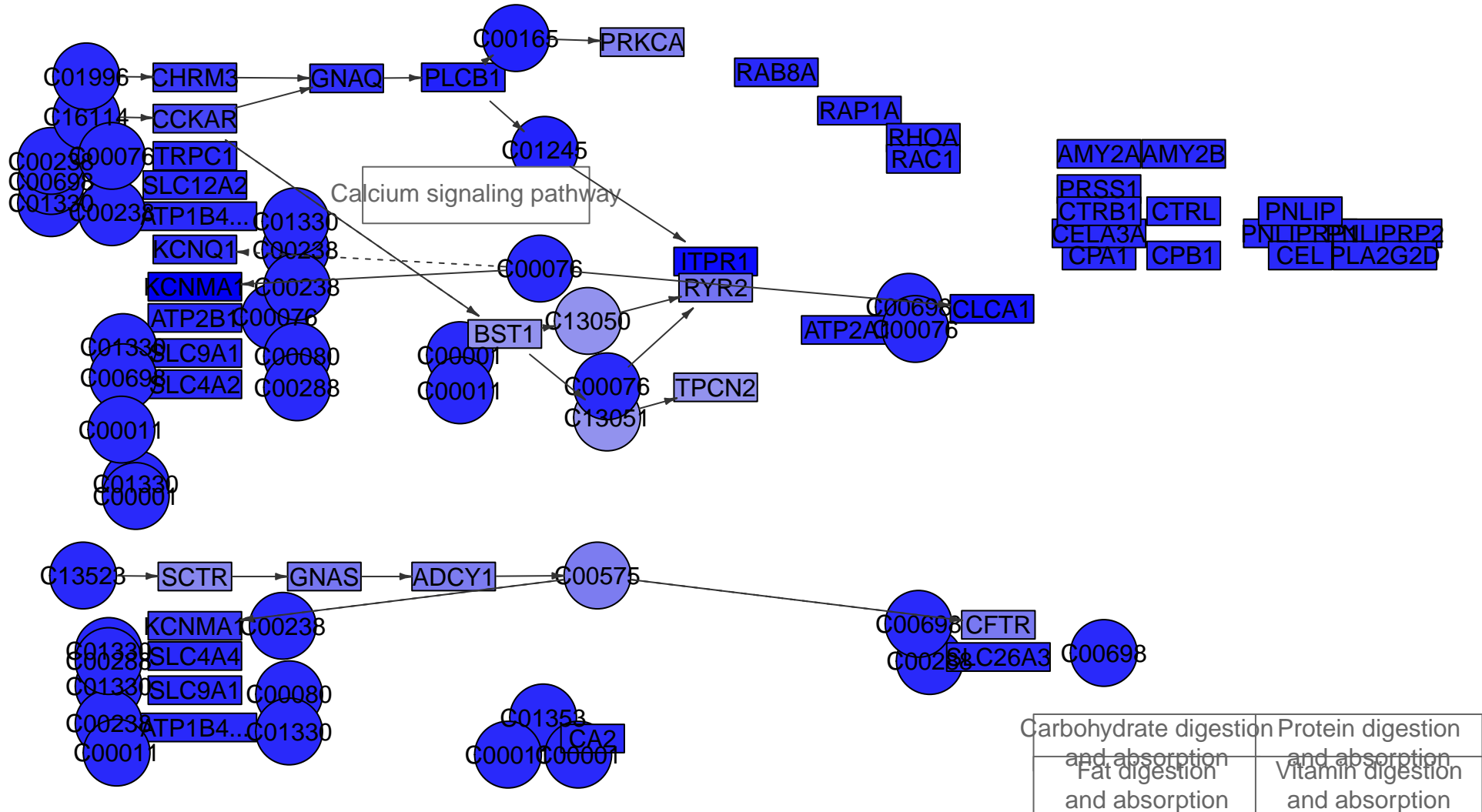

Pancreatic secretion
MPI-007



Tight junction

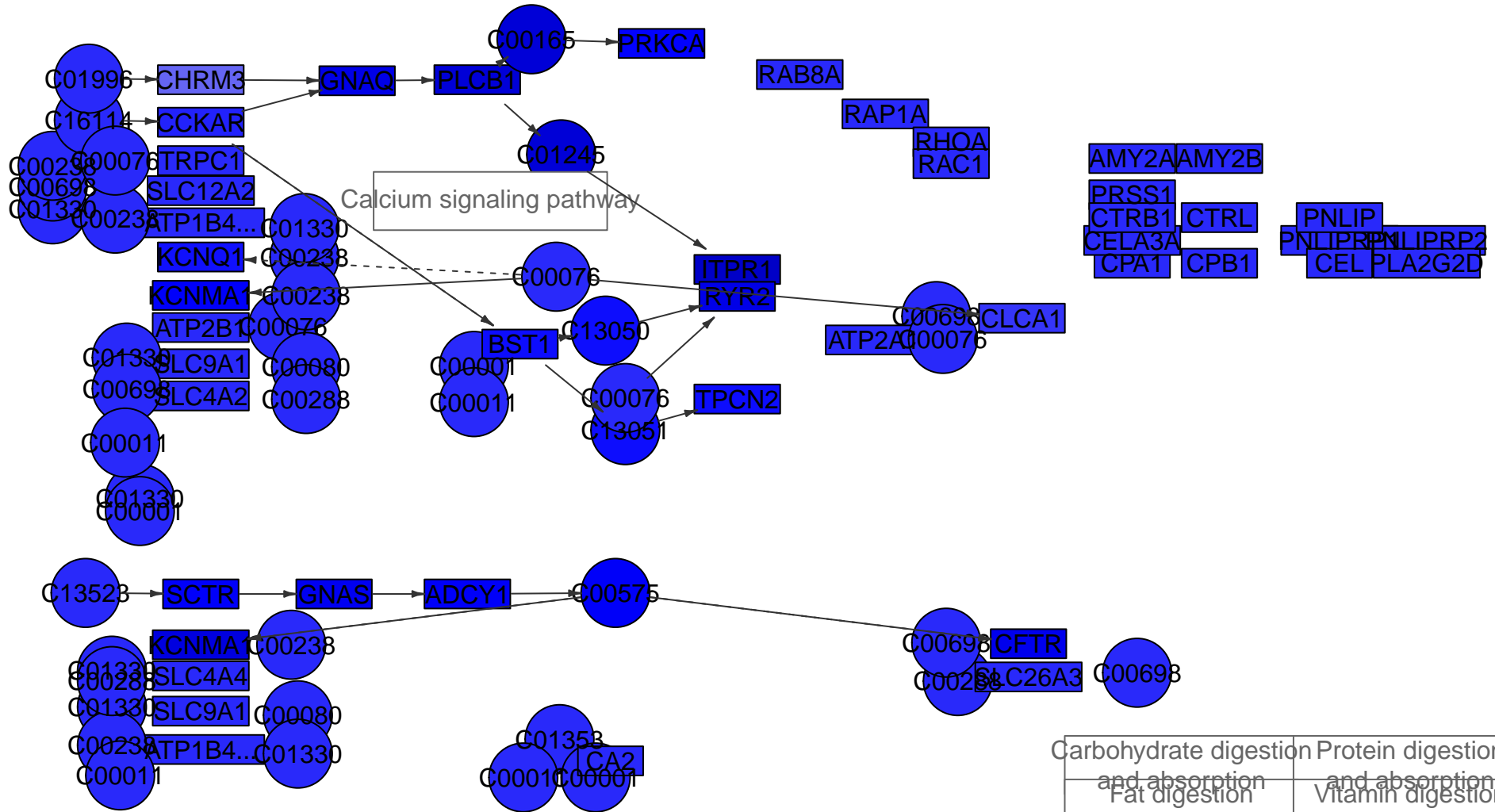

Carbohydrate digestion and absorption	Protein digestion and absorption
Fat digestion and absorption	Vitamin digestion and absorption

Pancreatic secretion
MPI-024



Tight junction

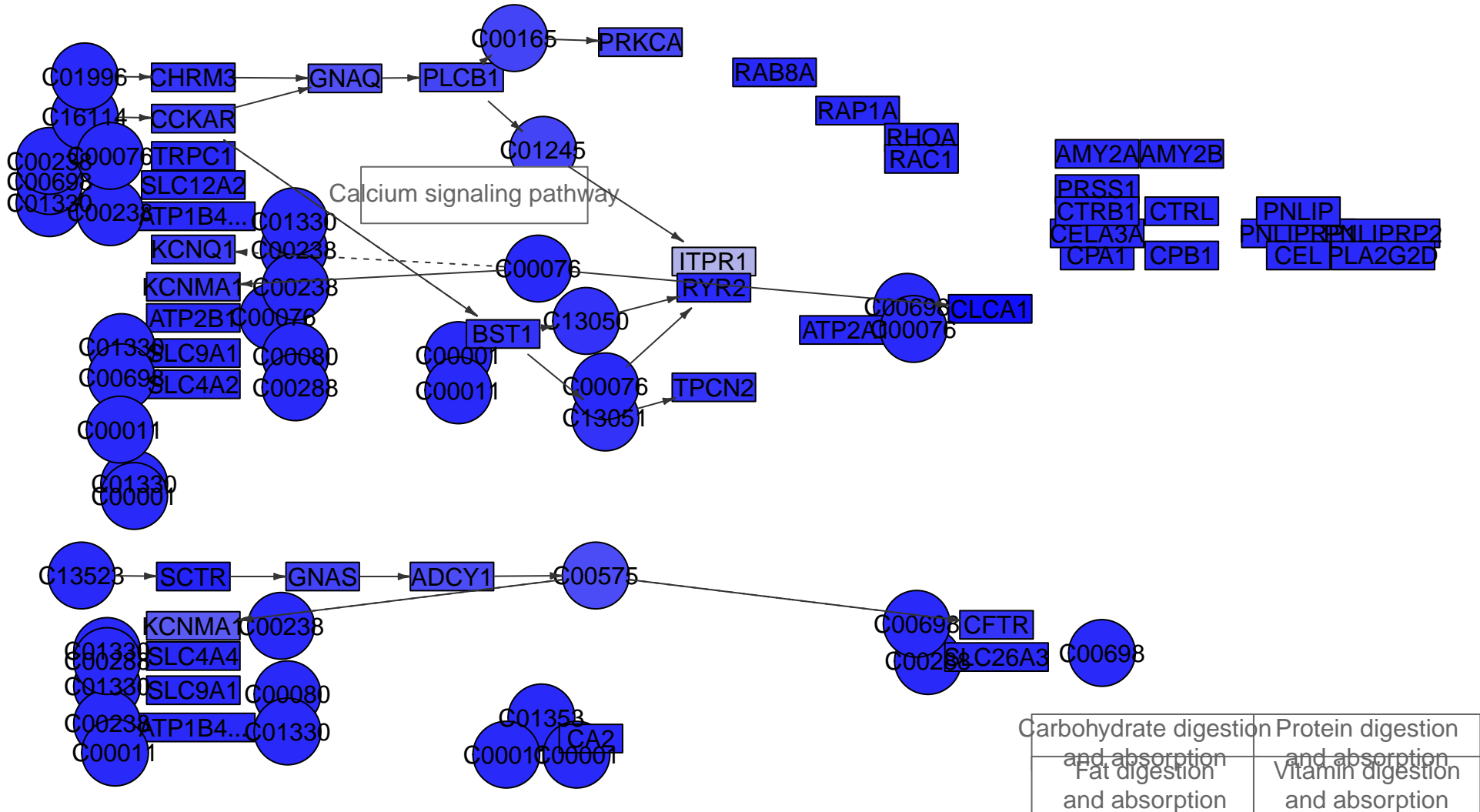

Pancreatic secretion
MPI-026



Tight junction

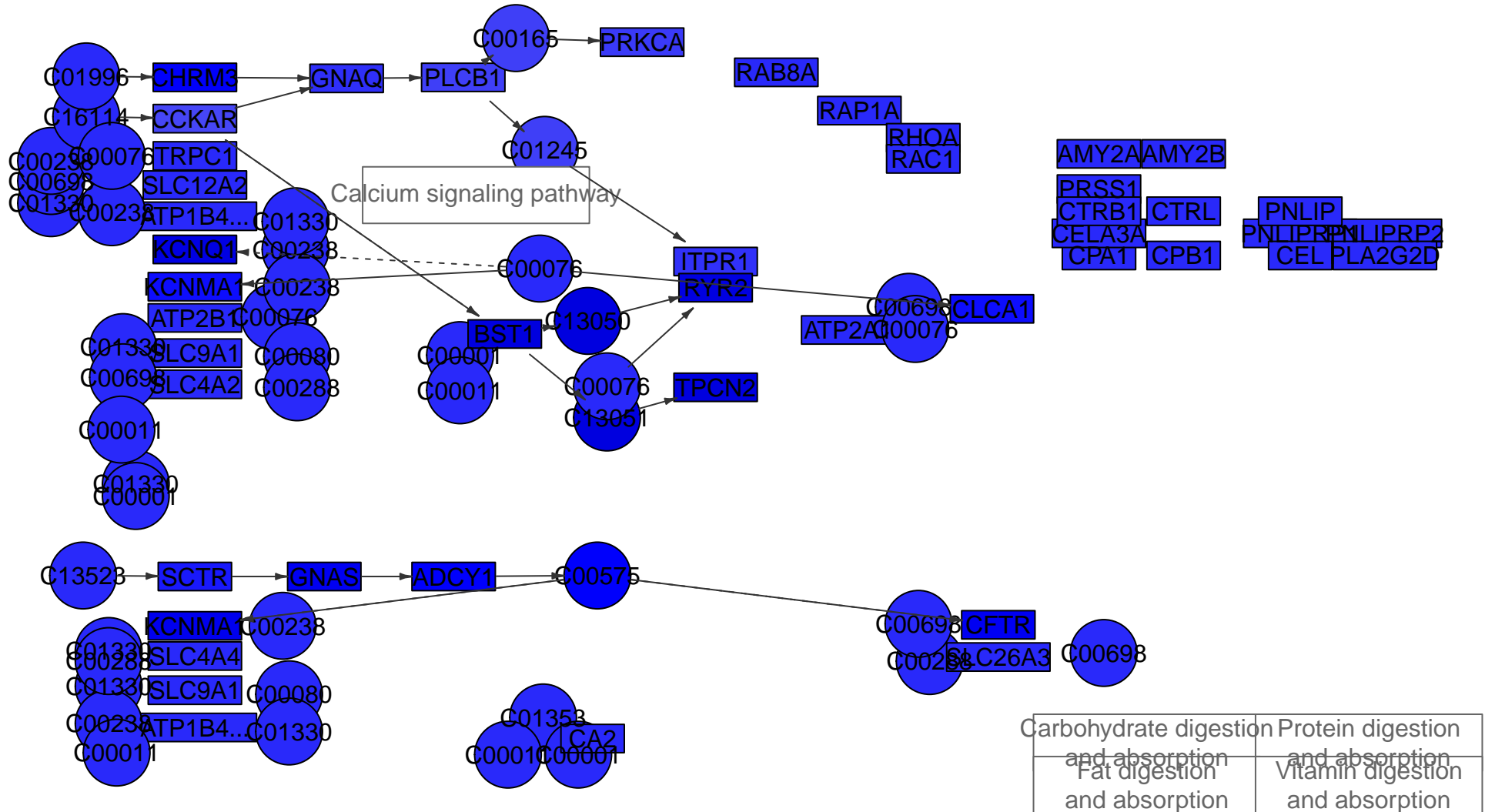

Pancreatic secretion
MPI-036



Tight junction

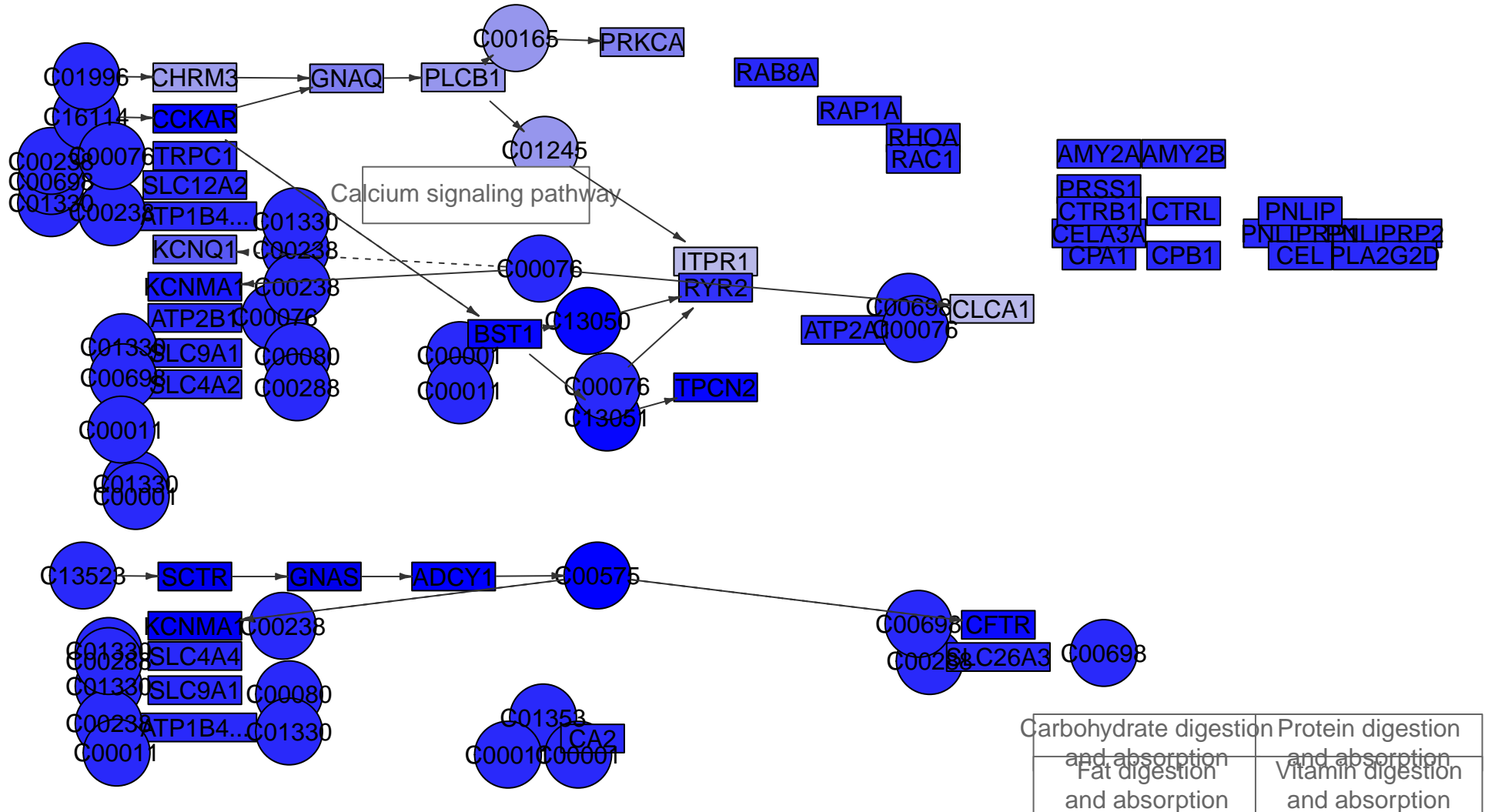

Pancreatic secretion
MPI-037



Tight junction

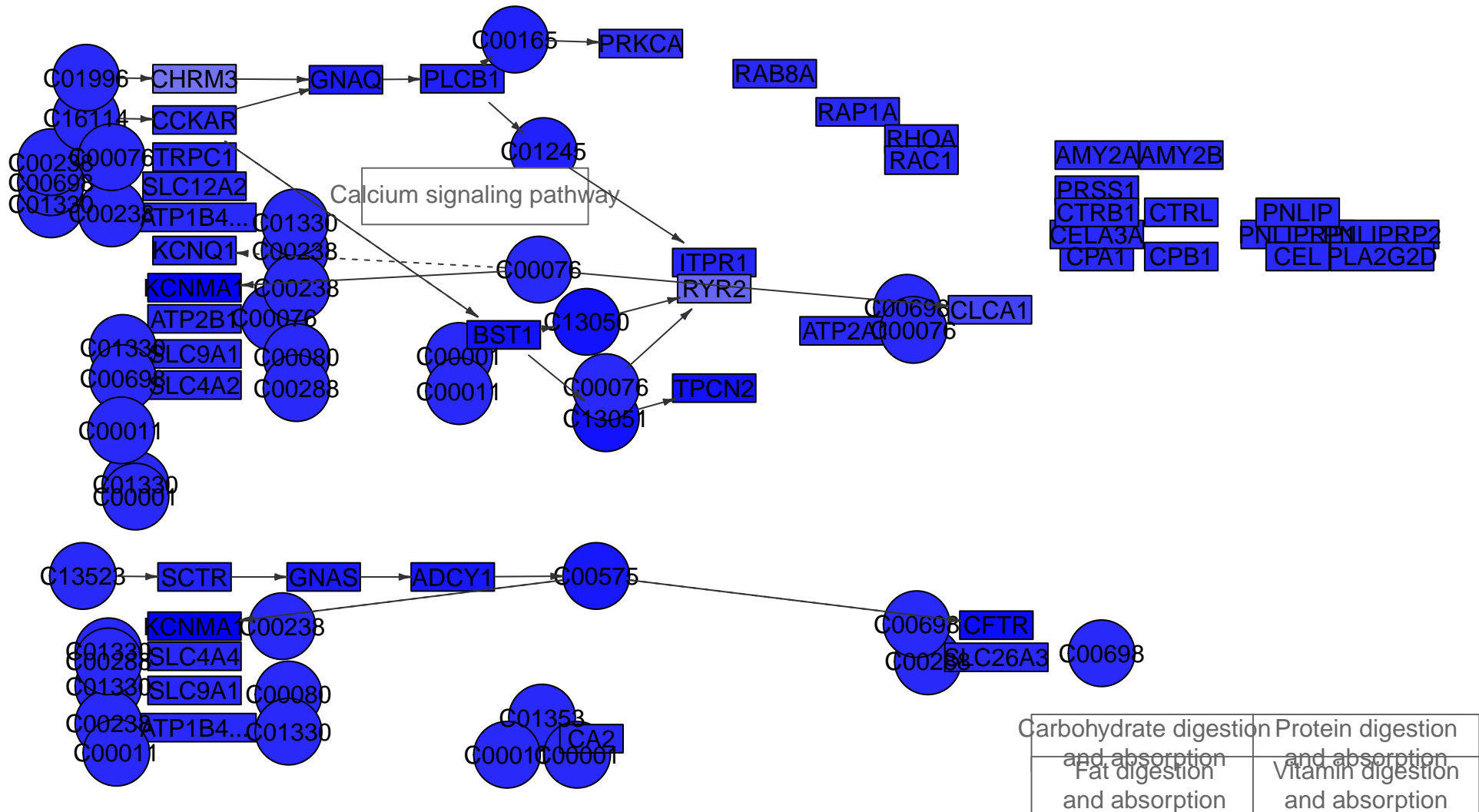

Pancreatic secretion
MPI-038

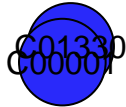

Tight junction

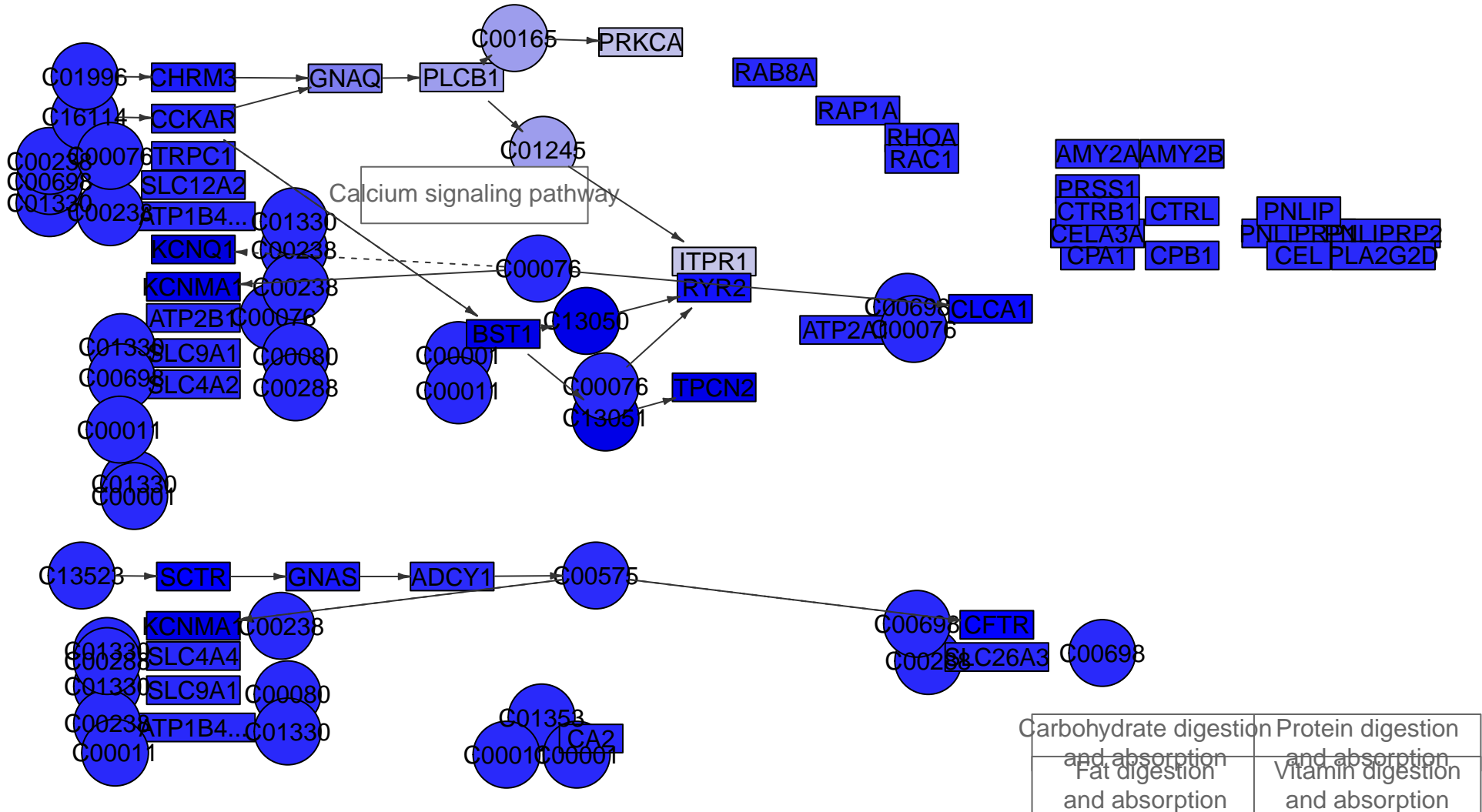

Pancreatic secretion
MPI-041

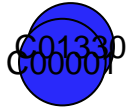

Tight junction

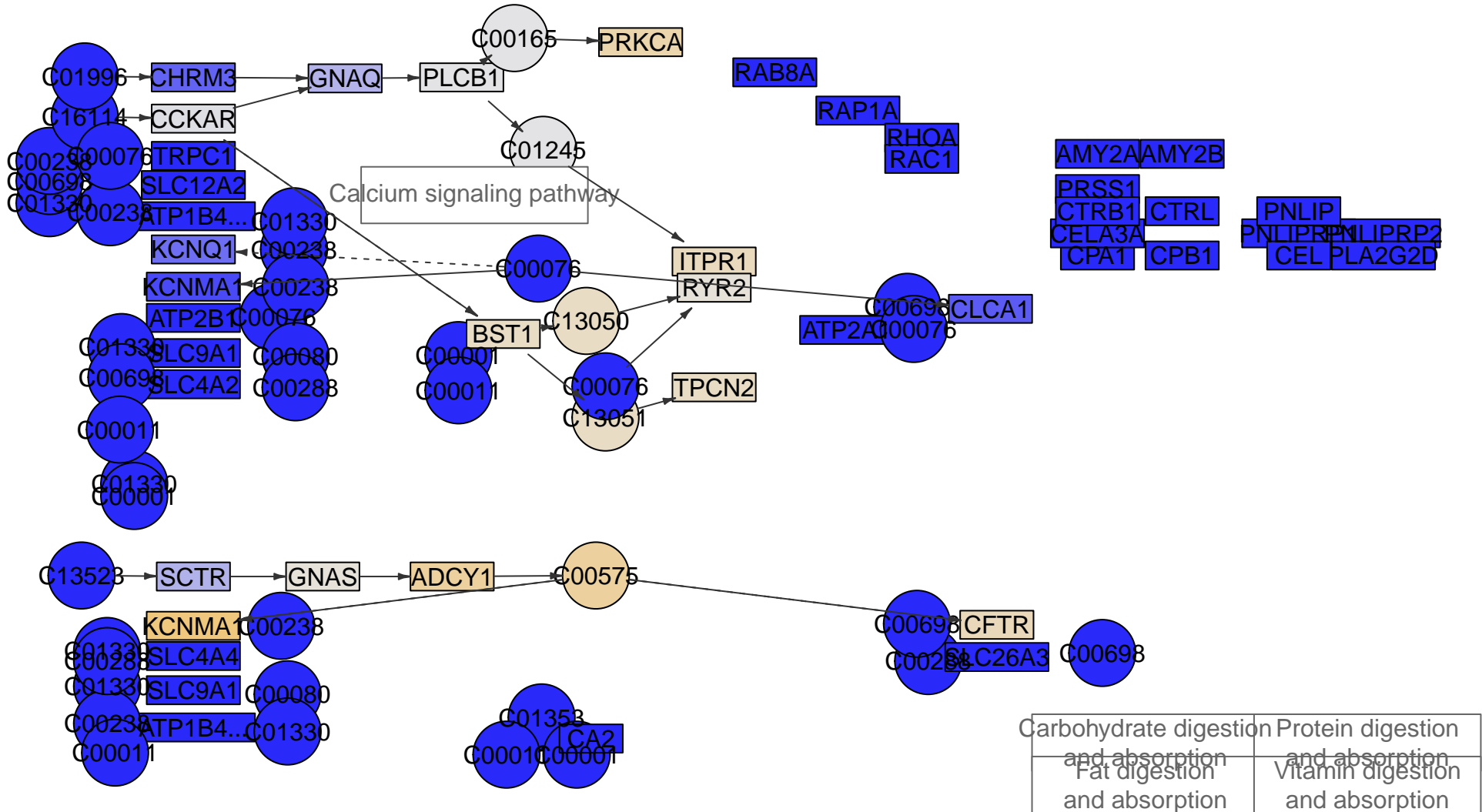

Pancreatic secretion
MPI-046

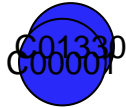

Tight junction

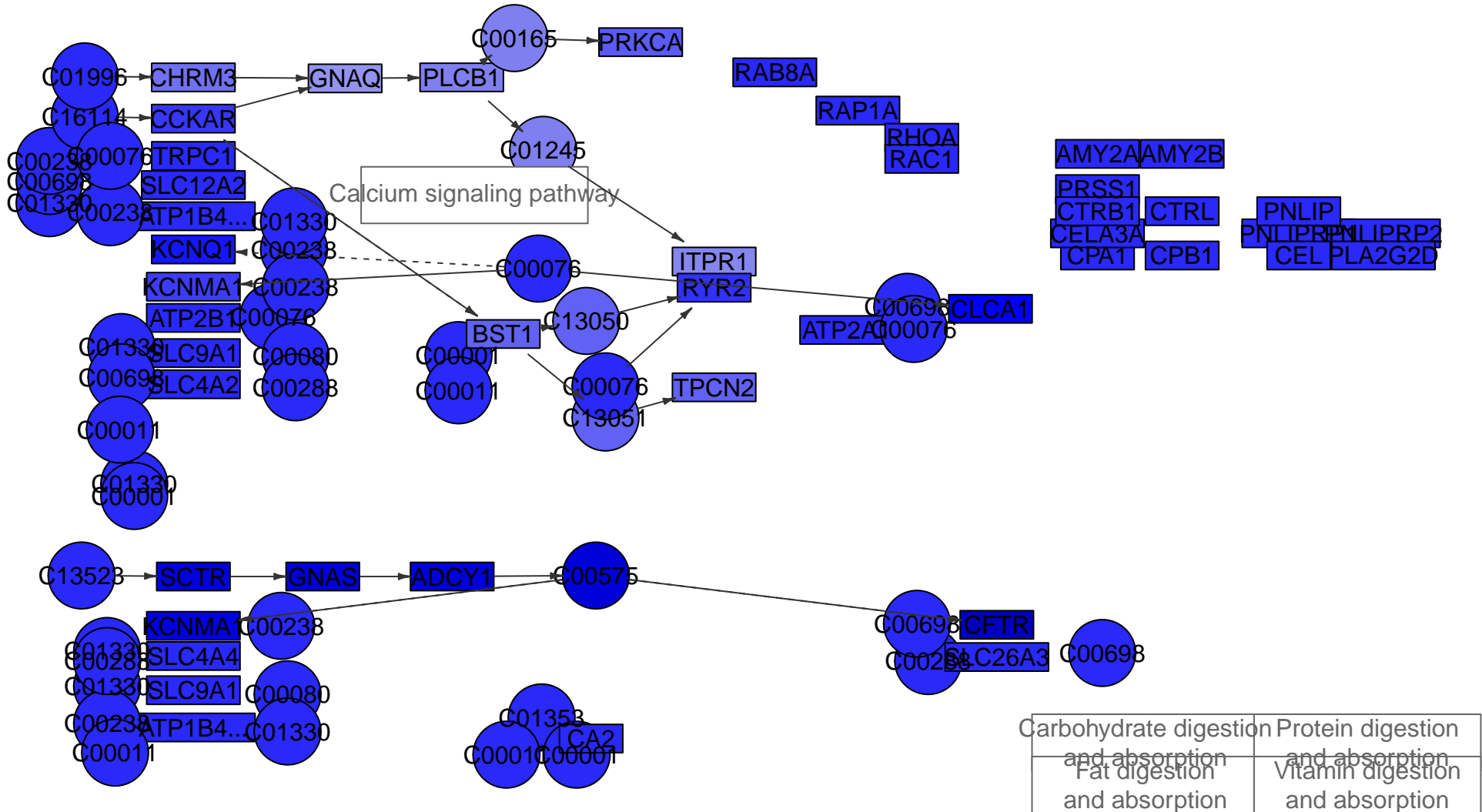

Pancreatic secretion
MPI-050

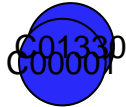

Tight junction

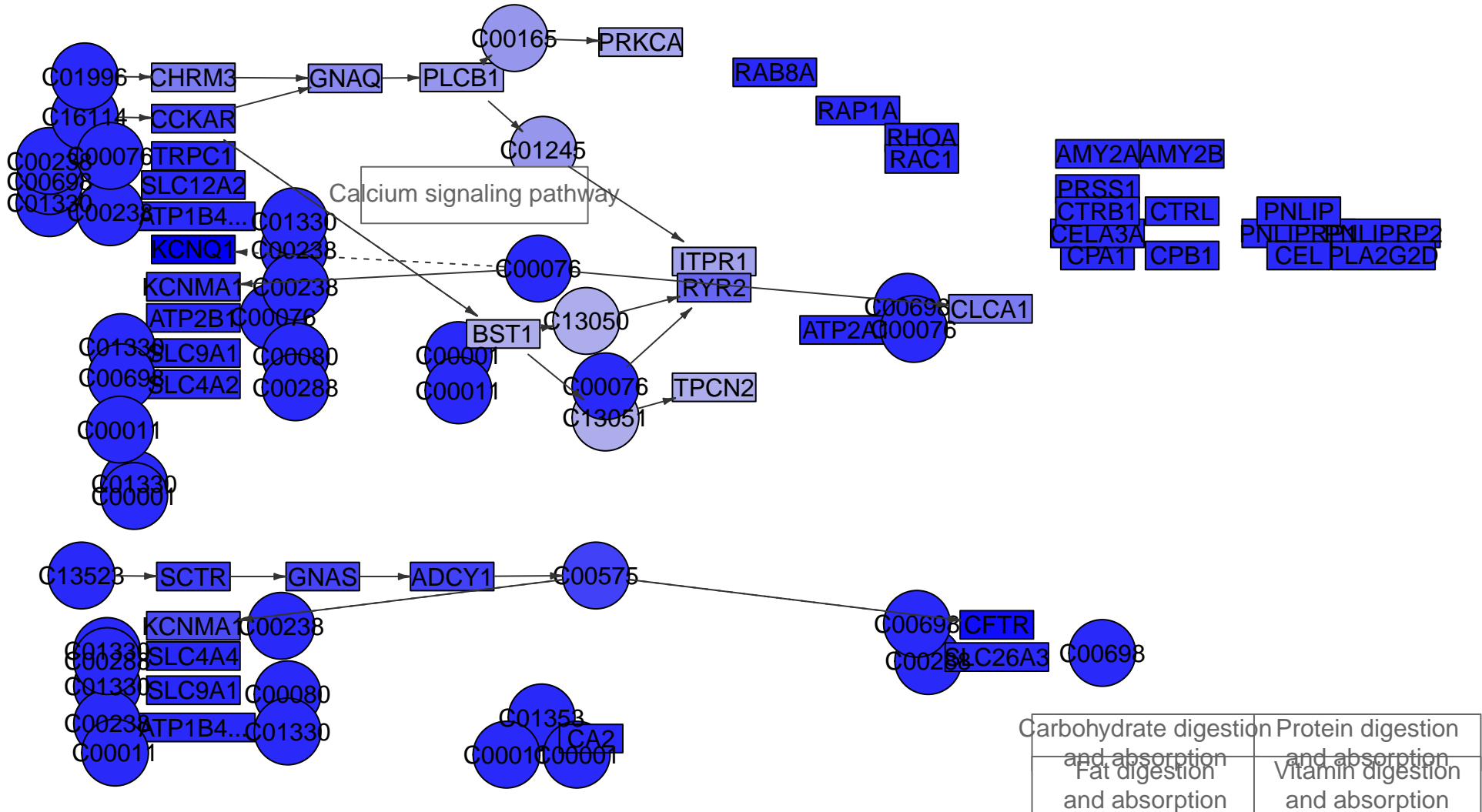

Pancreatic secretion
MPI-051

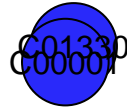

Tight junction

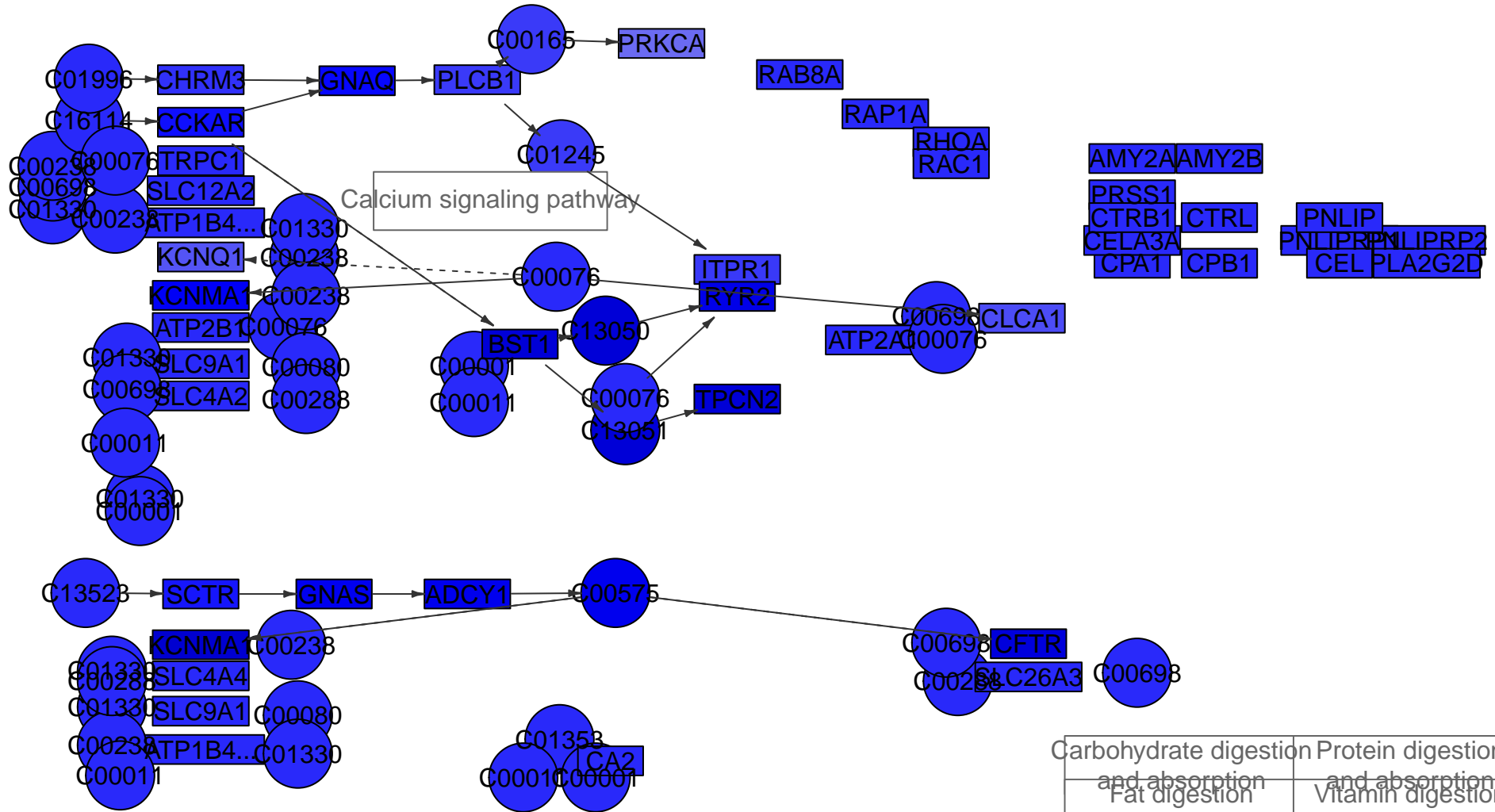

Pancreatic secretion
MPI-051

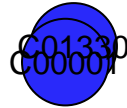

Tight junction

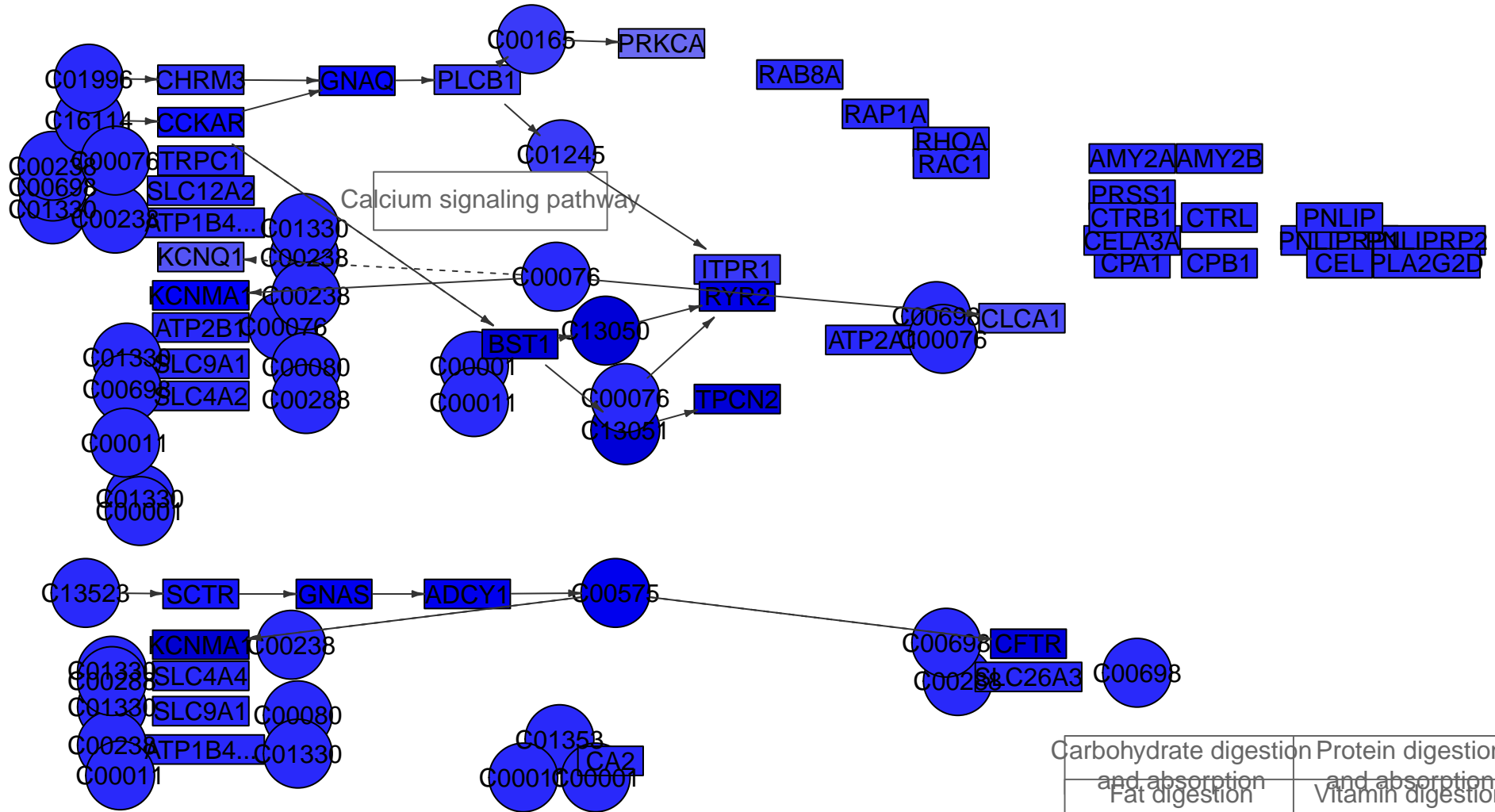

Pancreatic secretion
MPI-054



Tight junction

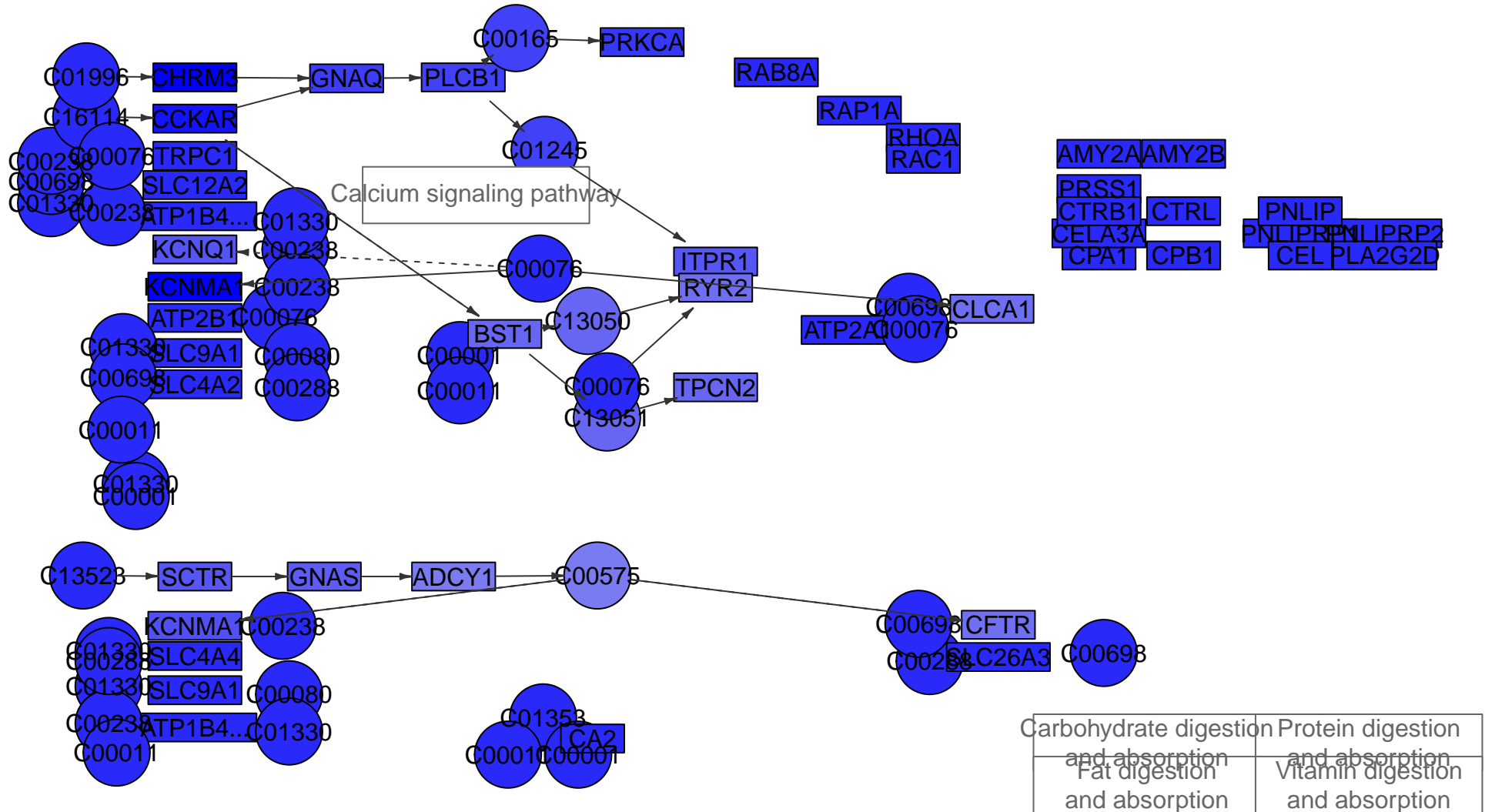

Pancreatic secretion
MPI-060

Tight junction

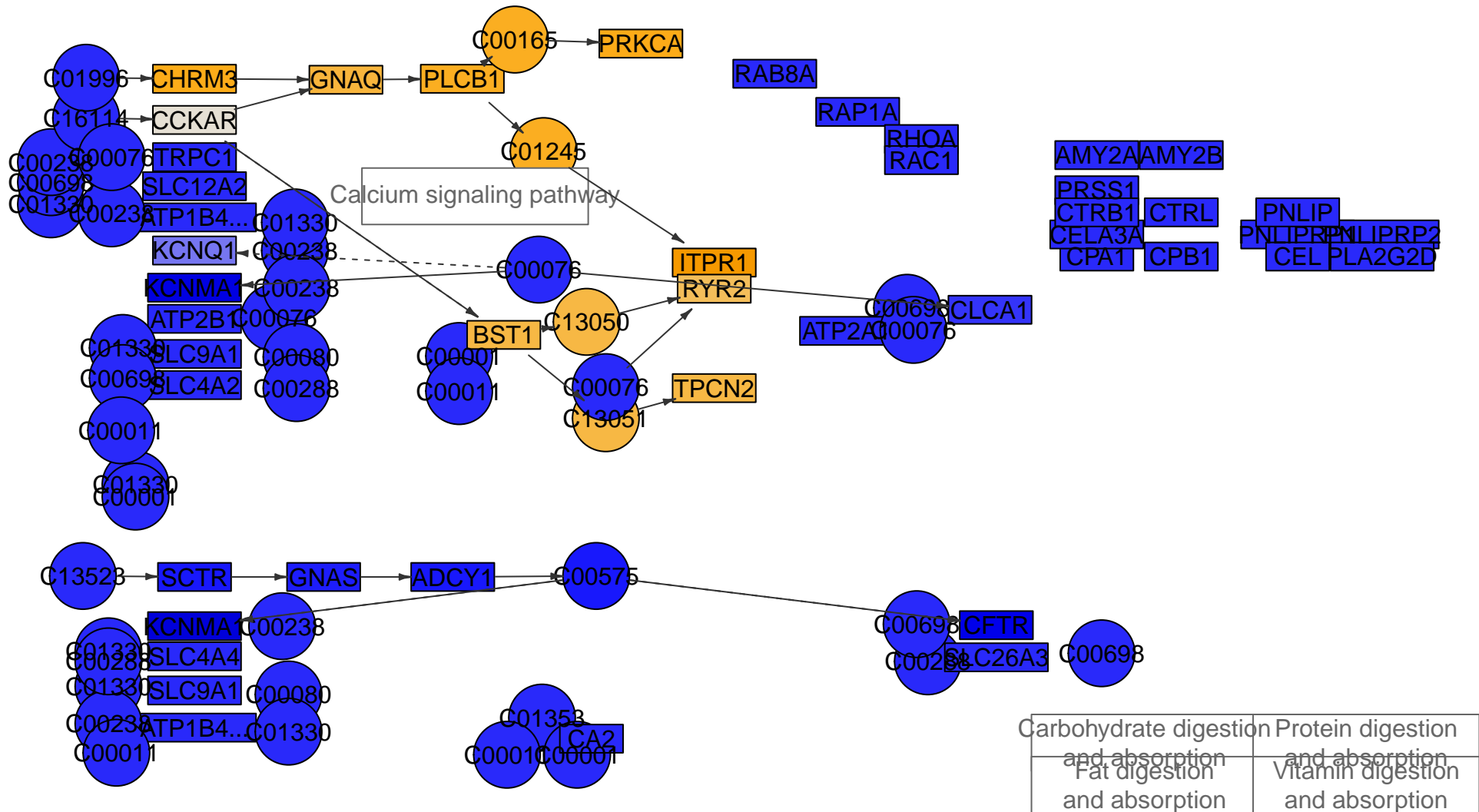

Pancreatic secretion
MPI-061



Tight junction

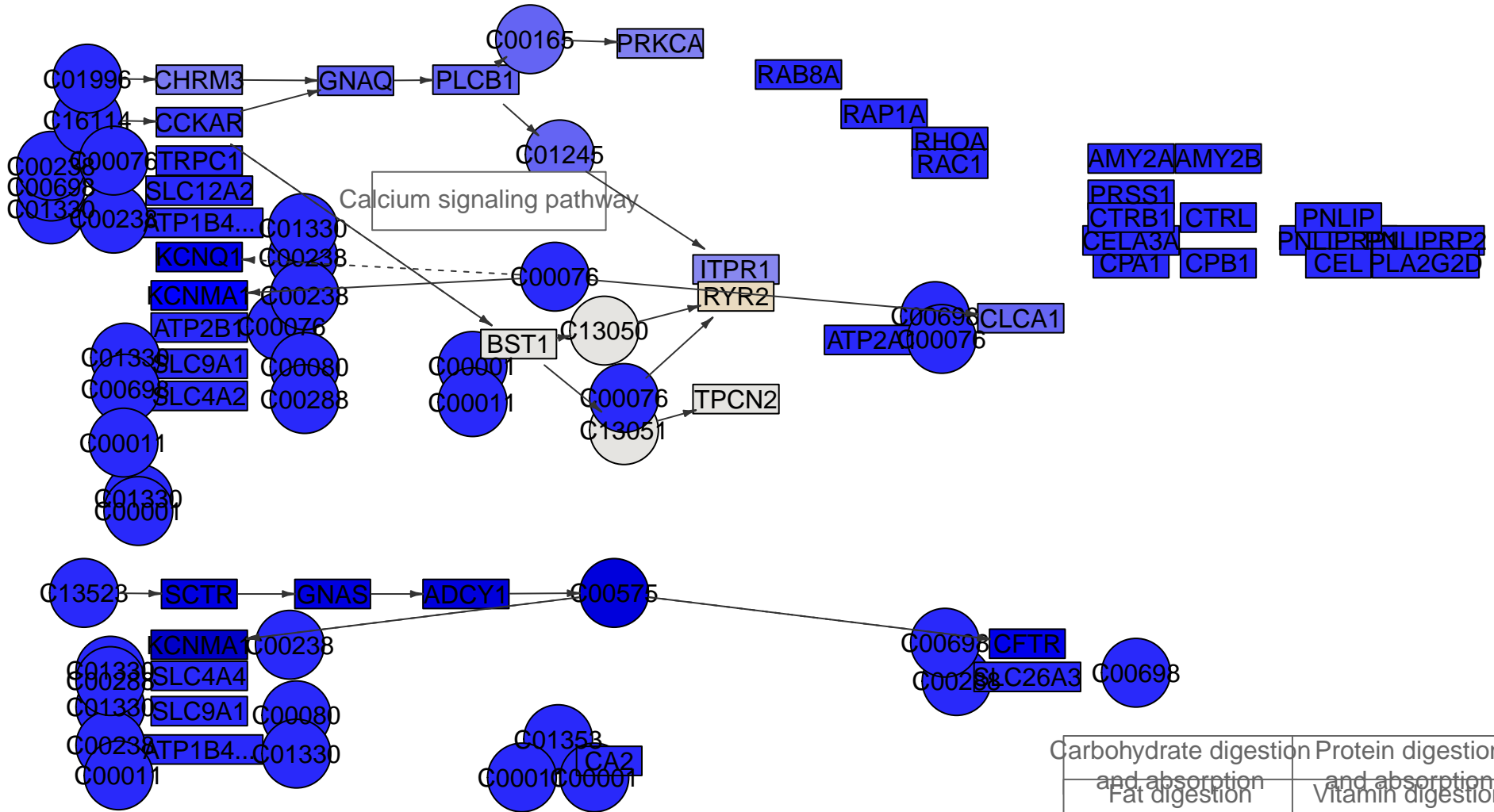

Pancreatic secretion
MPI-064



Tight junction

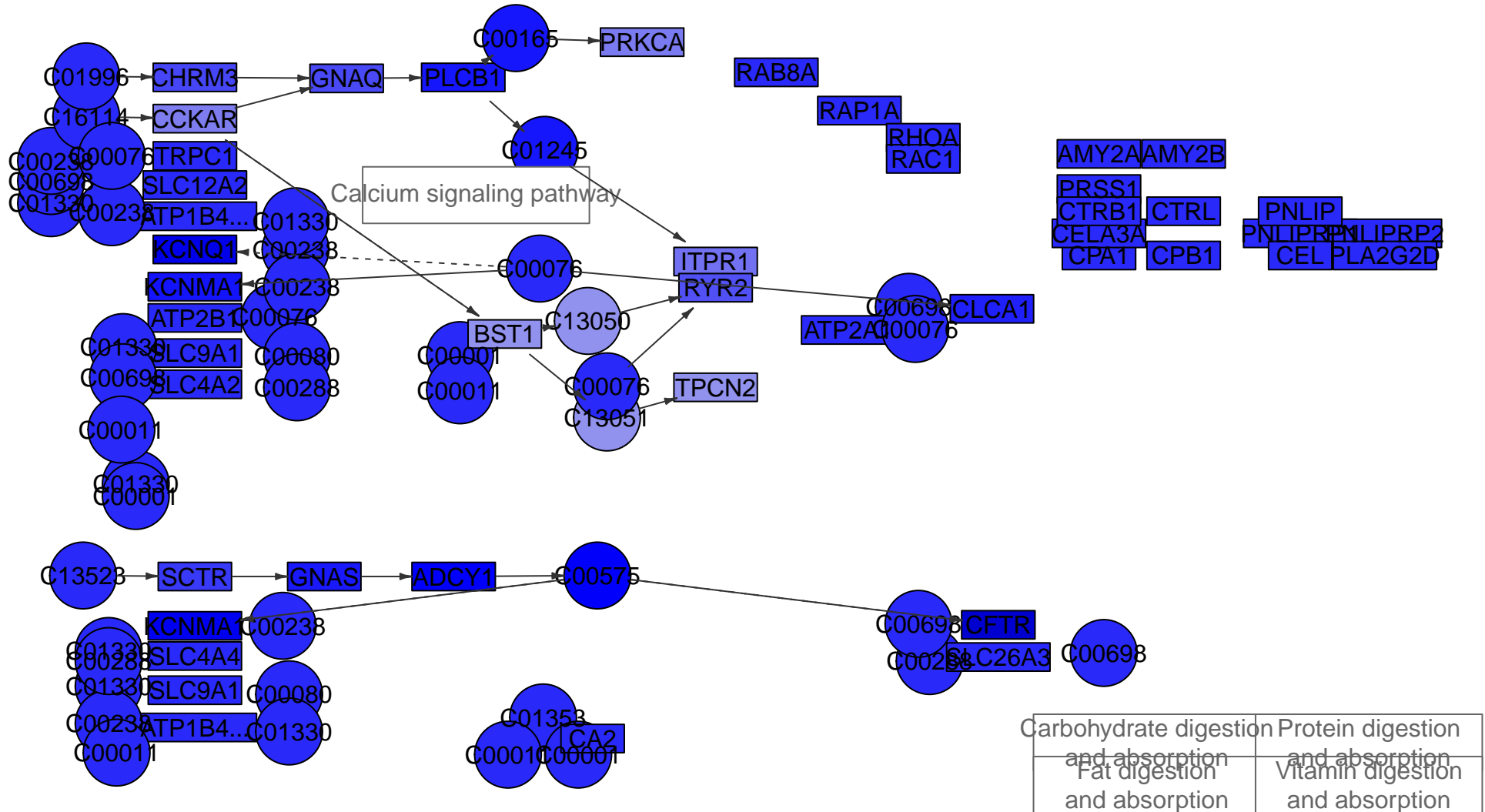

Pancreatic secretion
MPI-070



Tight junction

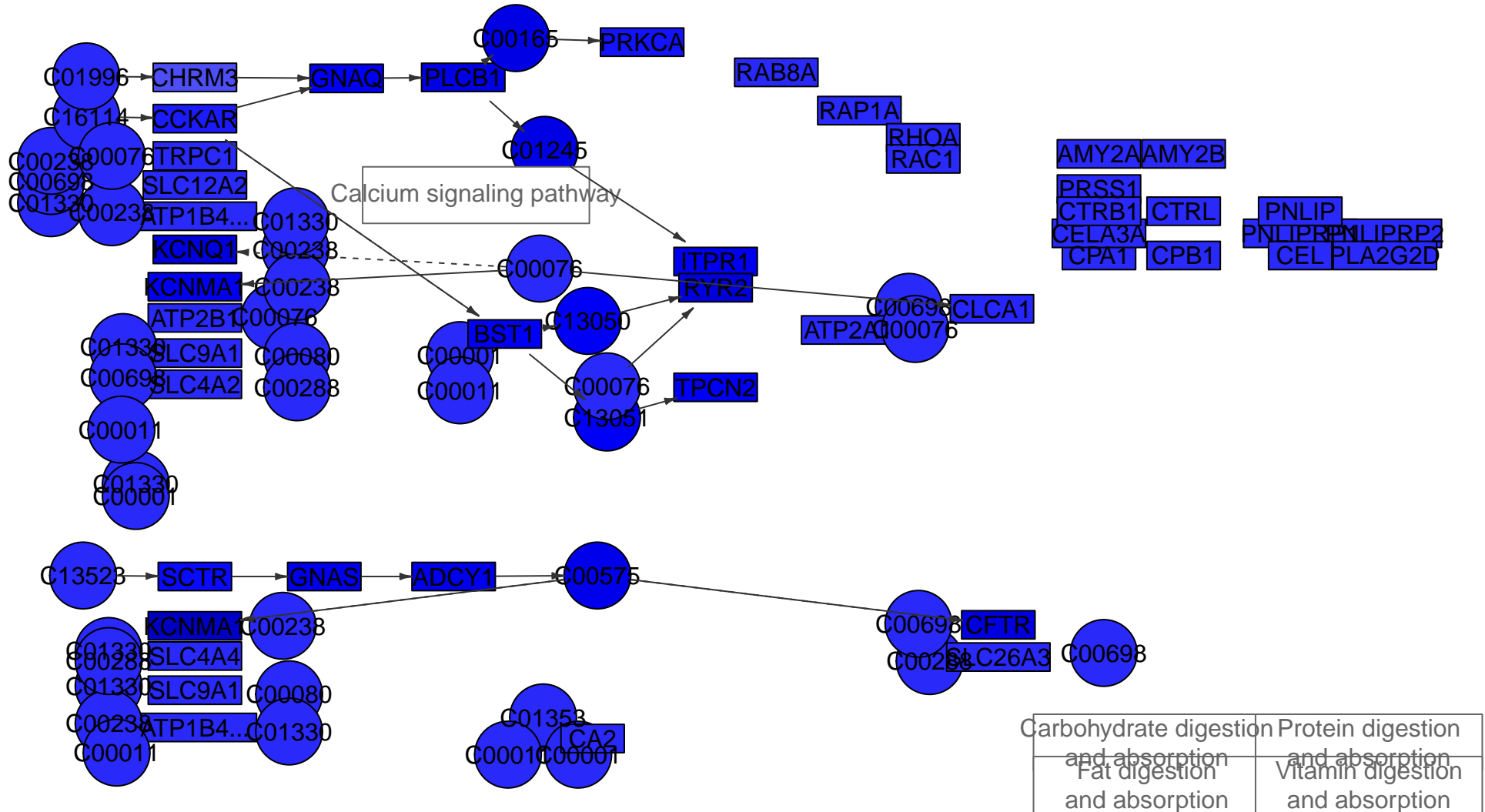

Pancreatic secretion
MPI-072



Tight junction

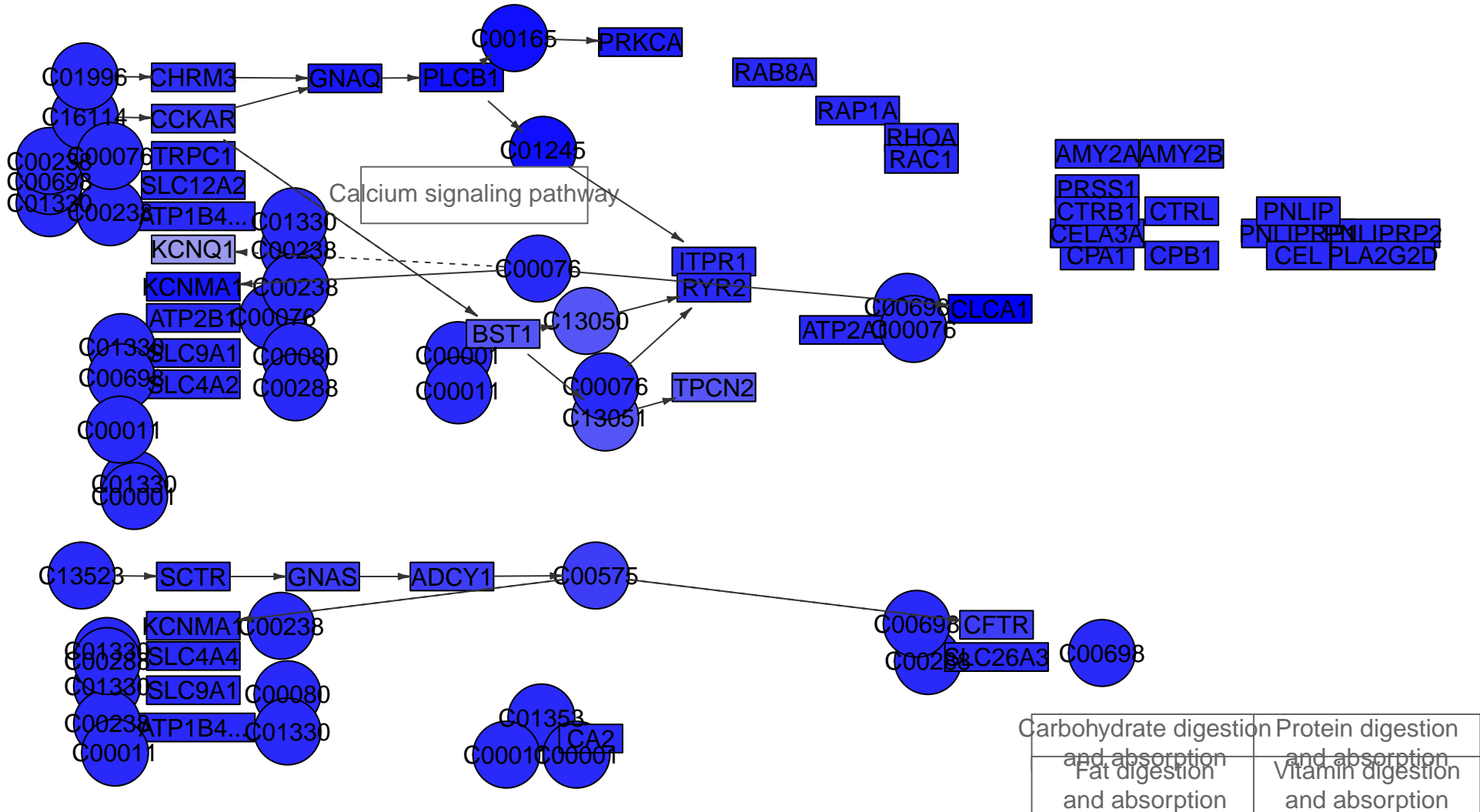

Pancreatic secretion
MPI-094



Tight junction

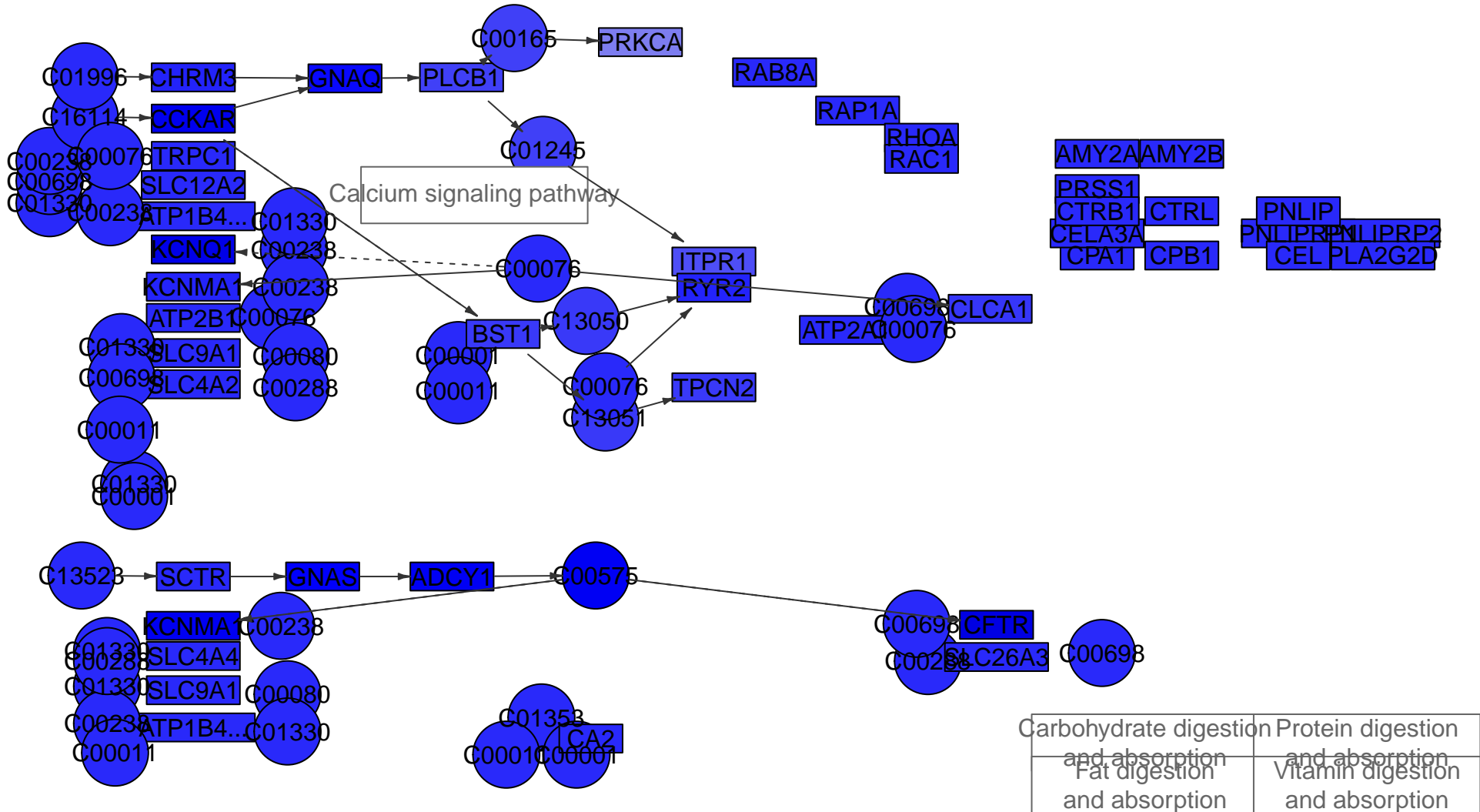

Pancreatic secretion
MPI-099



Tight junction

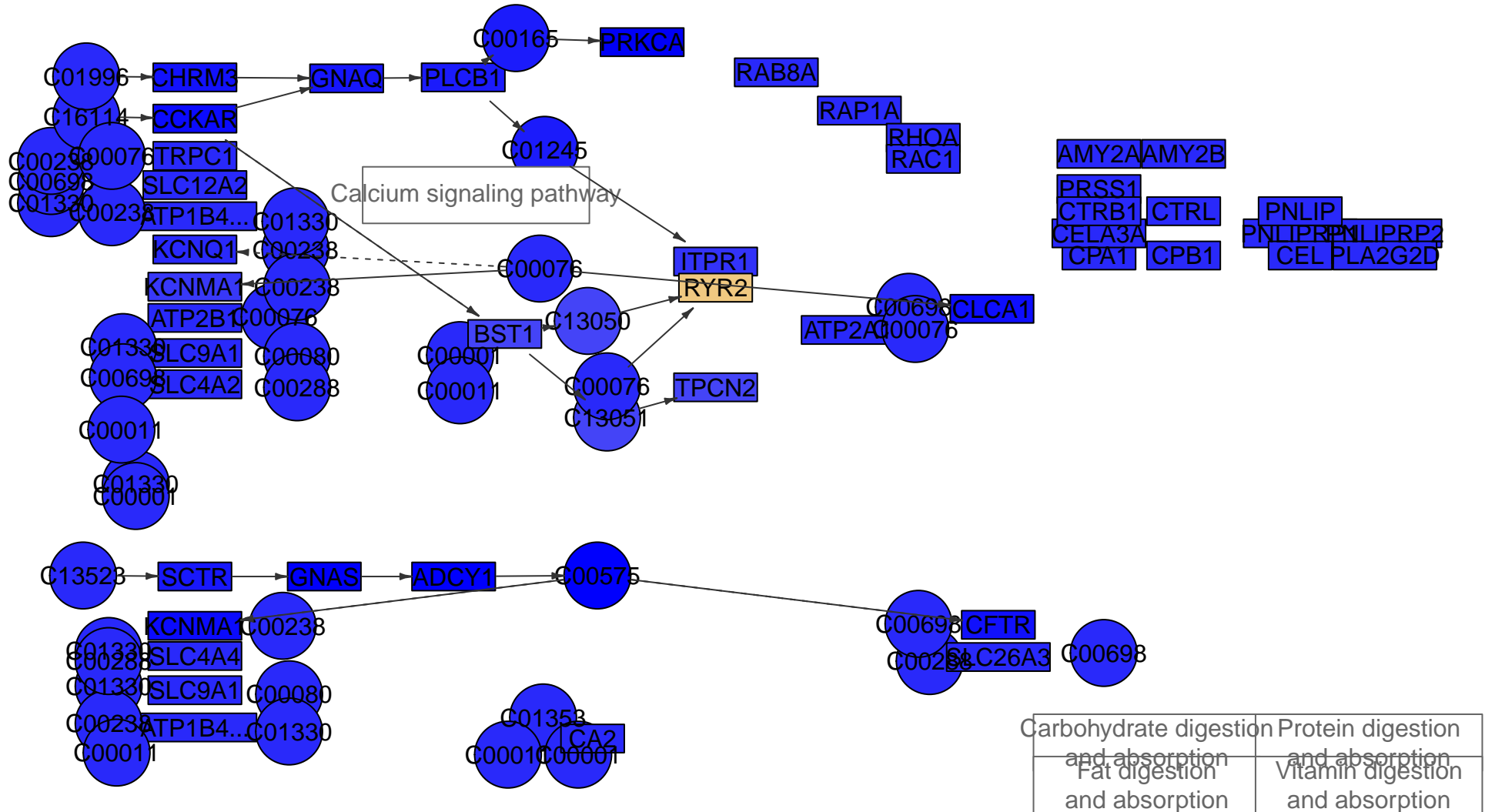

Pancreatic secretion
MPI-104



Tight junction

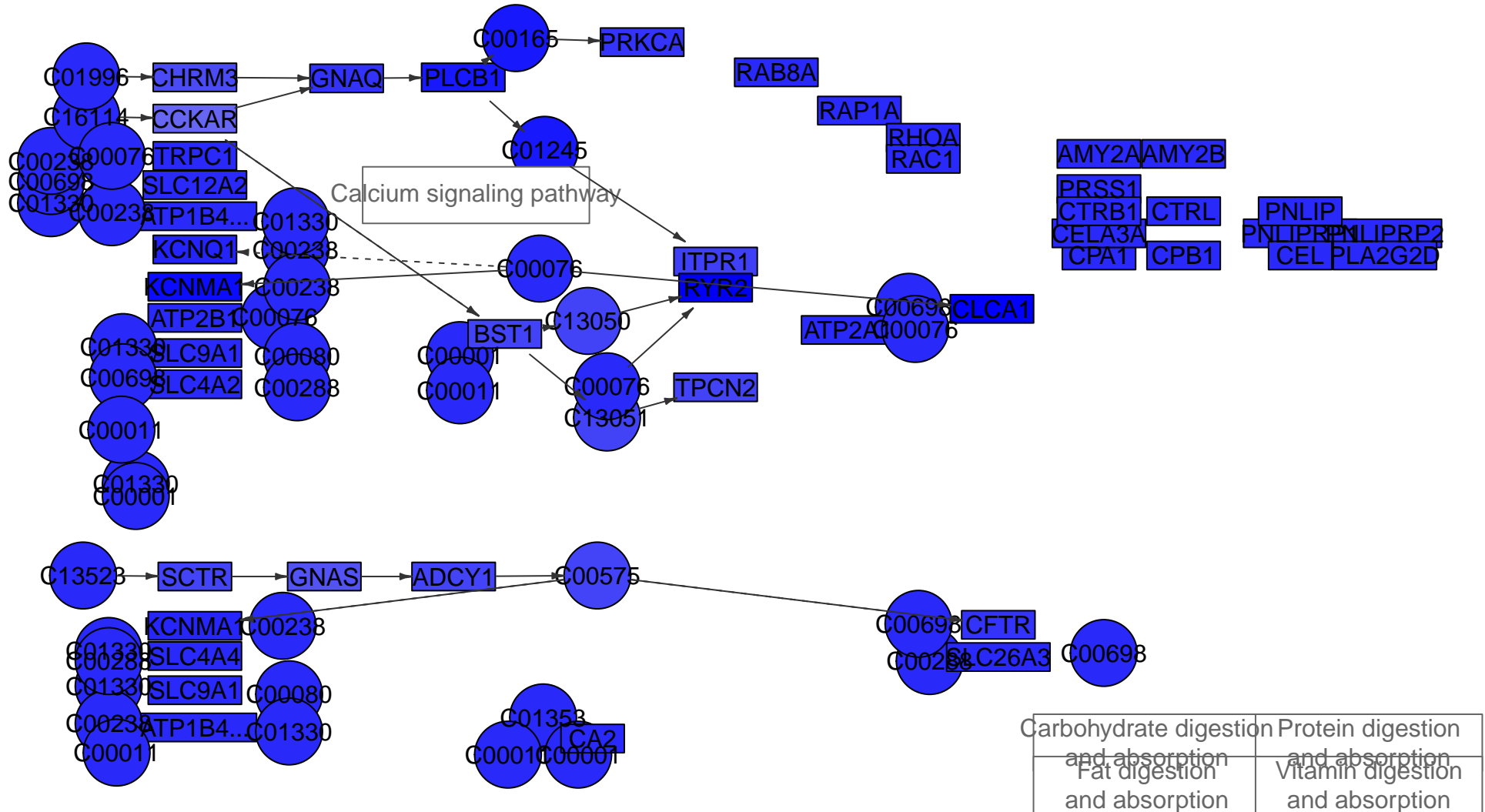

Pancreatic secretion
MPI-112



Tight junction

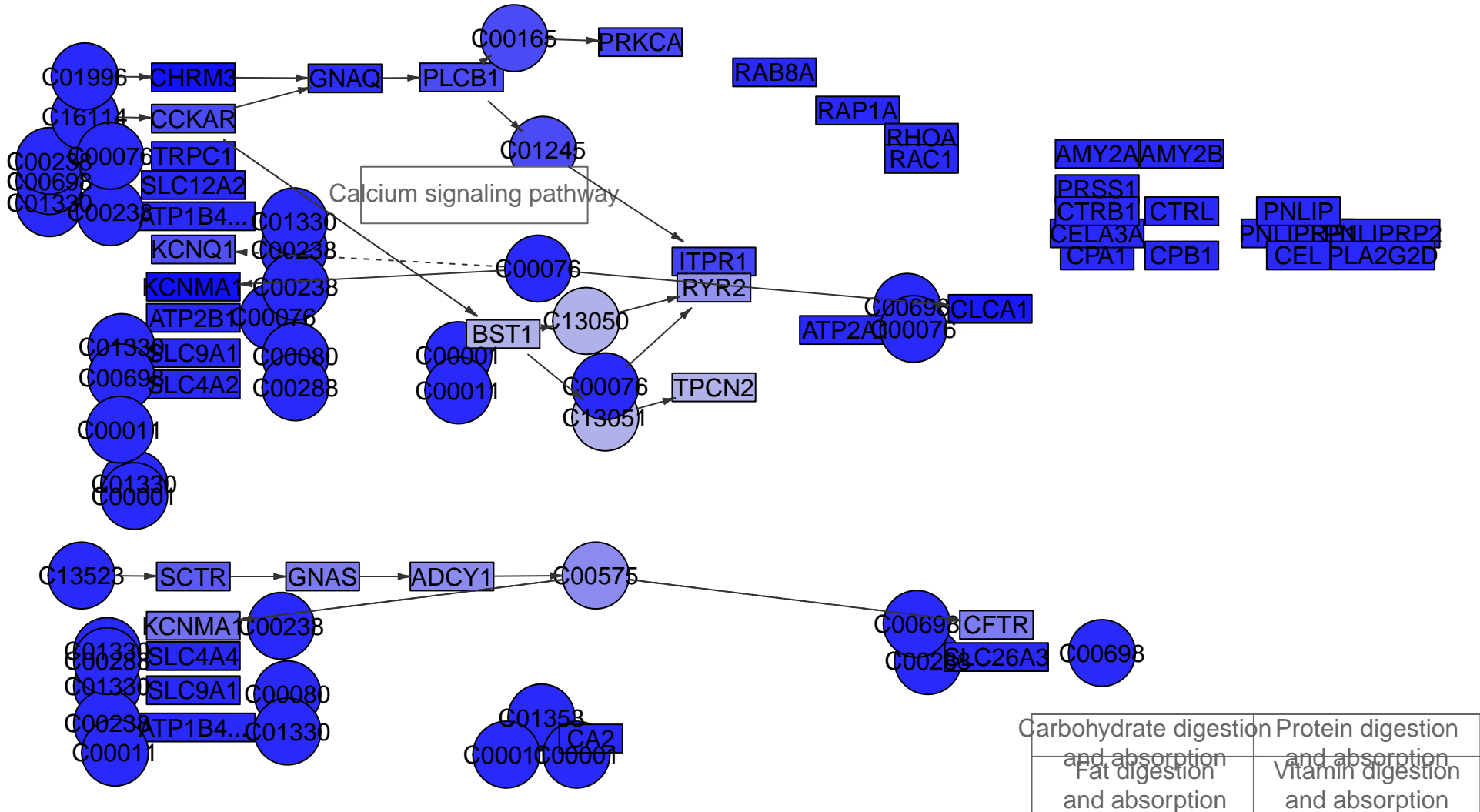

Pancreatic secretion
MPI-116

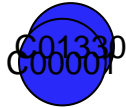

Tight junction

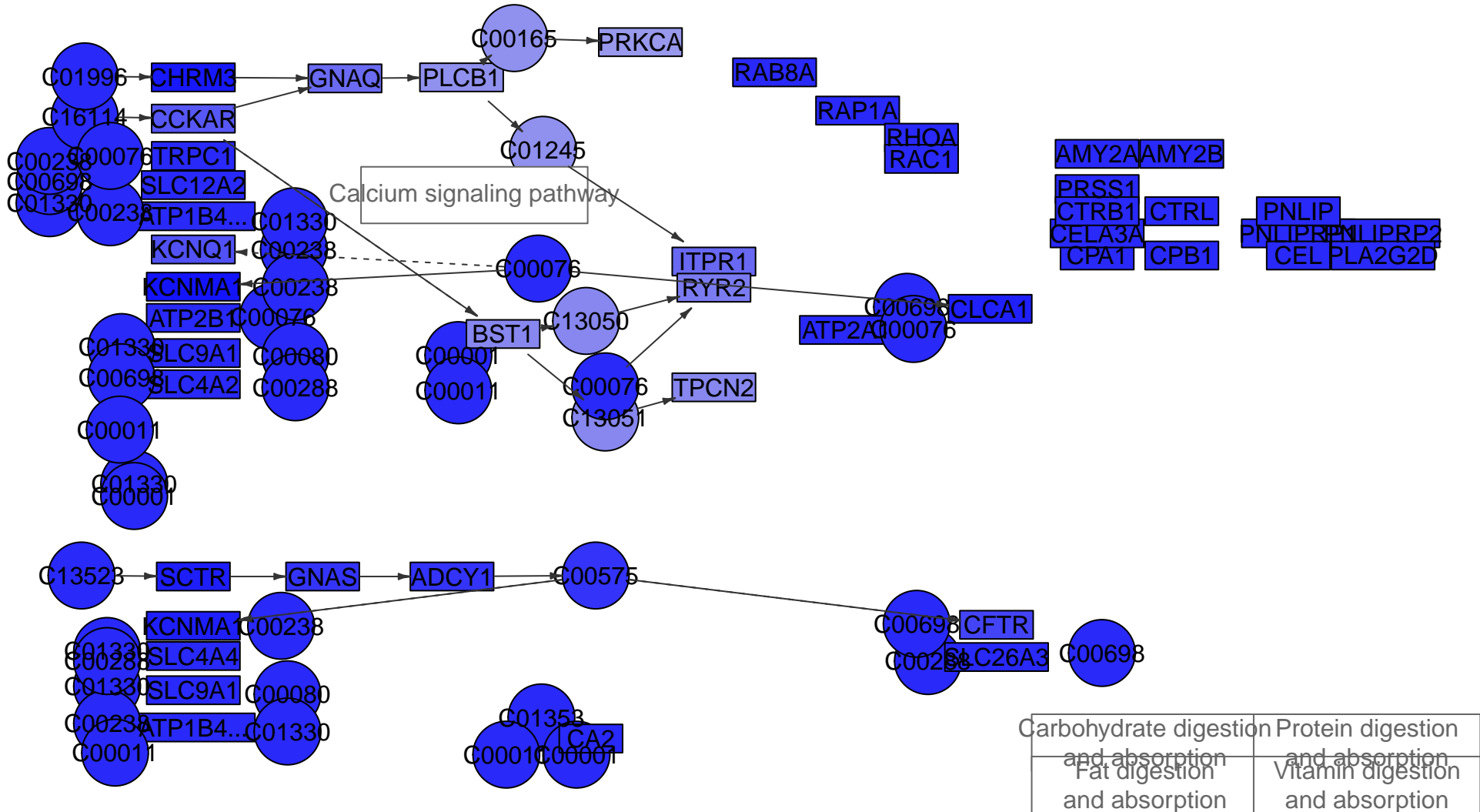

Pancreatic secretion
MPI-117



Tight junction

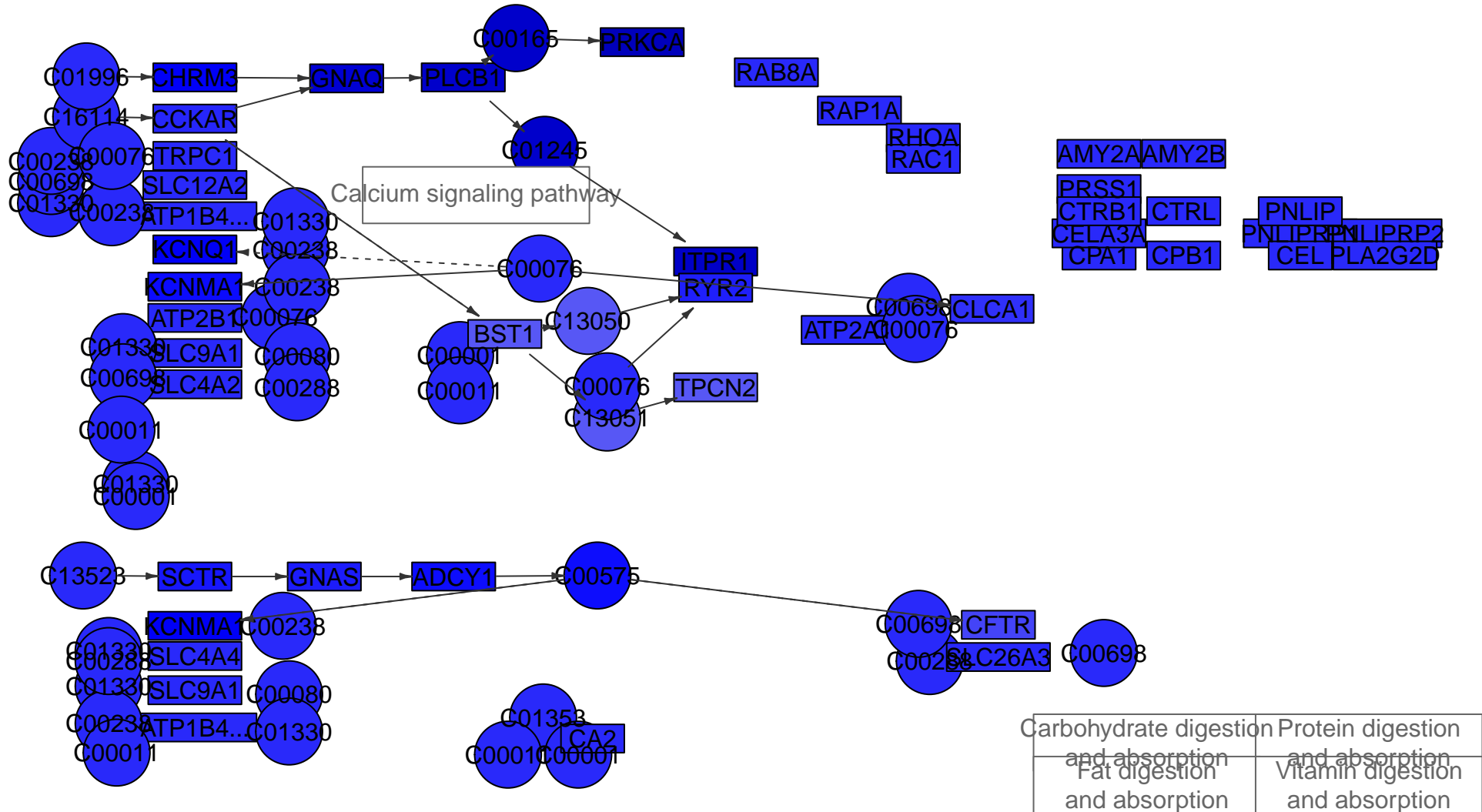

Pancreatic secretion
MPI-120



Tight junction

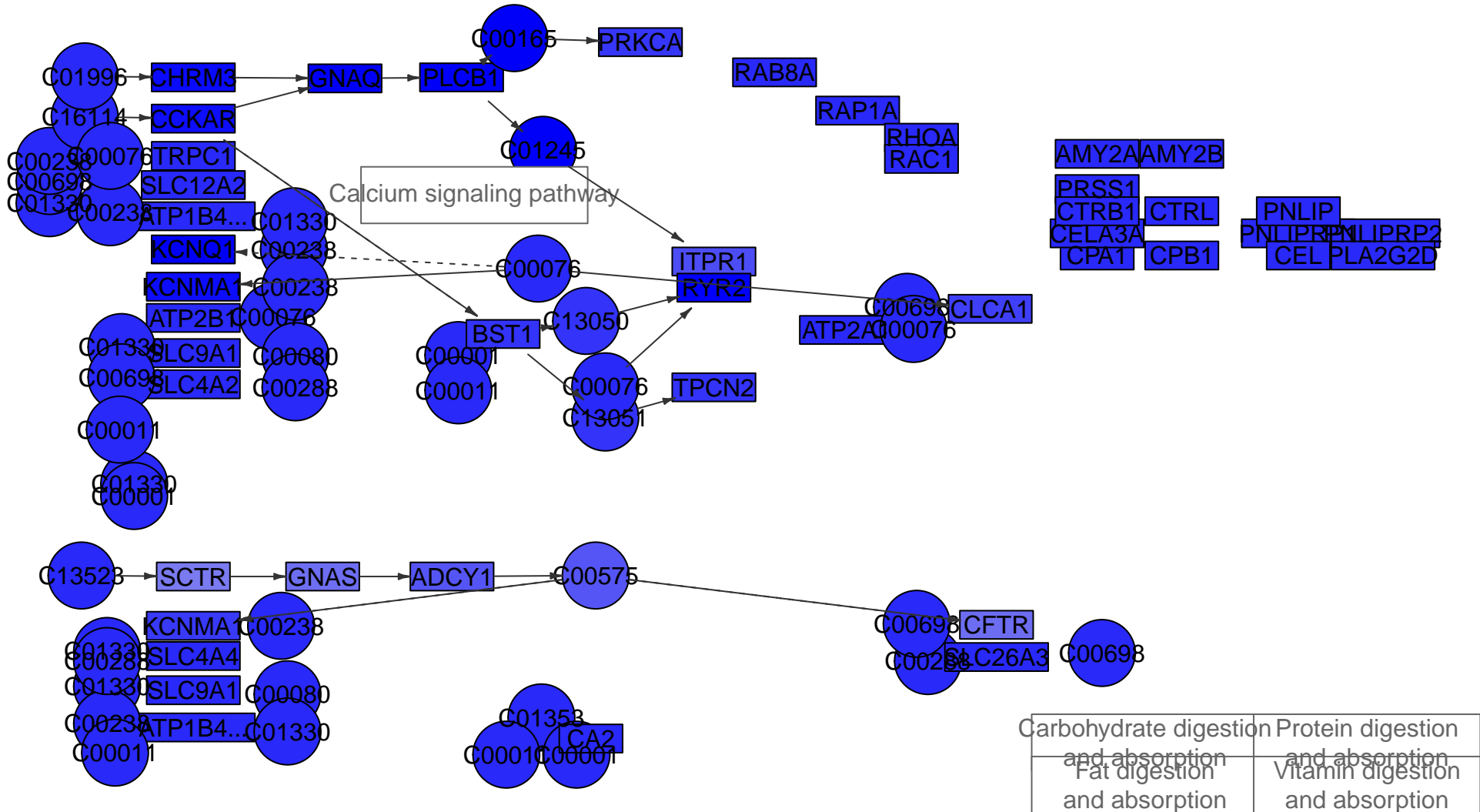

Pancreatic secretion
MPI-121



Tight junction

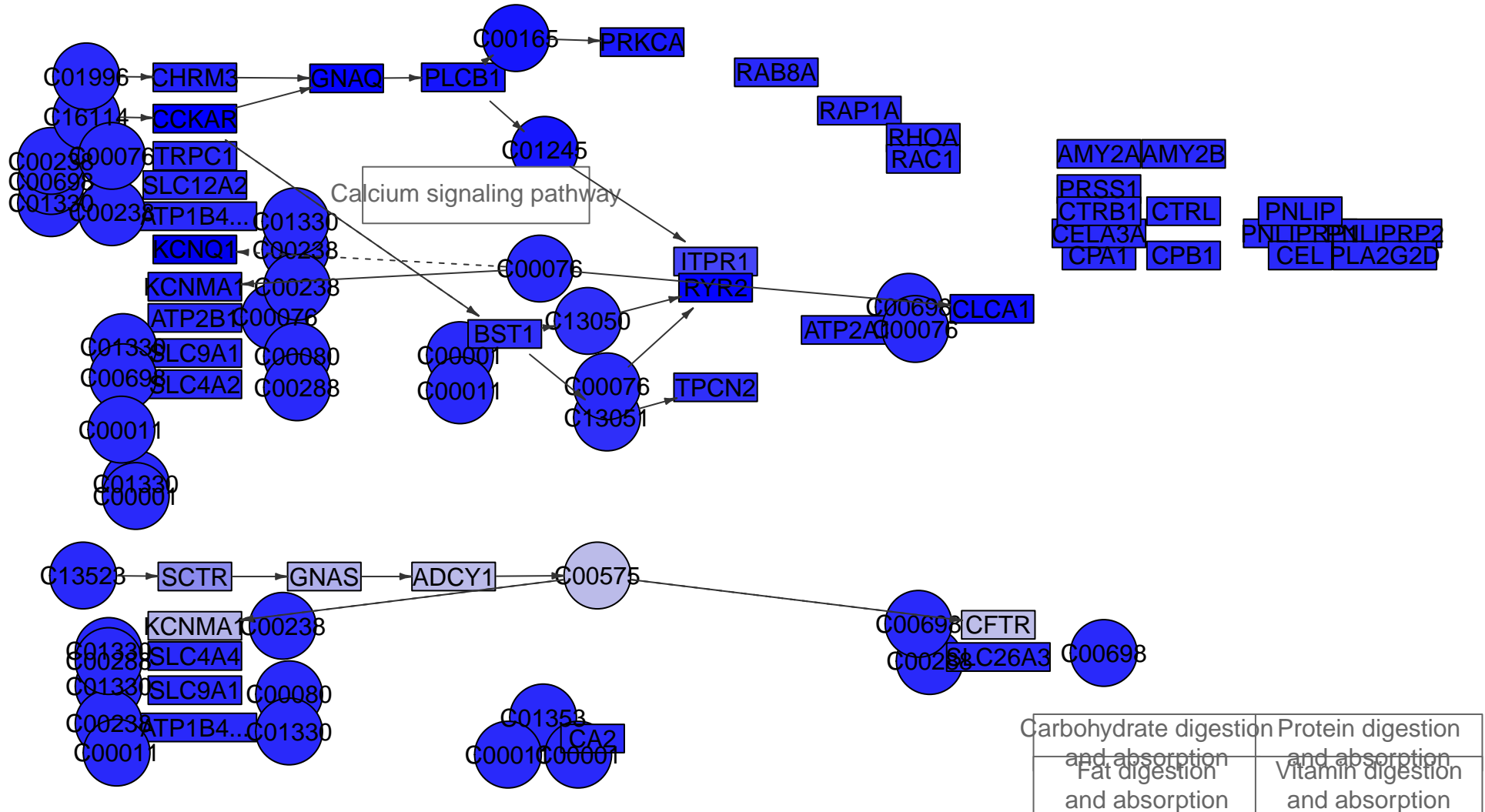

Pancreatic secretion
MPI-126



Tight junction

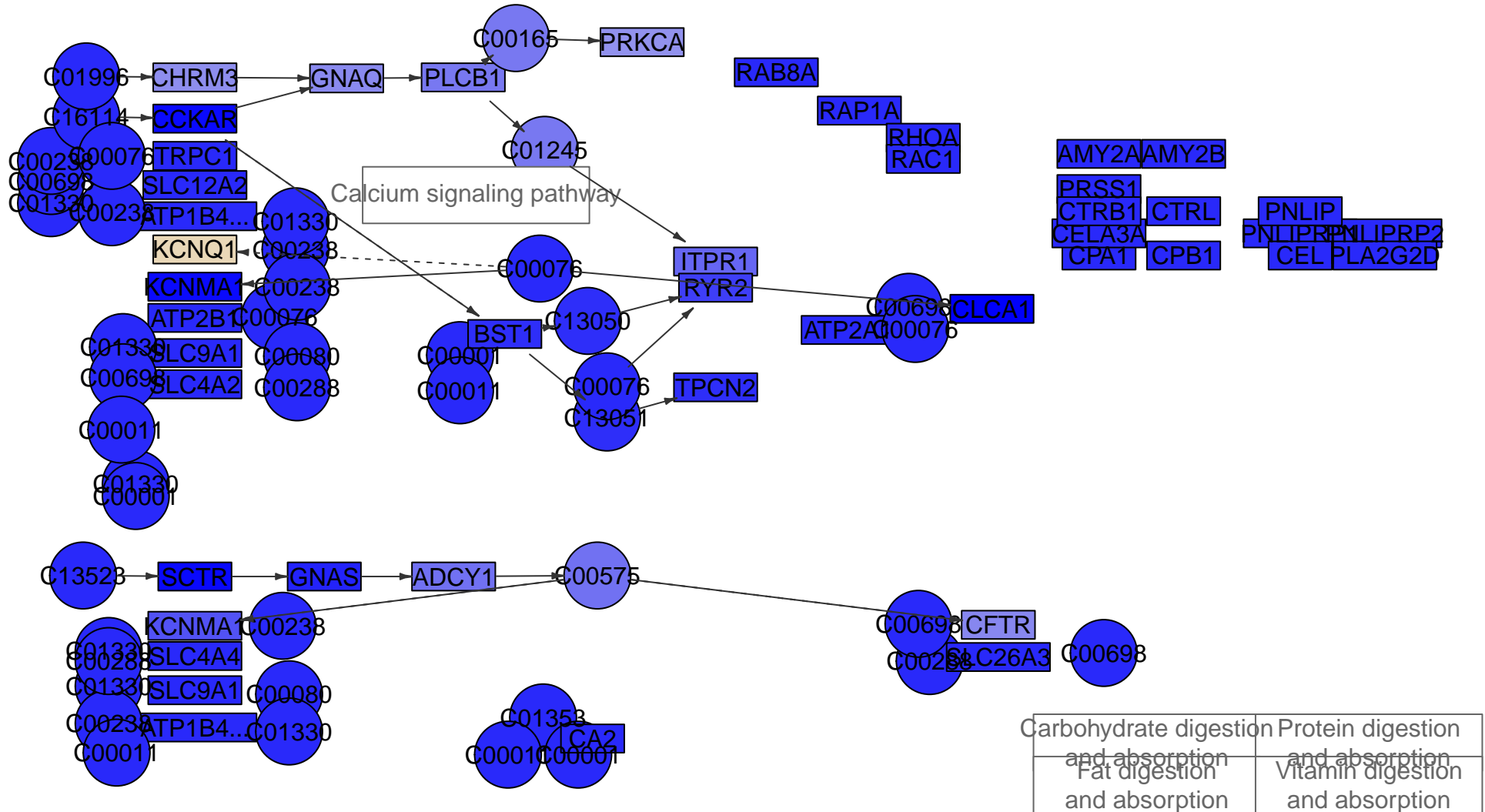

Pancreatic secretion
MPI-143



Tight junction

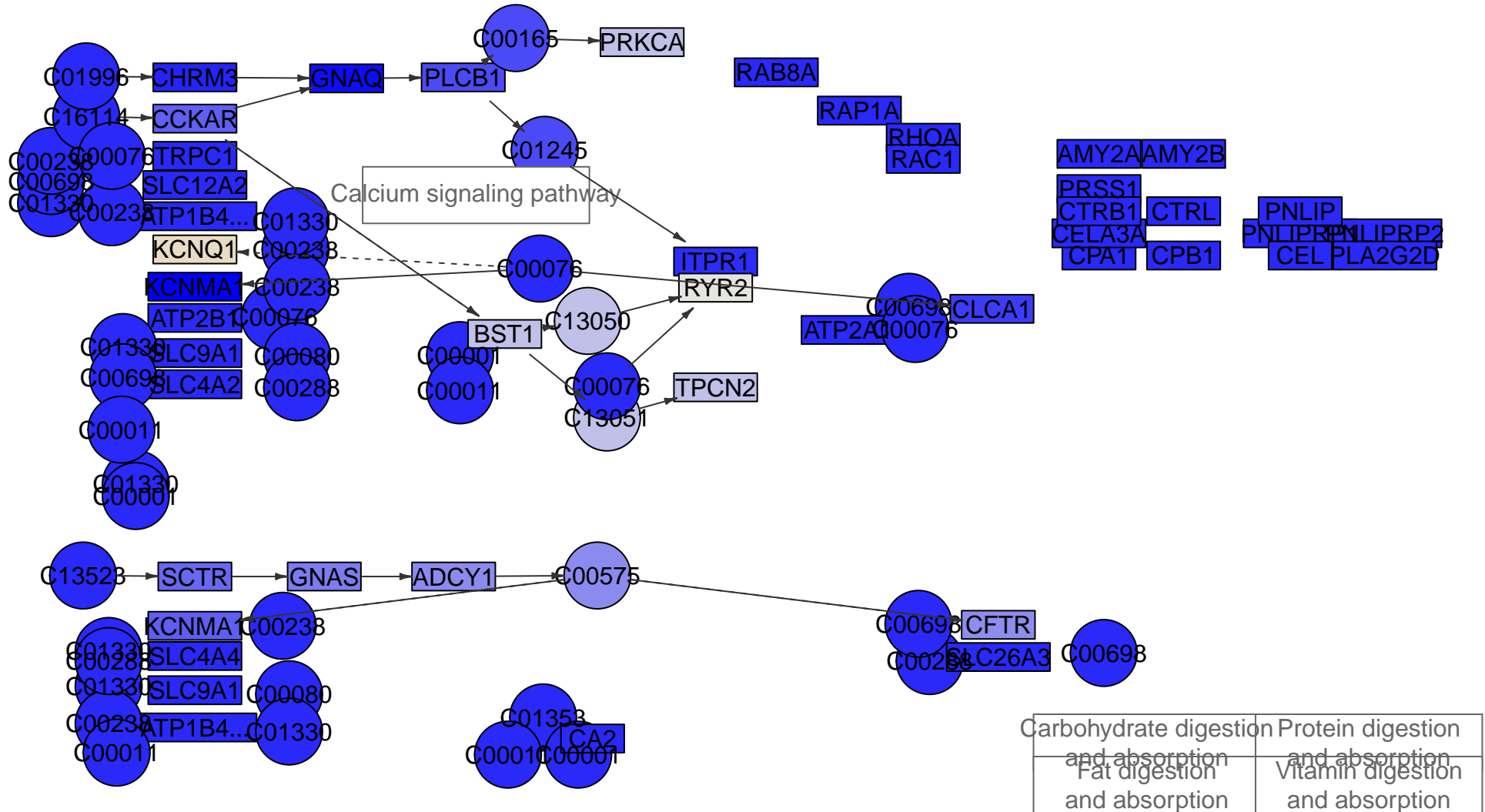

Pancreatic secretion
MPI-148



Tight junction

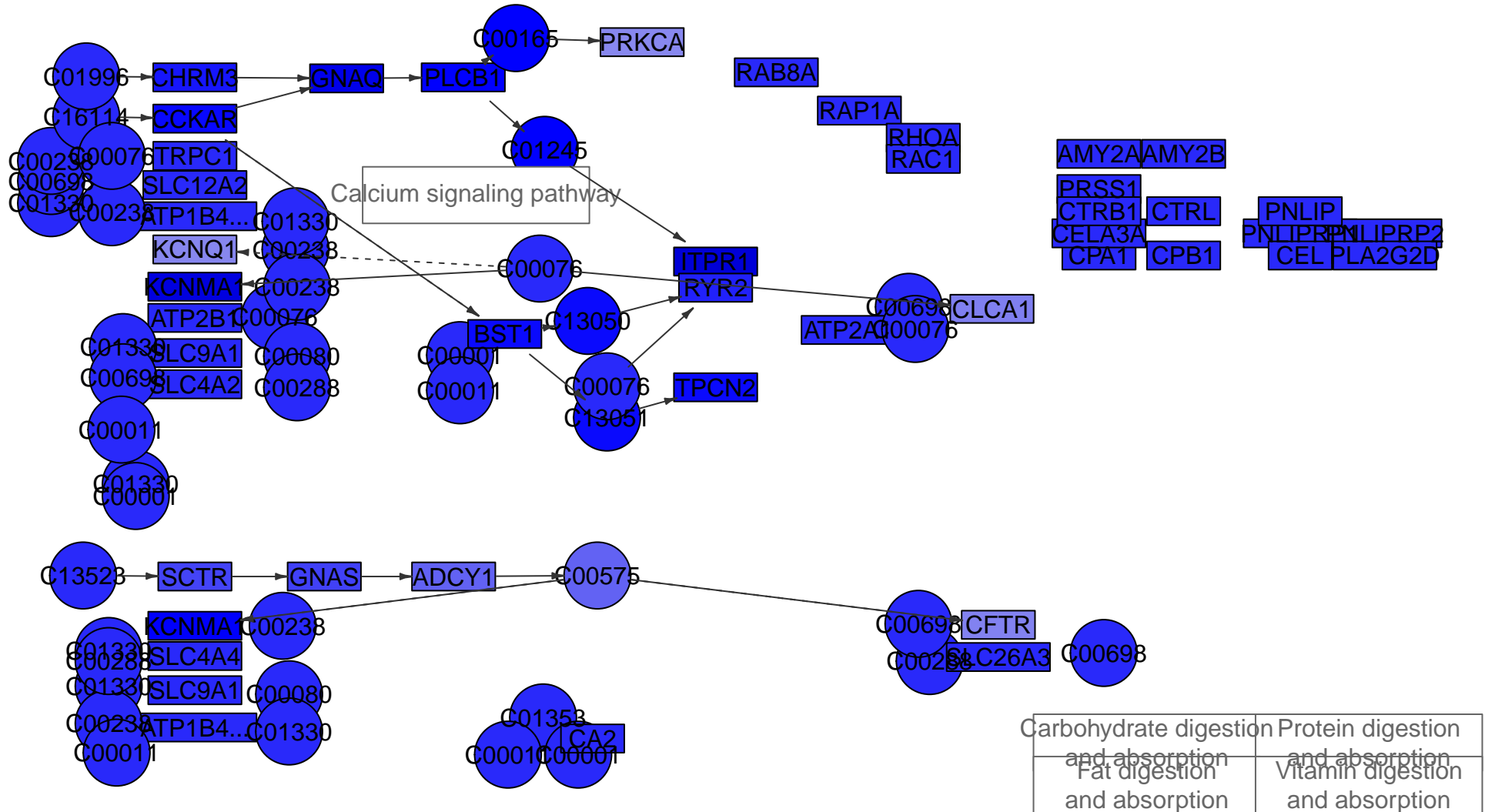

Pancreatic secretion
MPI-161

Tight junction

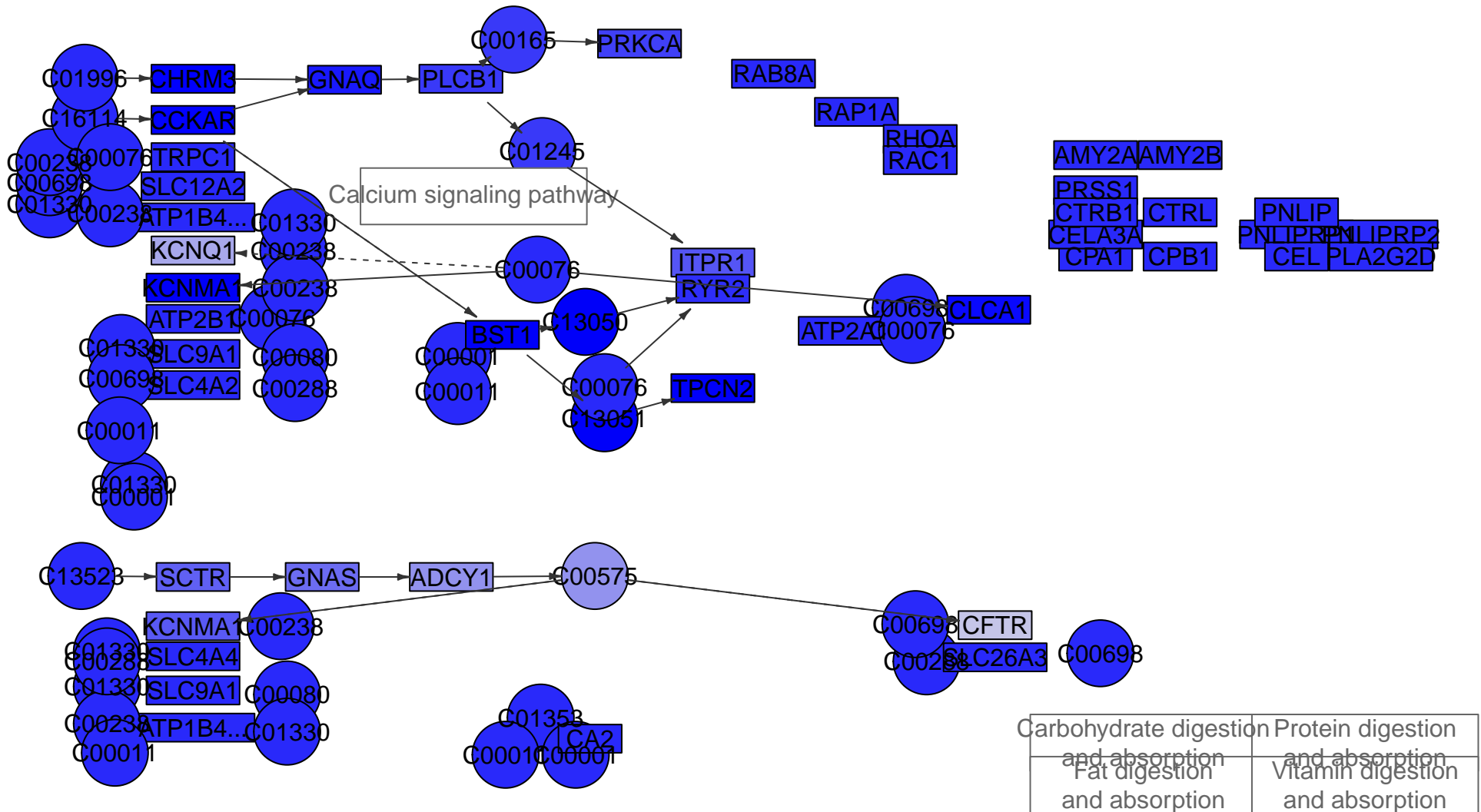

Carbohydrate digestion and absorption	Protein digestion and absorption
Fat digestion and absorption	Vitamin digestion and absorption

Pancreatic secretion
MPI-162

Tight junction

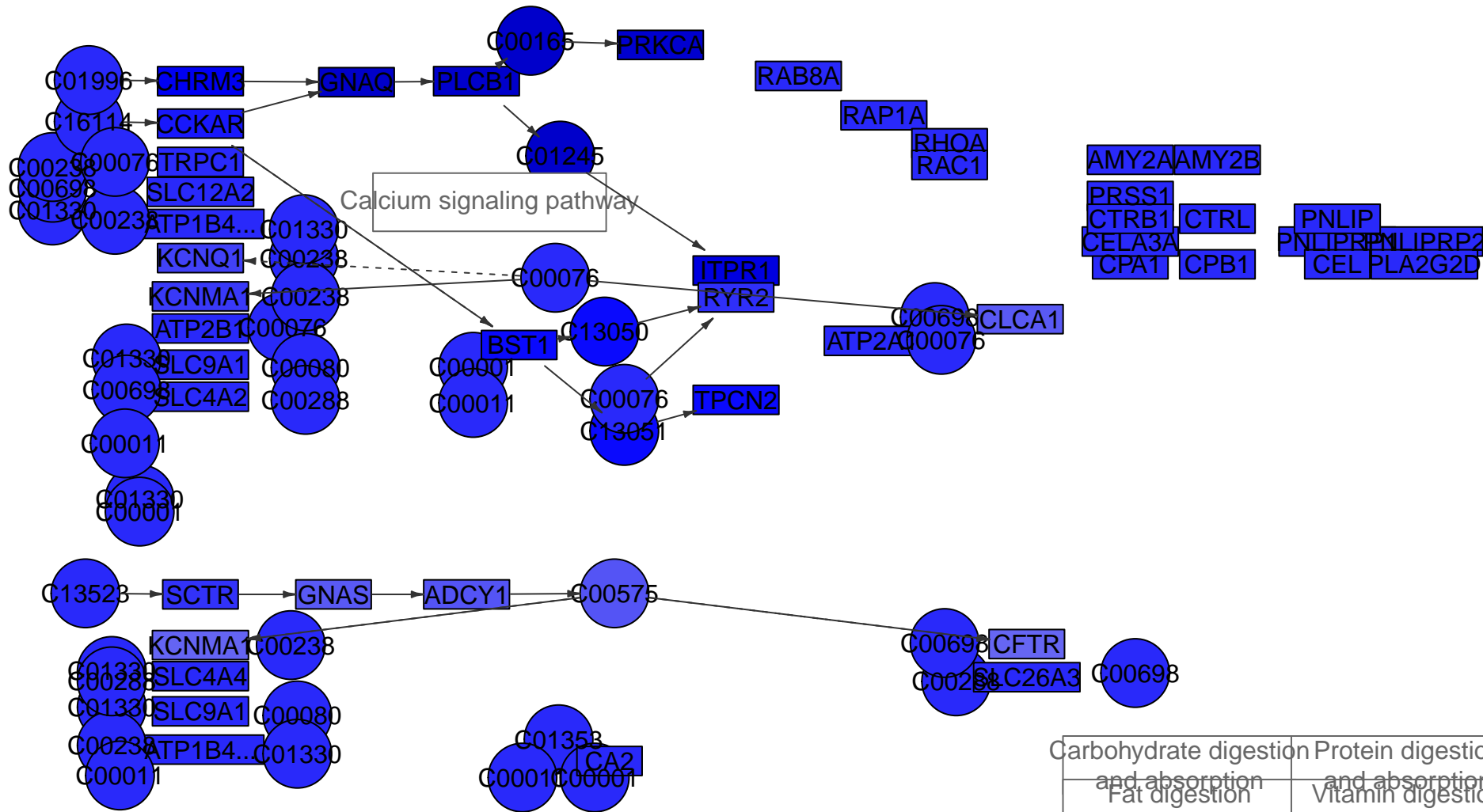

Carbohydrate digestion and absorption	Protein digestion and absorption
Fat digestion and absorption	Vitamin digestion and absorption

Pancreatic secretion
MPI-165



Tight junction

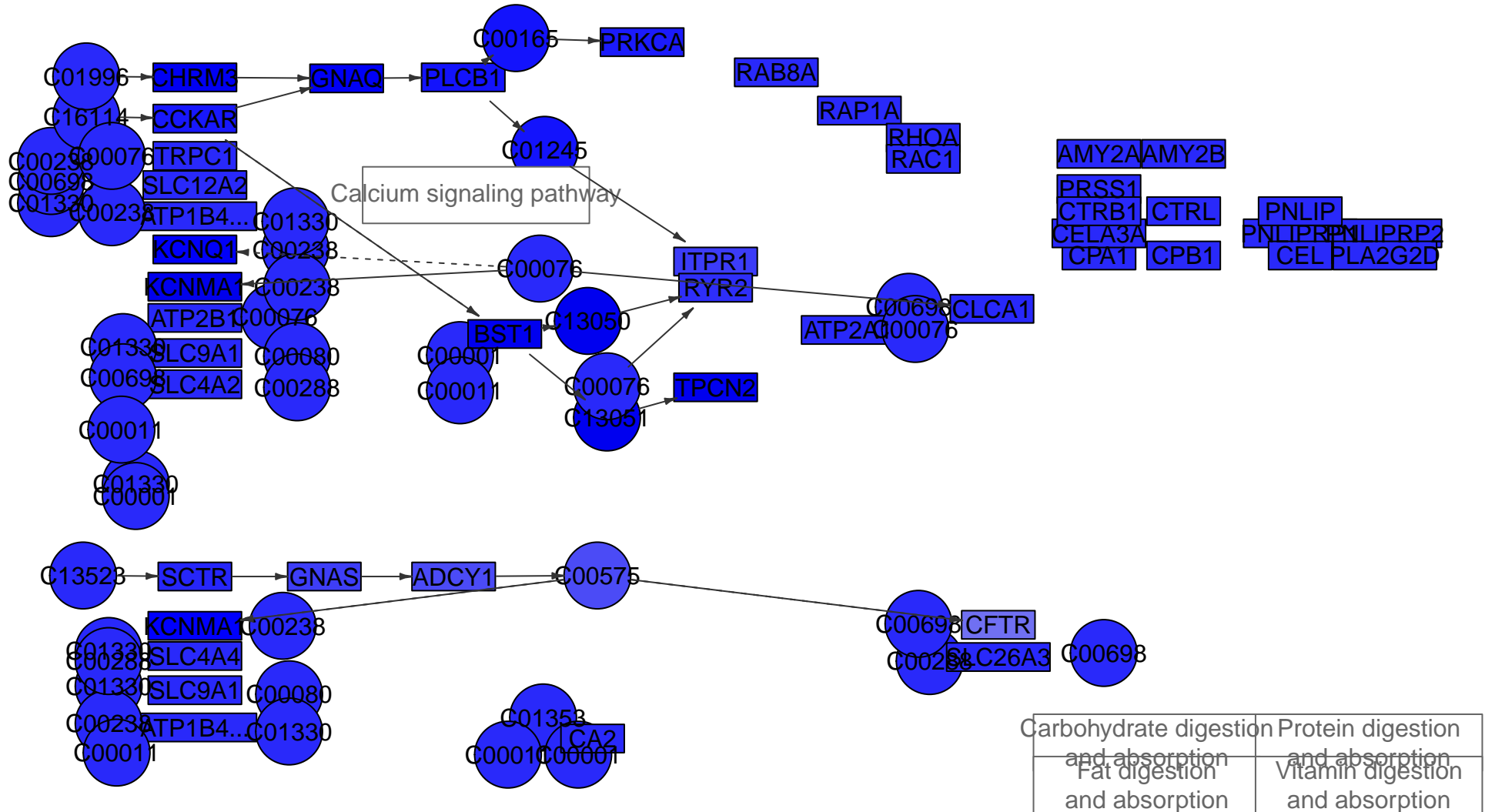

Pancreatic secretion
MPI-169



Tight junction

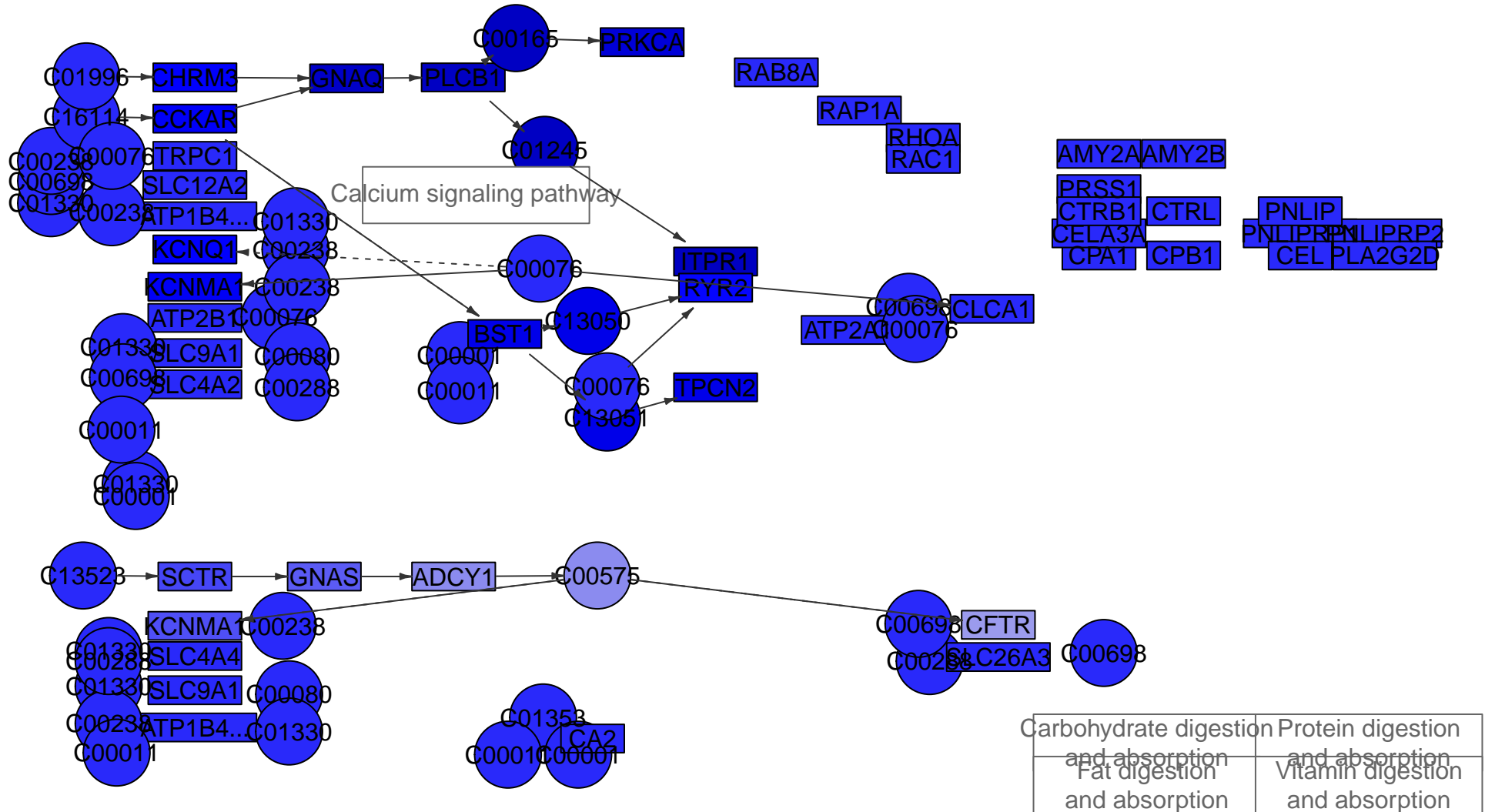

Pancreatic secretion
MPI-175



Tight junction

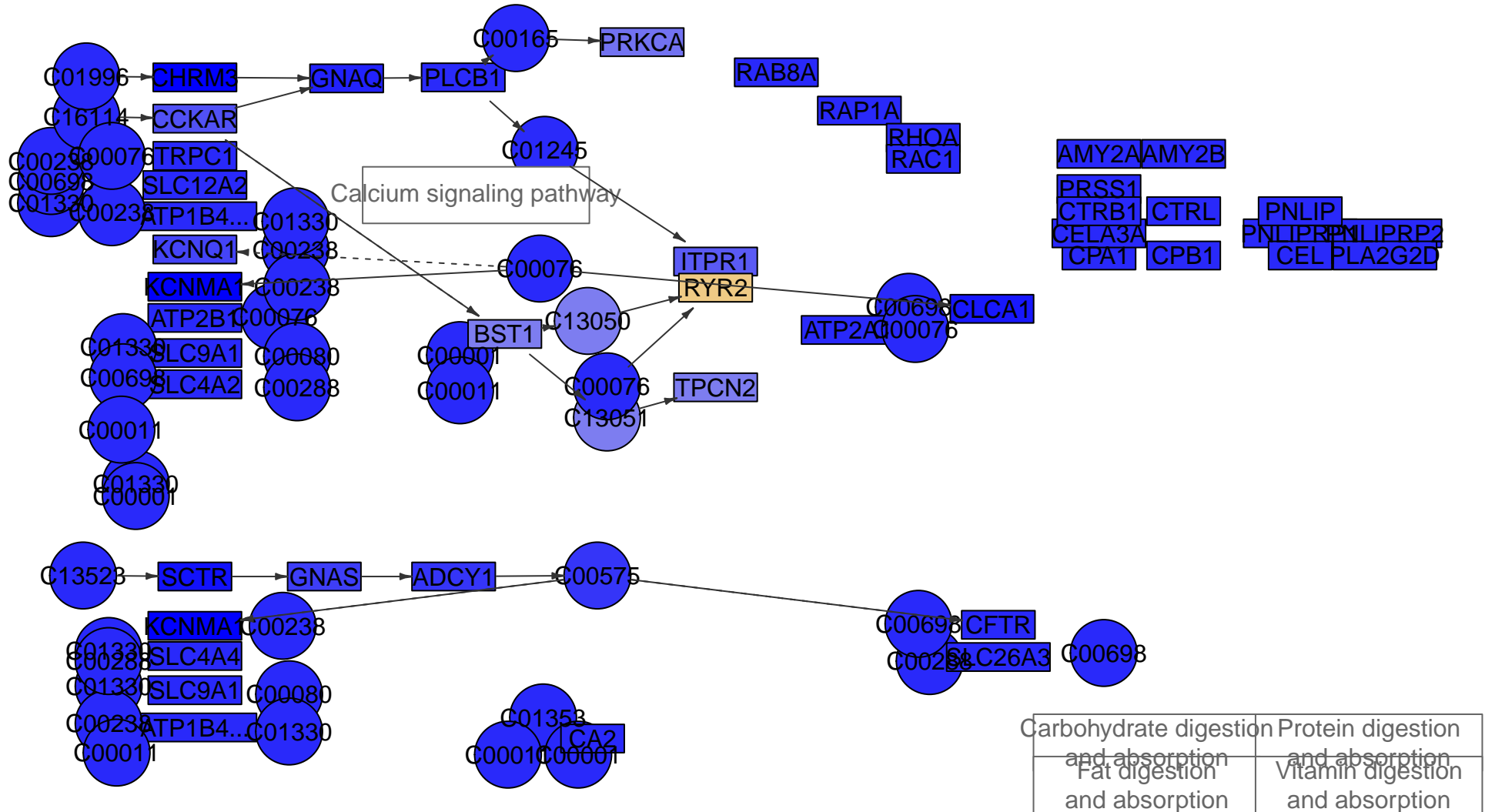

Pancreatic secretion
MPI-187

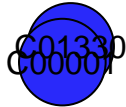

Tight junction

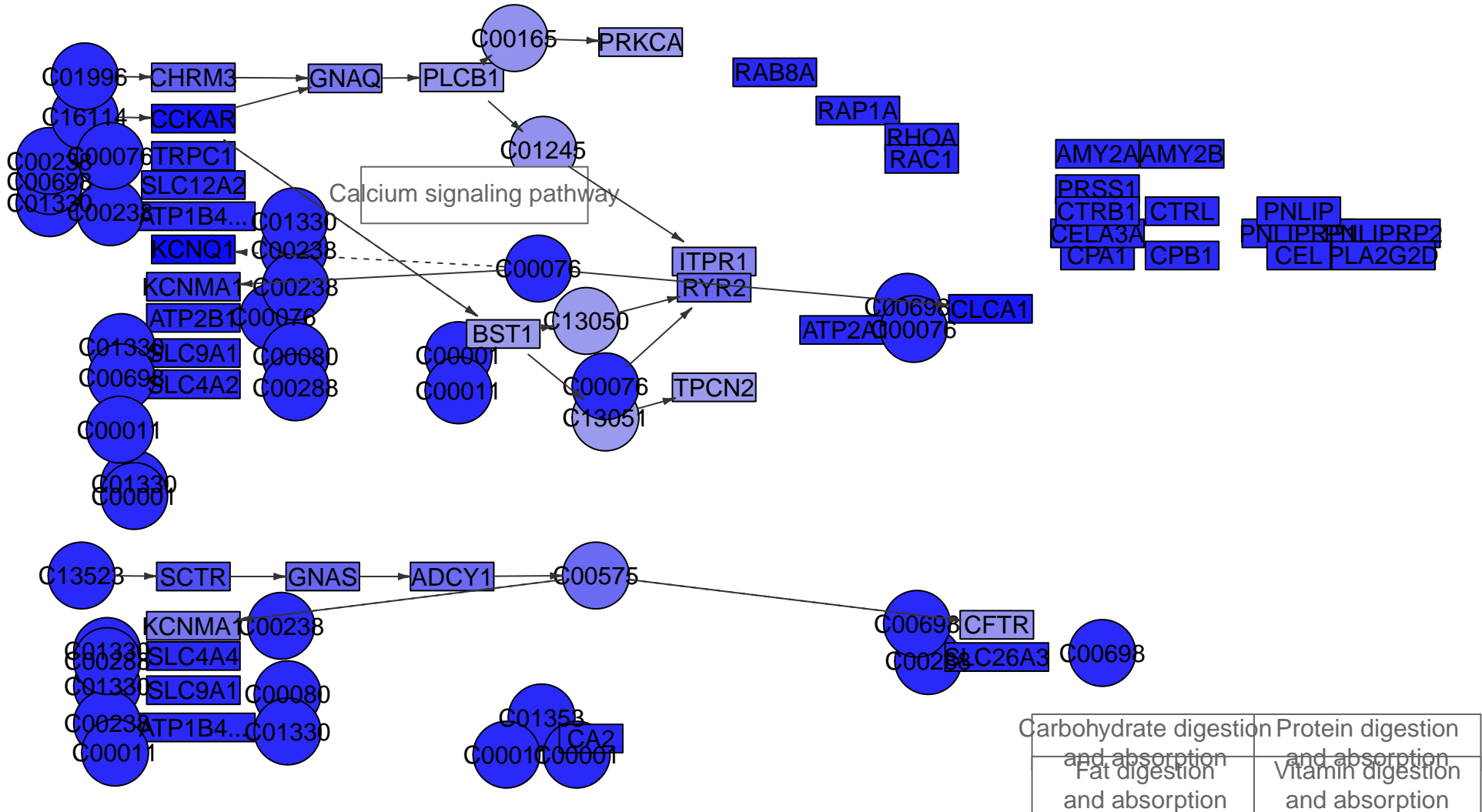

Pancreatic secretion
MPI-193

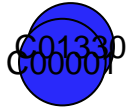

Tight junction

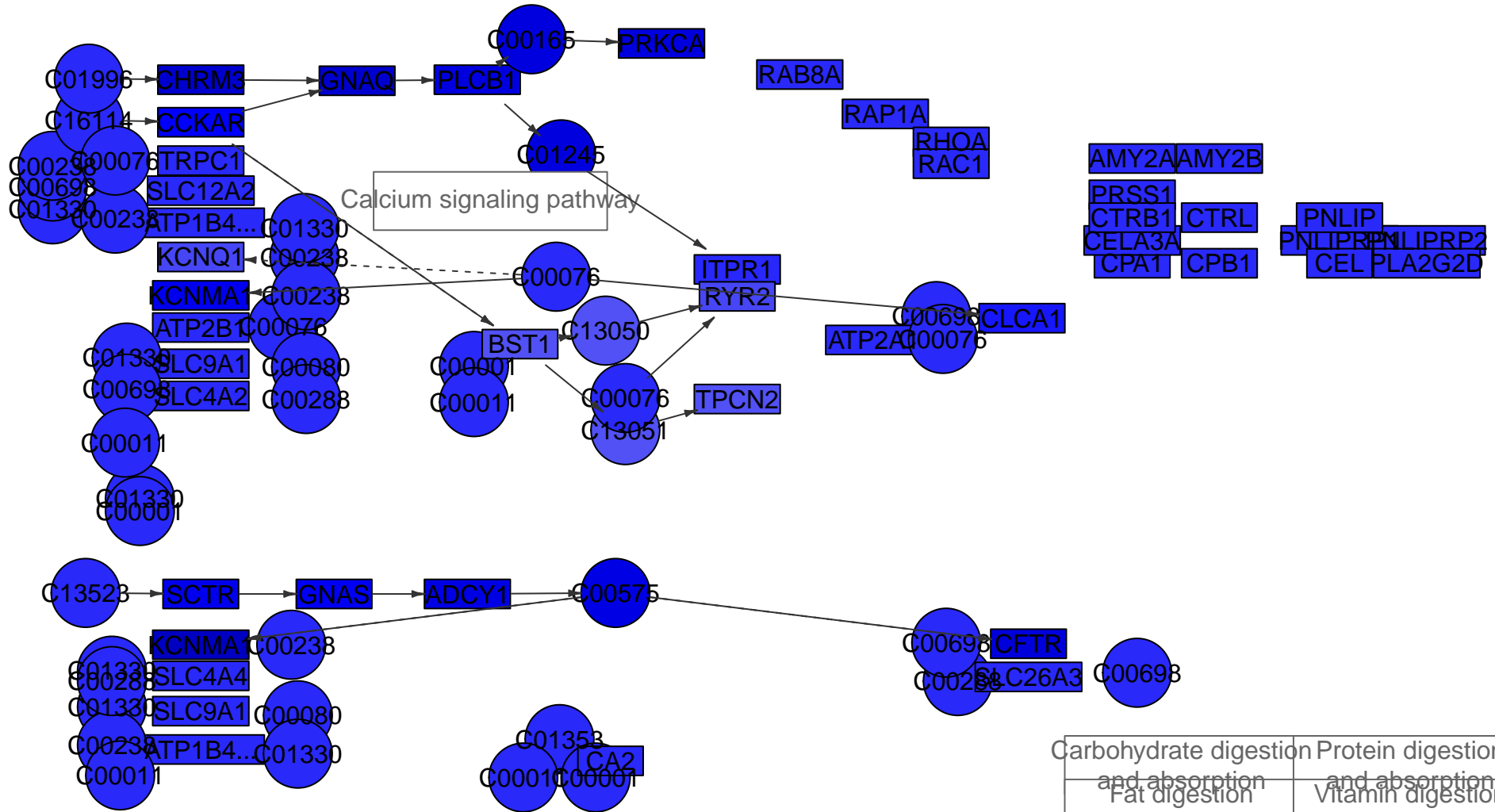

Pancreatic secretion
MPI-216



Tight junction

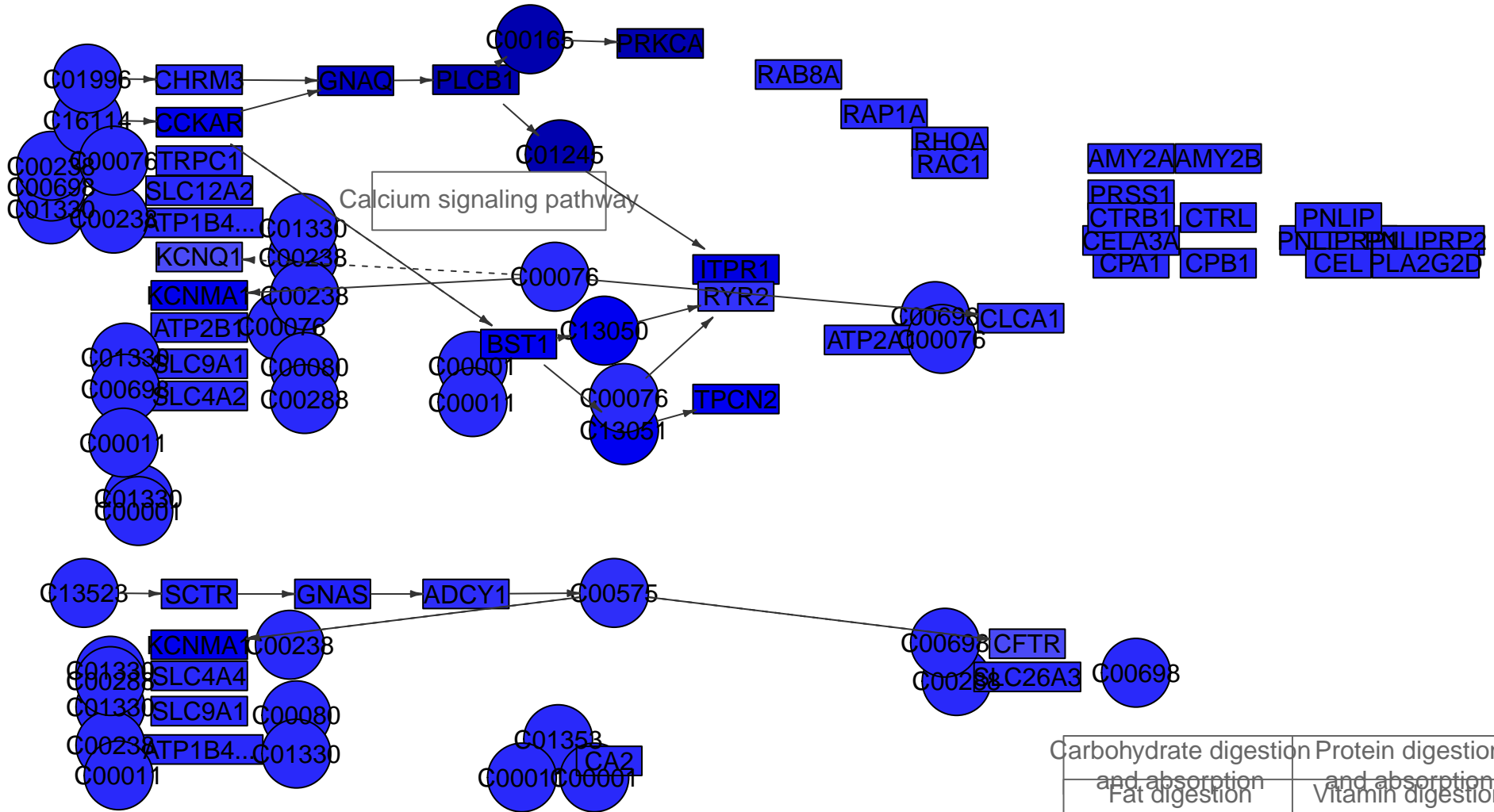

Pancreatic secretion
MPI-222



Tight junction

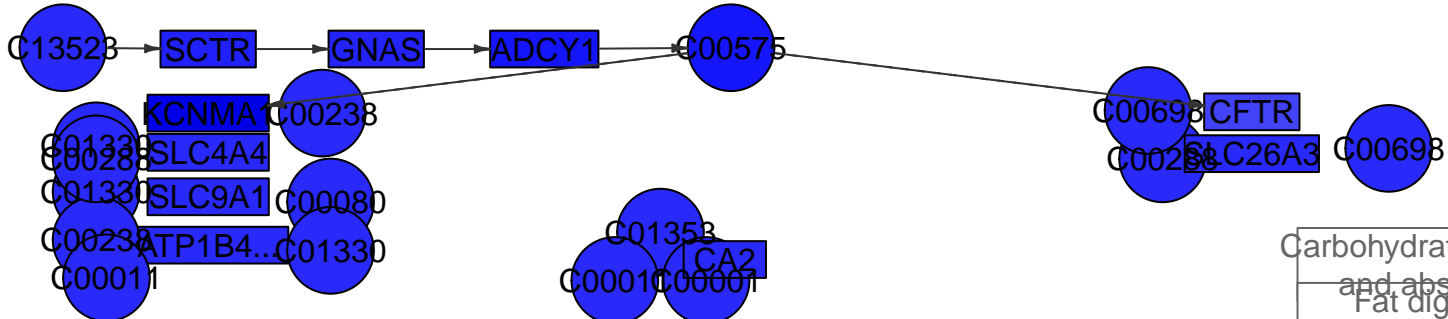
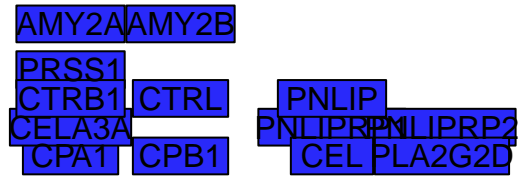
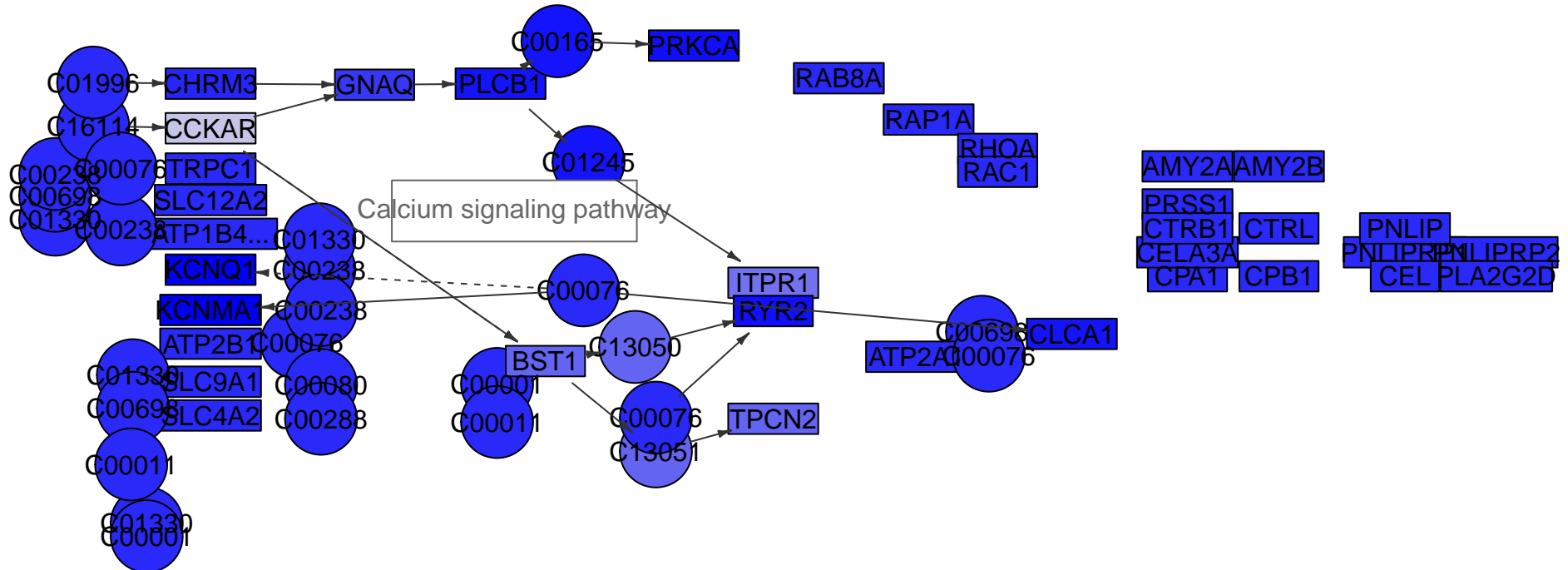

Carbohydrate digestion and absorption	Protein digestion and absorption
Fat digestion and absorption	Vitamin digestion and absorption

Pancreatic secretion
MPI-225

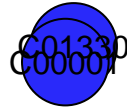

Tight junction

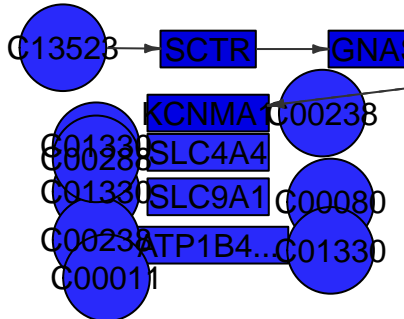
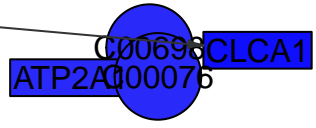
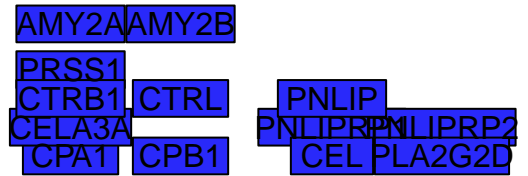
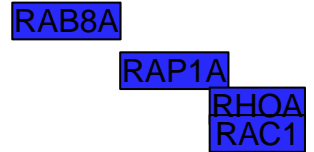
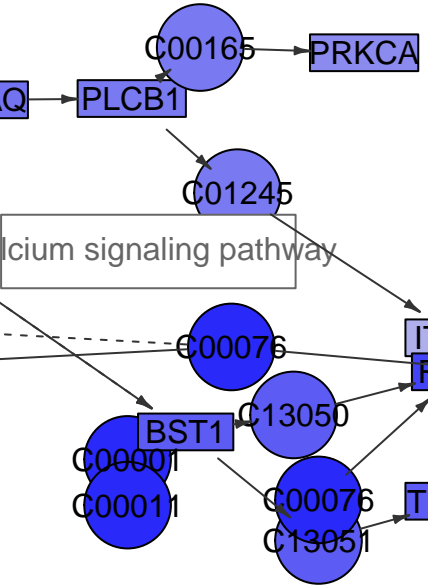
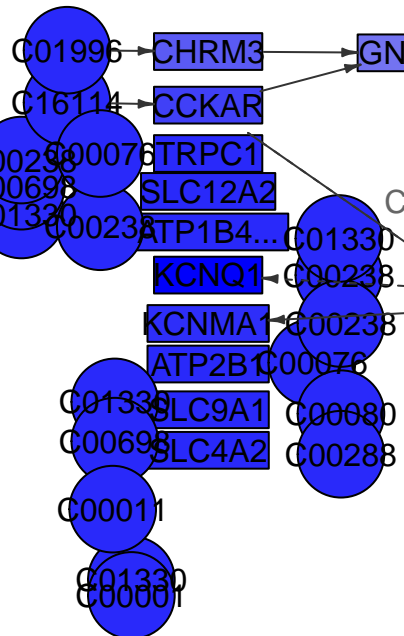
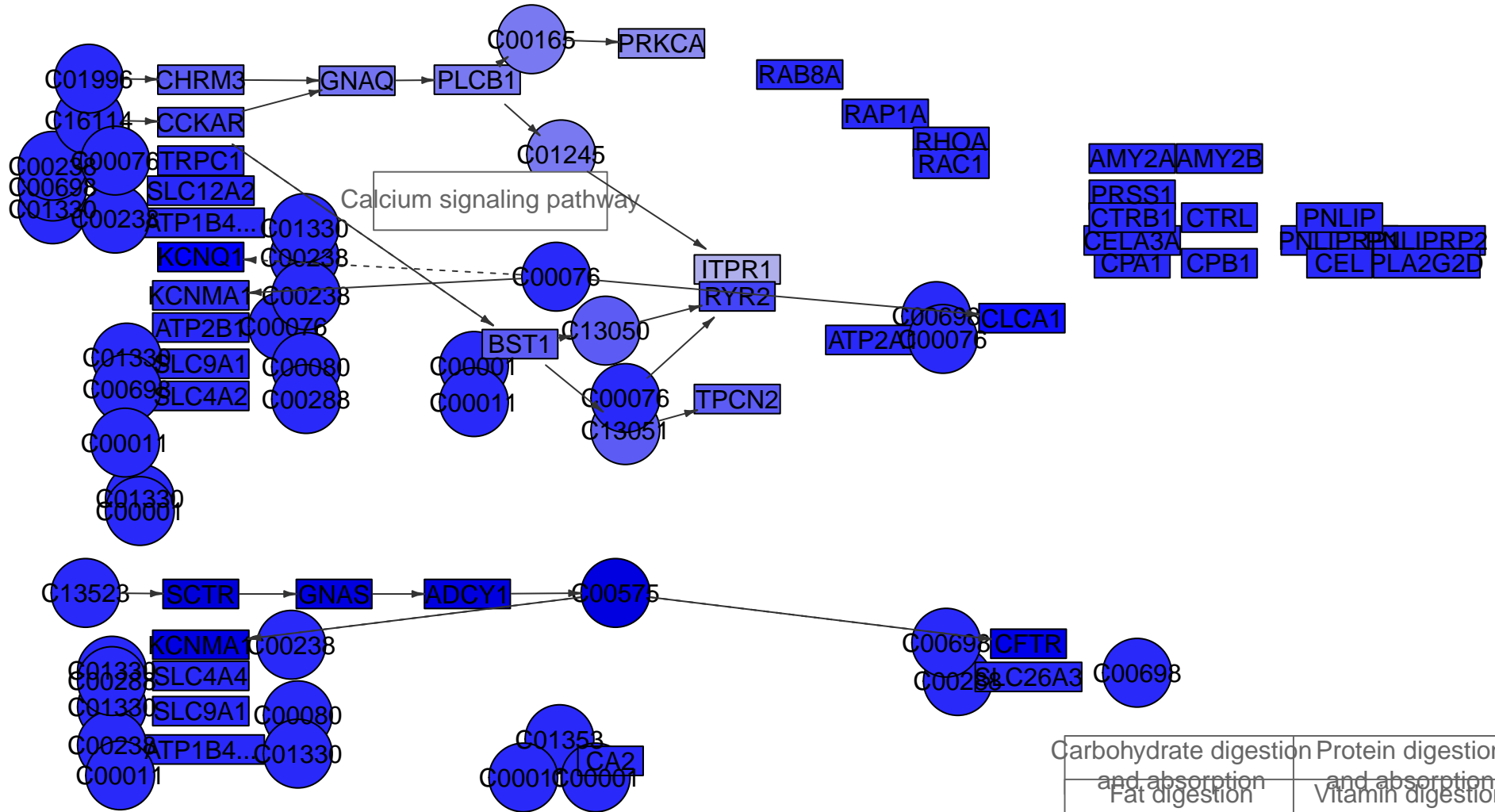

Pancreatic secretion
MPI-242

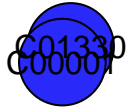

Tight junction

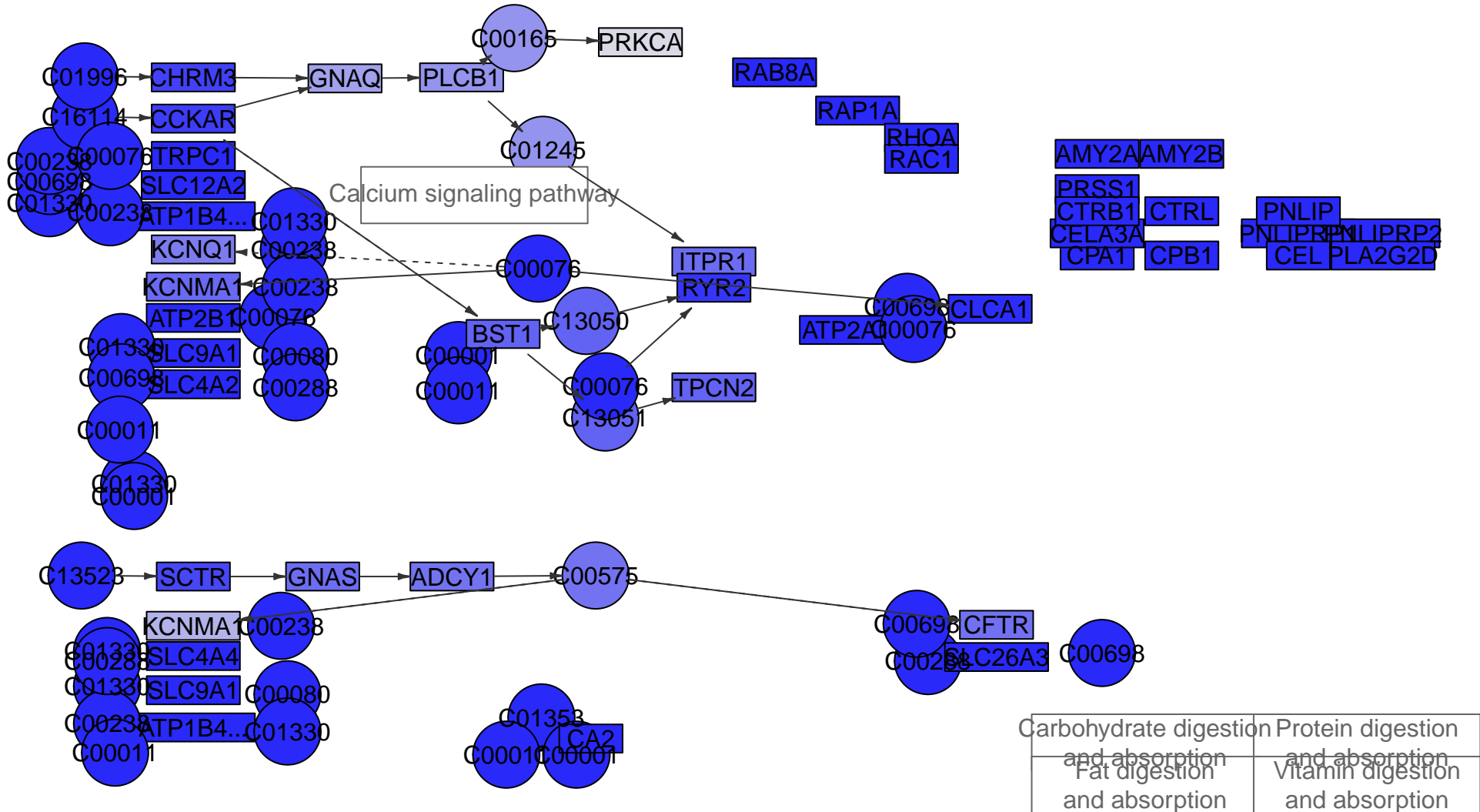

Pancreatic secretion
MPI-245



Tight junction

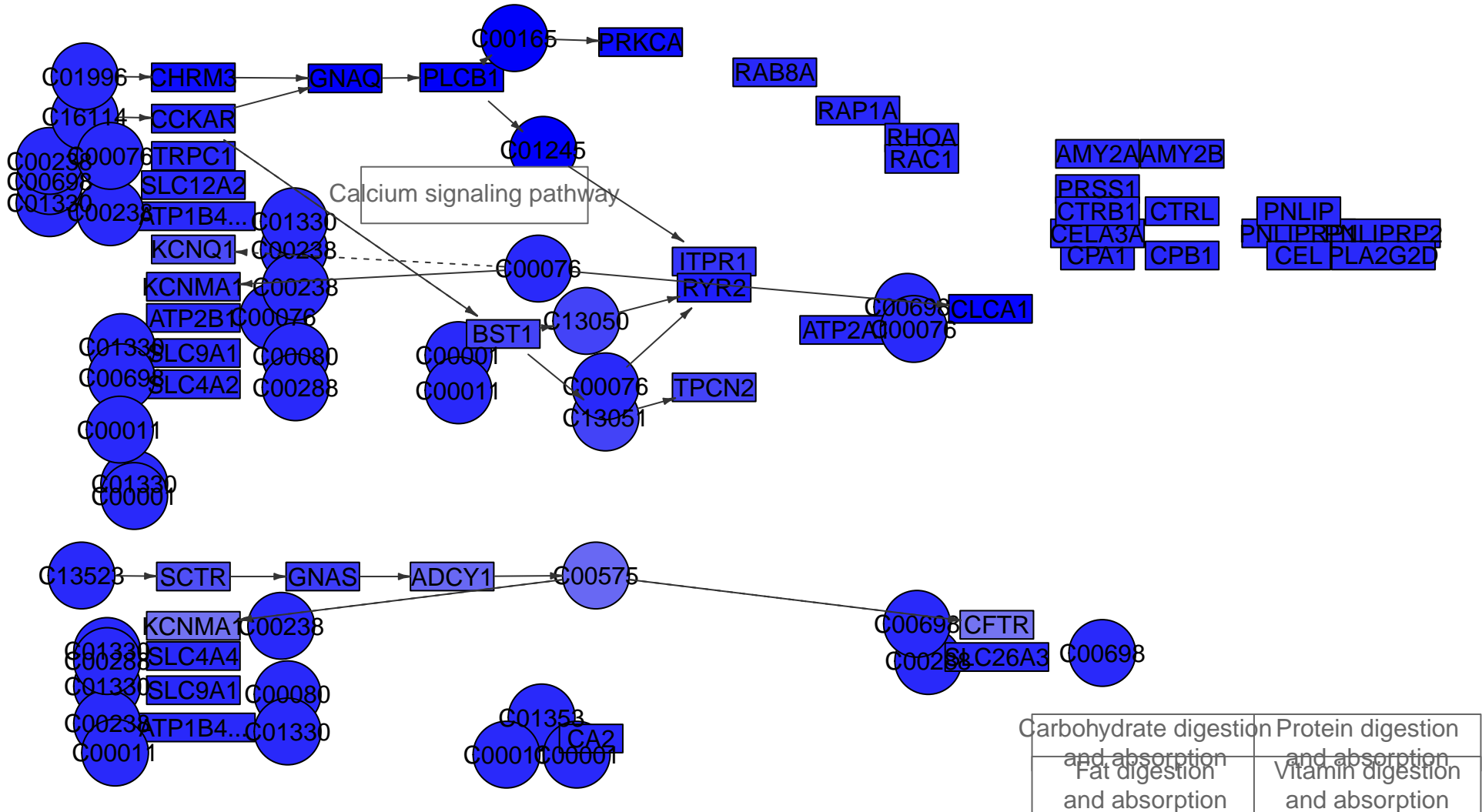

Pancreatic secretion
MPI-248



Tight junction

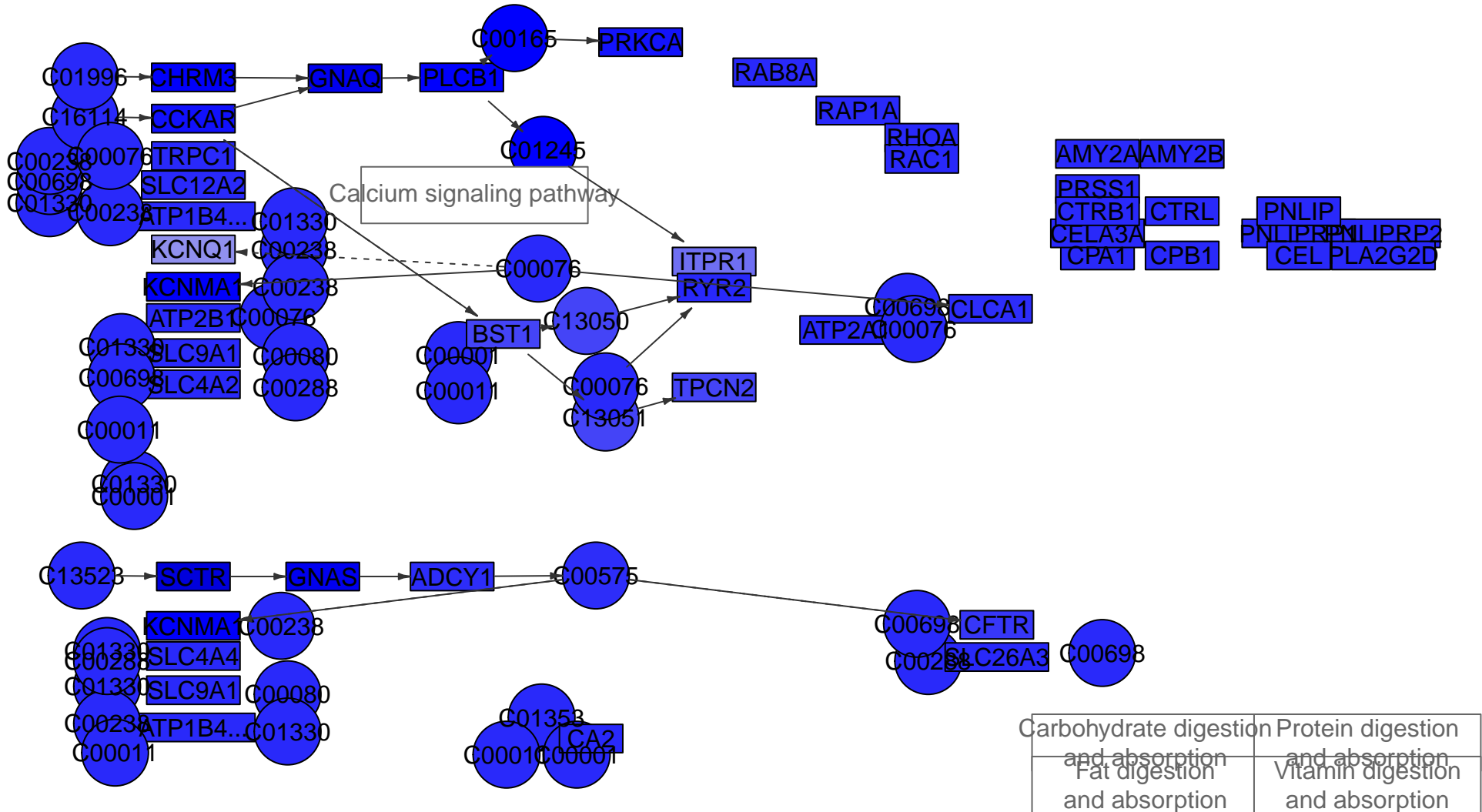

Pancreatic secretion
MPI-249

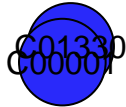

Tight junction

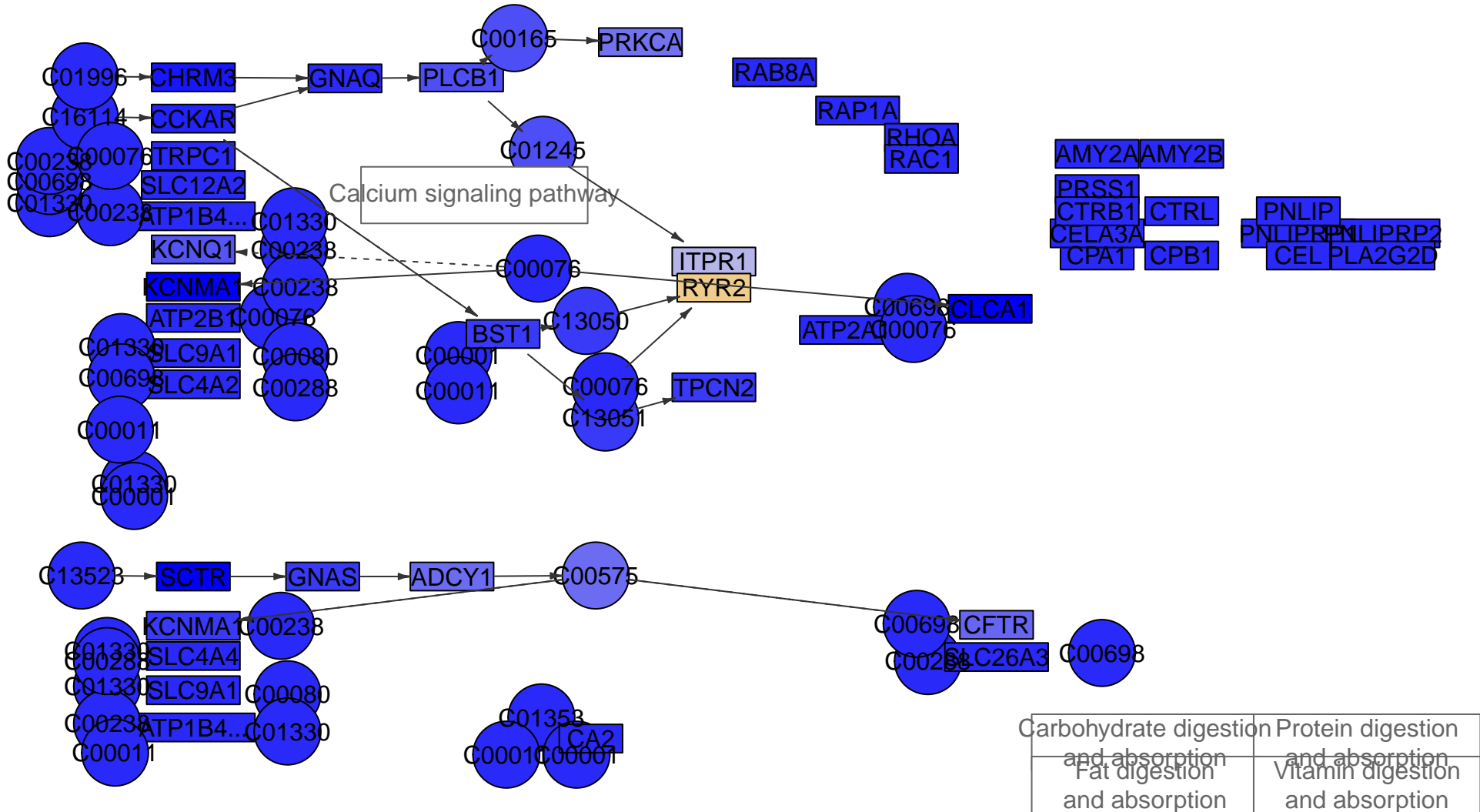

Pancreatic secretion
MPI-250



Tight junction

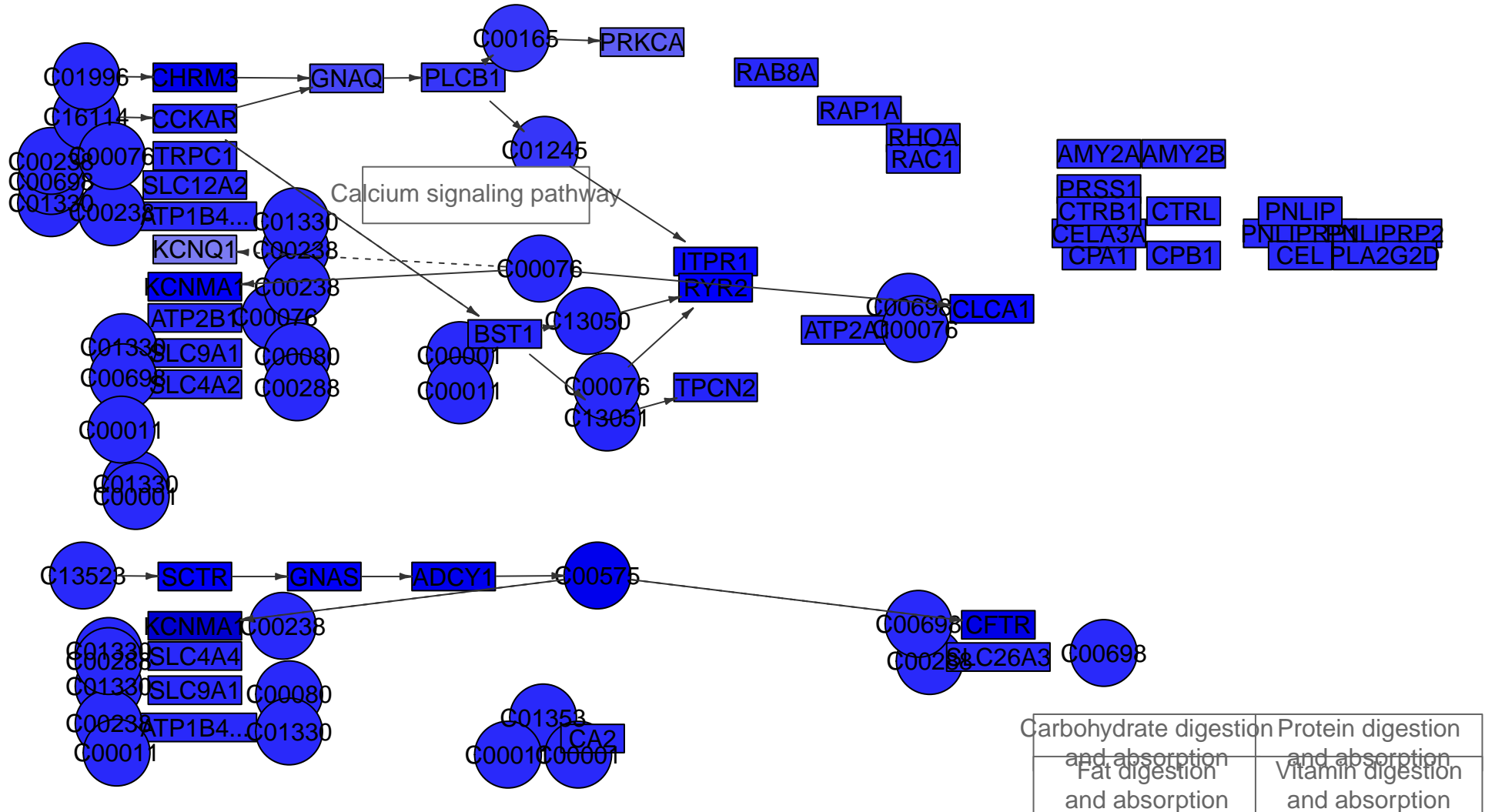

Pancreatic secretion
MPI-008



Tight junction

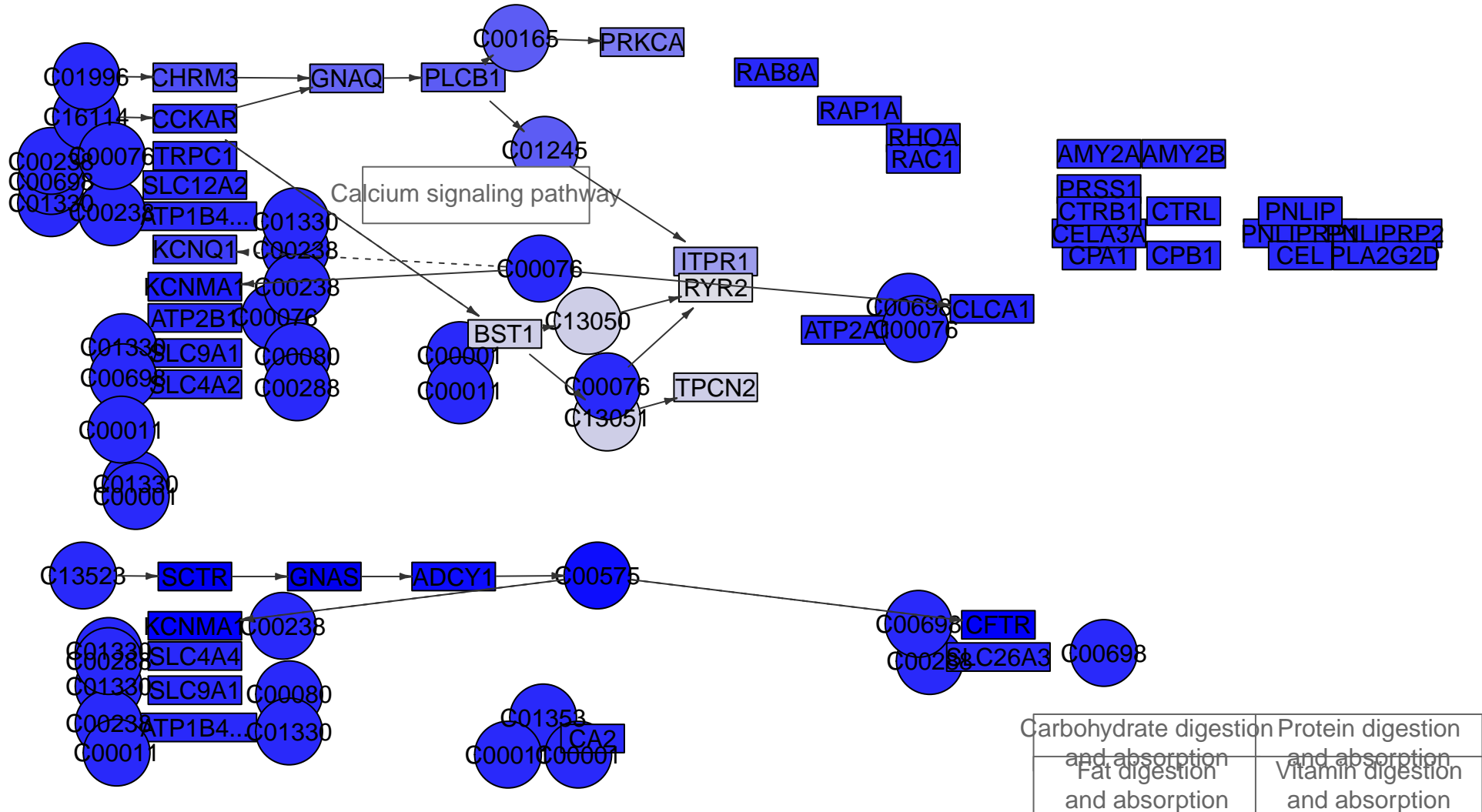

Pancreatic secretion
MPI-009

Tight junction

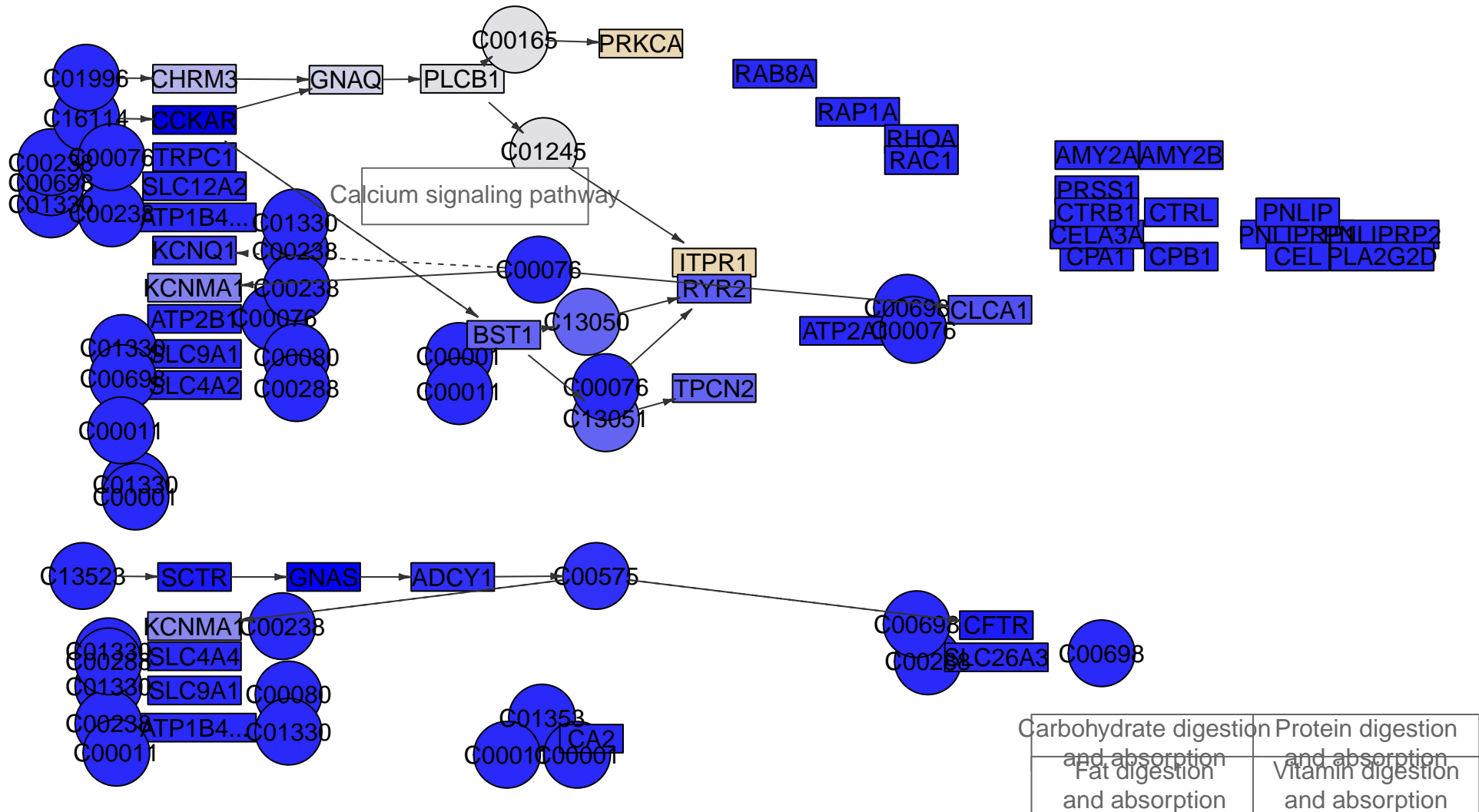

Pancreatic secretion
MPI-010



Tight junction

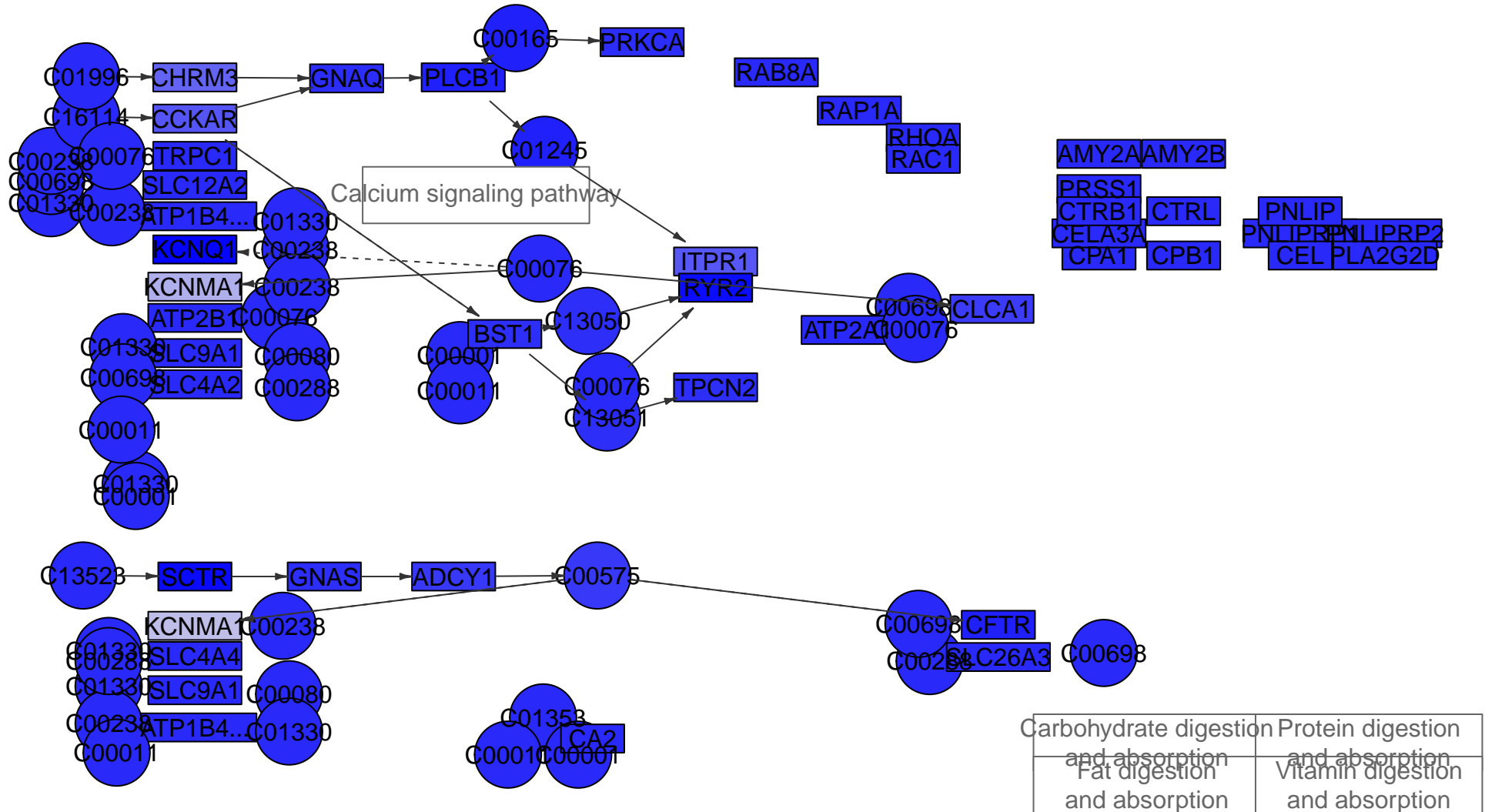

Pancreatic secretion
MPI-012



Tight junction

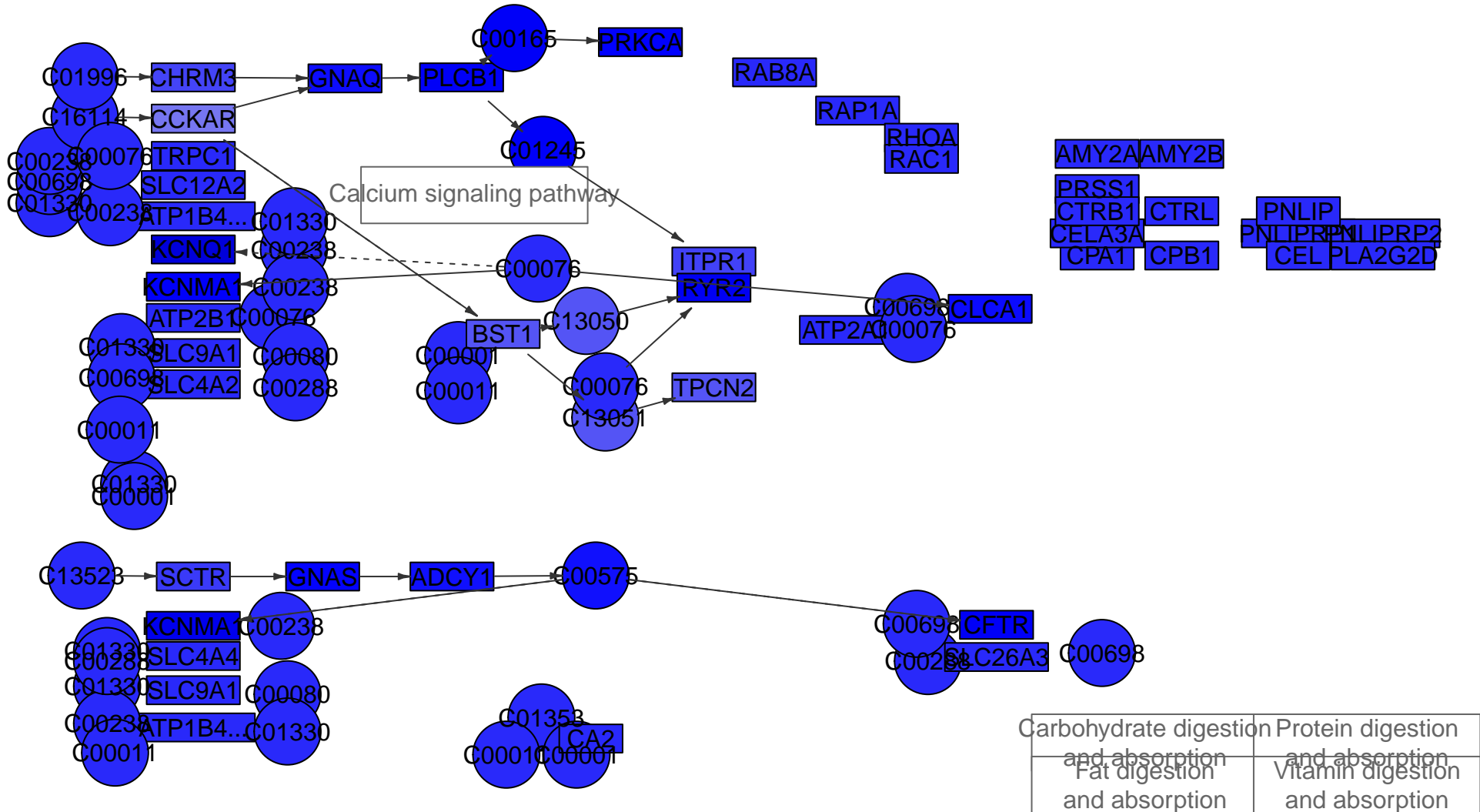

Pancreatic secretion
MPI-013



Tight junction

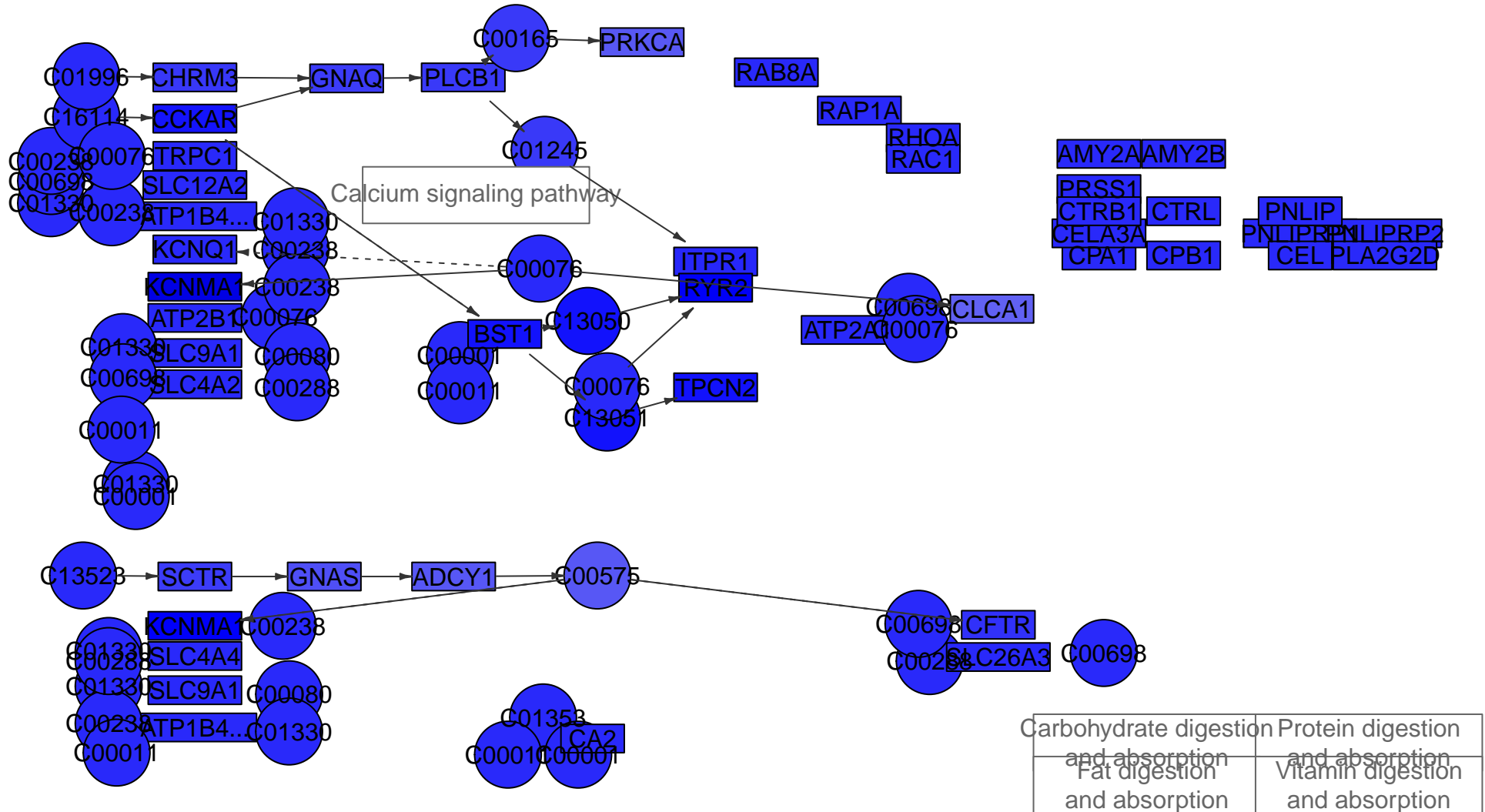

Pancreatic secretion
MPI-014



Tight junction

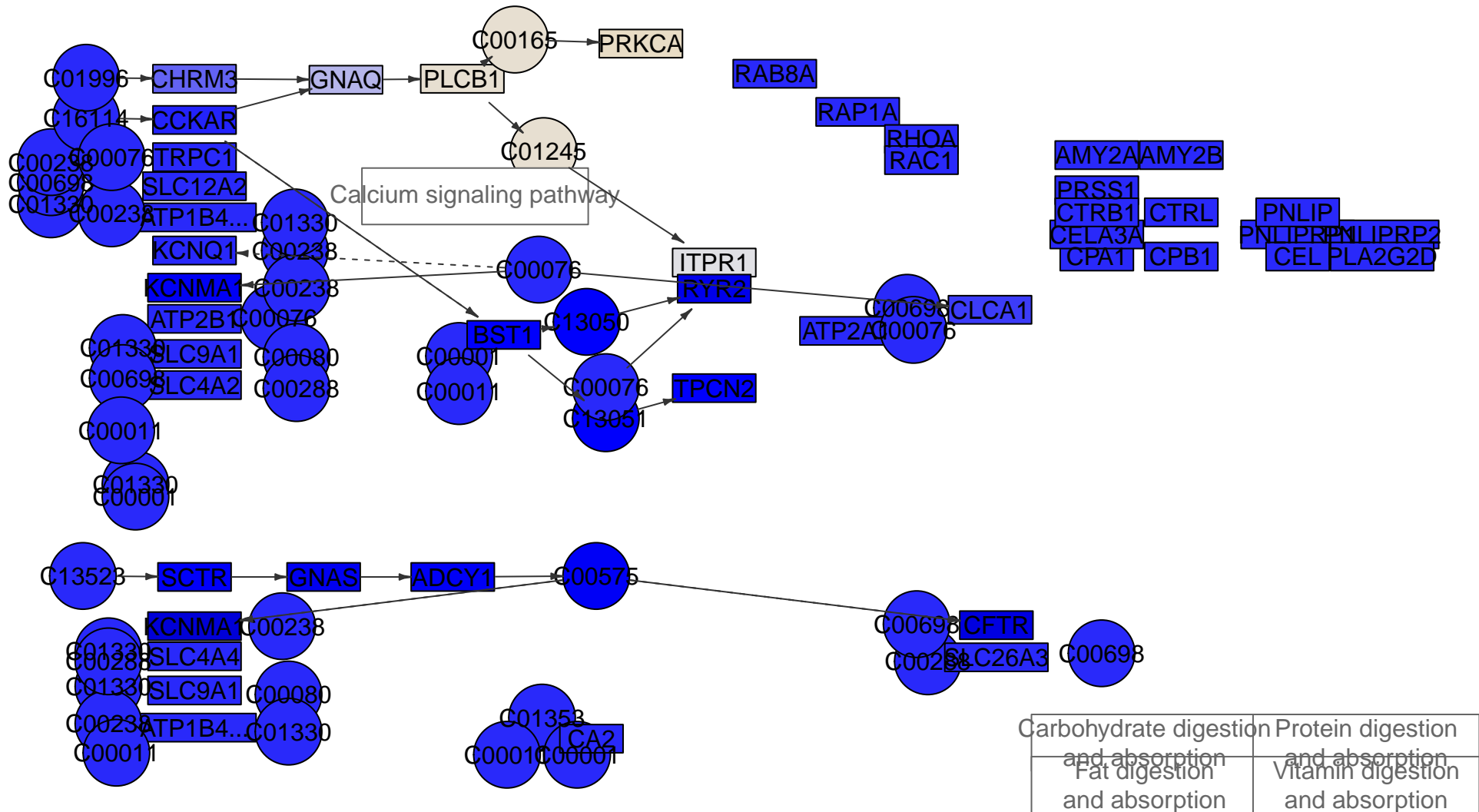

Pancreatic secretion
MPI-015



Tight junction

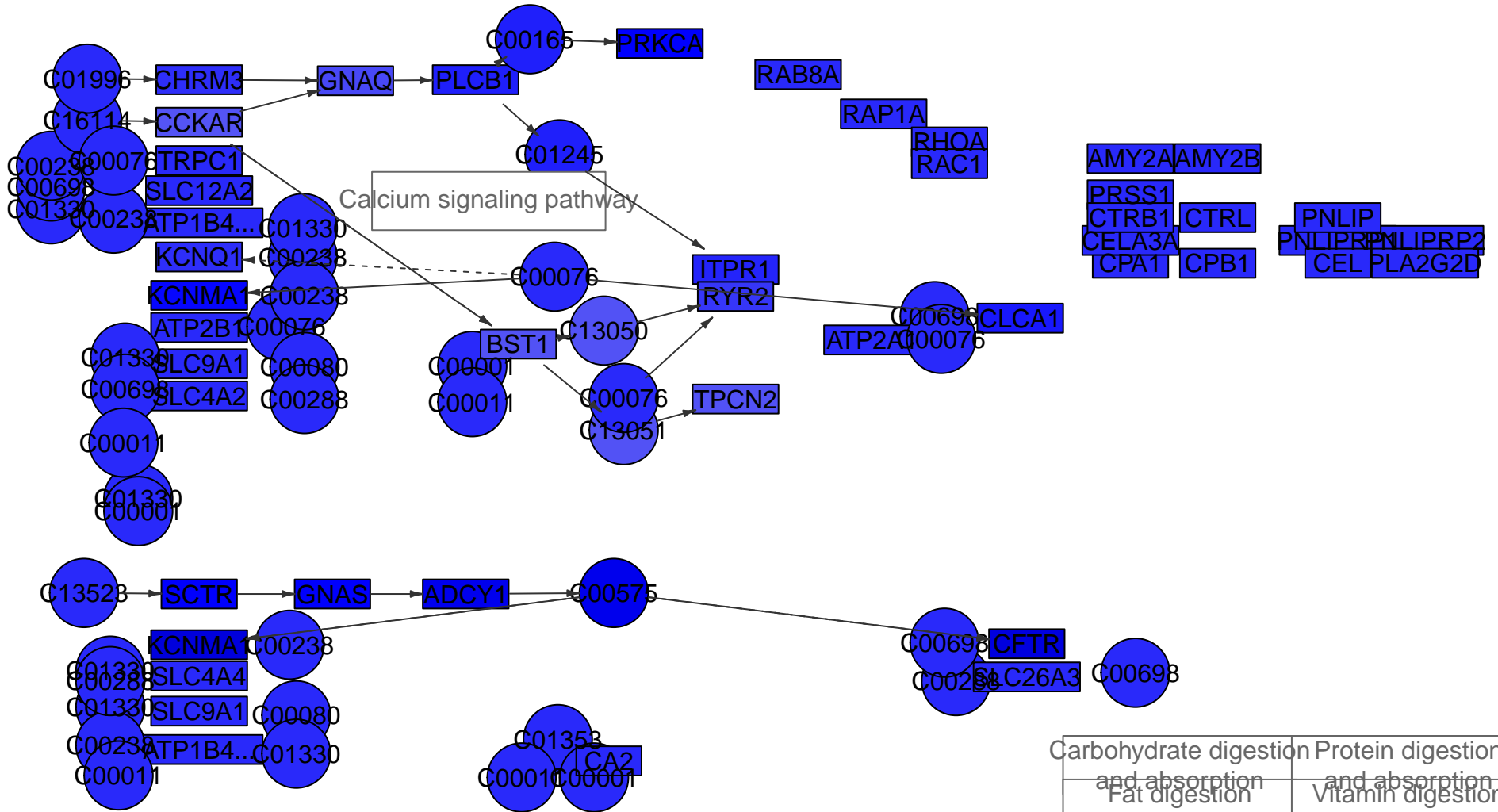

Pancreatic secretion
MPI-021



Tight junction

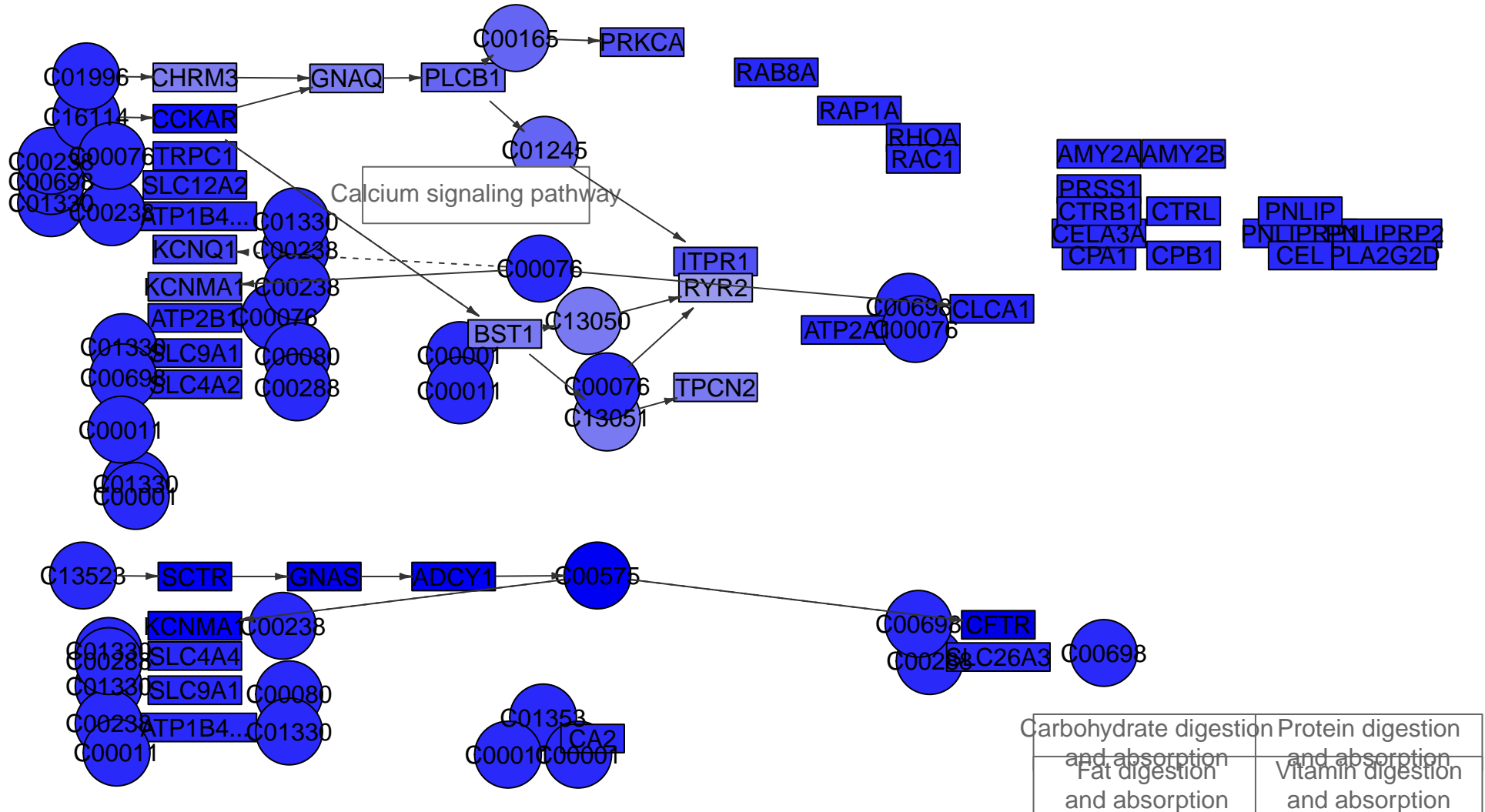

Pancreatic secretion
MPI-022



Tight junction

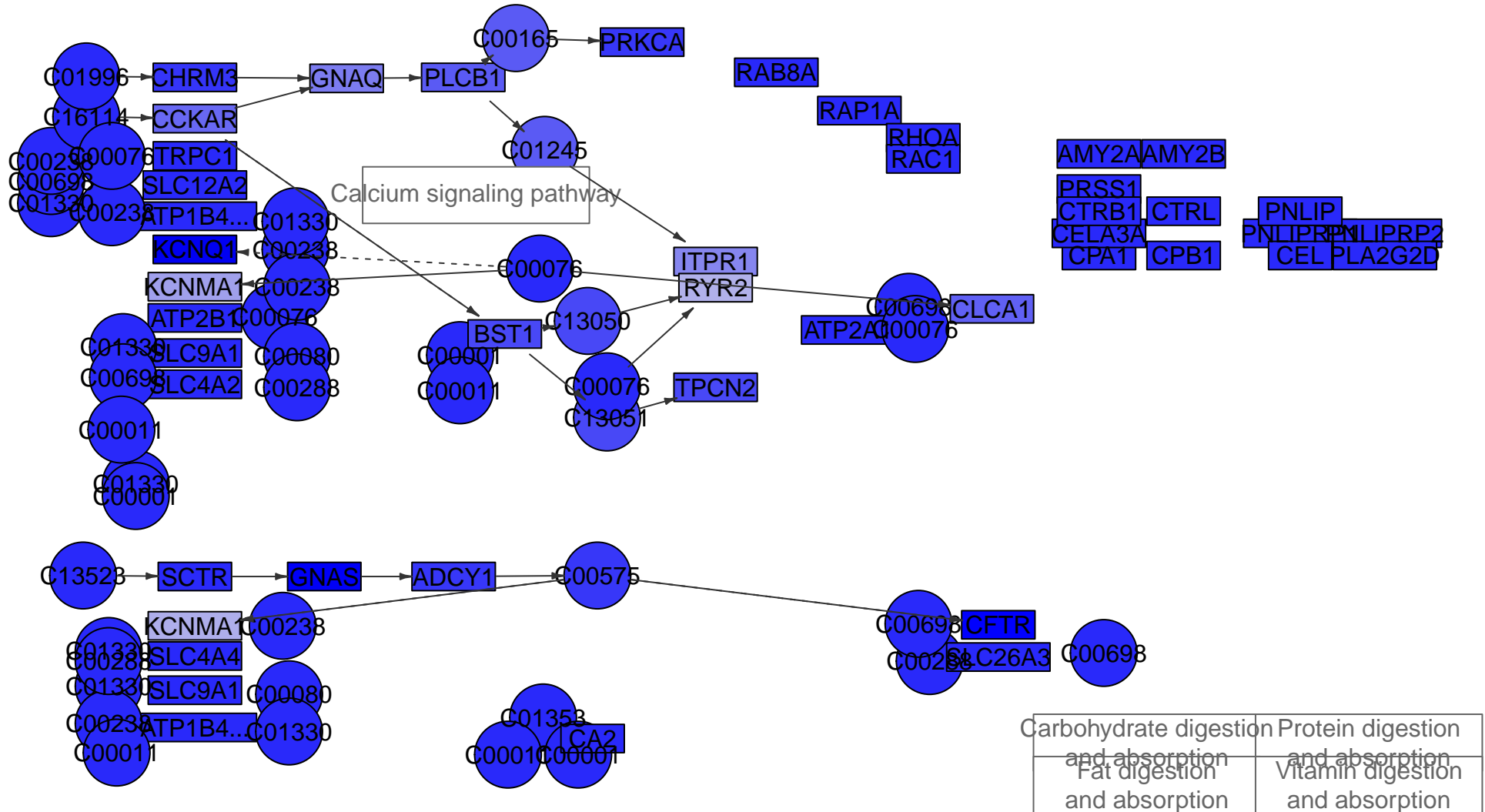

Pancreatic secretion
MPI-025

Tight junction

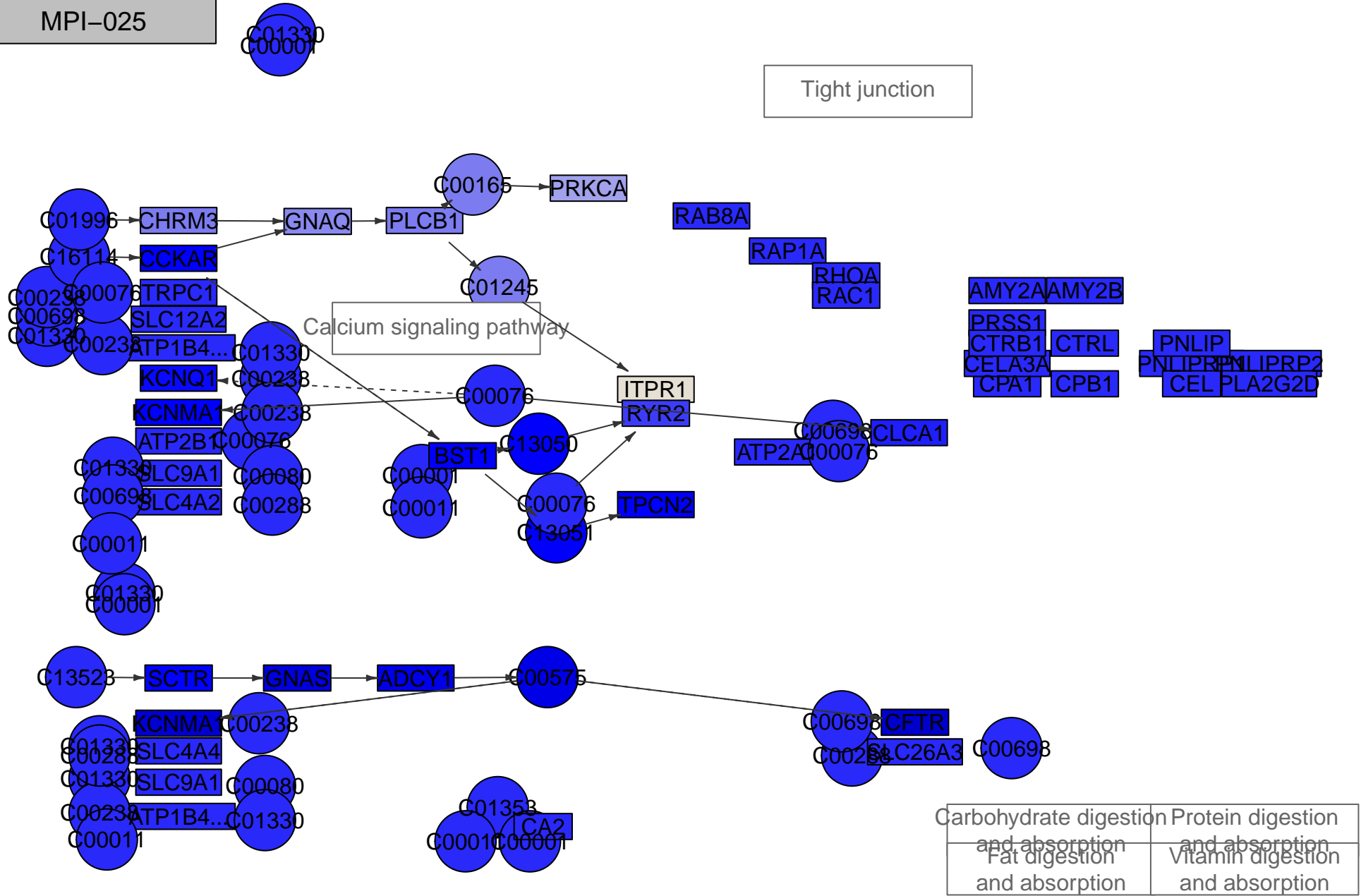

Pancreatic secretion
MPI-029

Tight junction

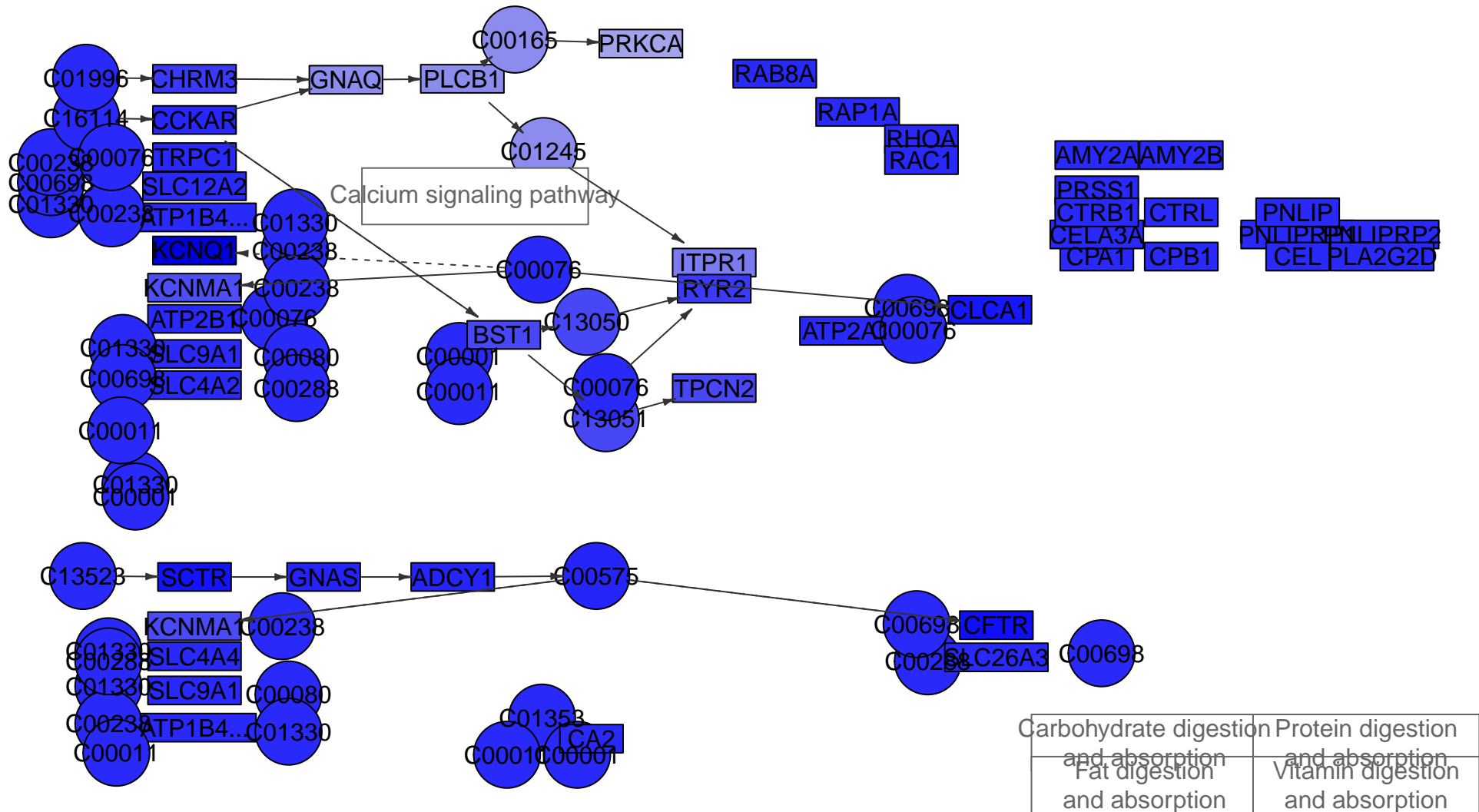

Pancreatic secretion
MPI-030



Tight junction

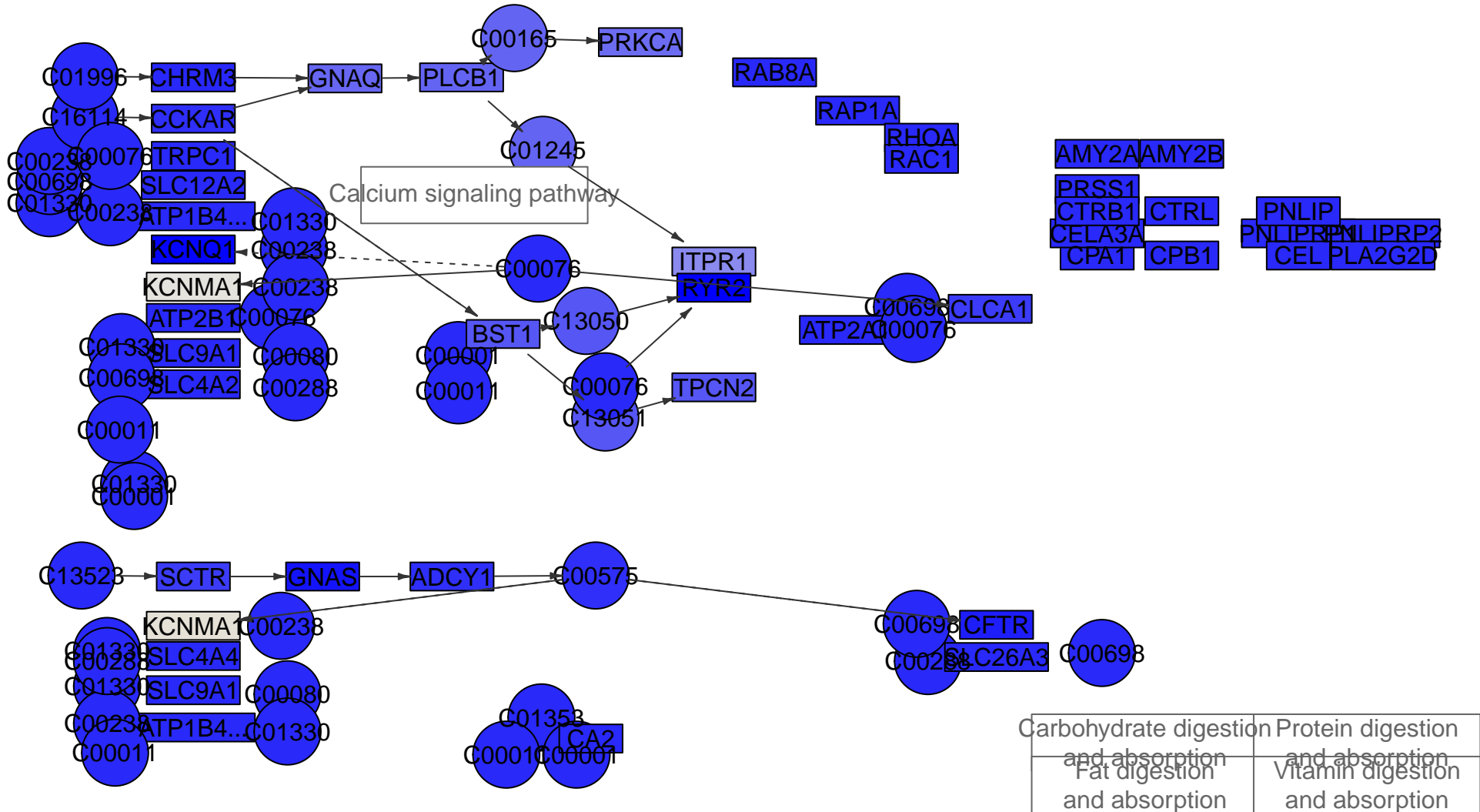

Carbohydrate digestion and absorption	Protein digestion and absorption
Fat digestion and absorption	Vitamin digestion and absorption

Pancreatic secretion
MPI-031



Tight junction

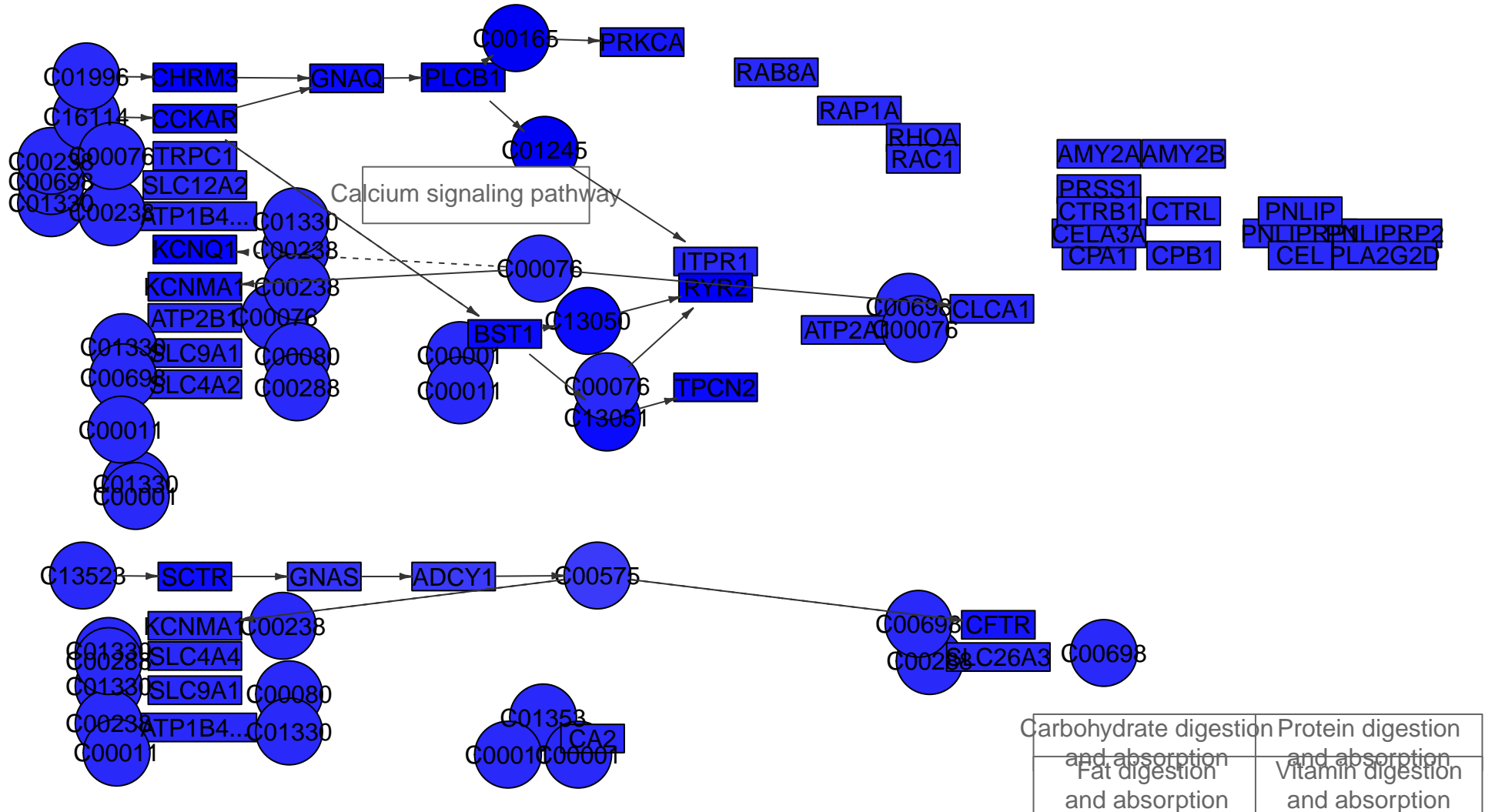

Pancreatic secretion
MPI-039



Tight junction

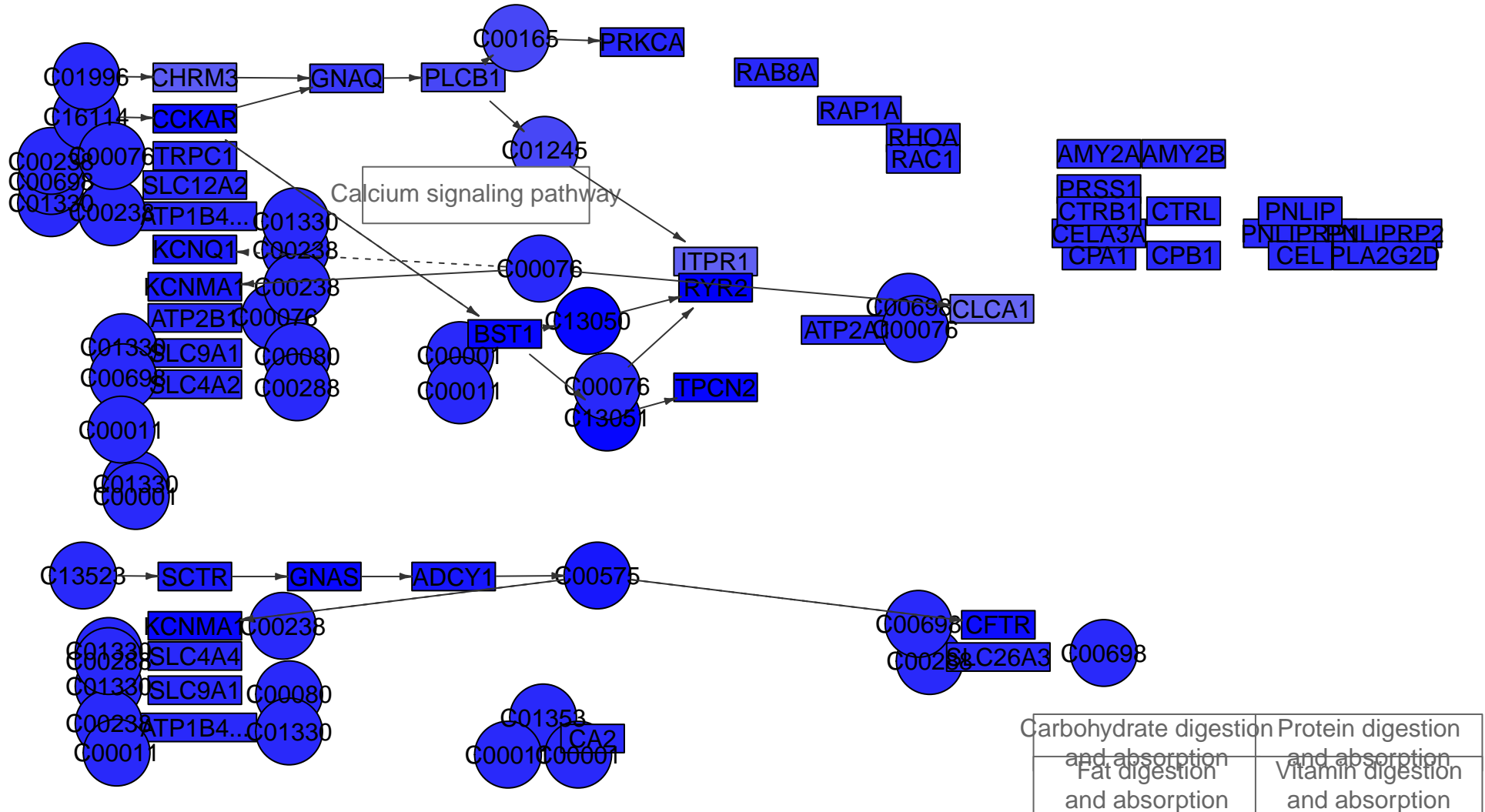

Pancreatic secretion
MPI-040

Tight junction

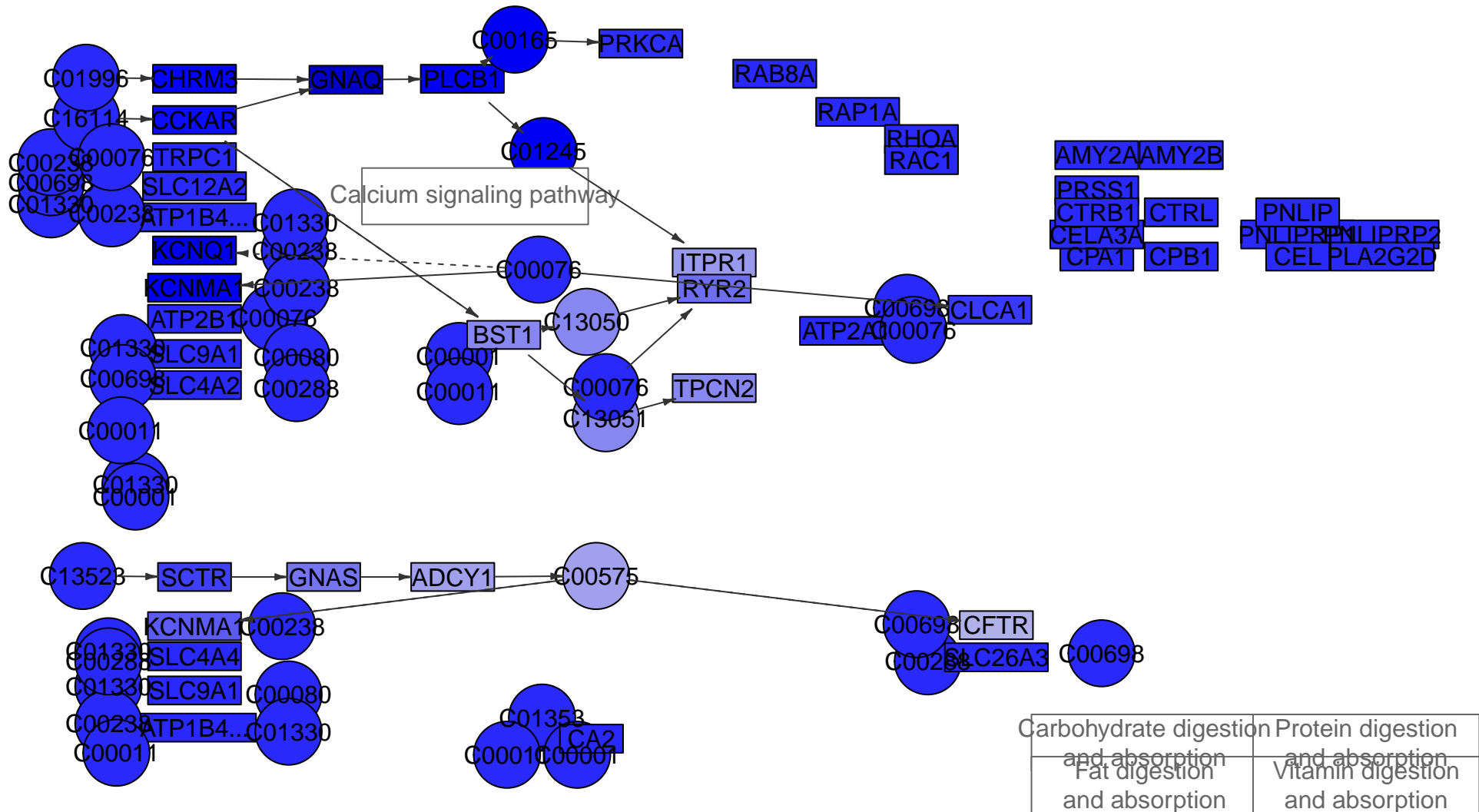

Pancreatic secretion
MPI-047



Tight junction

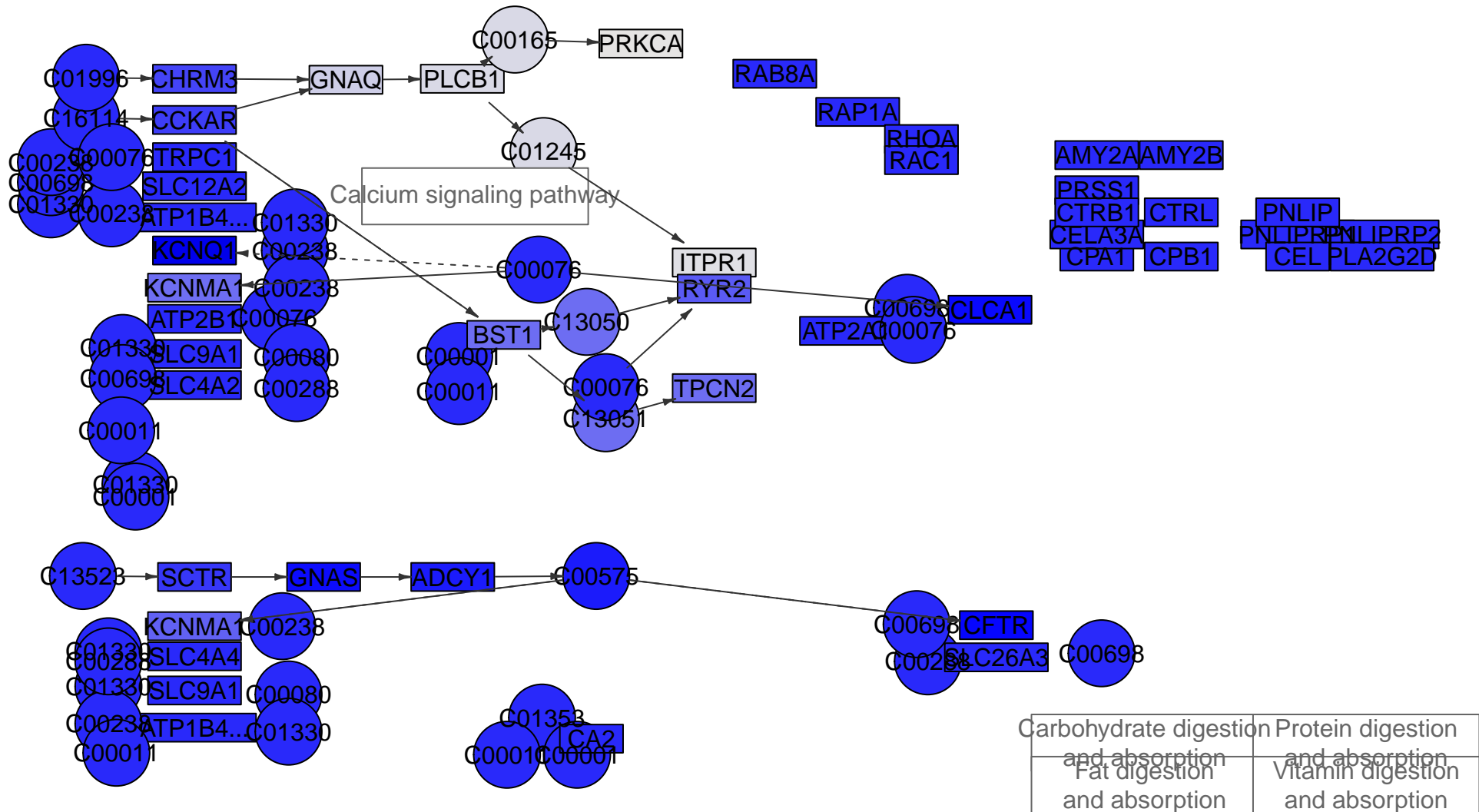

Pancreatic secretion
MPI-053

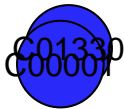

Tight junction

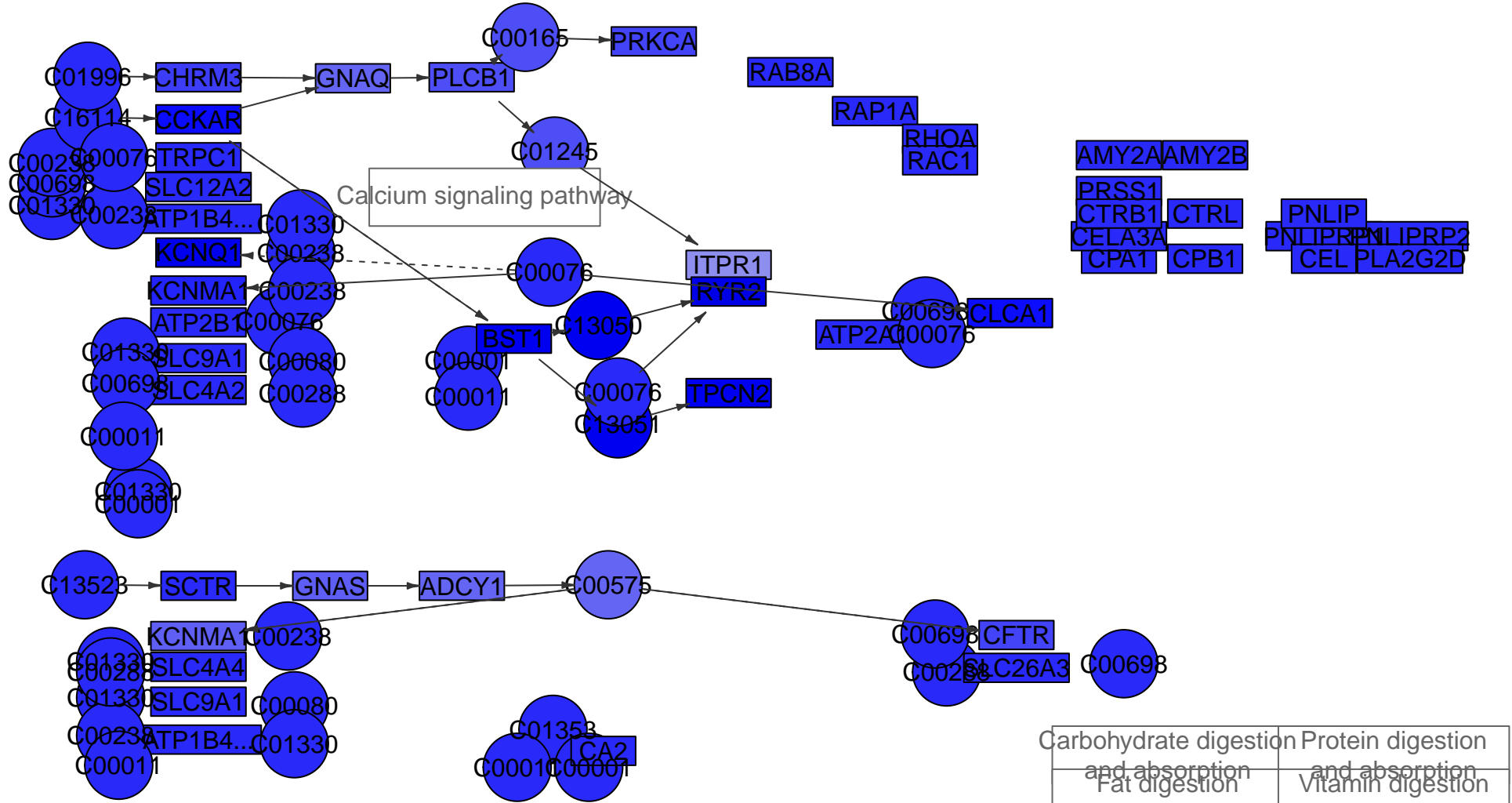

Carbohydrate digestion and absorption	Protein digestion and absorption
Fat digestion and absorption	Vitamin digestion and absorption

Pancreatic secretion
MPI-062



Tight junction

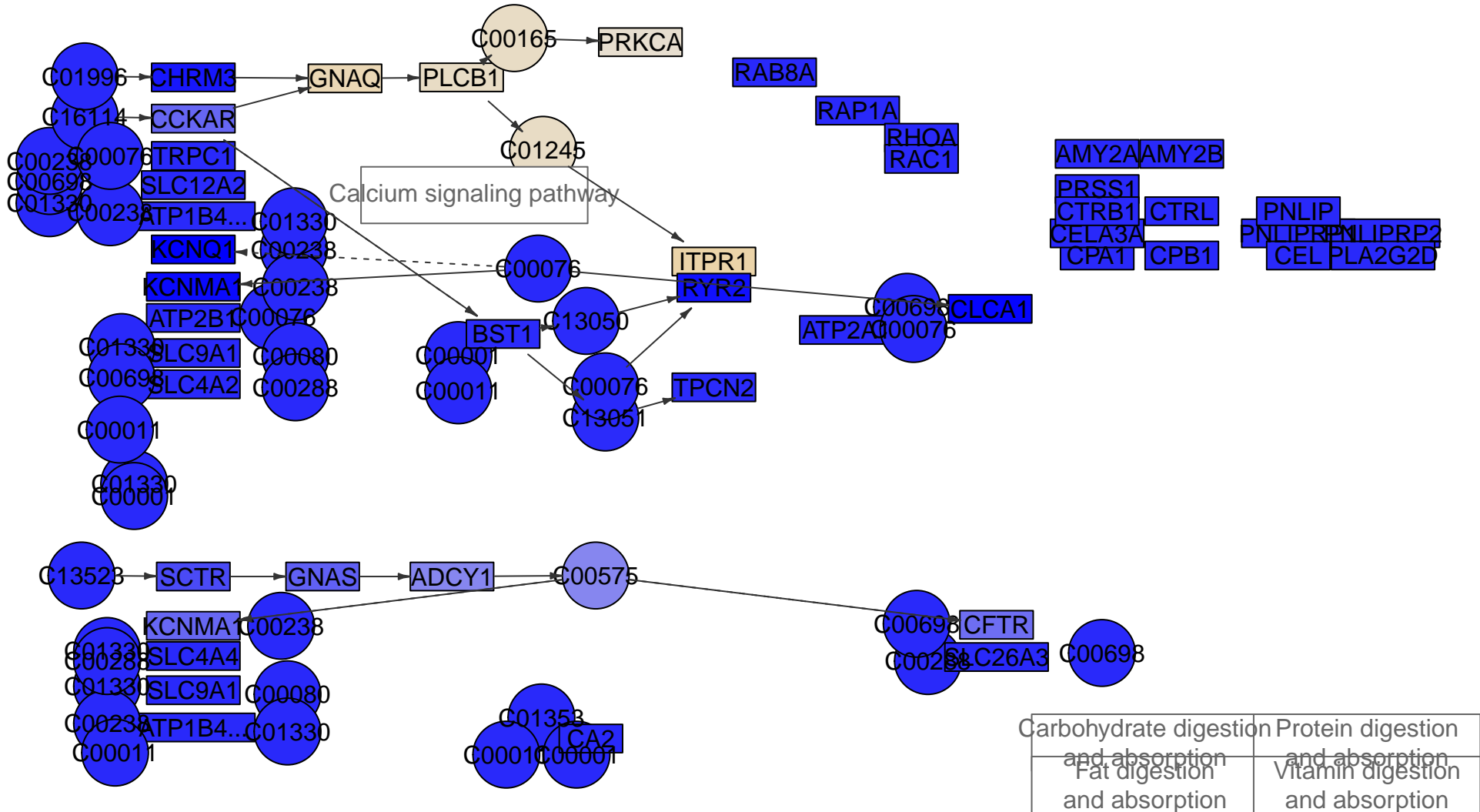

Pancreatic secretion
MPI-063



Tight junction

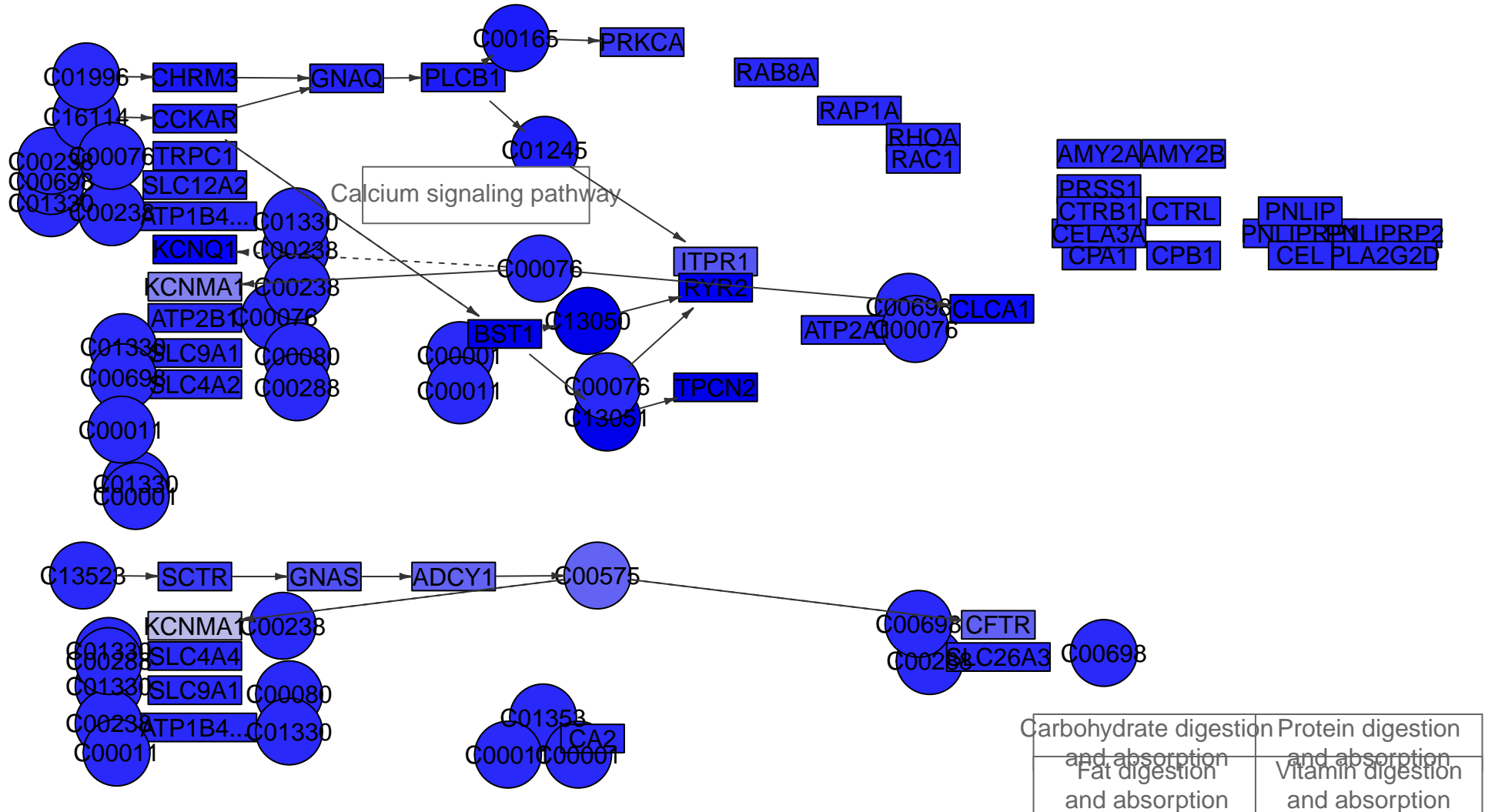

Carbohydrate digestion and absorption	Protein digestion and absorption
Fat digestion and absorption	Vitamin digestion and absorption

Pancreatic secretion
MPI-069



Tight junction

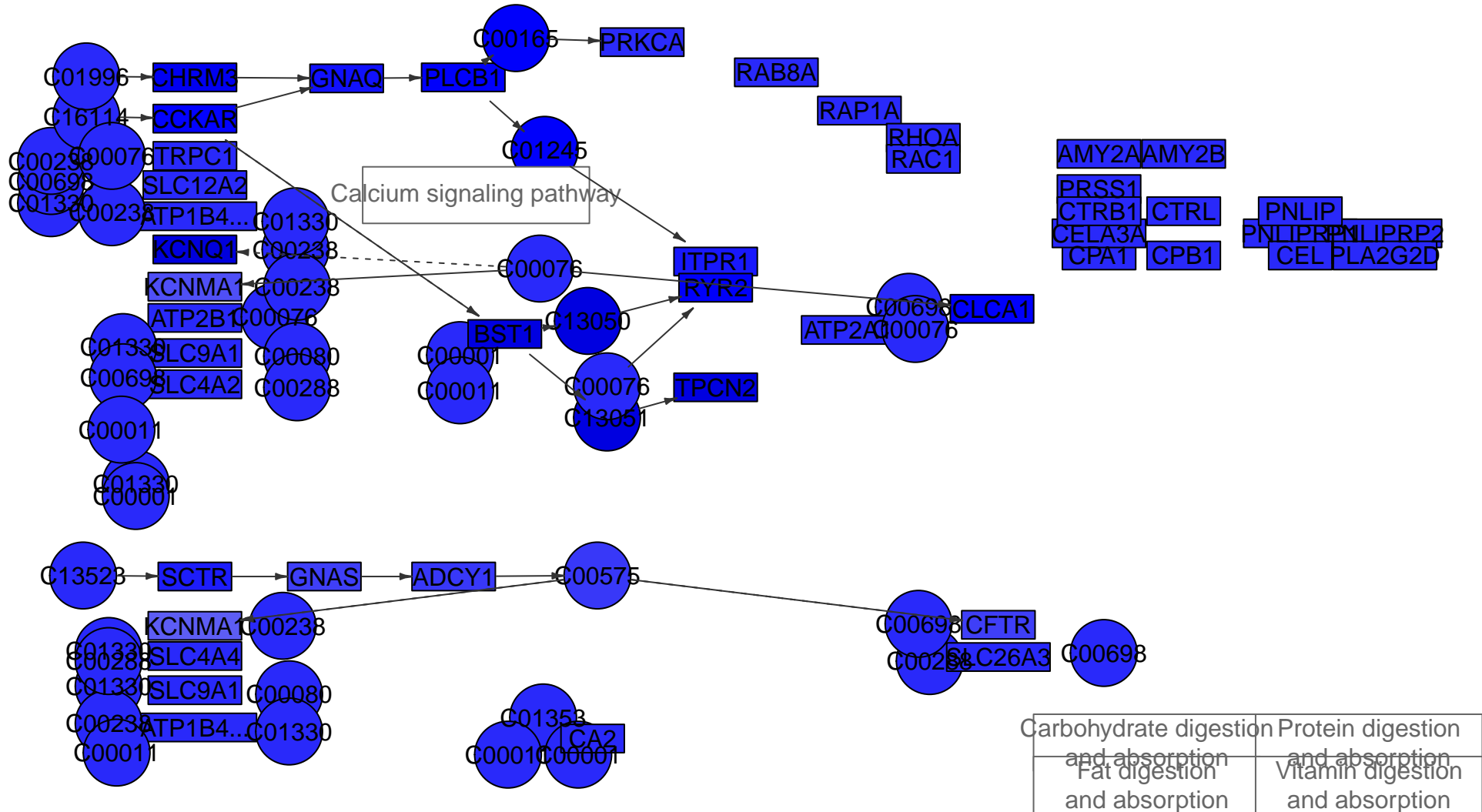

Pancreatic secretion
MPI-076



Tight junction

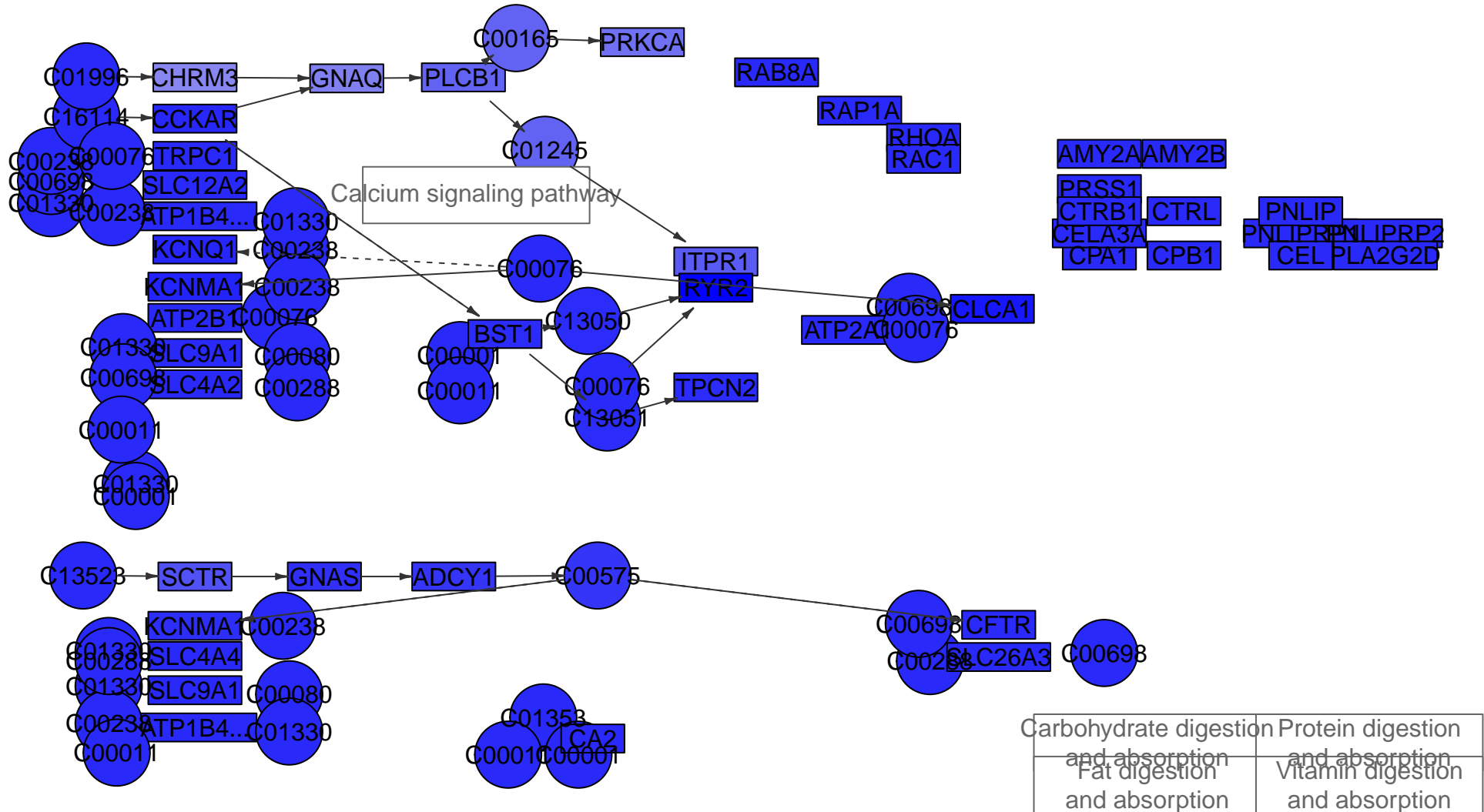

Pancreatic secretion
MPI-083



Tight junction

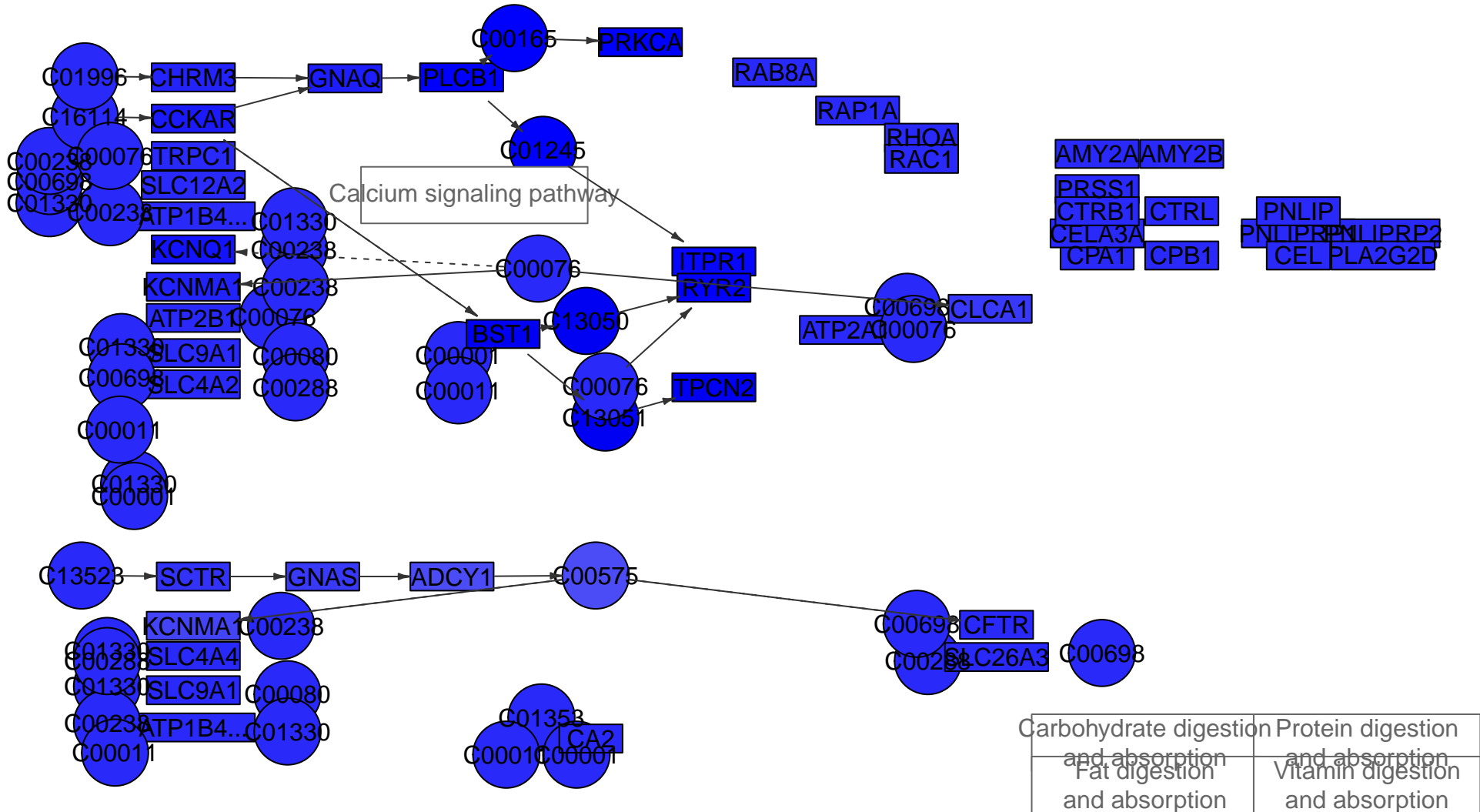

Pancreatic secretion
MPI-088



Tight junction

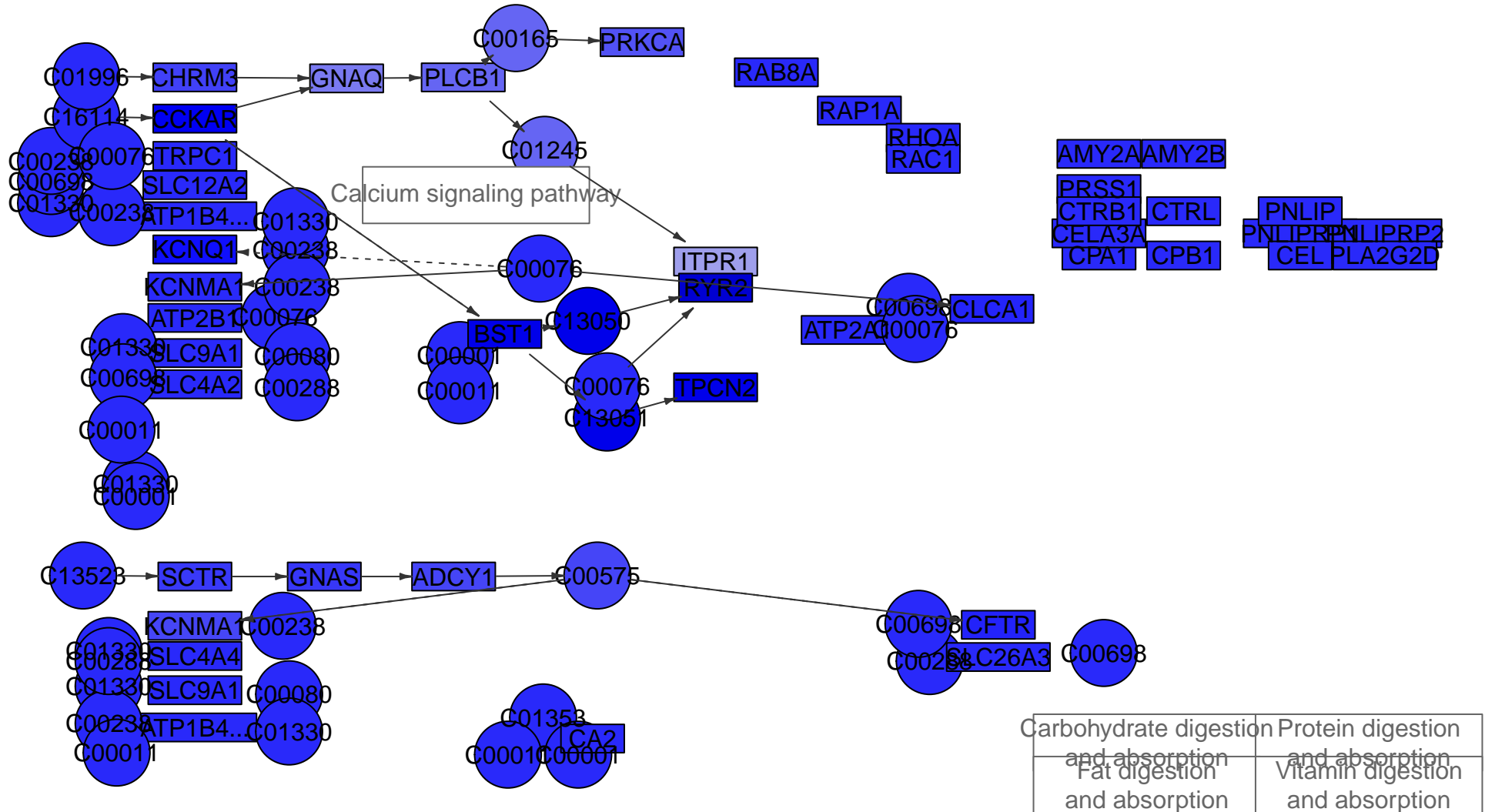

Pancreatic secretion
MPI-096



Tight junction

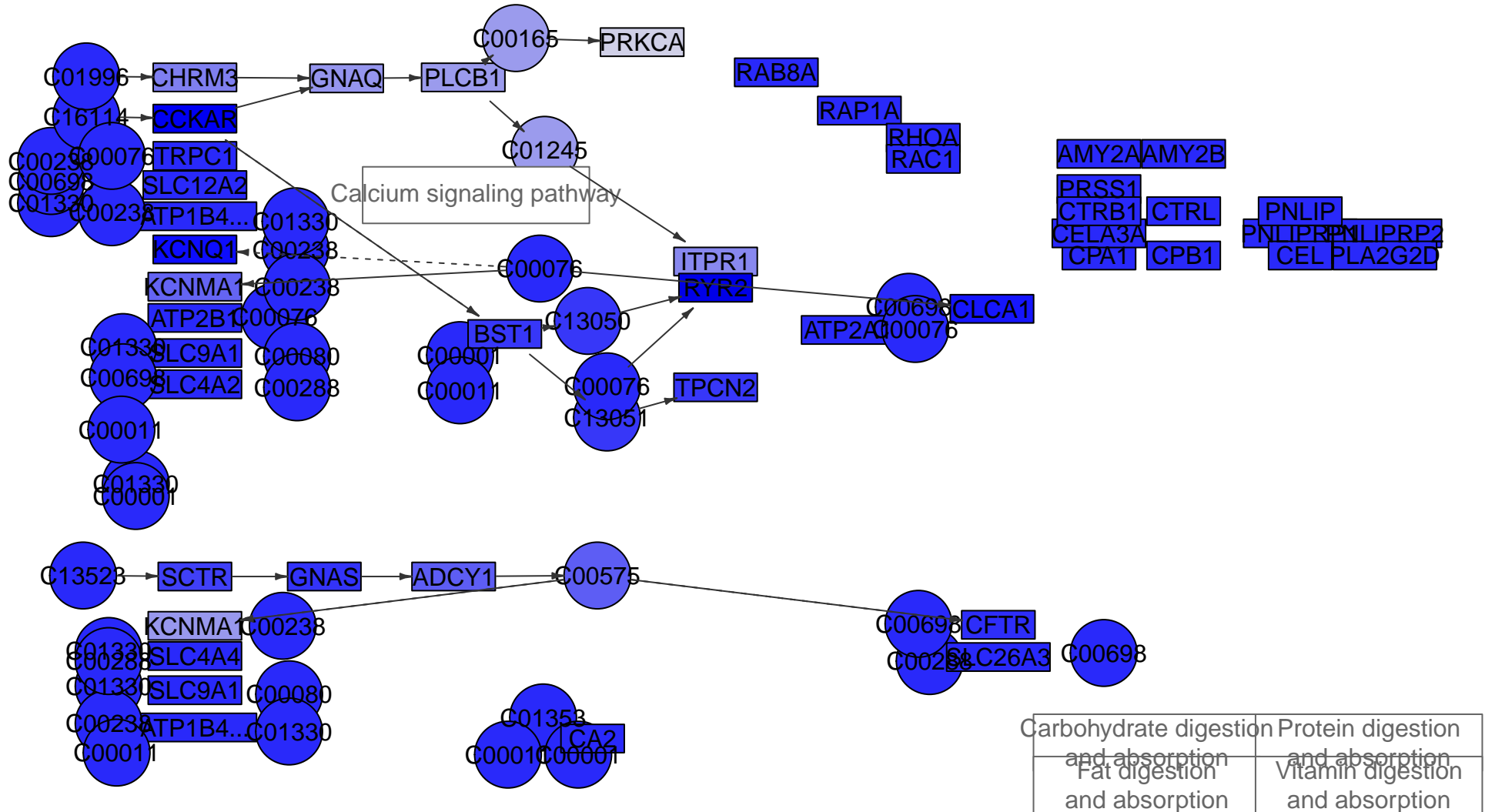

Pancreatic secretion
MPI-098



Tight junction

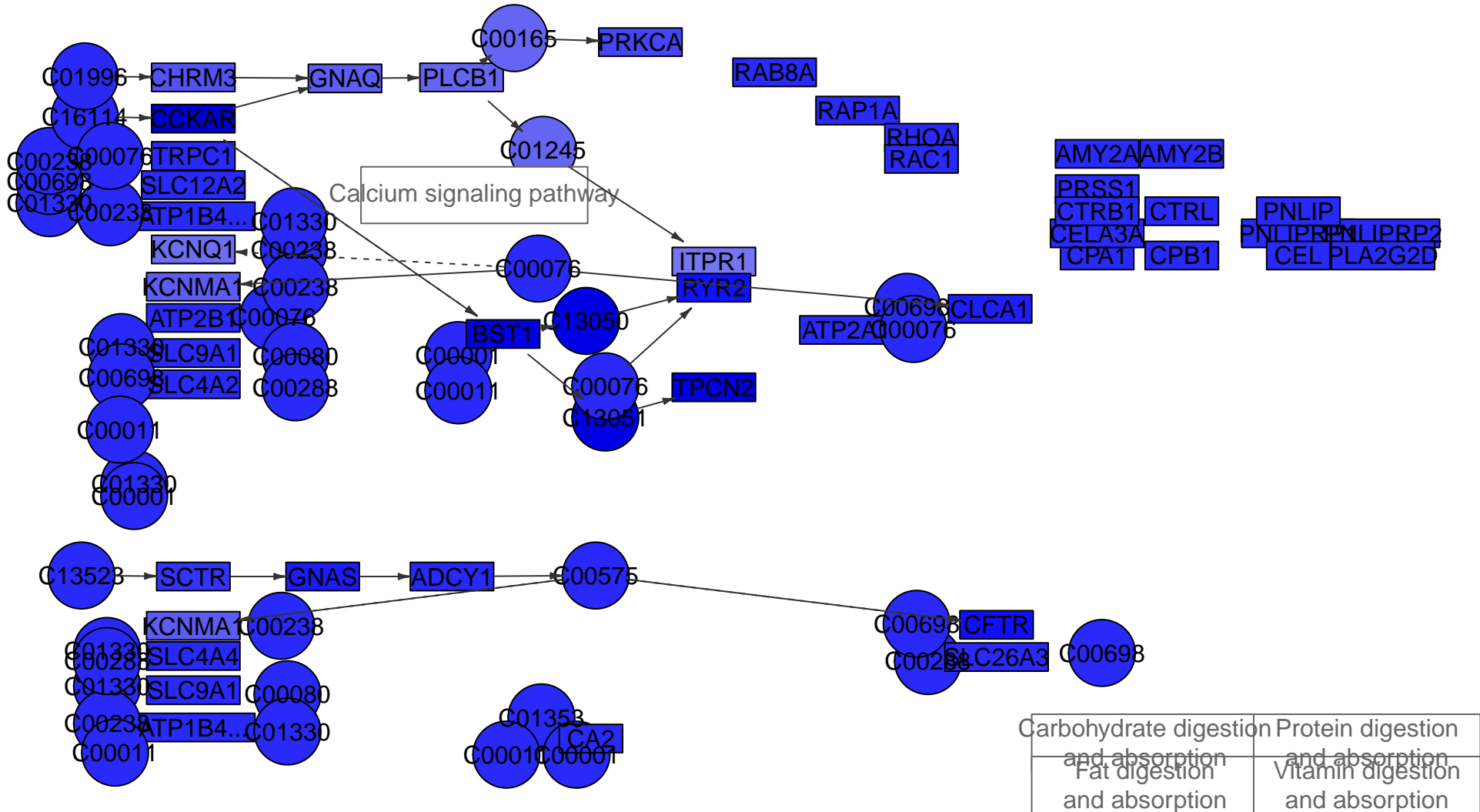

Pancreatic secretion
MPI-100

Tight junction

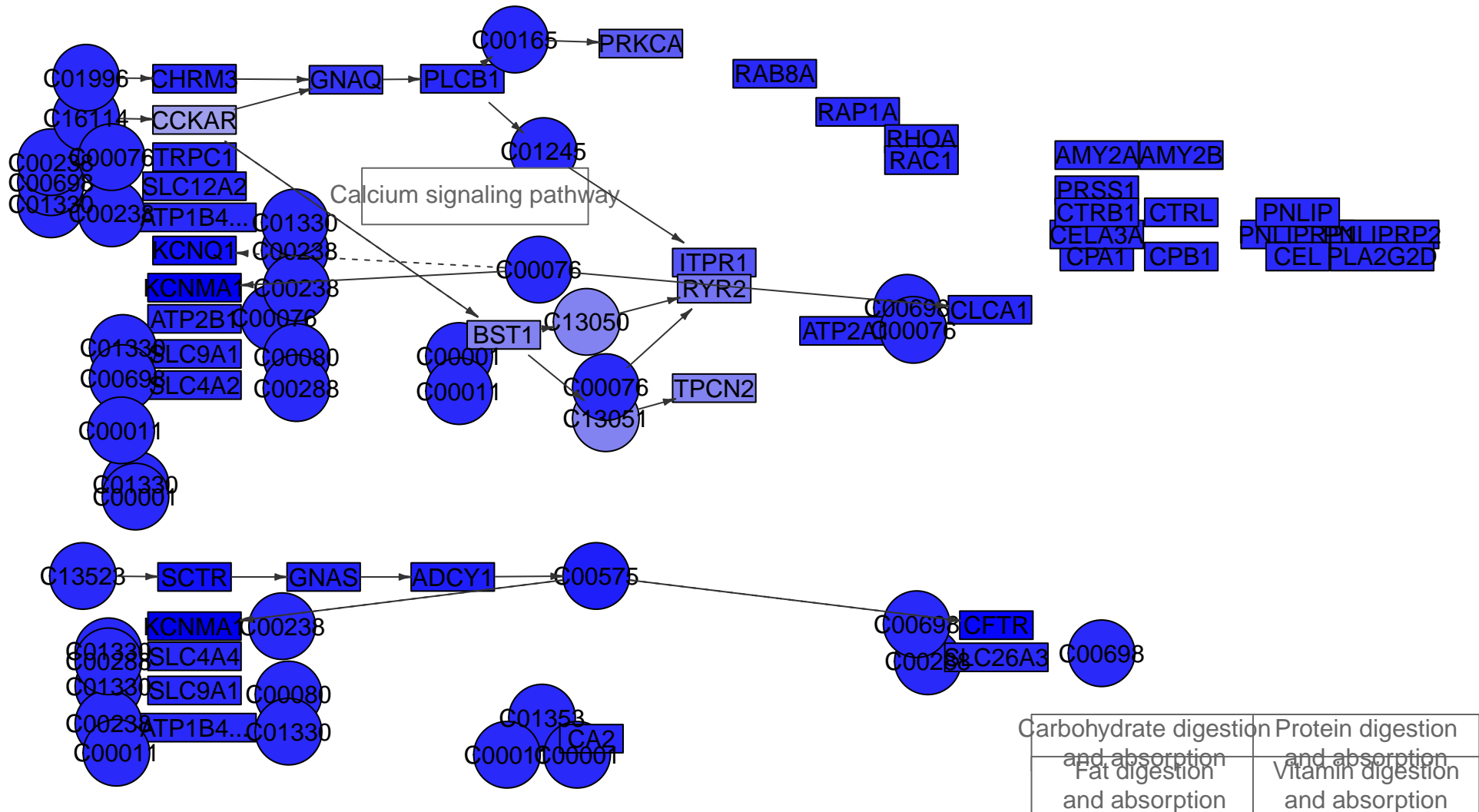

Pancreatic secretion
MPI-105

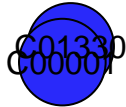

Tight junction

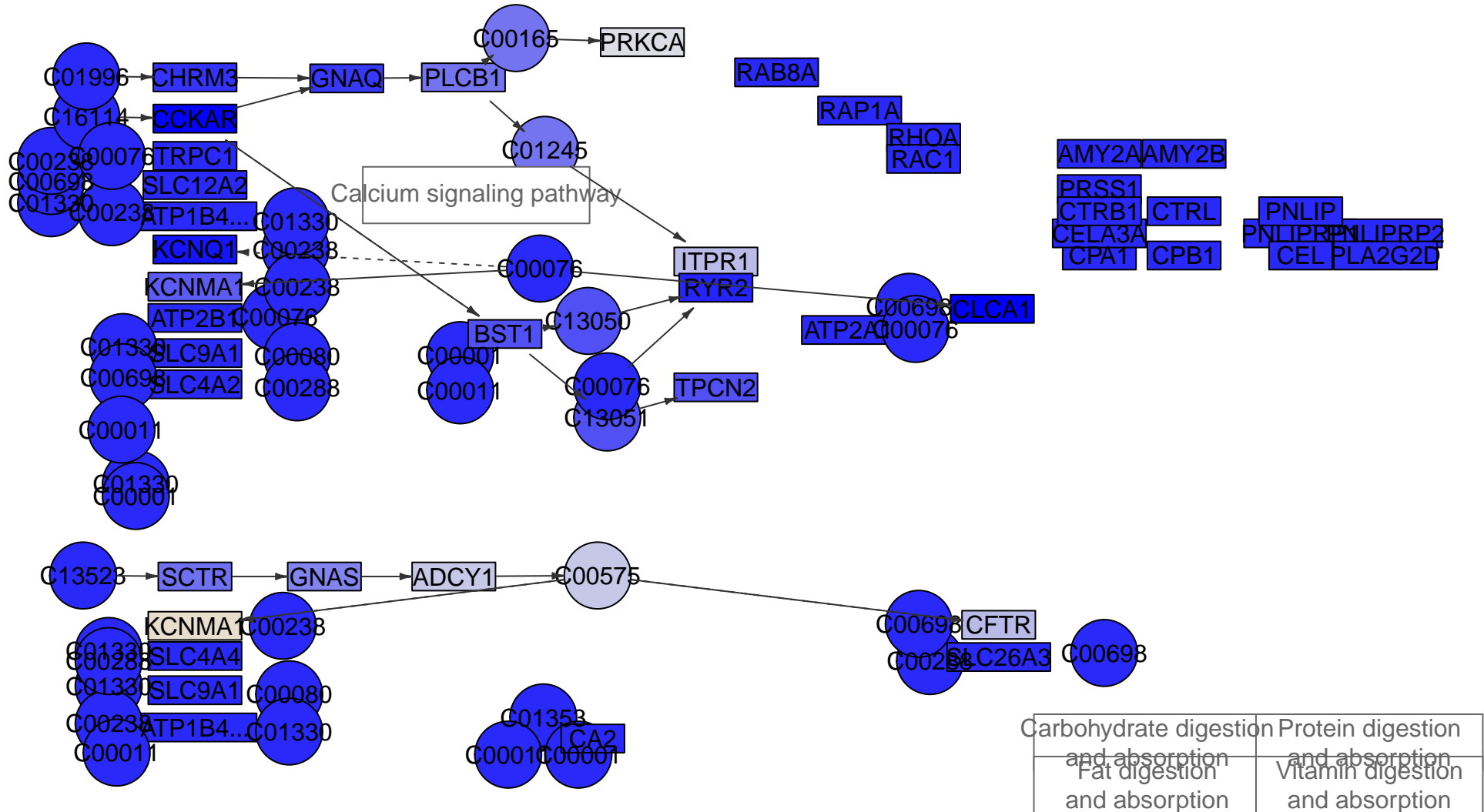

Pancreatic secretion
MPI-106



Tight junction

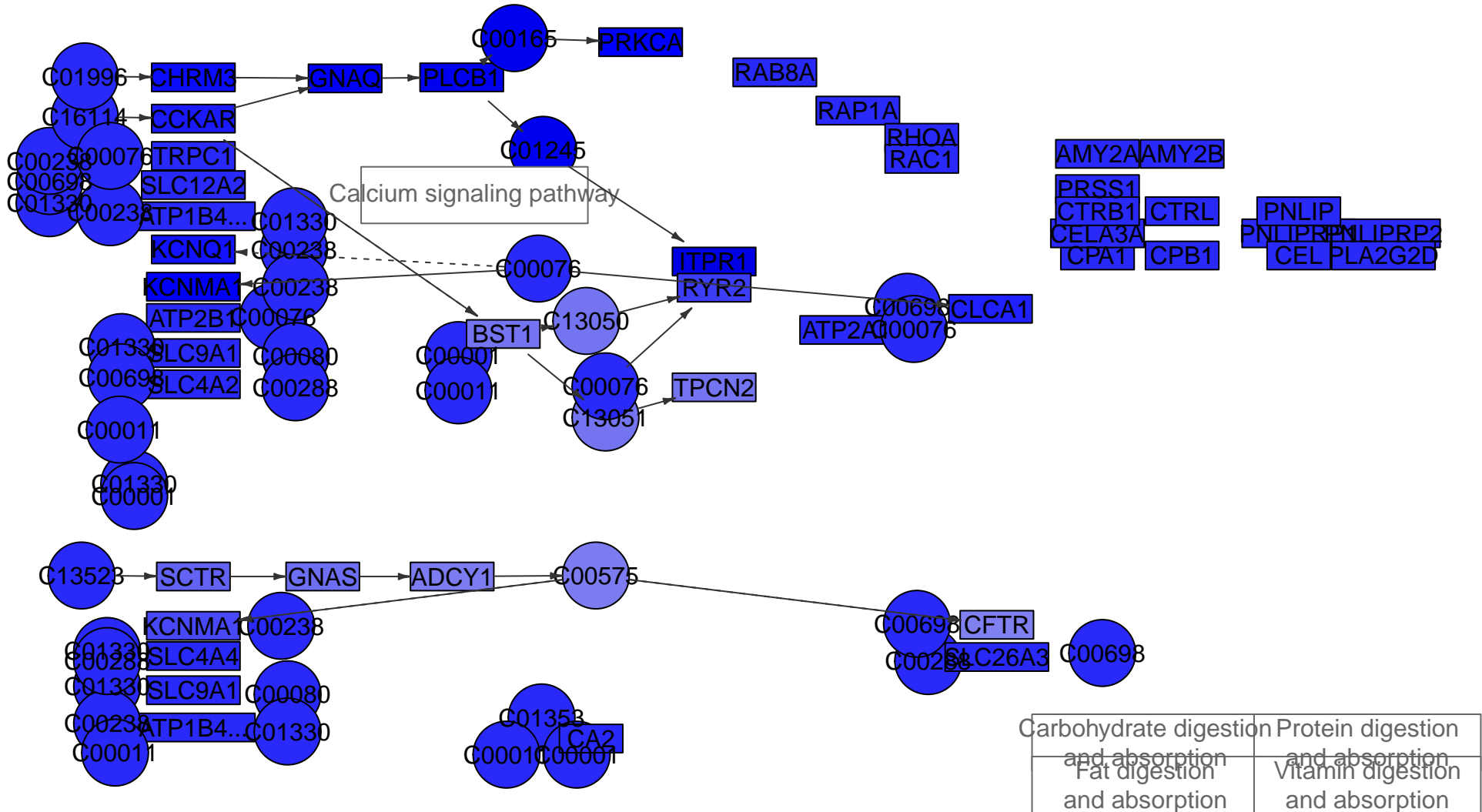

Pancreatic secretion
MPI-108



Tight junction

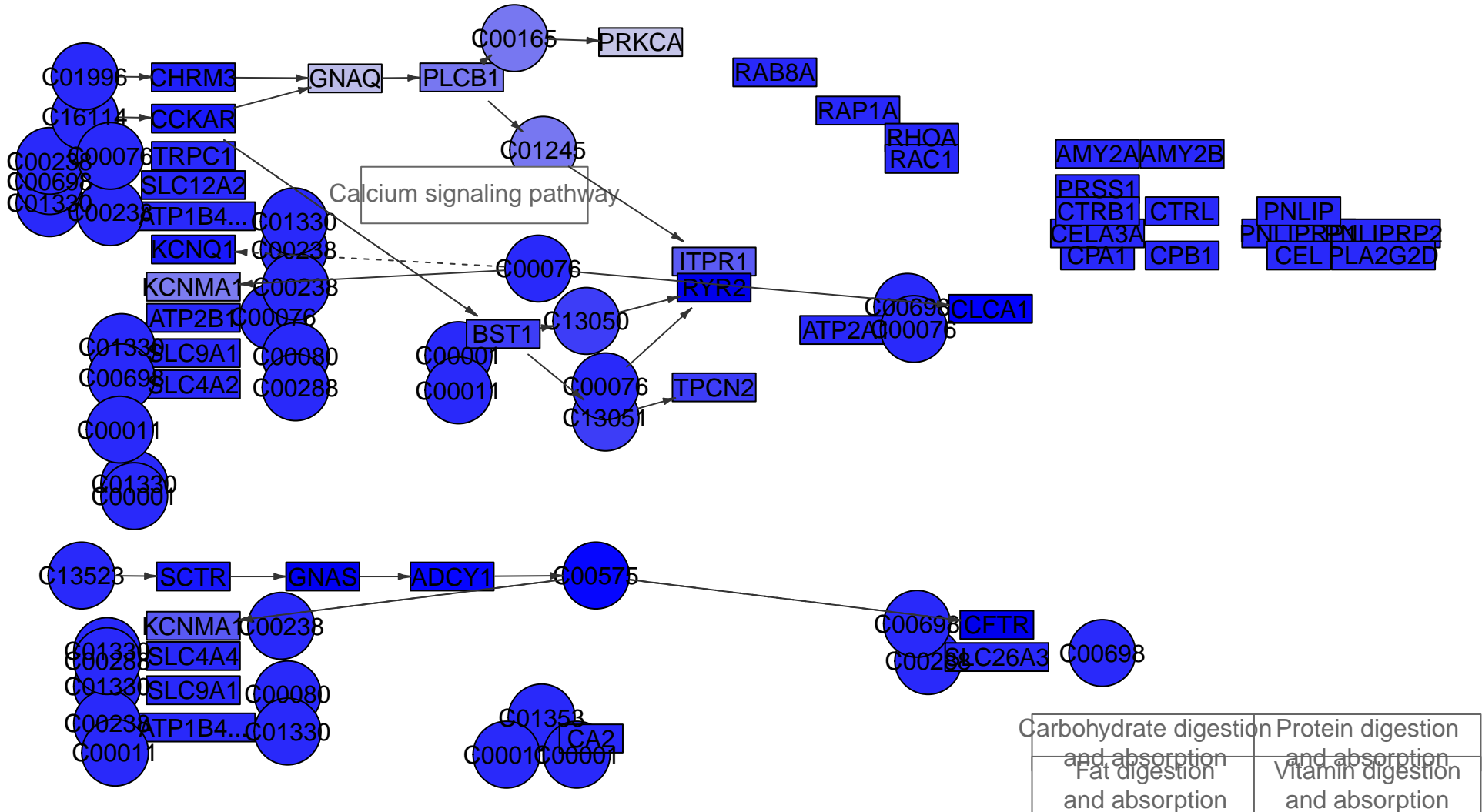

Pancreatic secretion
MPI-109



Tight junction

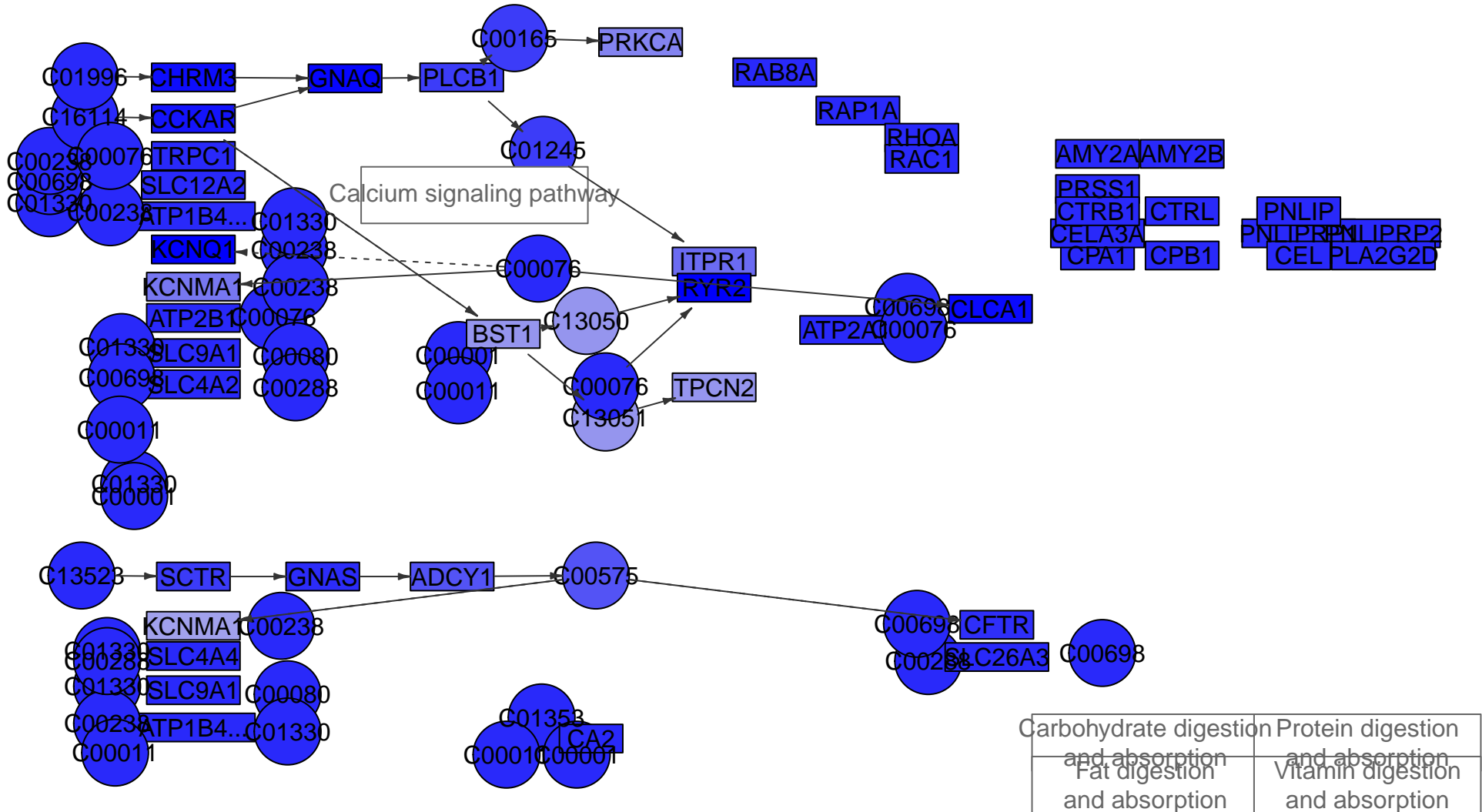

Pancreatic secretion
MPI-110

Tight junction

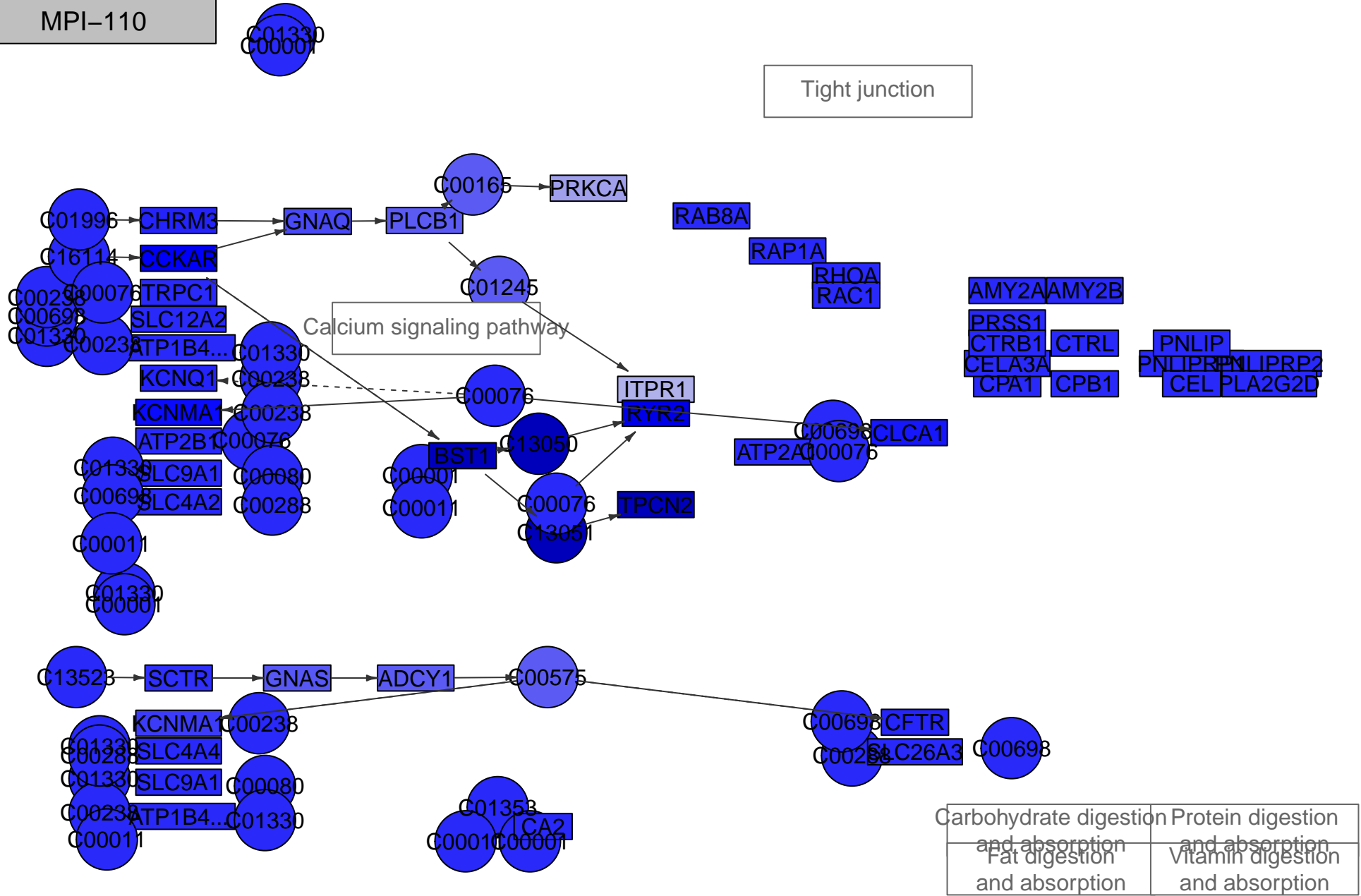

Pancreatic secretion
MPI-111



Tight junction

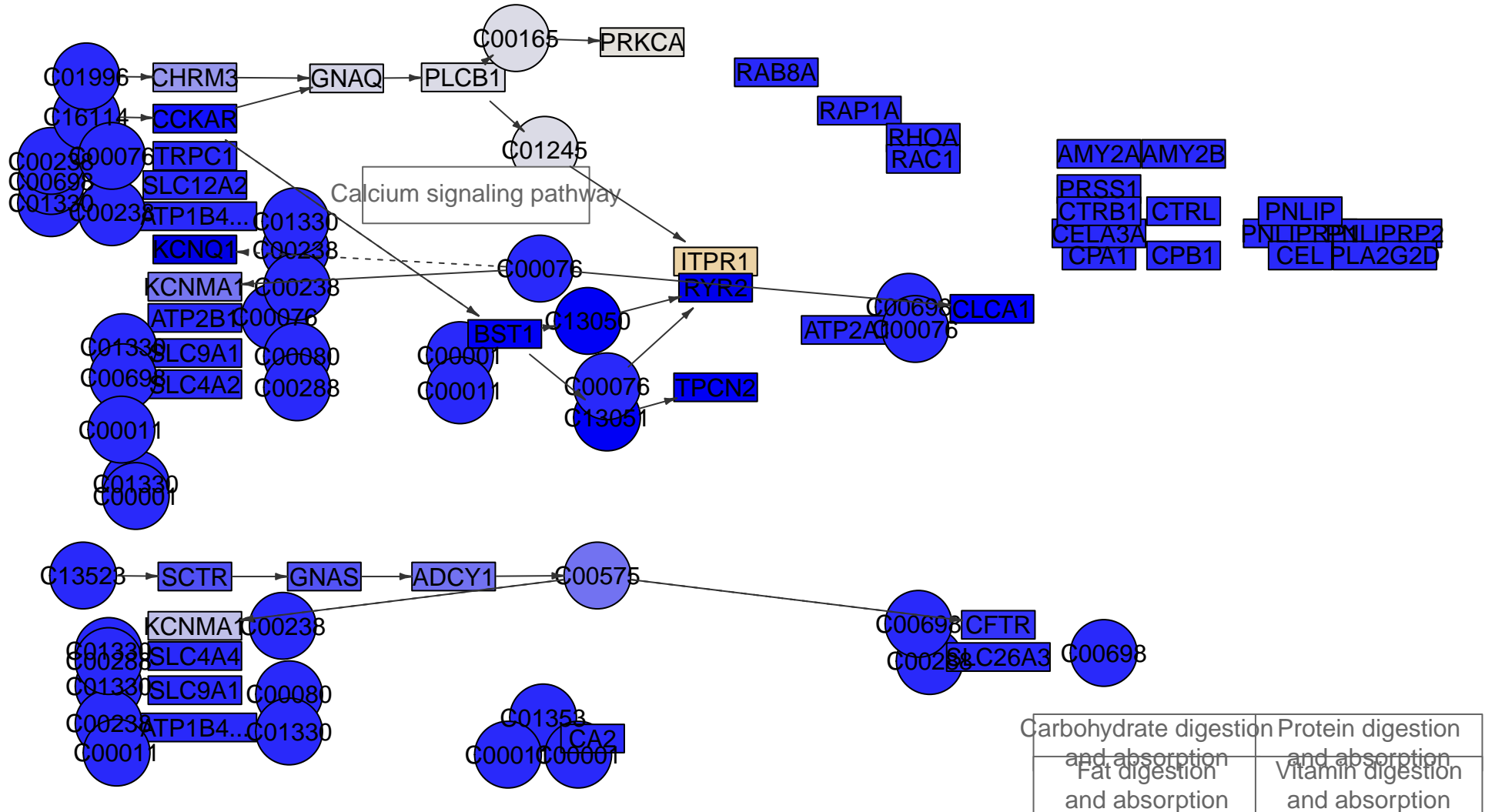

Pancreatic secretion
MPI-113



Tight junction

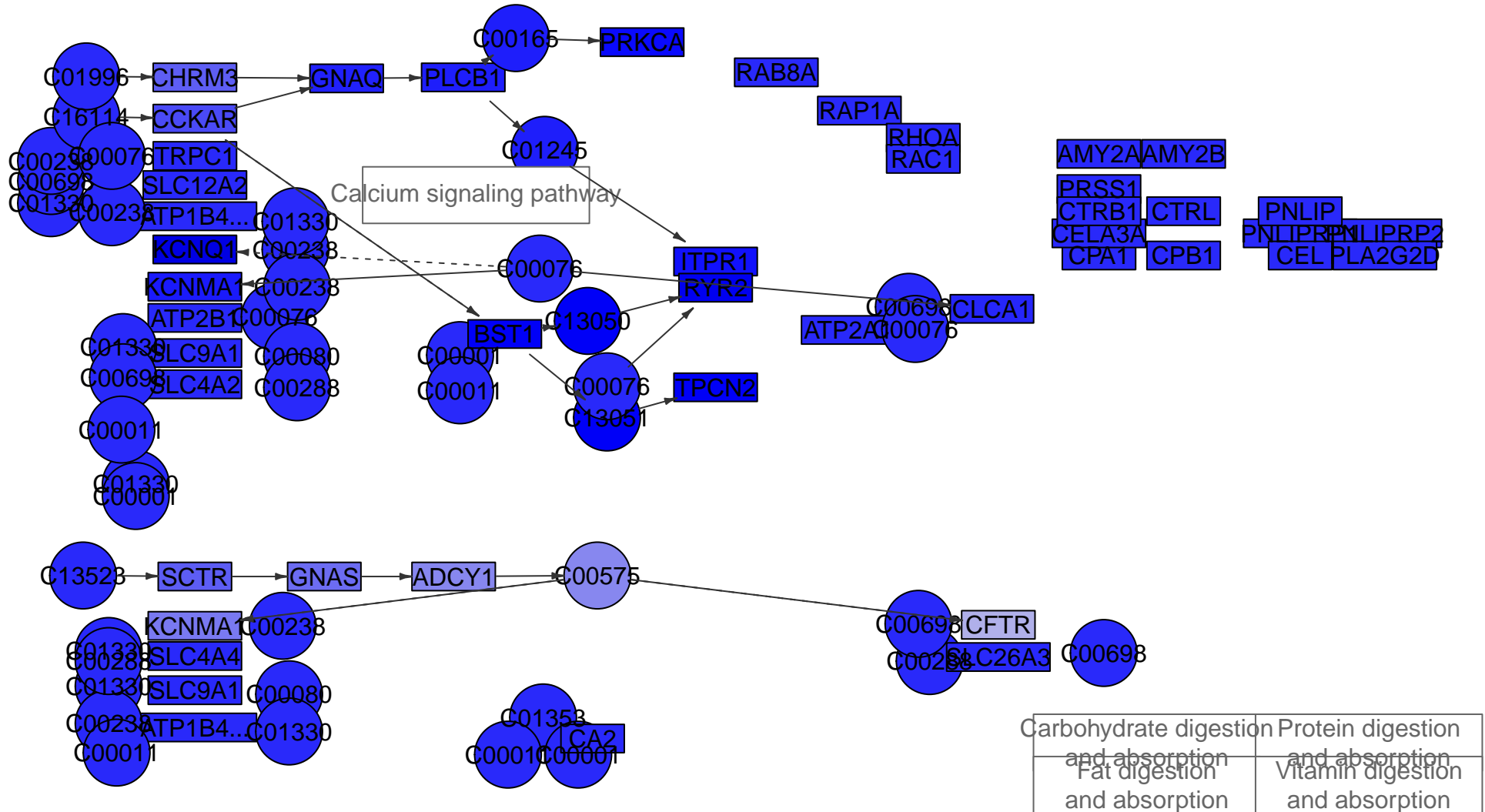

Pancreatic secretion
MPI-115



Tight junction

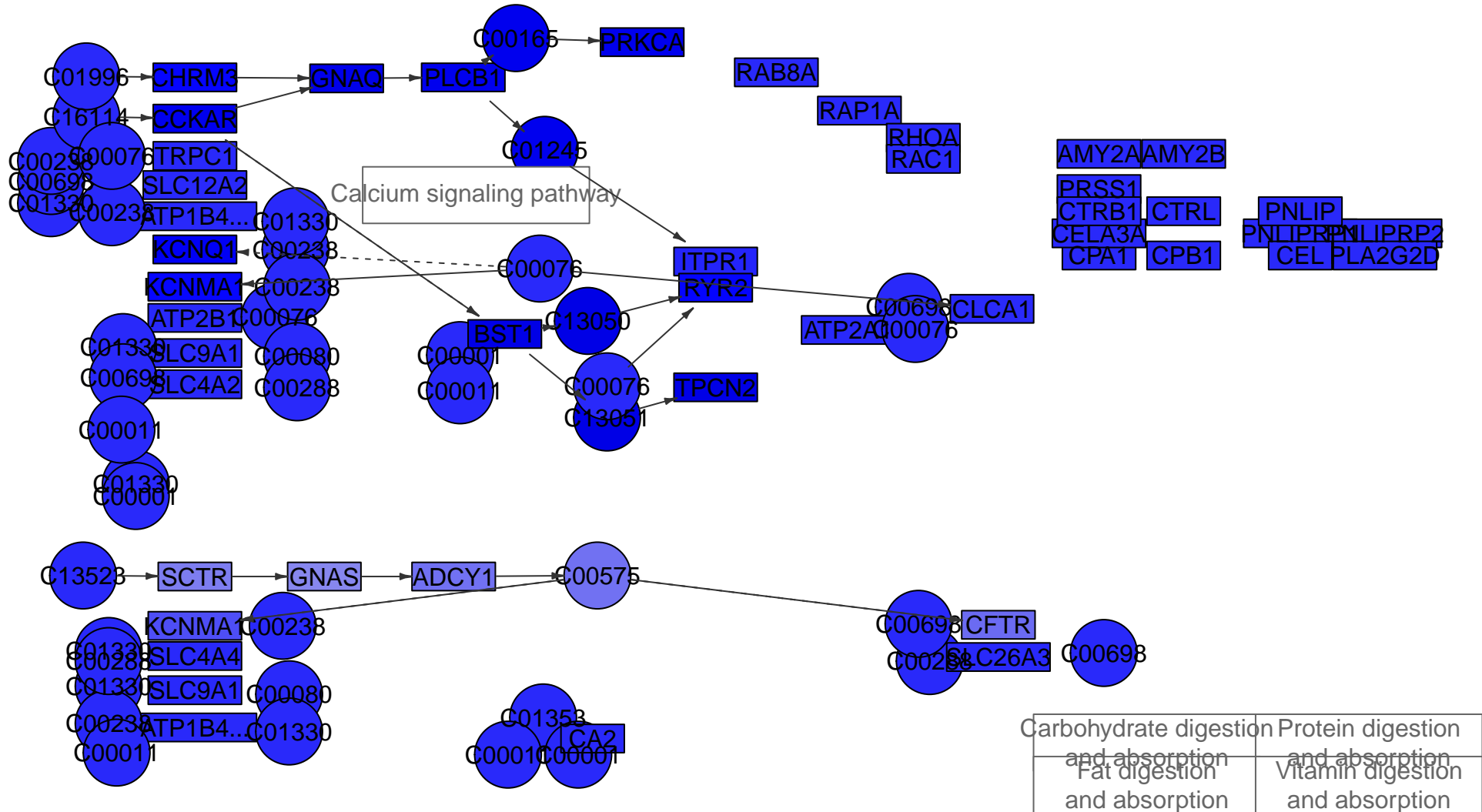

Pancreatic secretion
MPI-118



Tight junction

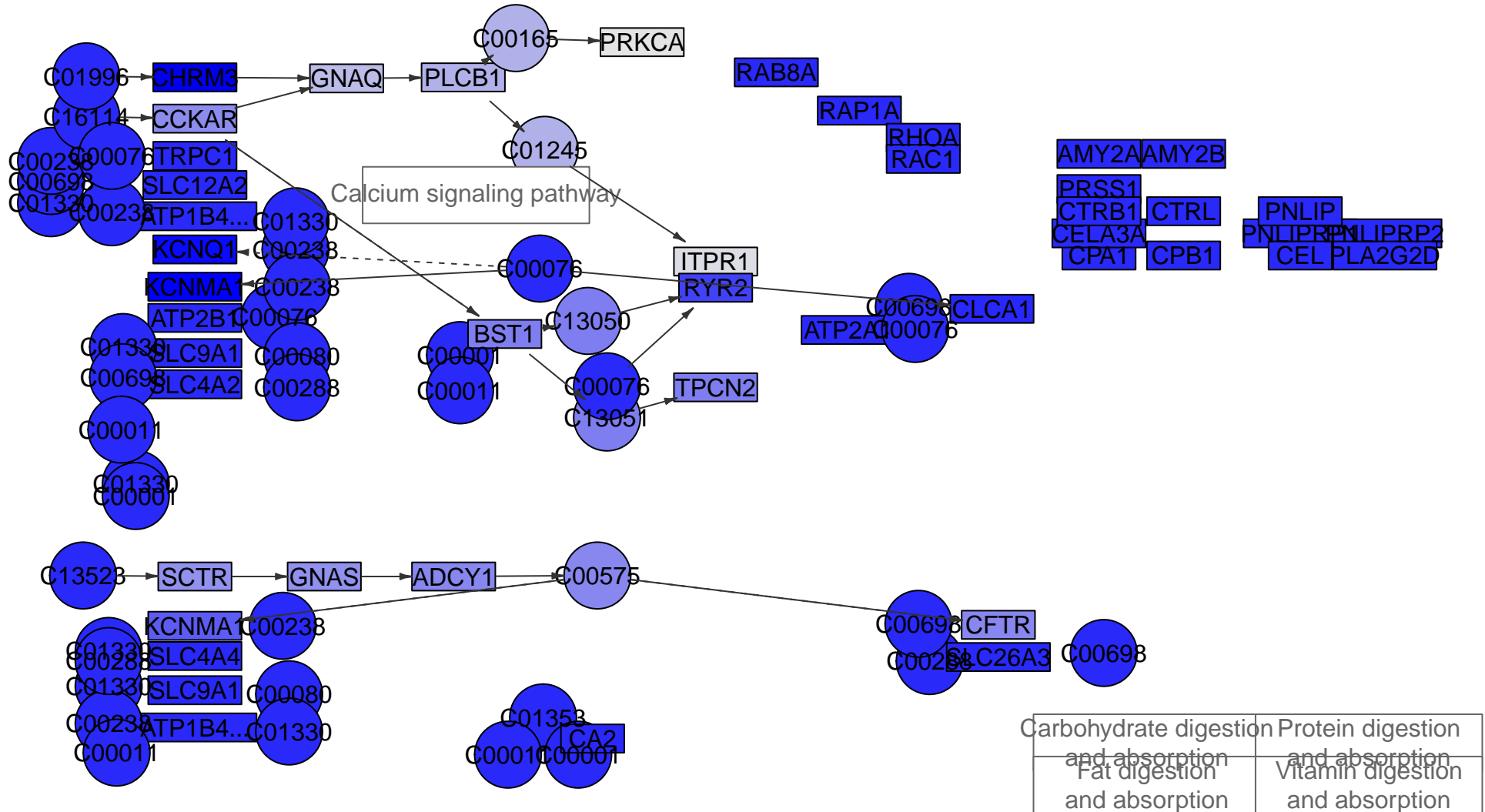

Pancreatic secretion
MPI-119

Tight junction

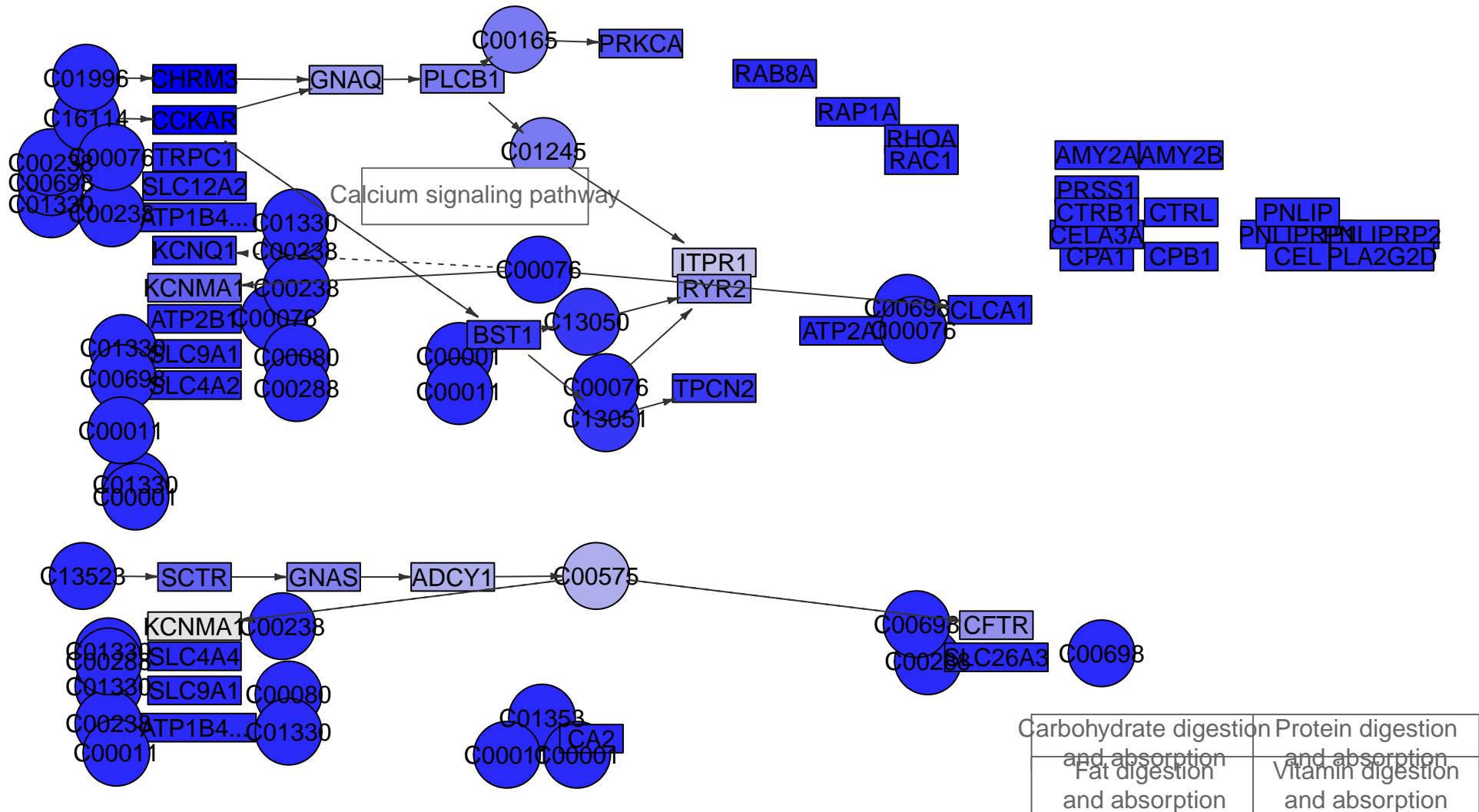

Pancreatic secretion
MPI-122



Tight junction

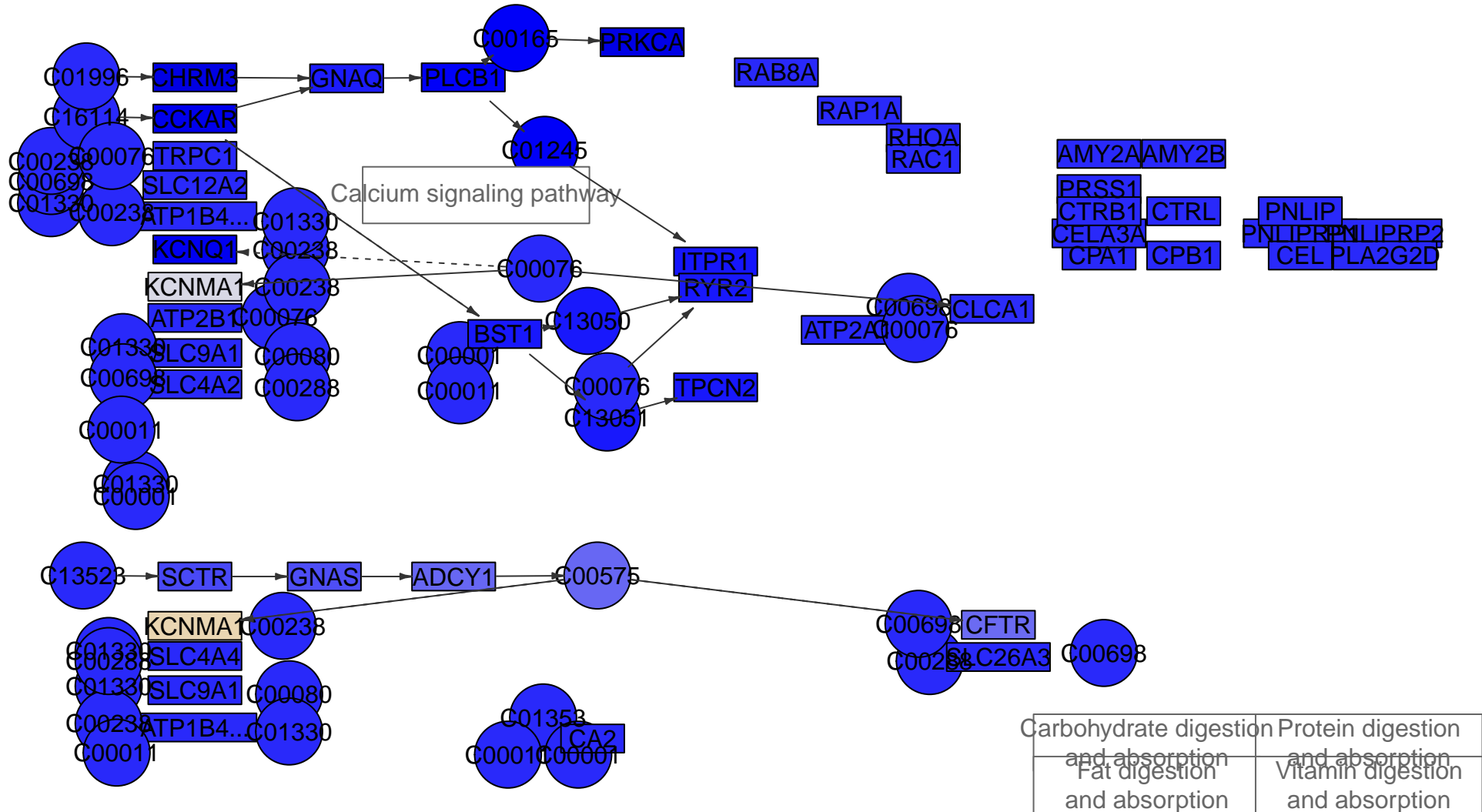

Pancreatic secretion
MPI-127

Tight junction

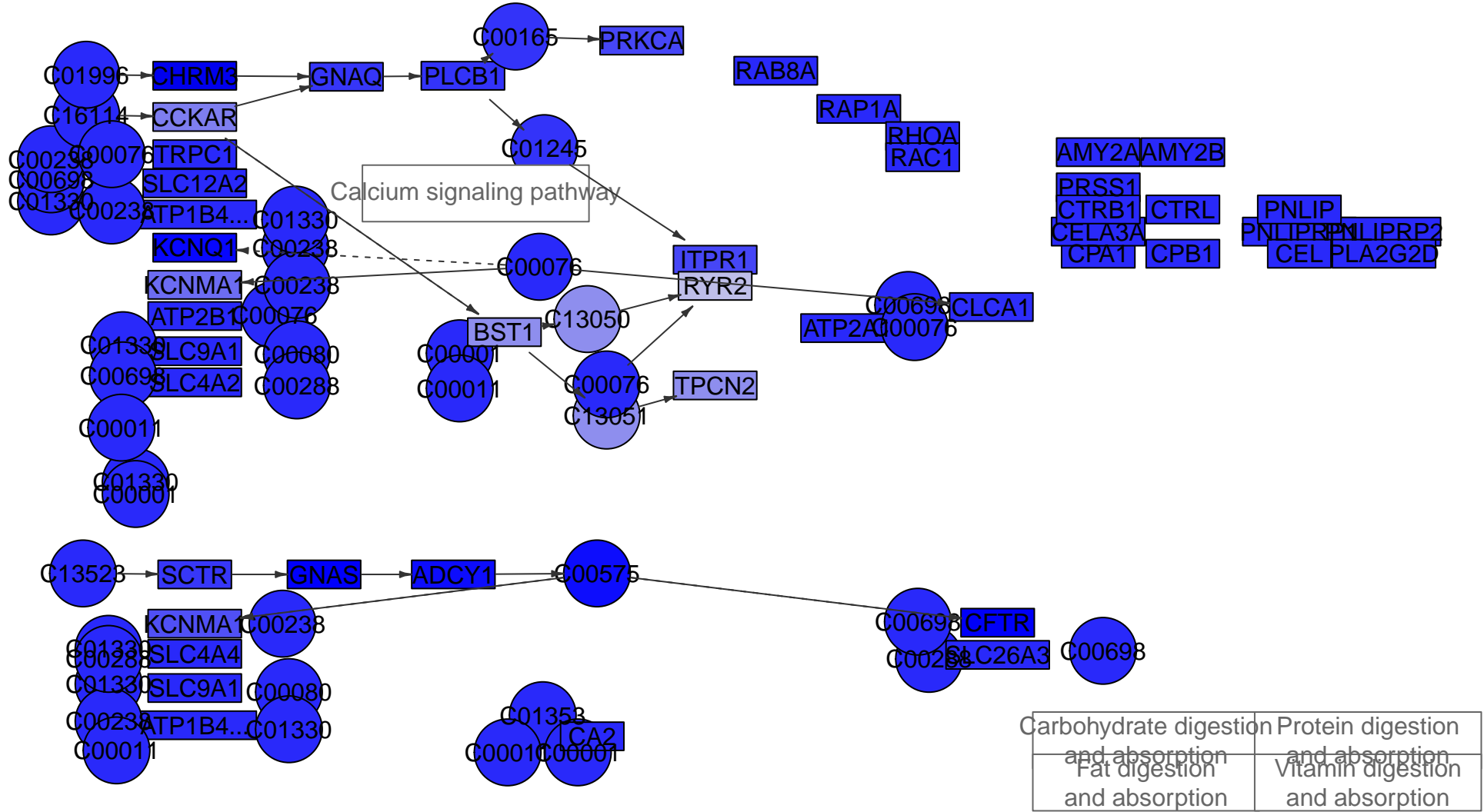

Pancreatic secretion
MPI-128



Tight junction

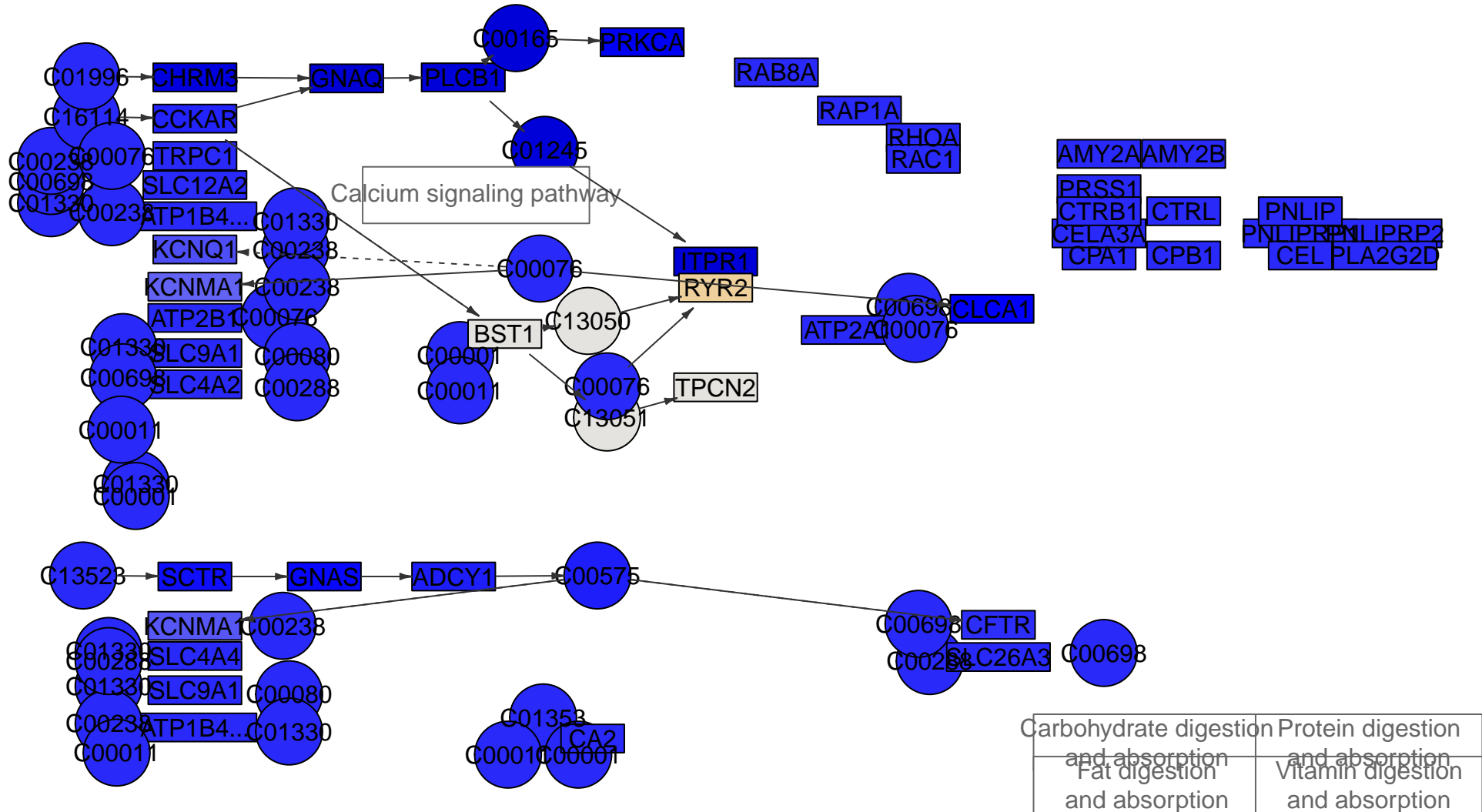

Pancreatic secretion
MPI-129



Tight junction

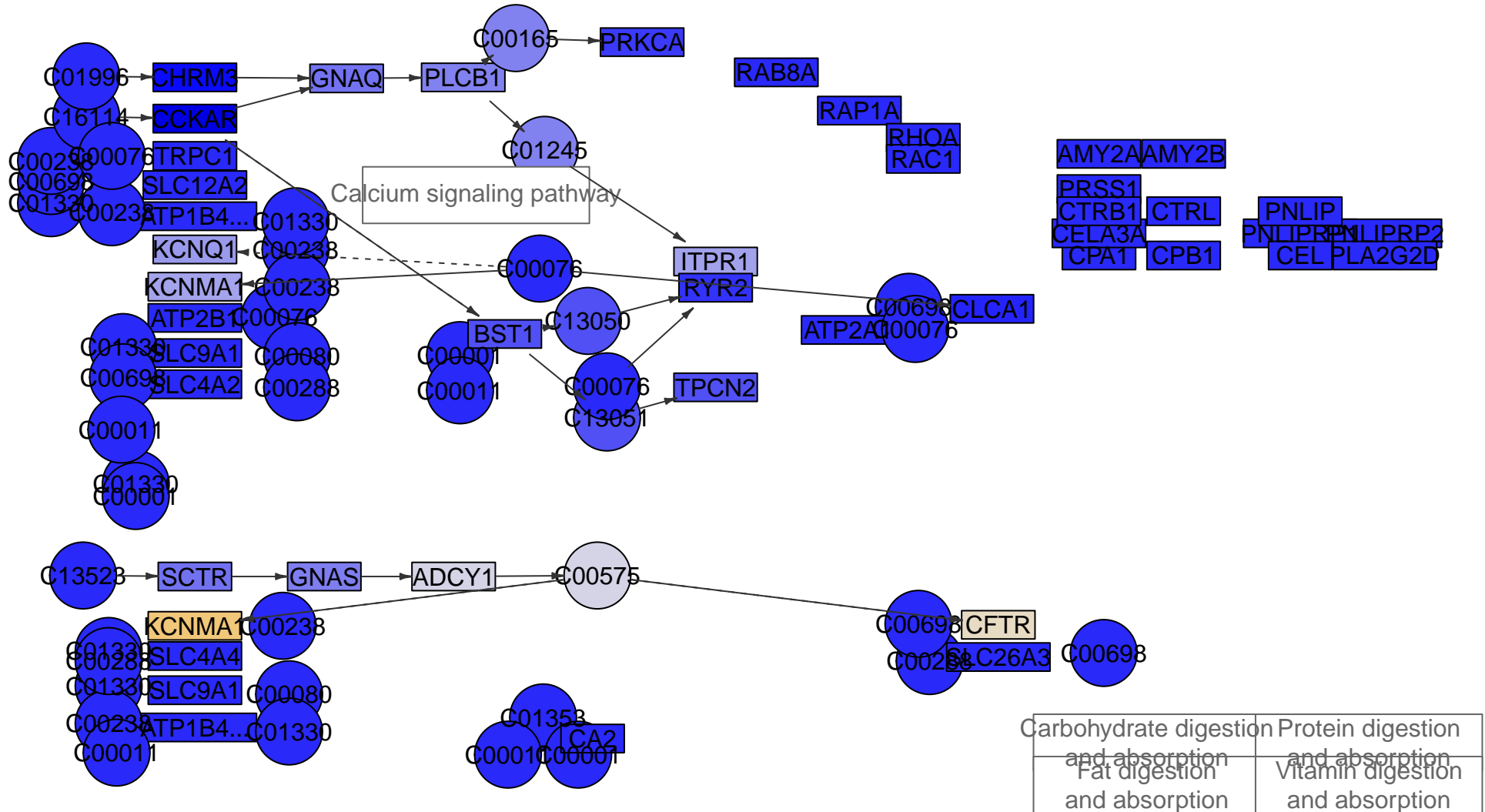

Pancreatic secretion
MPI-130



Tight junction

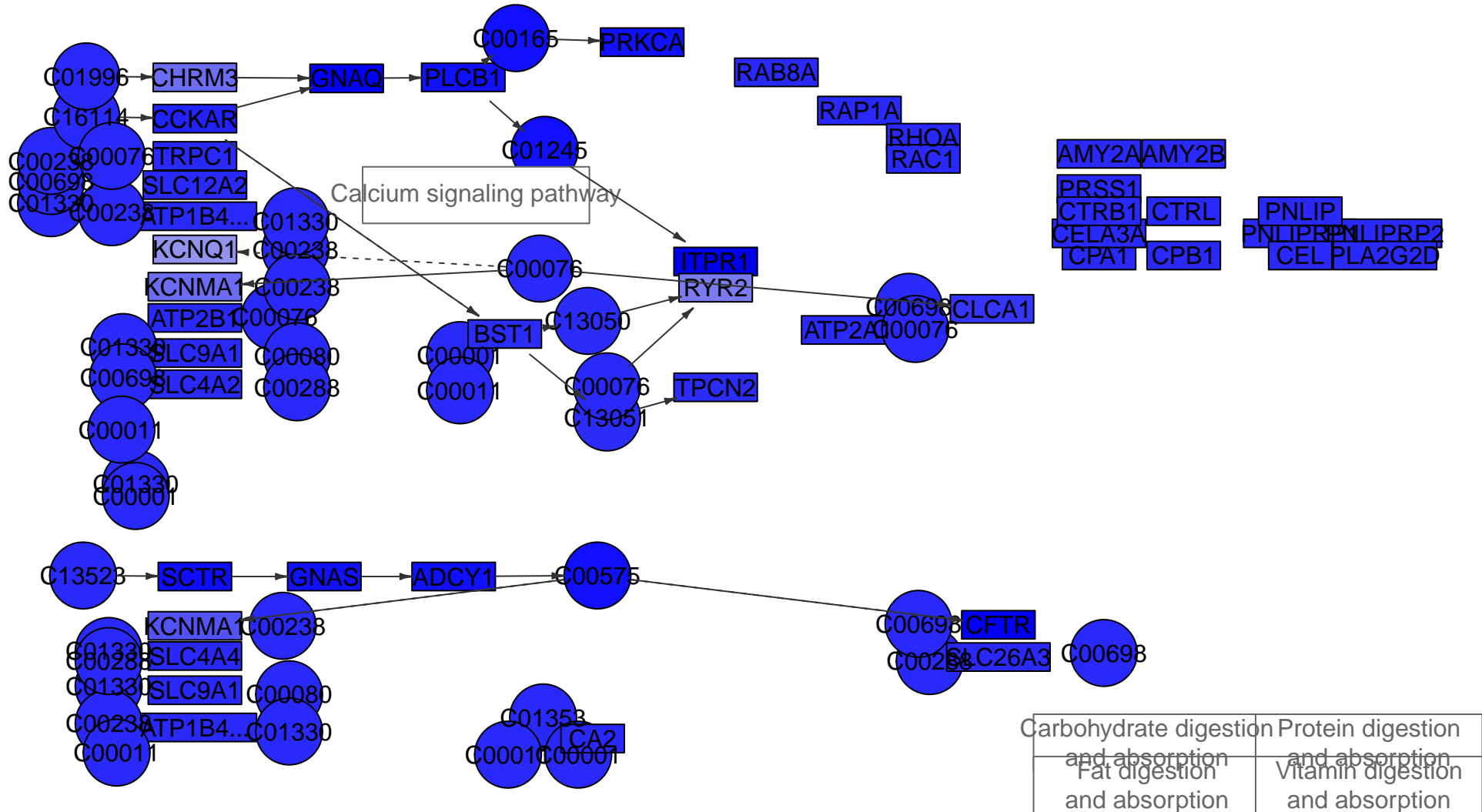

Pancreatic secretion
MPI-132



Tight junction

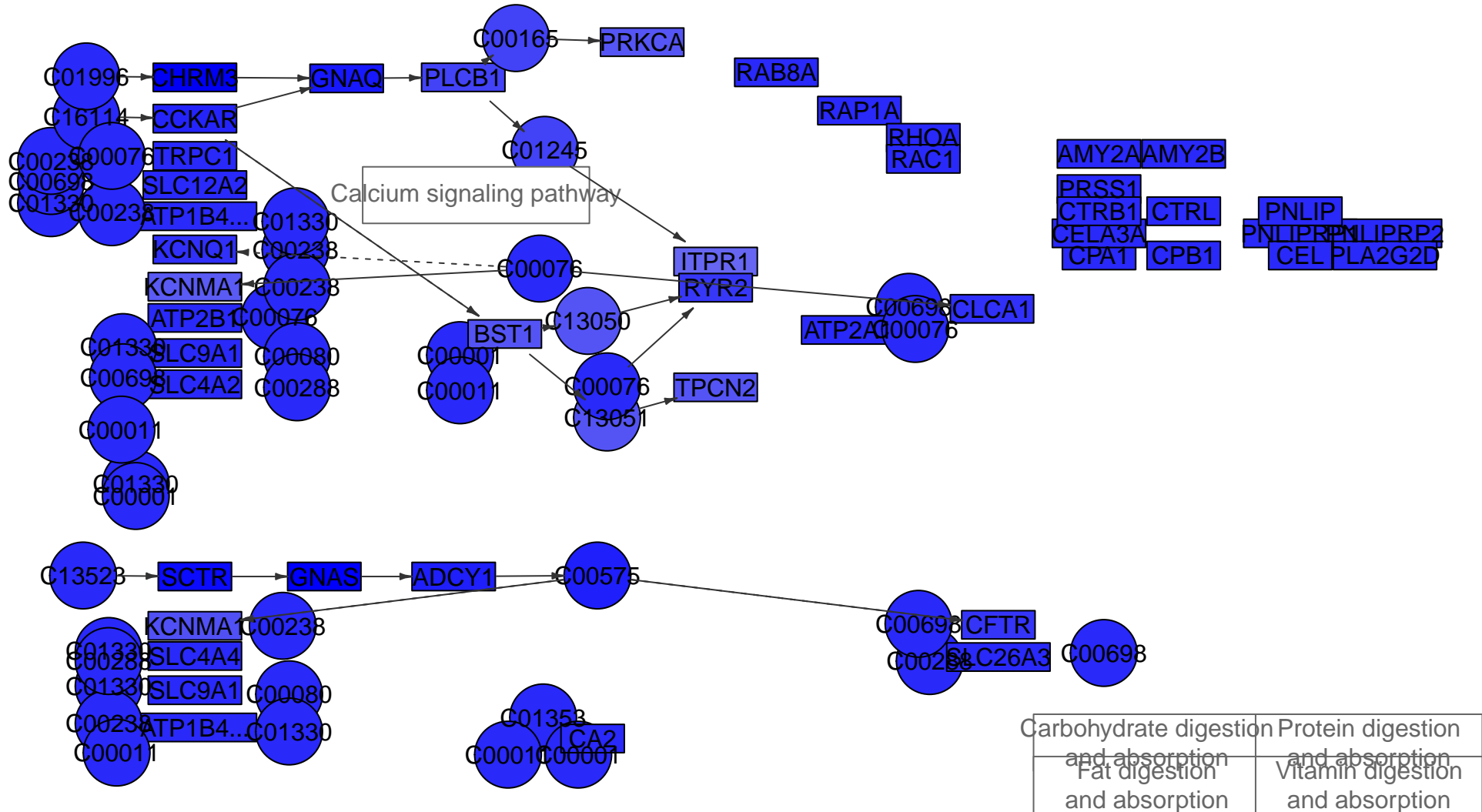

Pancreatic secretion
MPI-133



Tight junction

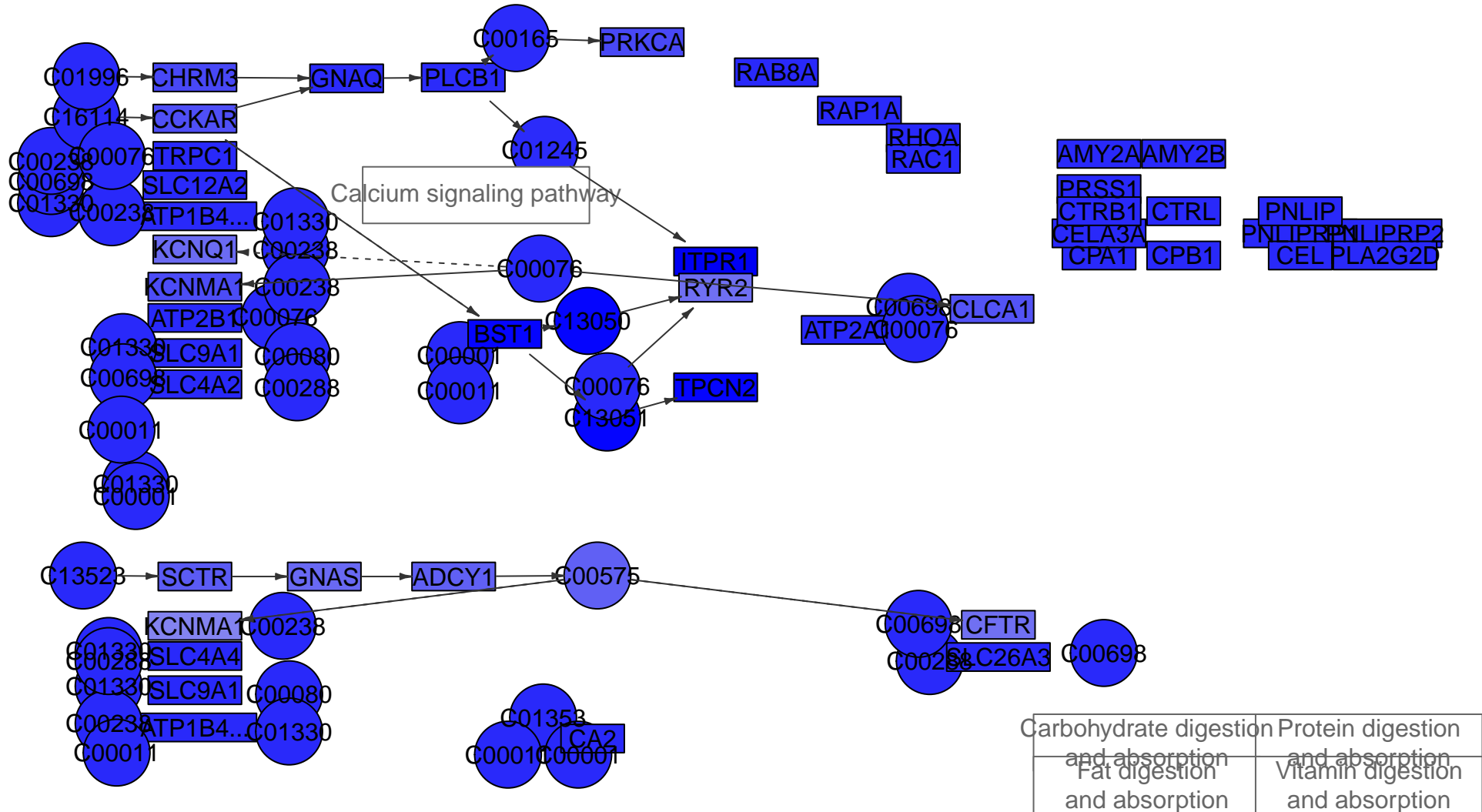

Pancreatic secretion
MPI-134

Tight junction

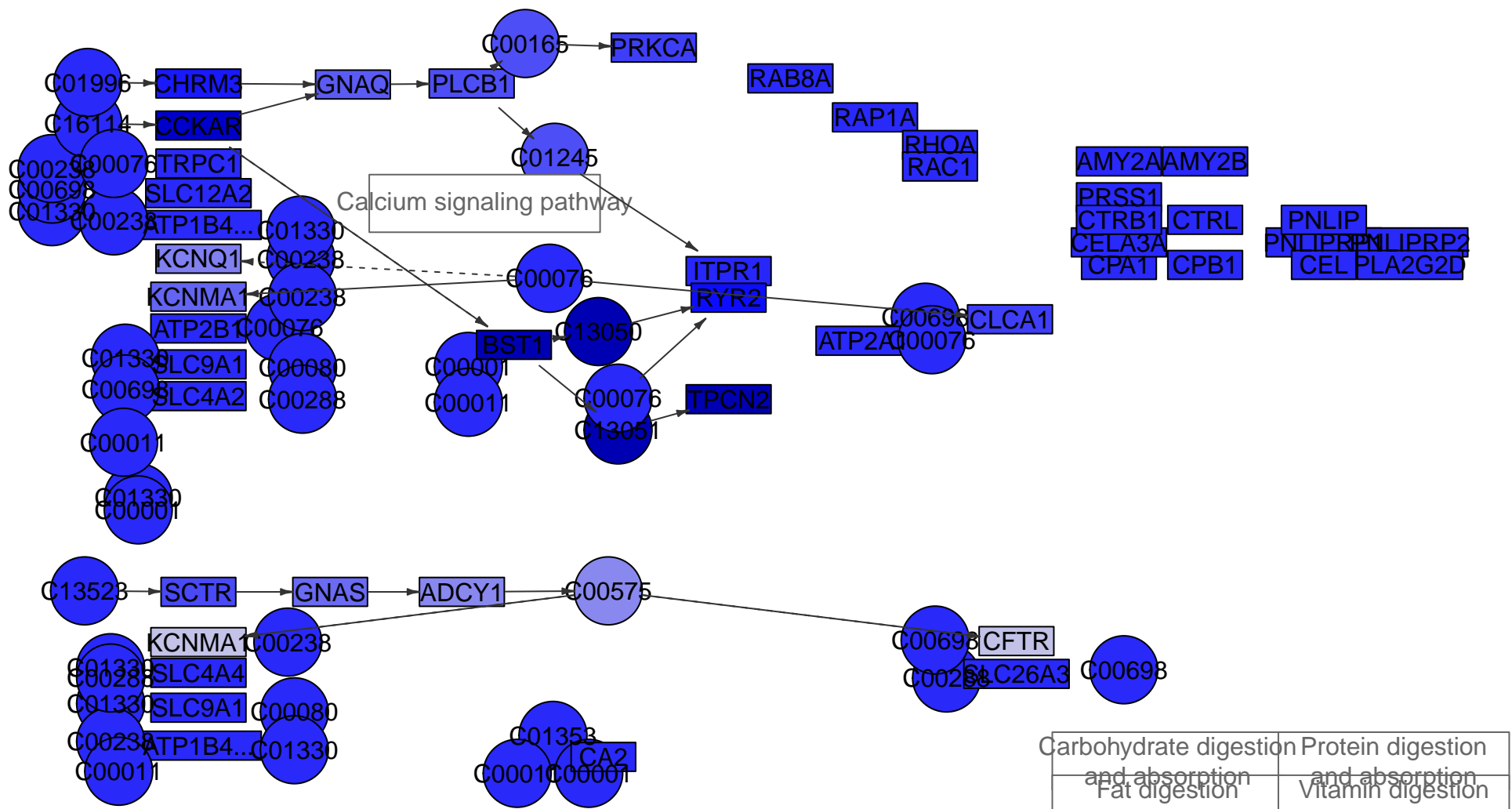

Pancreatic secretion
MPI-135



Tight junction

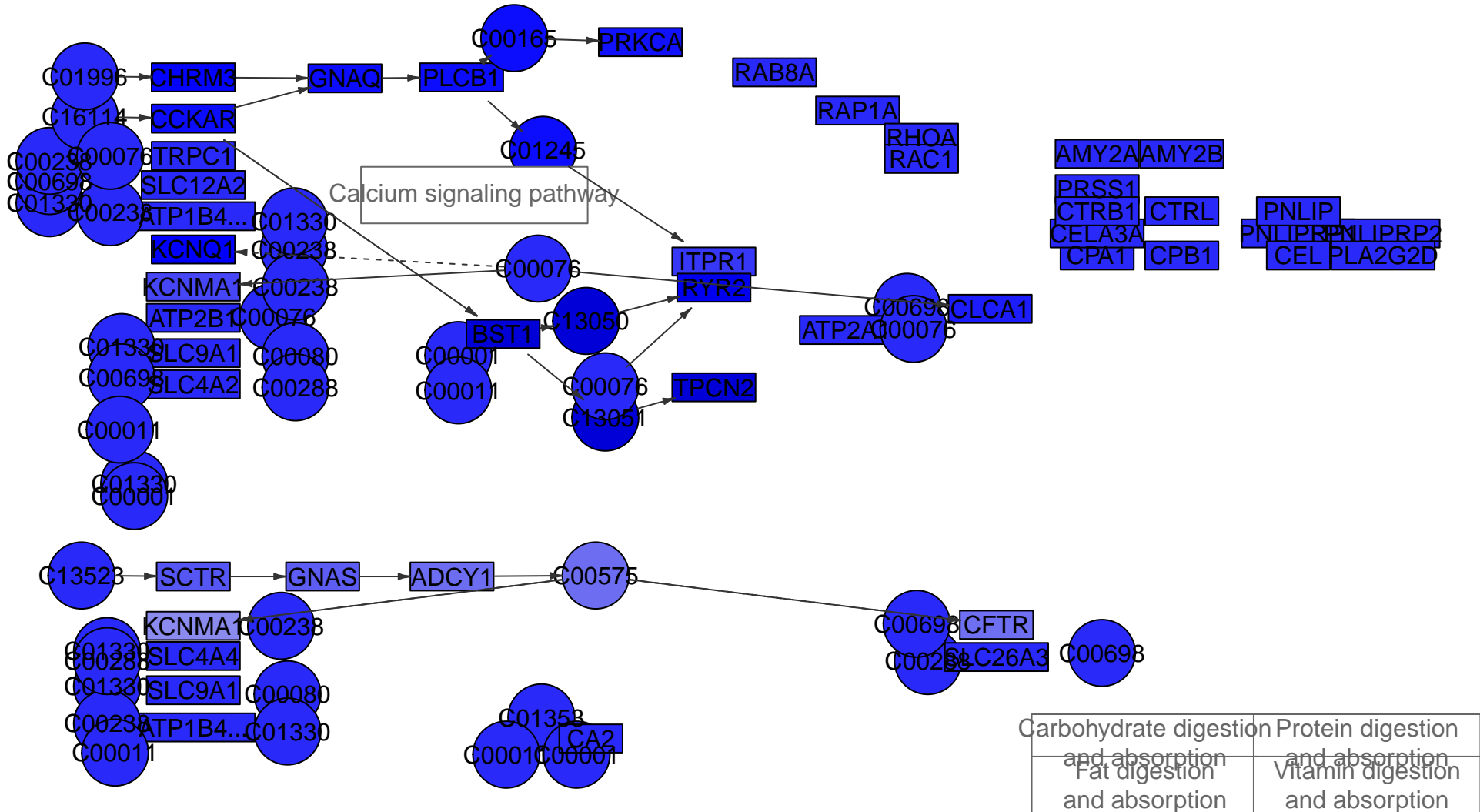

Pancreatic secretion
MPI-136

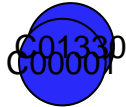

Tight junction

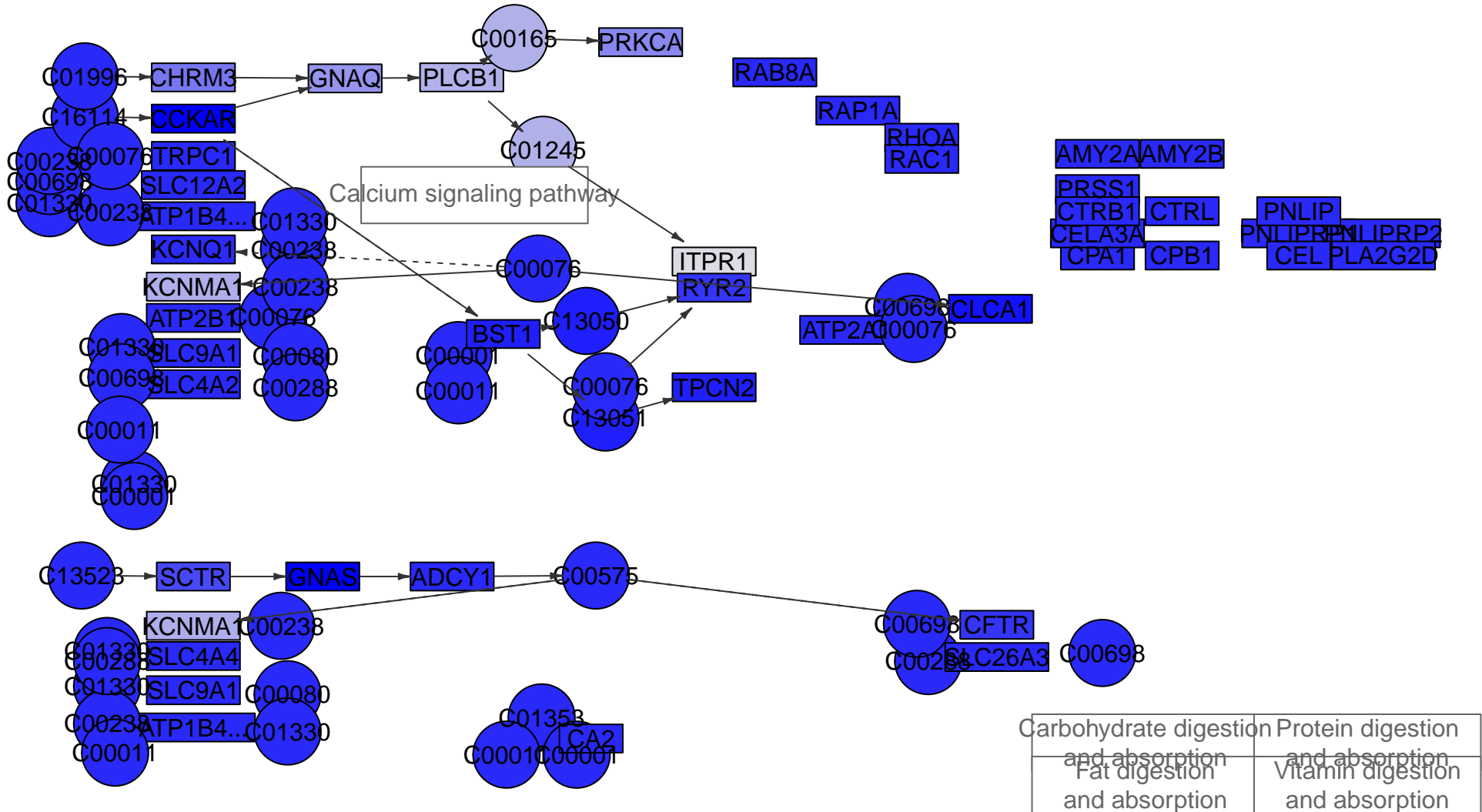

Pancreatic secretion
MPI-141



Tight junction

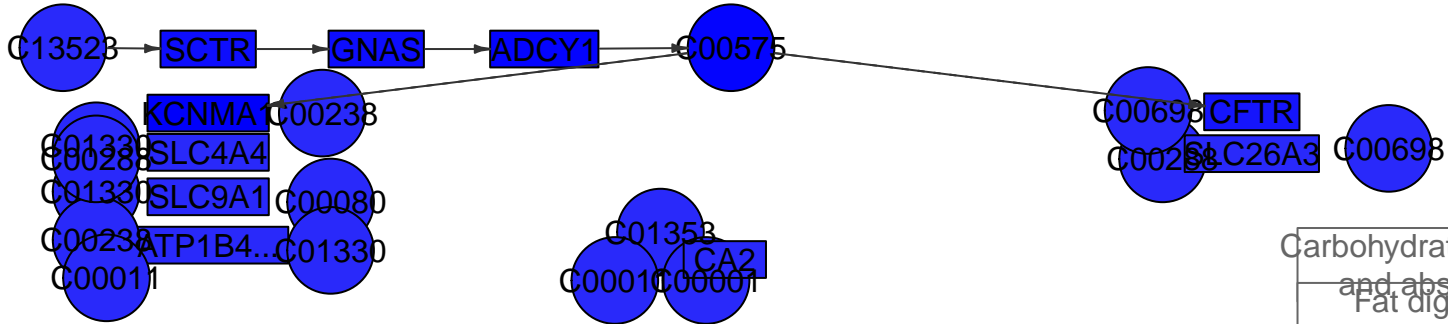
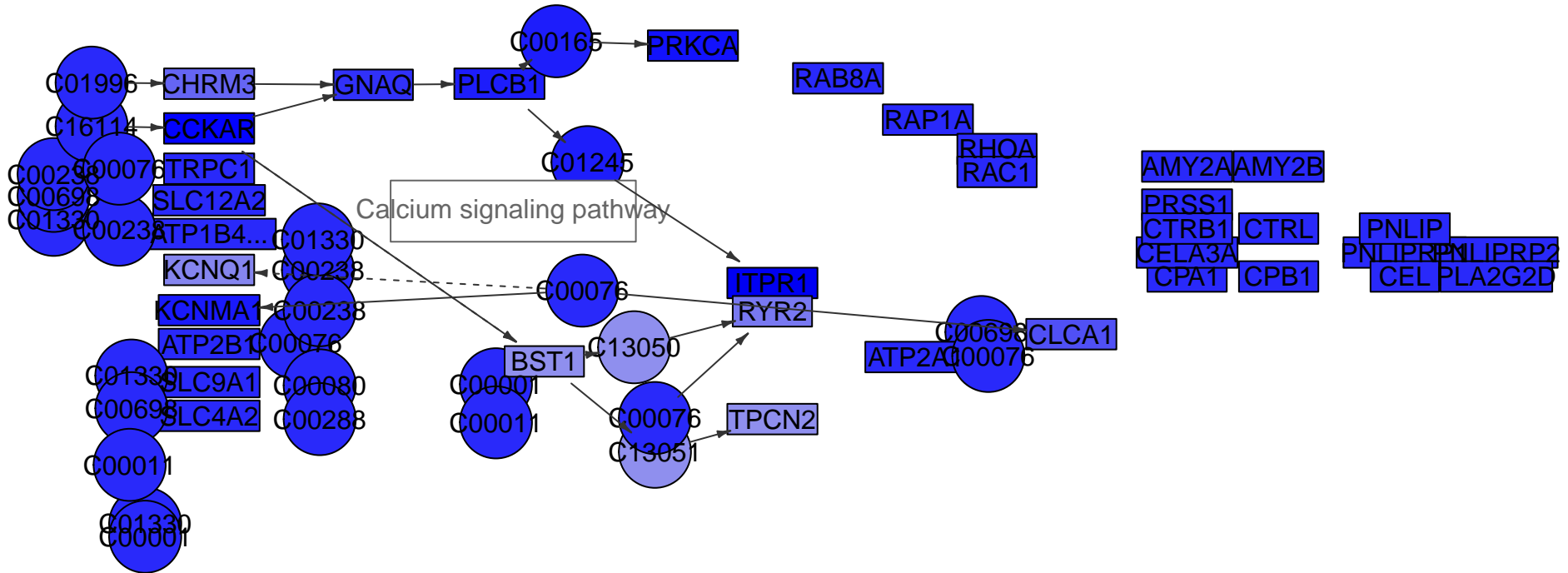

Carbohydrate digestion and absorption	Protein digestion and absorption
Fat digestion and absorption	Vitamin digestion and absorption

Pancreatic secretion
MPI-142

Tight junction

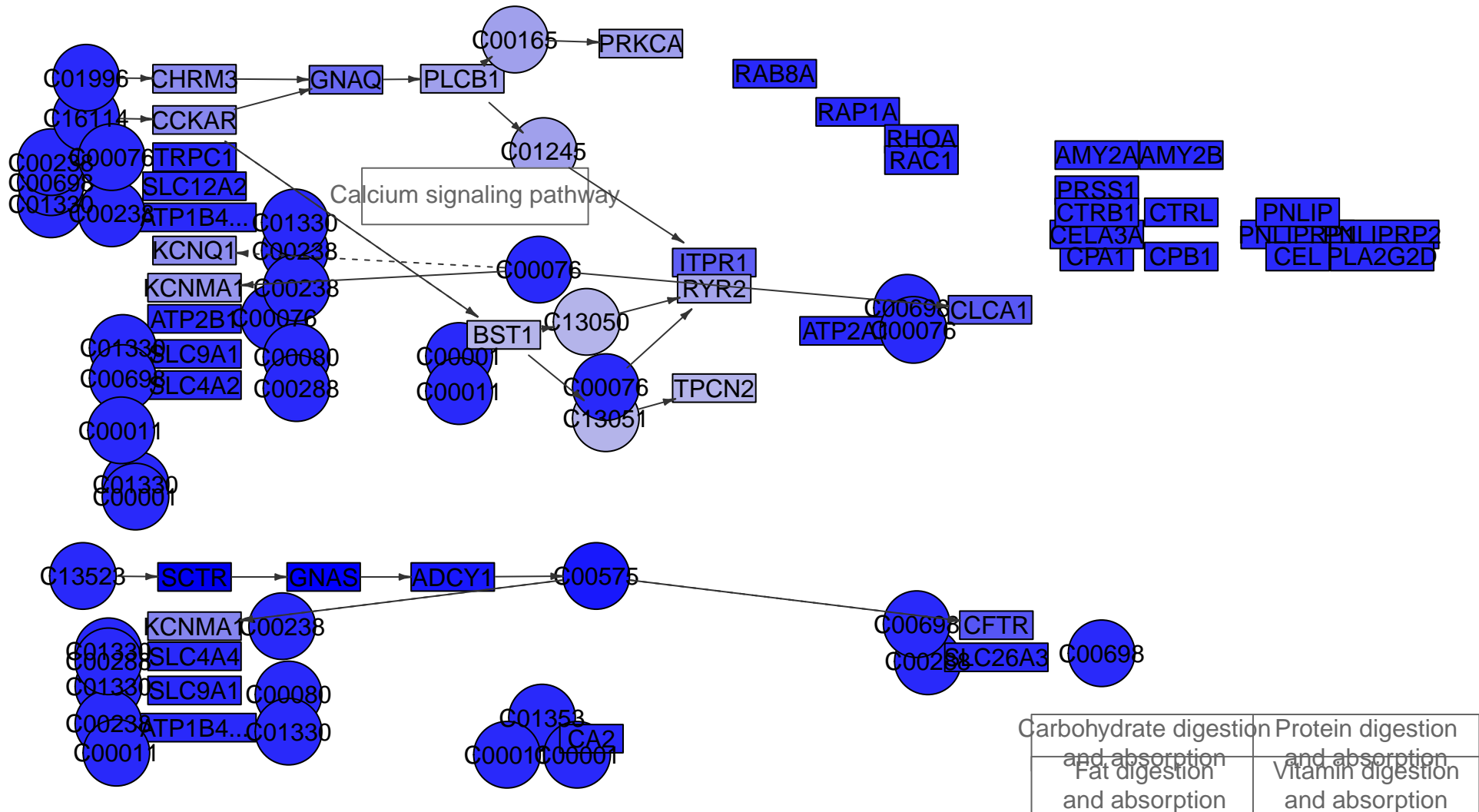

Pancreatic secretion
MPI-145



Tight junction

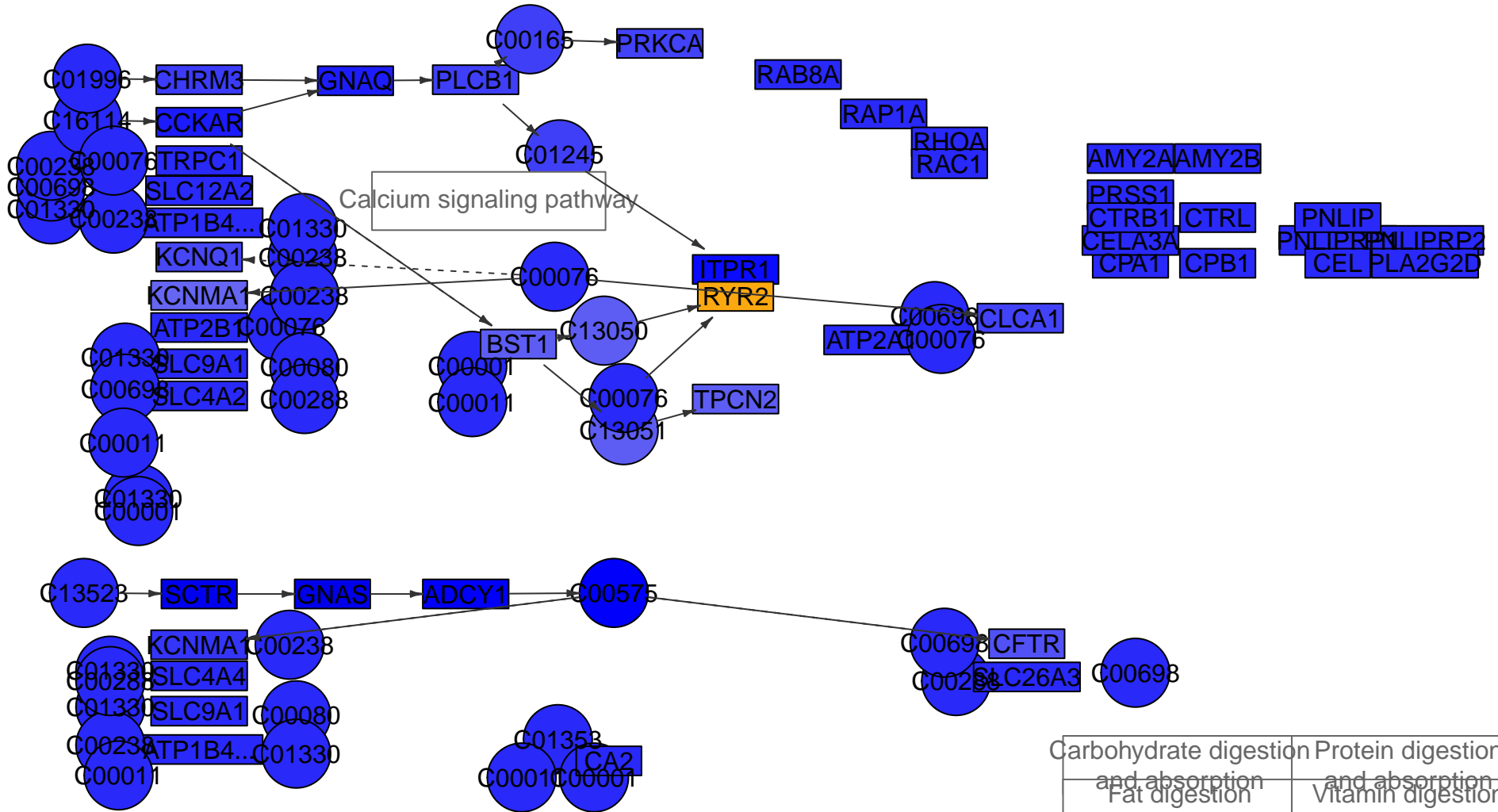

Carbohydrate digestion and absorption	Protein digestion and absorption
Fat digestion and absorption	Vitamin digestion and absorption

Pancreatic secretion
MPI-146



Tight junction

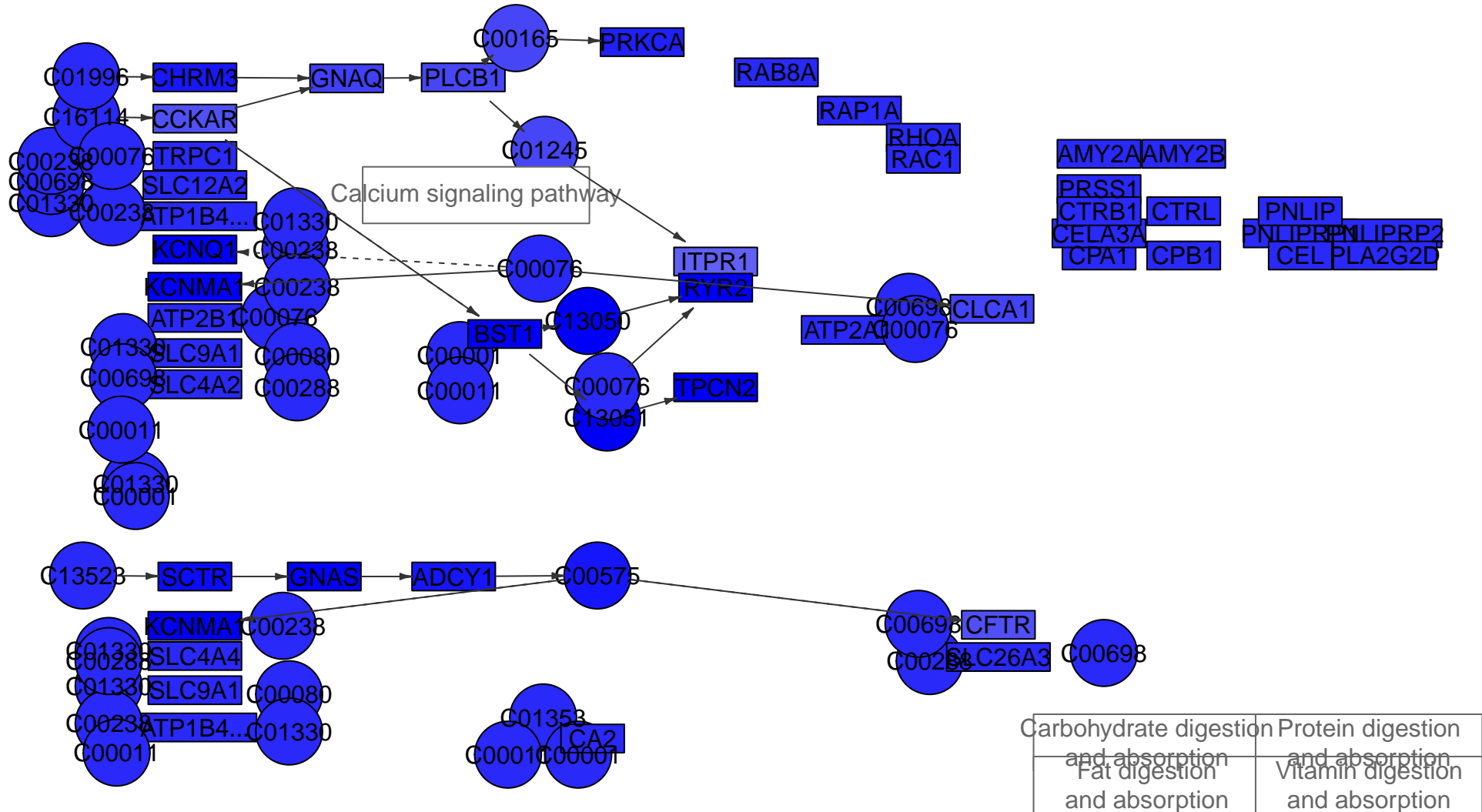

Pancreatic secretion
MPI-149



Tight junction

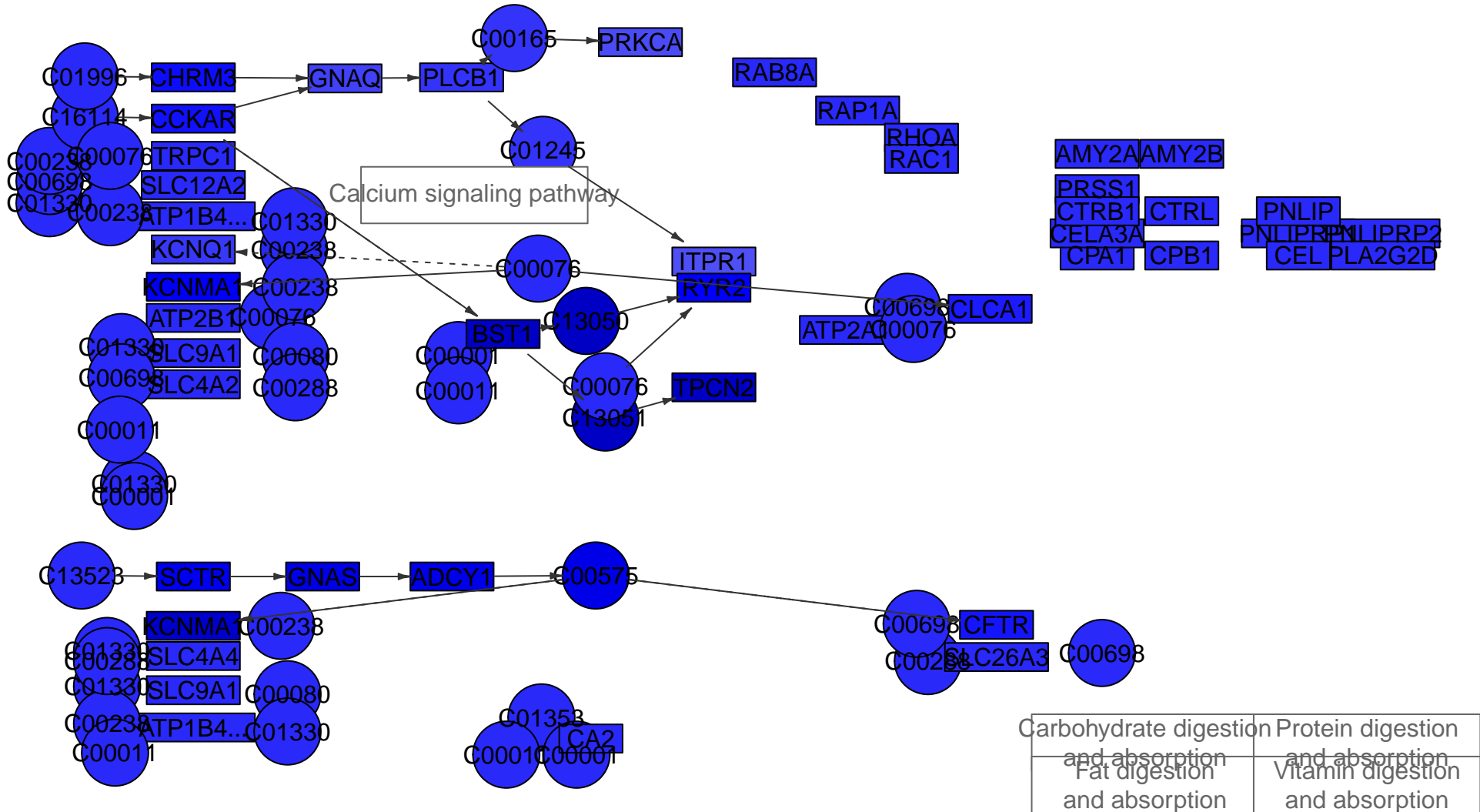

Pancreatic secretion
MPI-150

Tight junction

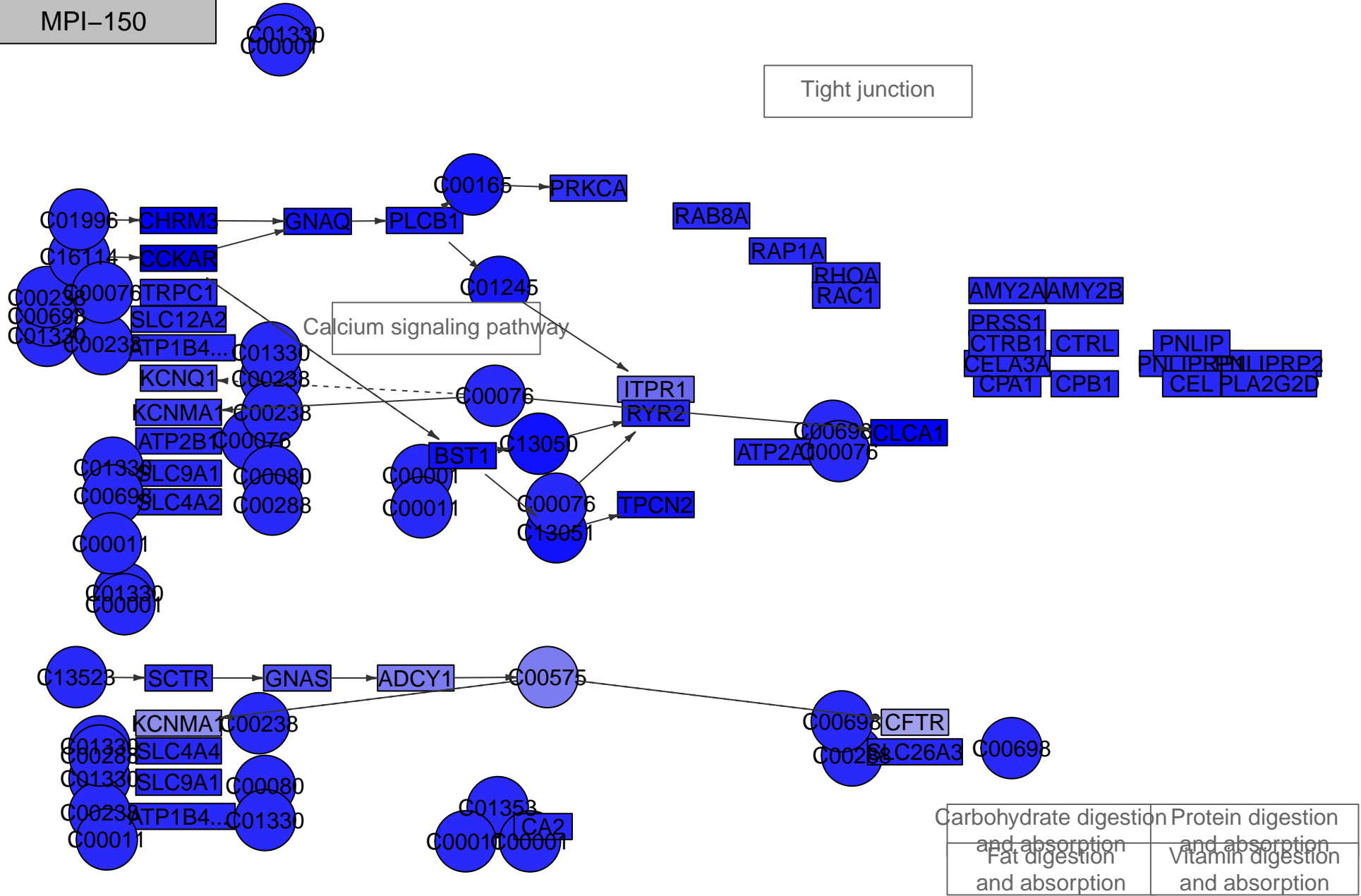

Pancreatic secretion
MPI-151



Tight junction

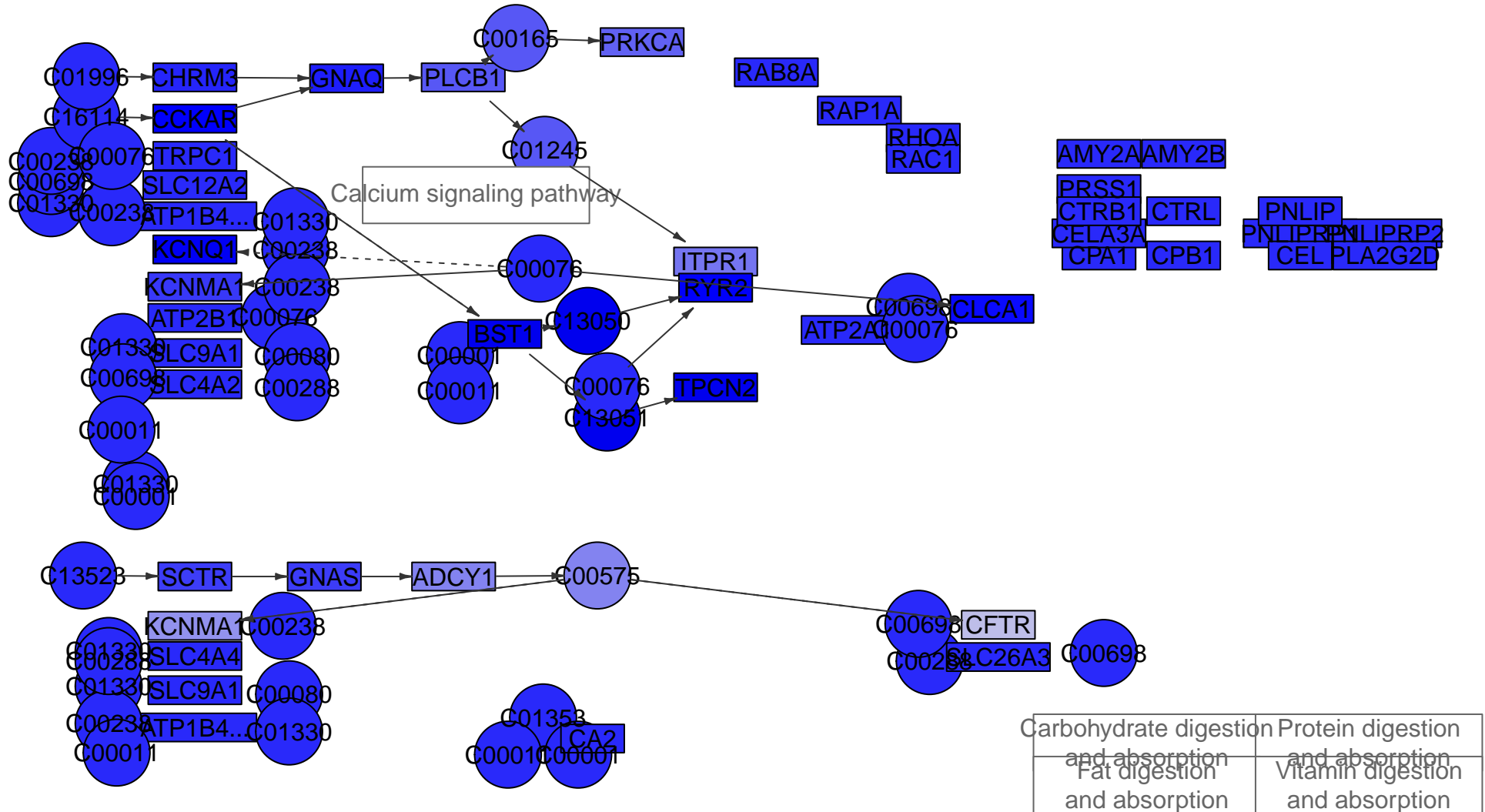

Pancreatic secretion
MPI-152



Tight junction

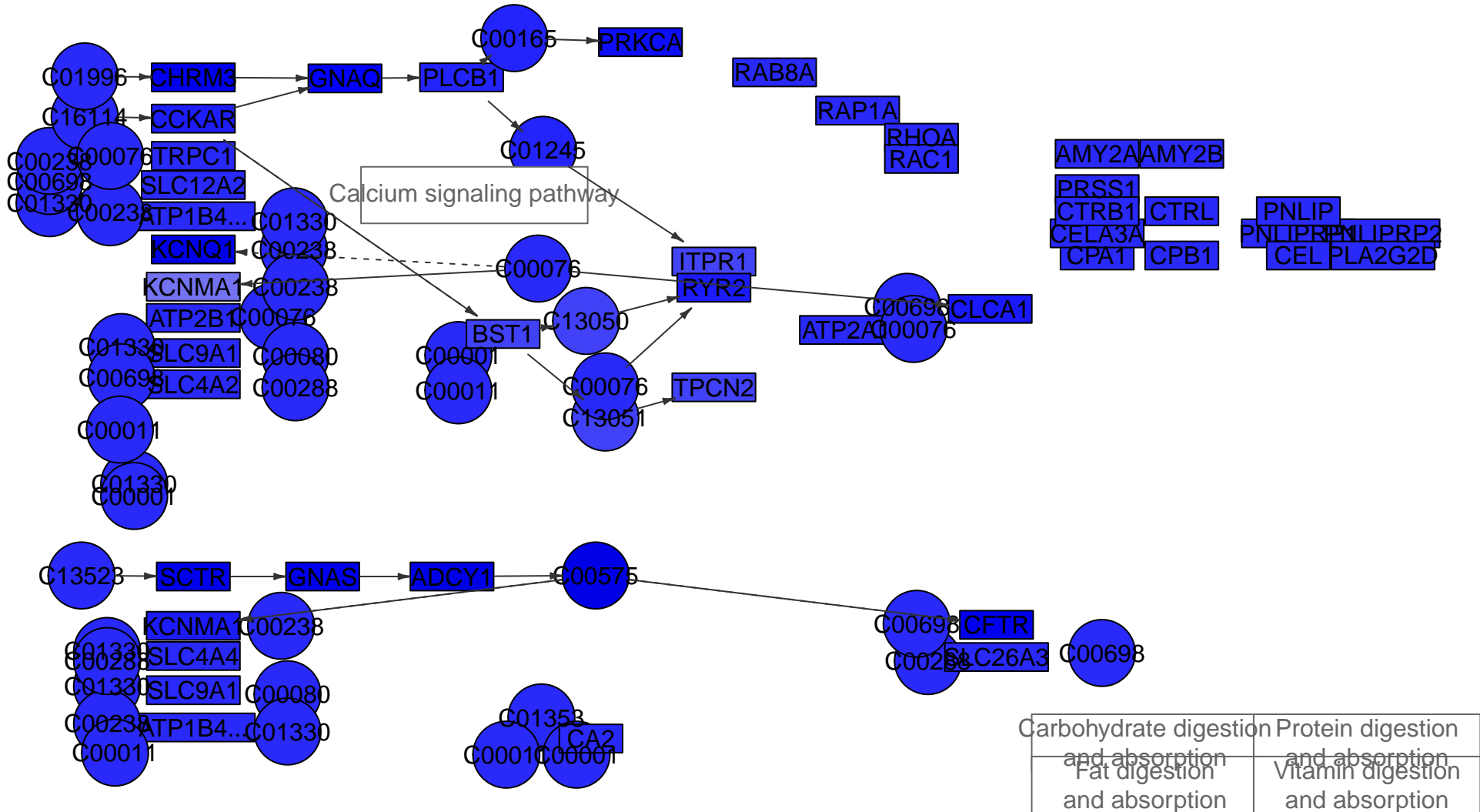

Pancreatic secretion
MPI-153



Tight junction

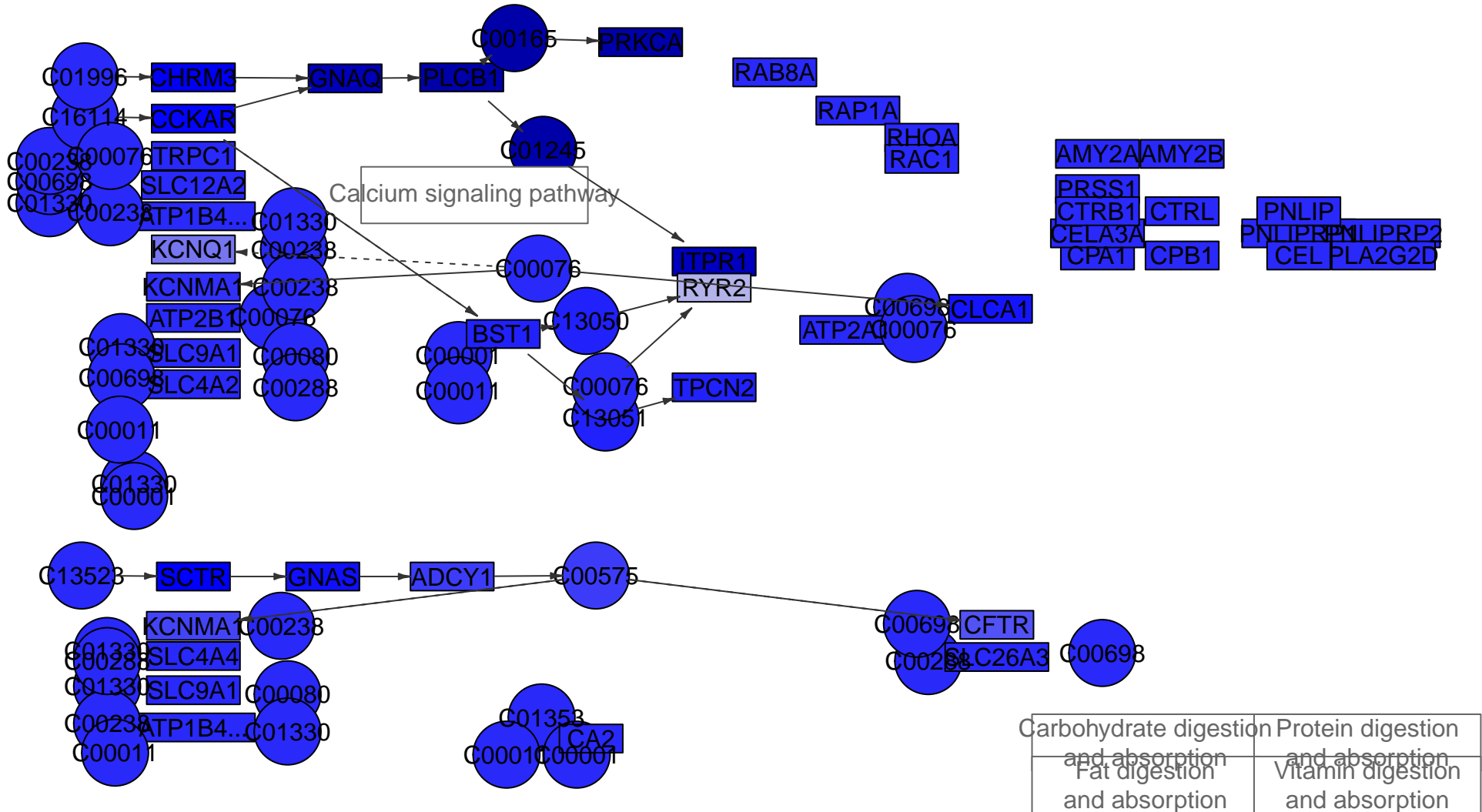

Pancreatic secretion
MPI-155



Tight junction

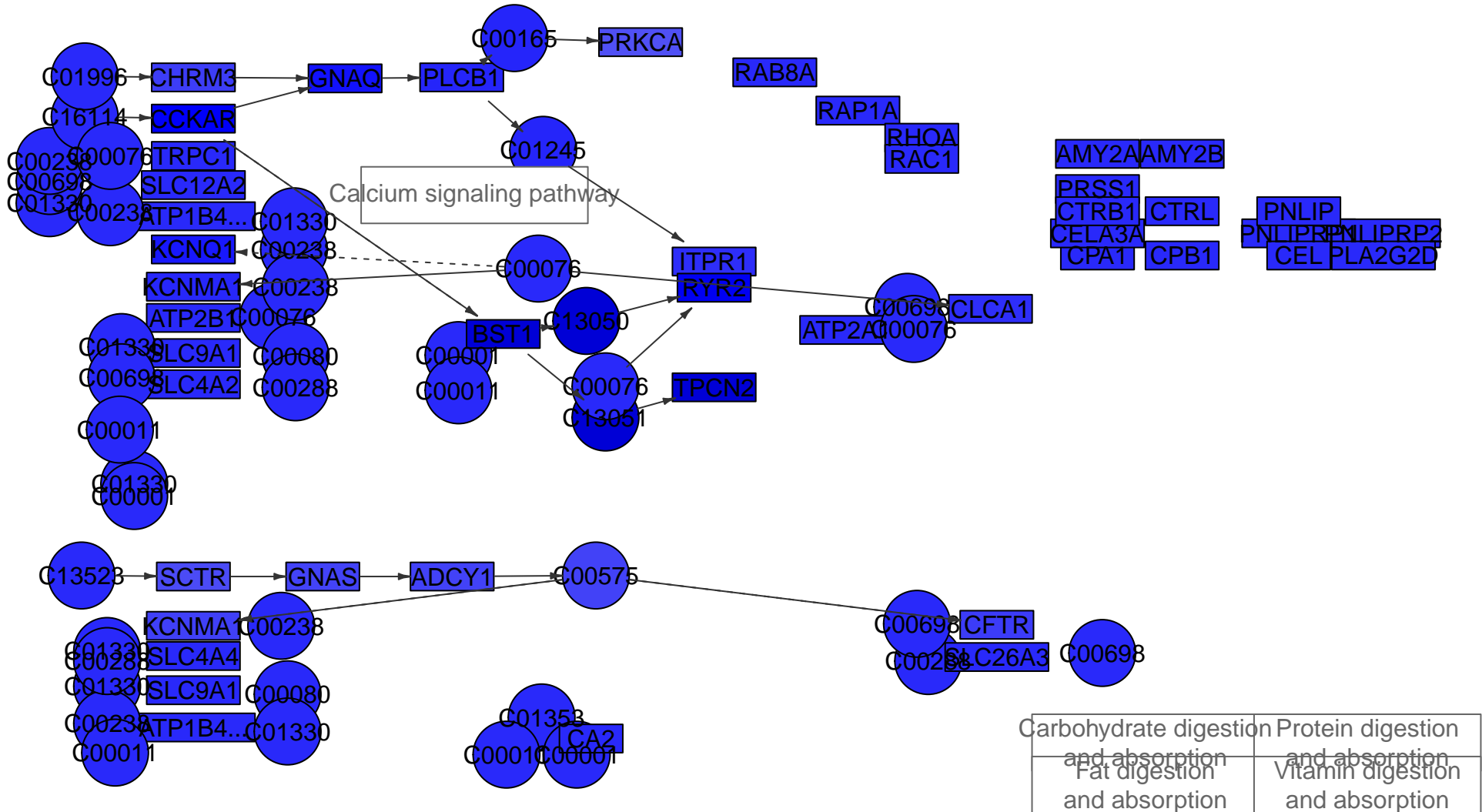

Pancreatic secretion
MPI-159

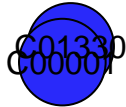

Tight junction

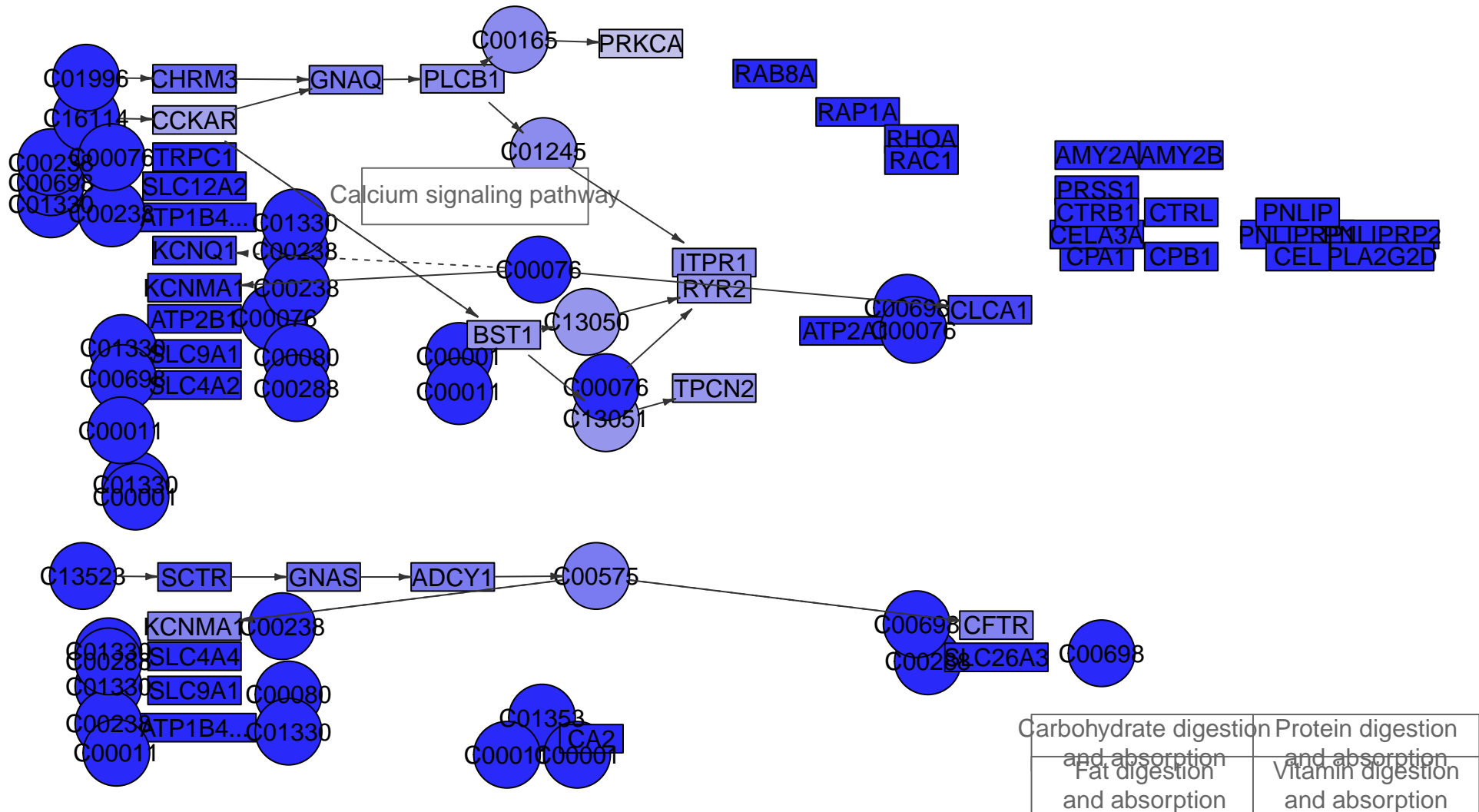

Pancreatic secretion
MPI-163

Tight junction

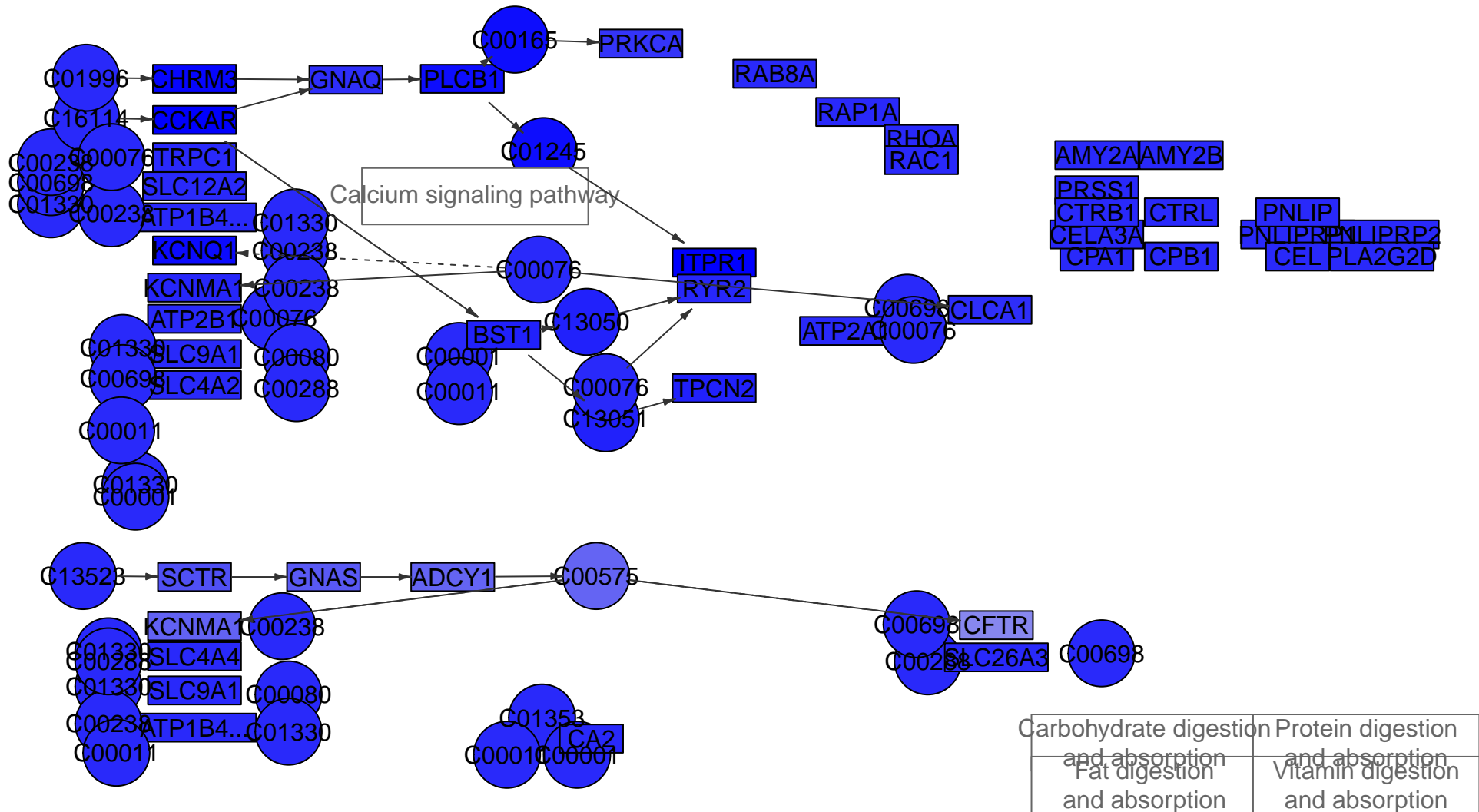

Pancreatic secretion
MPI-164



Tight junction

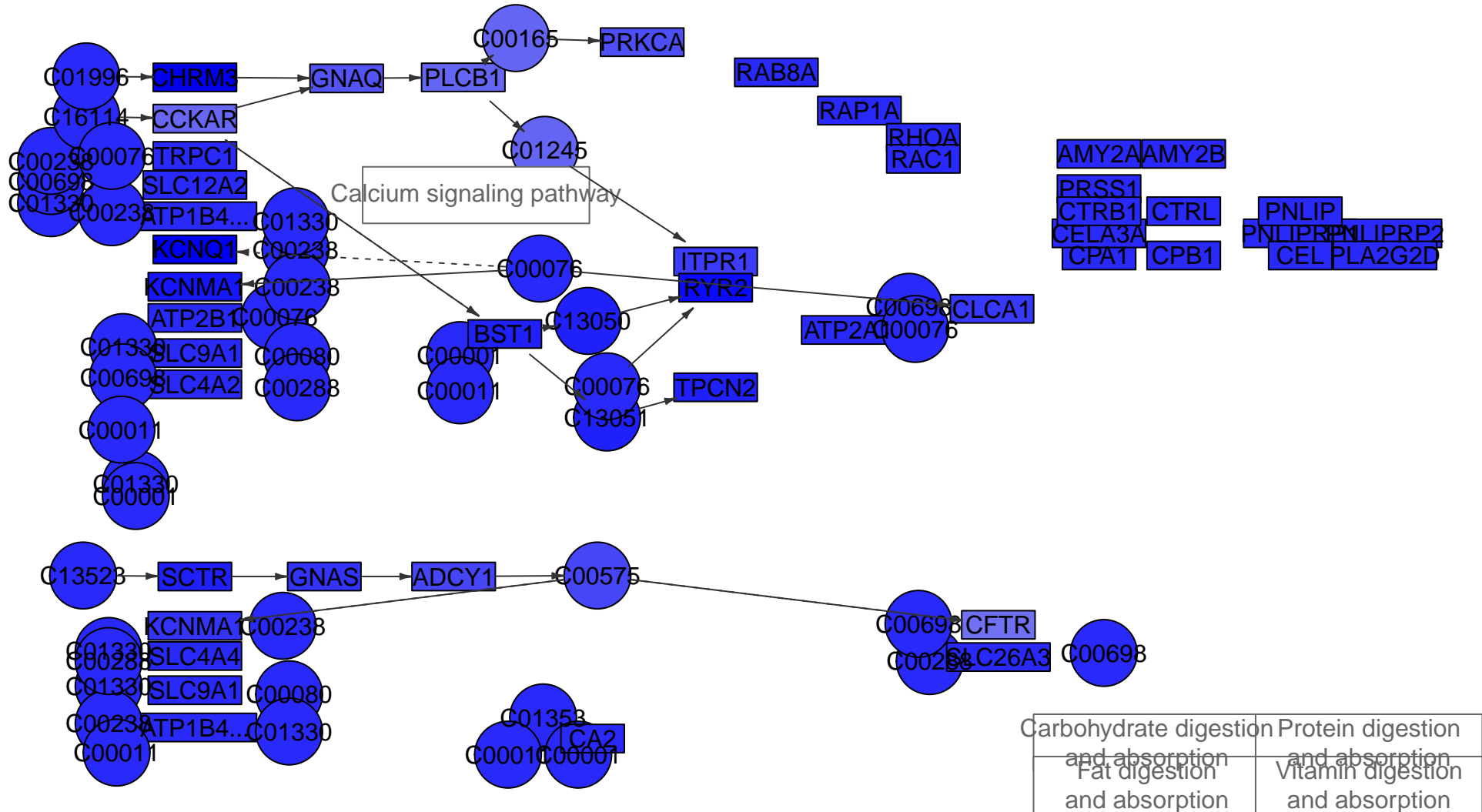

Pancreatic secretion
MPI-166



Tight junction

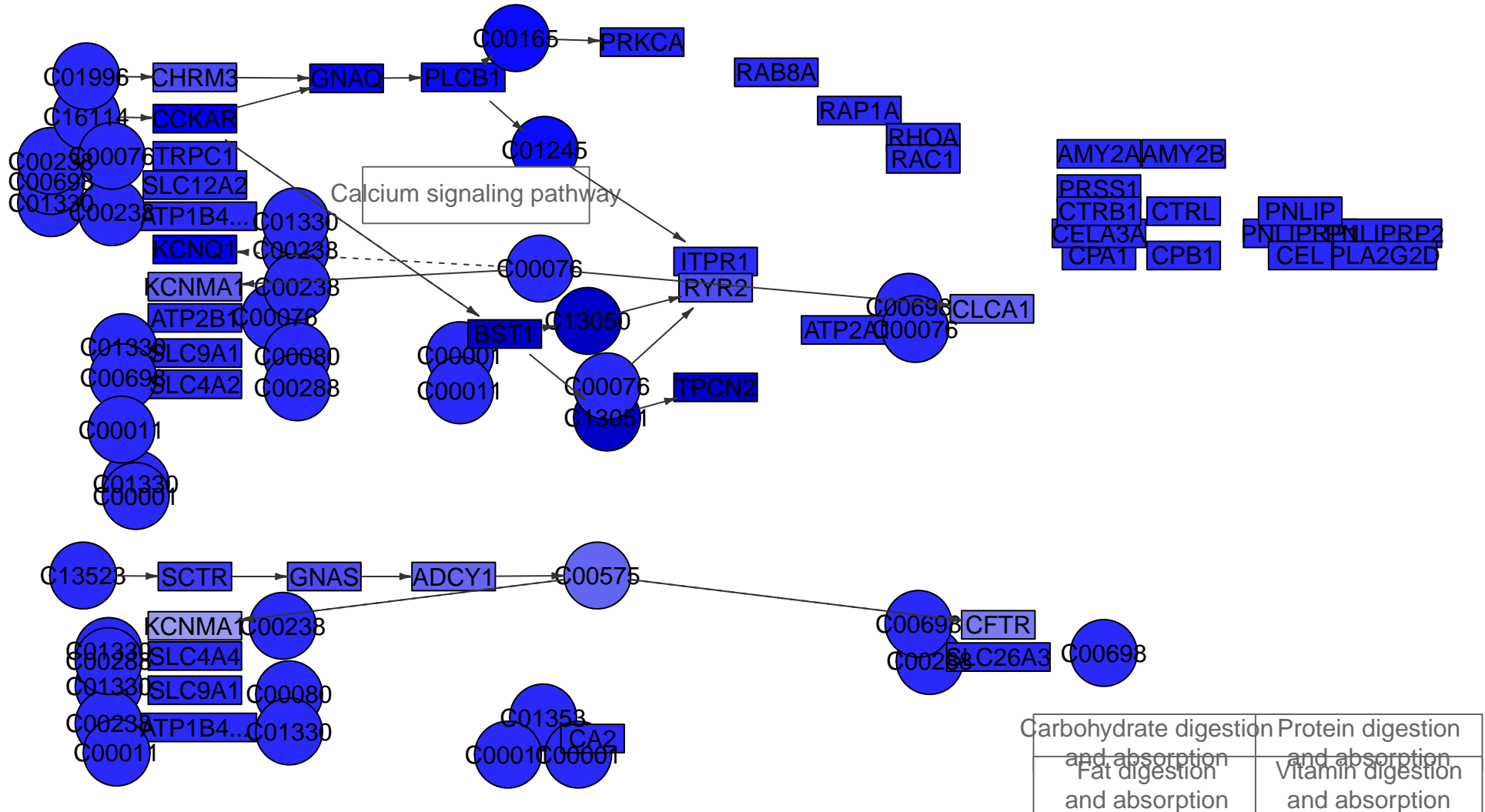

Pancreatic secretion
MPI-167



Tight junction

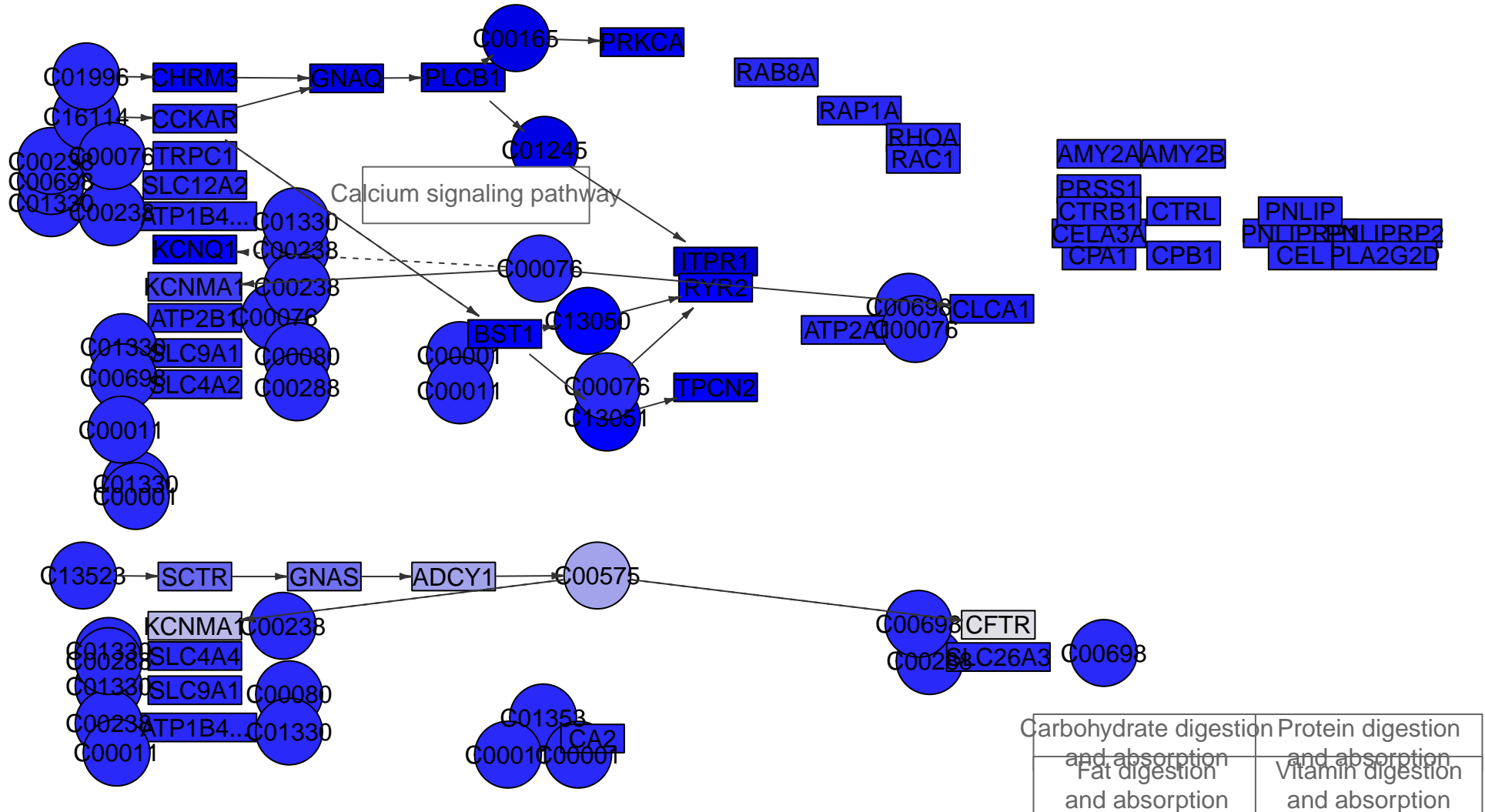

Pancreatic secretion
MPI-168



Tight junction

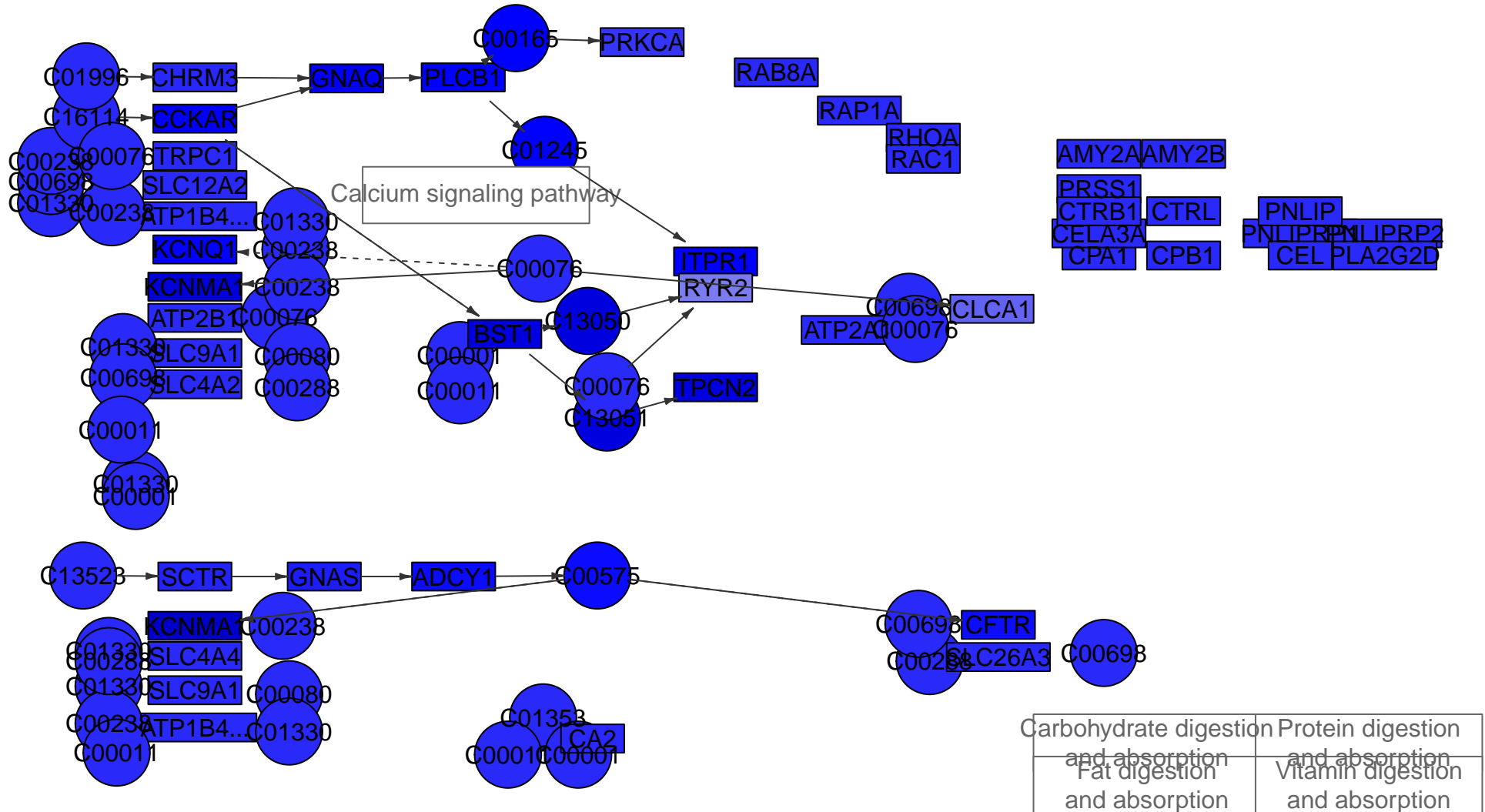

Pancreatic secretion
MPI-170



Tight junction

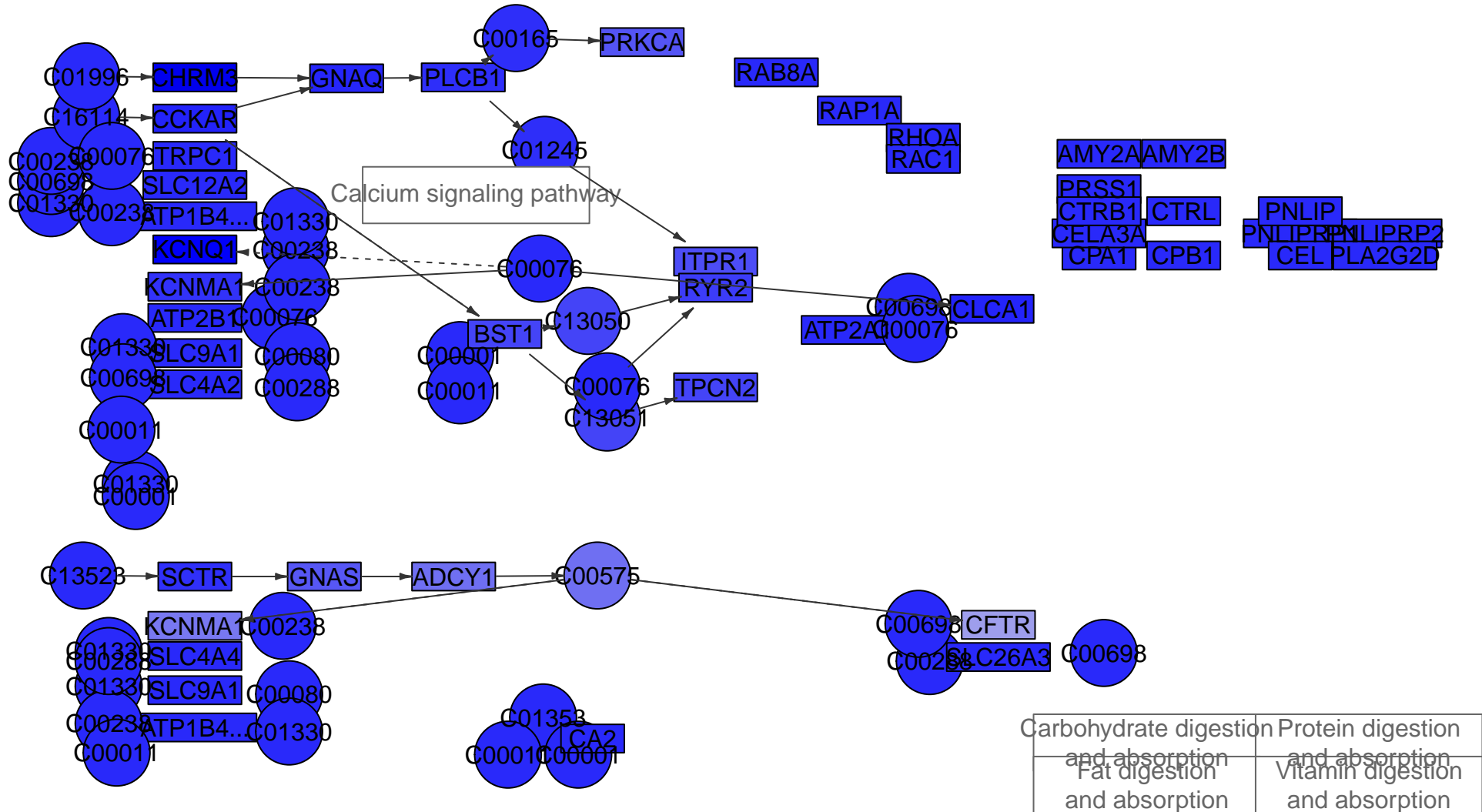

Pancreatic secretion
MPI-173



Tight junction

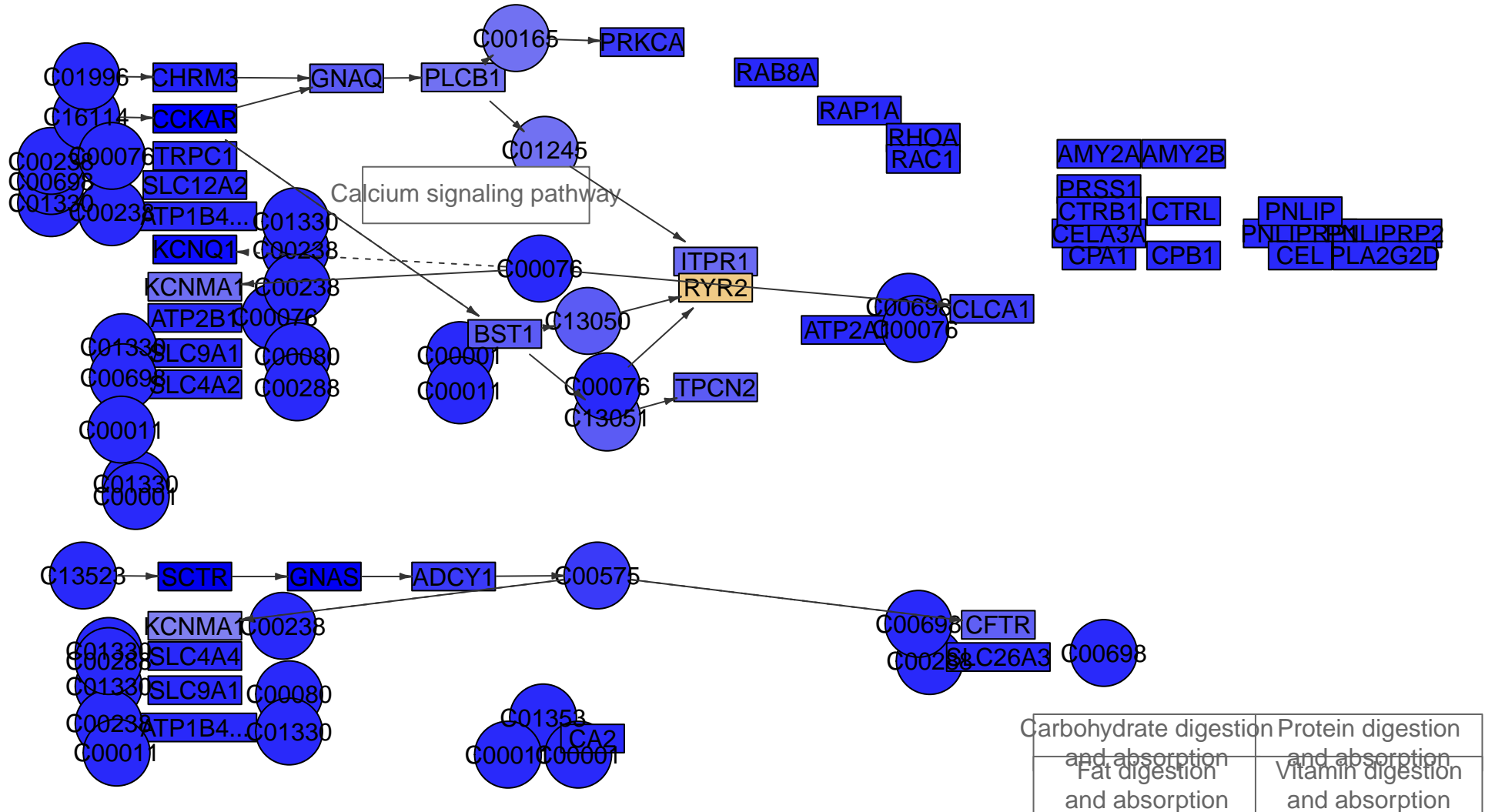

Carbohydrate digestion and absorption	Protein digestion and absorption
Fat digestion and absorption	Vitamin digestion and absorption

Pancreatic secretion
MPI-174

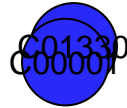

Tight junction

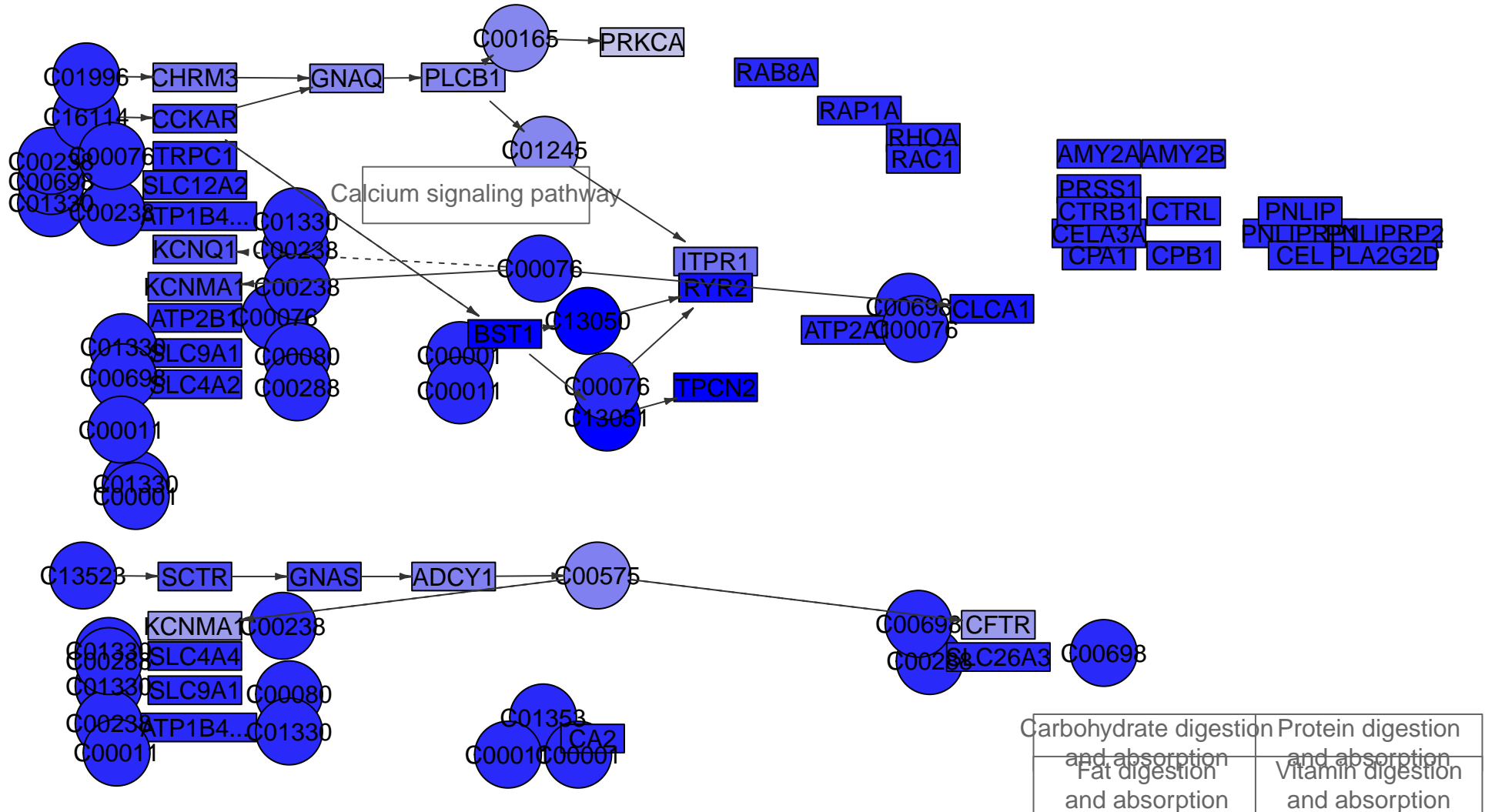

Pancreatic secretion
MPI-176



Tight junction

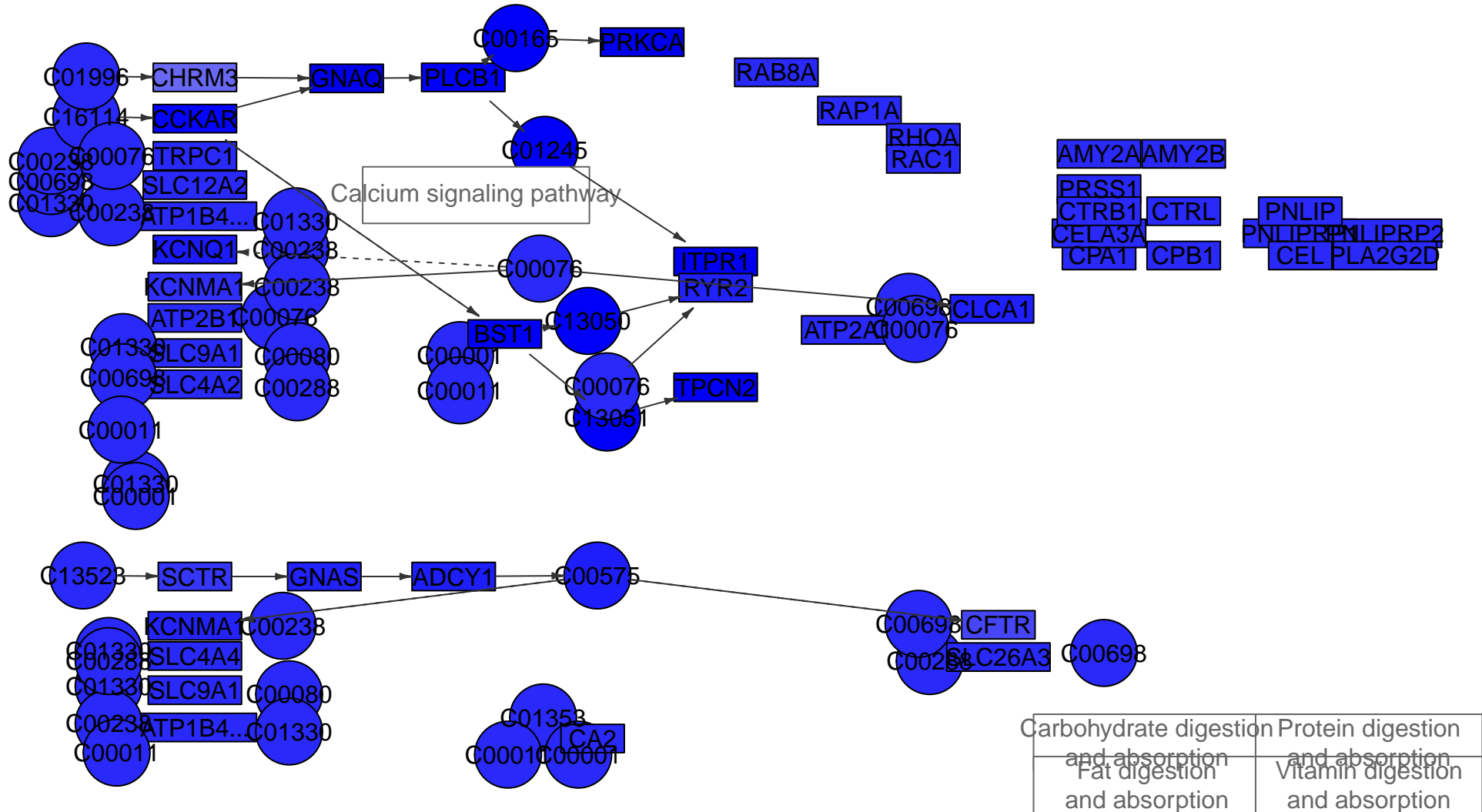

Pancreatic secretion
MPI-177



Tight junction

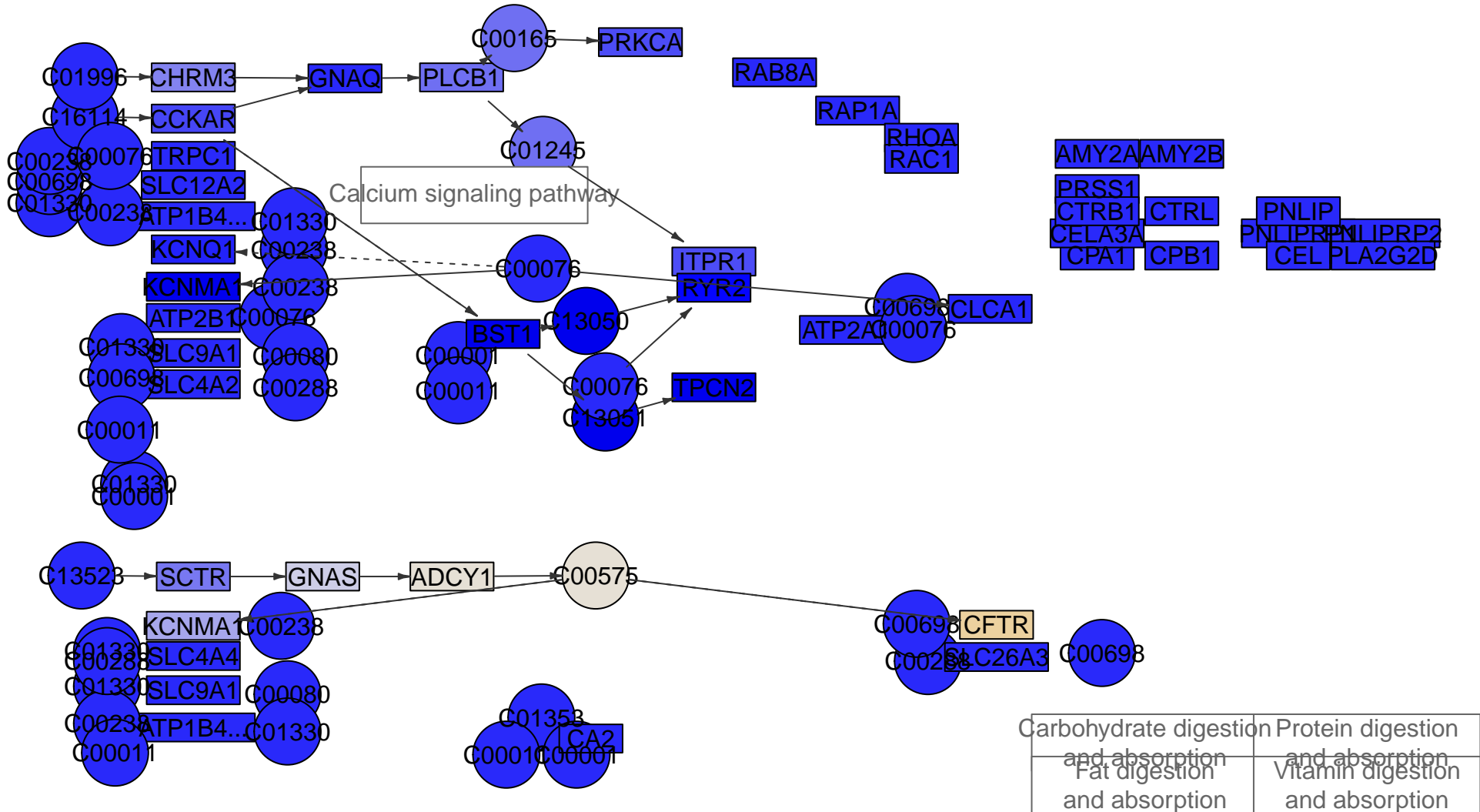

Pancreatic secretion
MPI-178



Tight junction

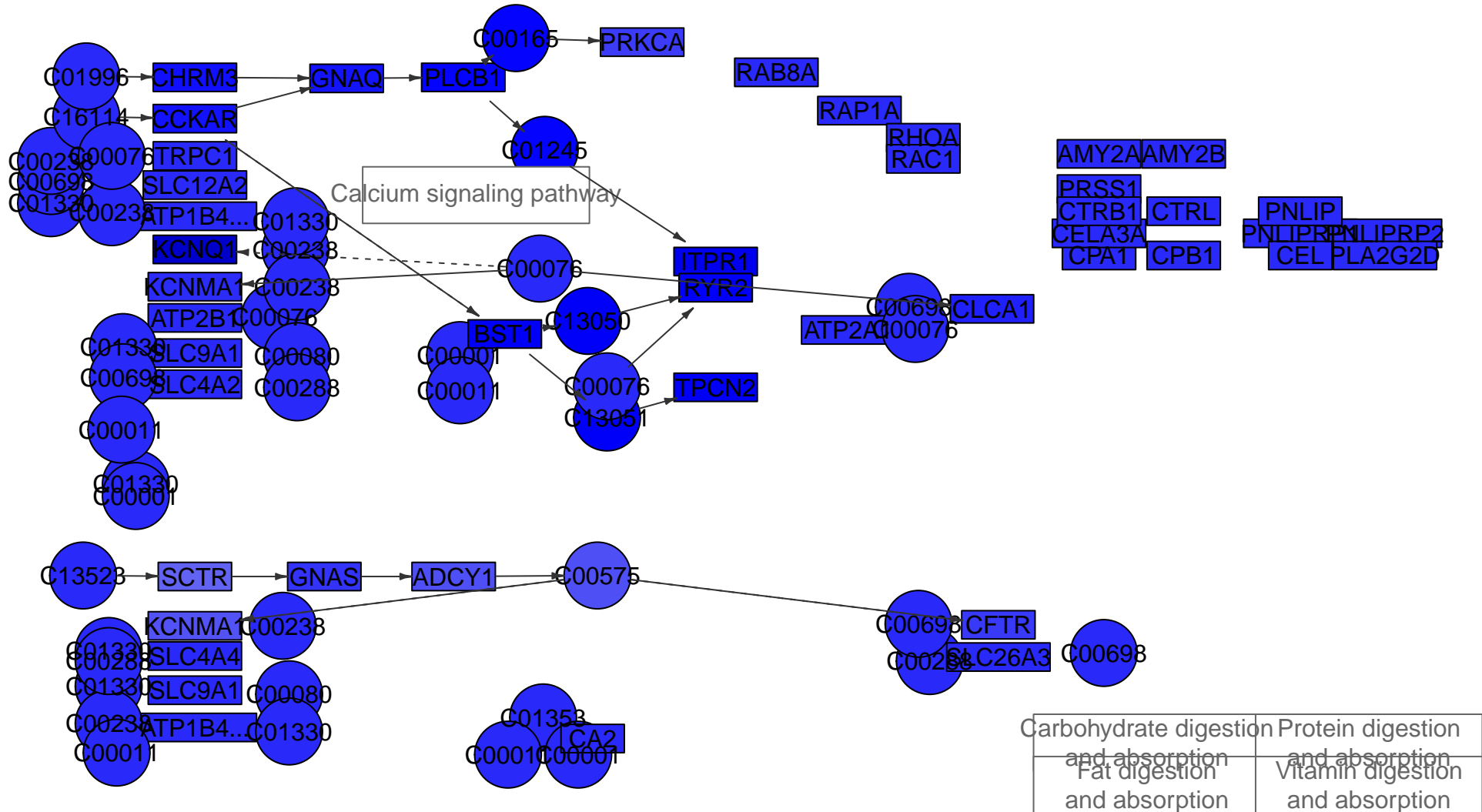

Pancreatic secretion
MPI-179



Tight junction

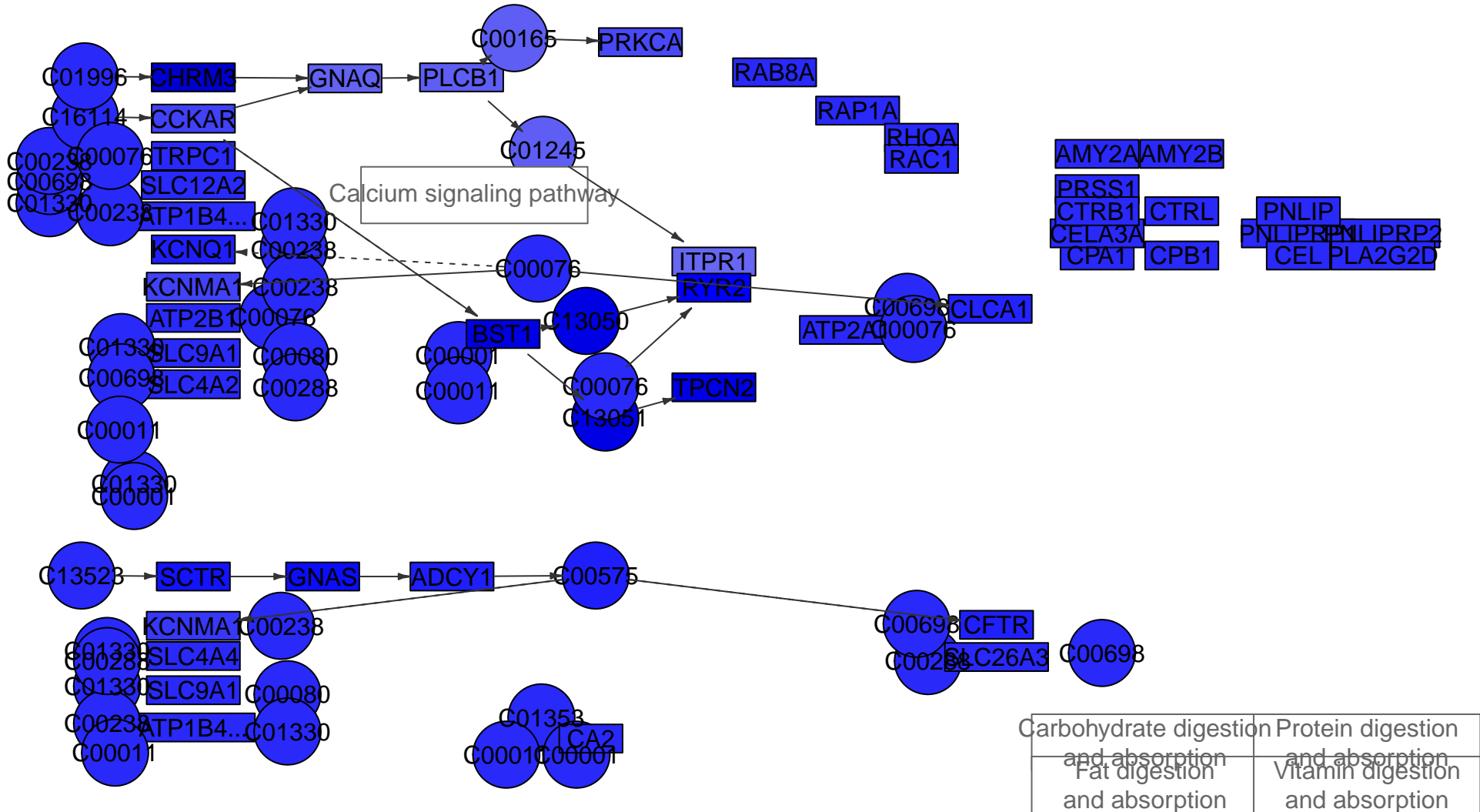

Pancreatic secretion
MPI-180



Tight junction

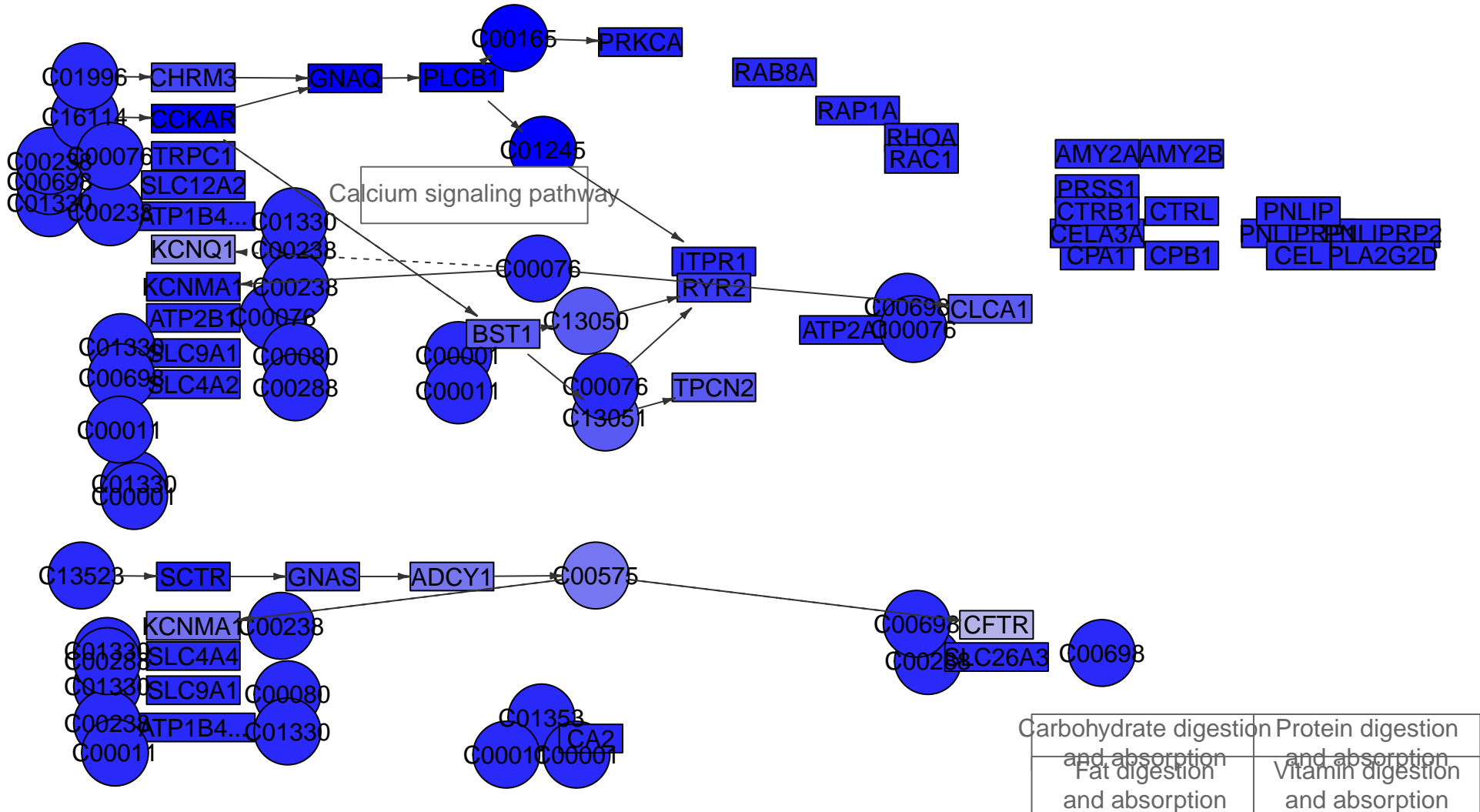

Pancreatic secretion
MPI-182



Tight junction

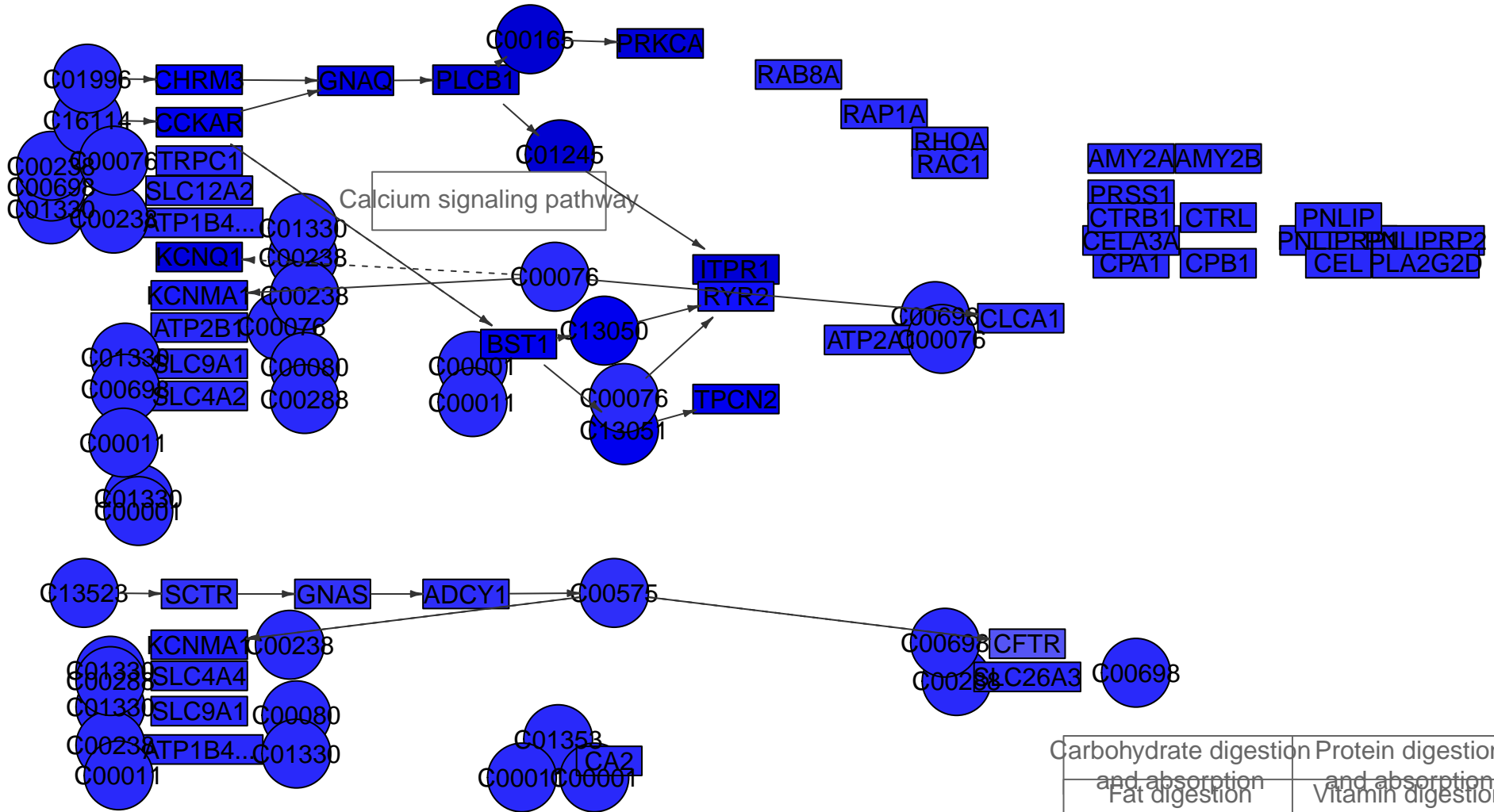

Pancreatic secretion
MPI-183



Tight junction

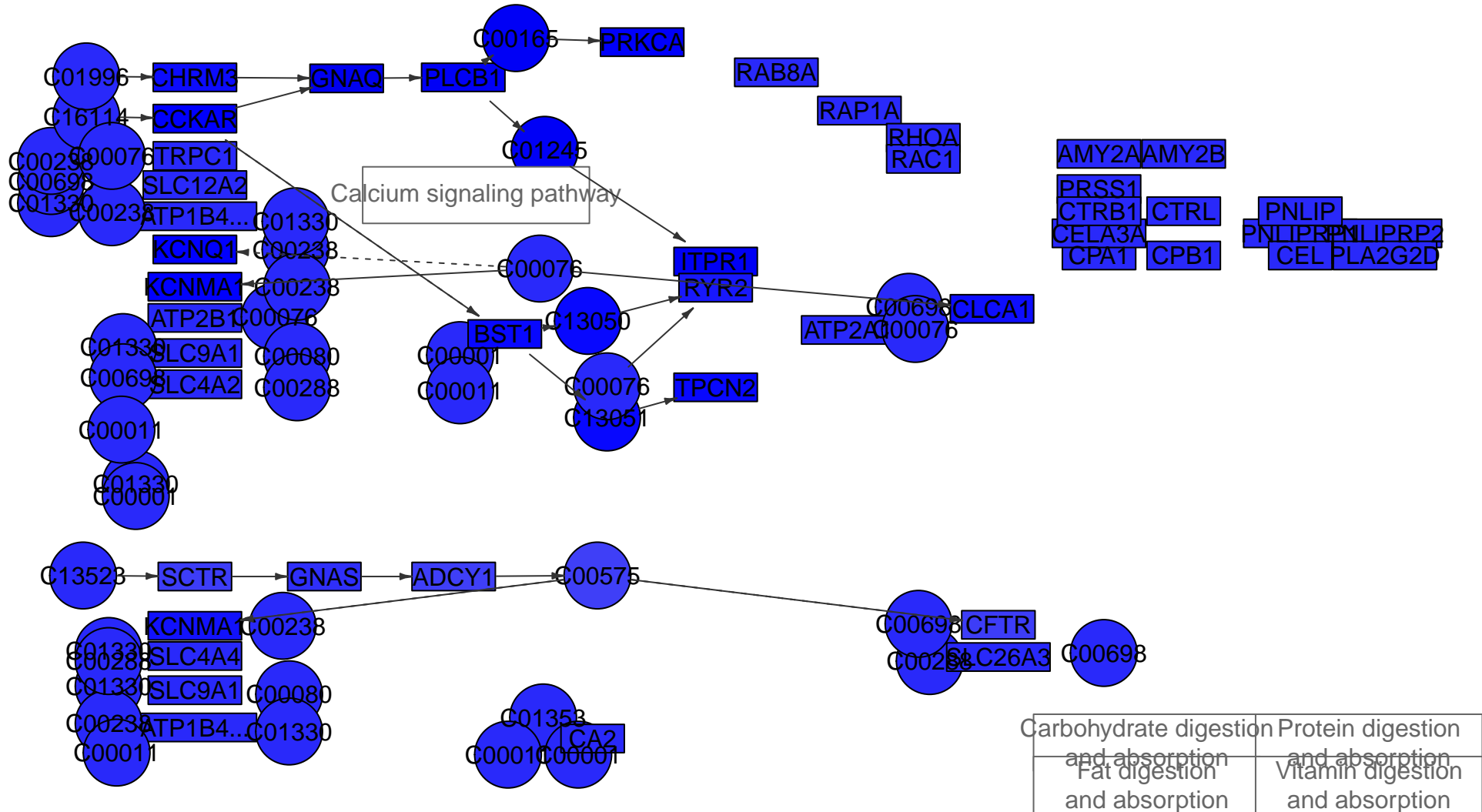

Carbohydrate digestion and absorption	Protein digestion and absorption
Fat digestion and absorption	Vitamin digestion and absorption

Pancreatic secretion
MPI-184

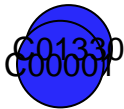

Tight junction

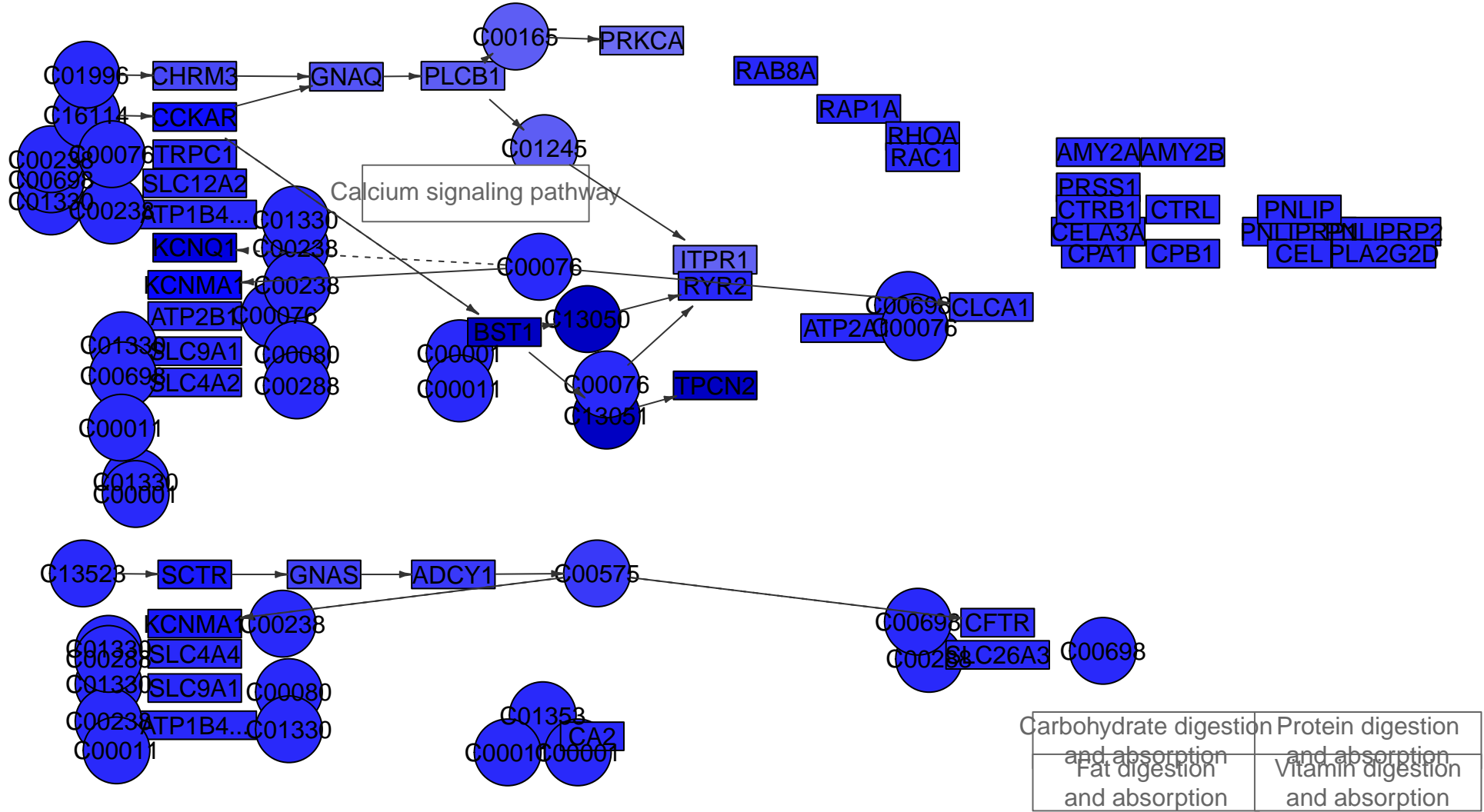

Pancreatic secretion
MPI-185



Tight junction

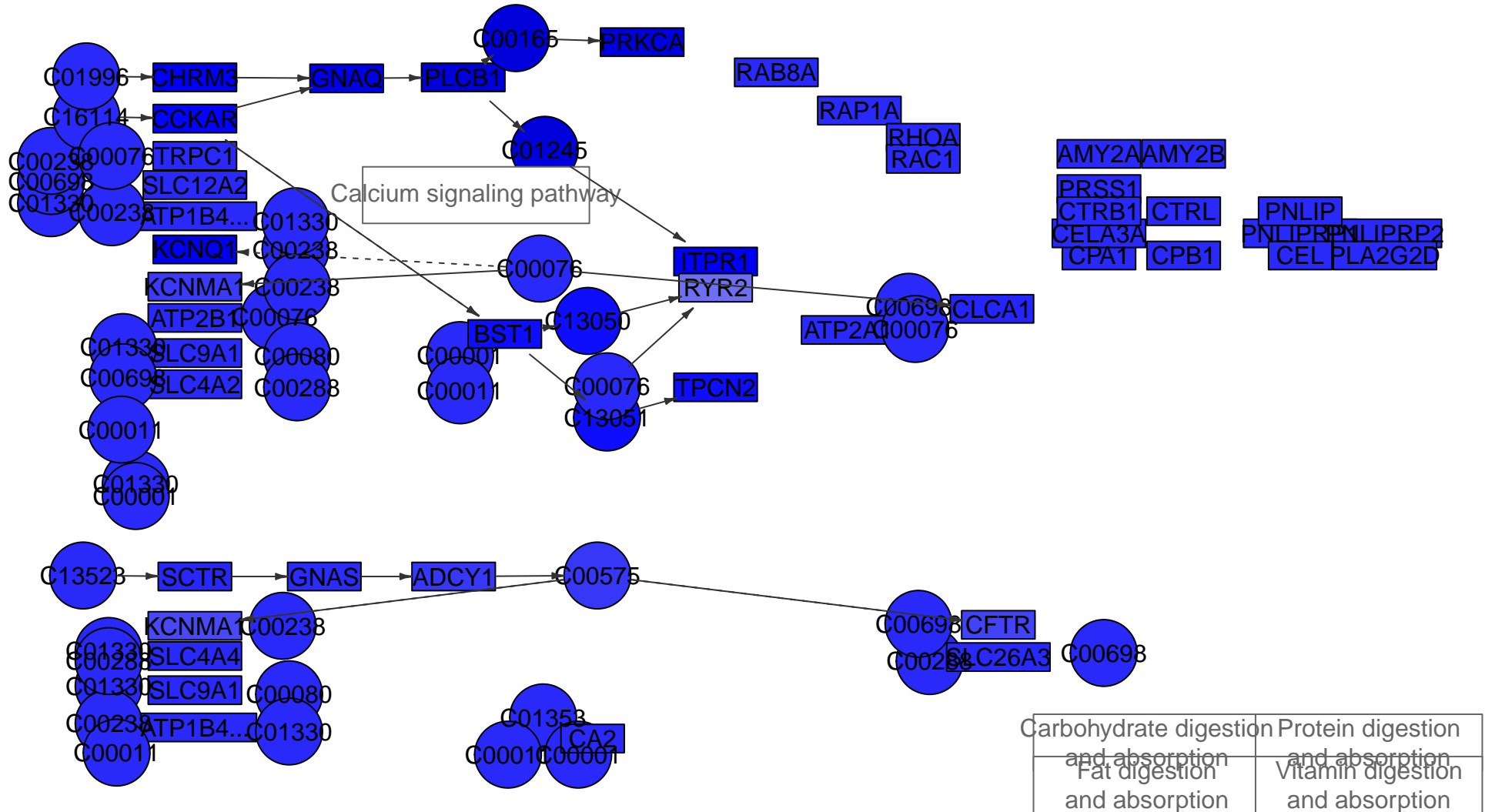

Pancreatic secretion
MPI-186



Tight junction

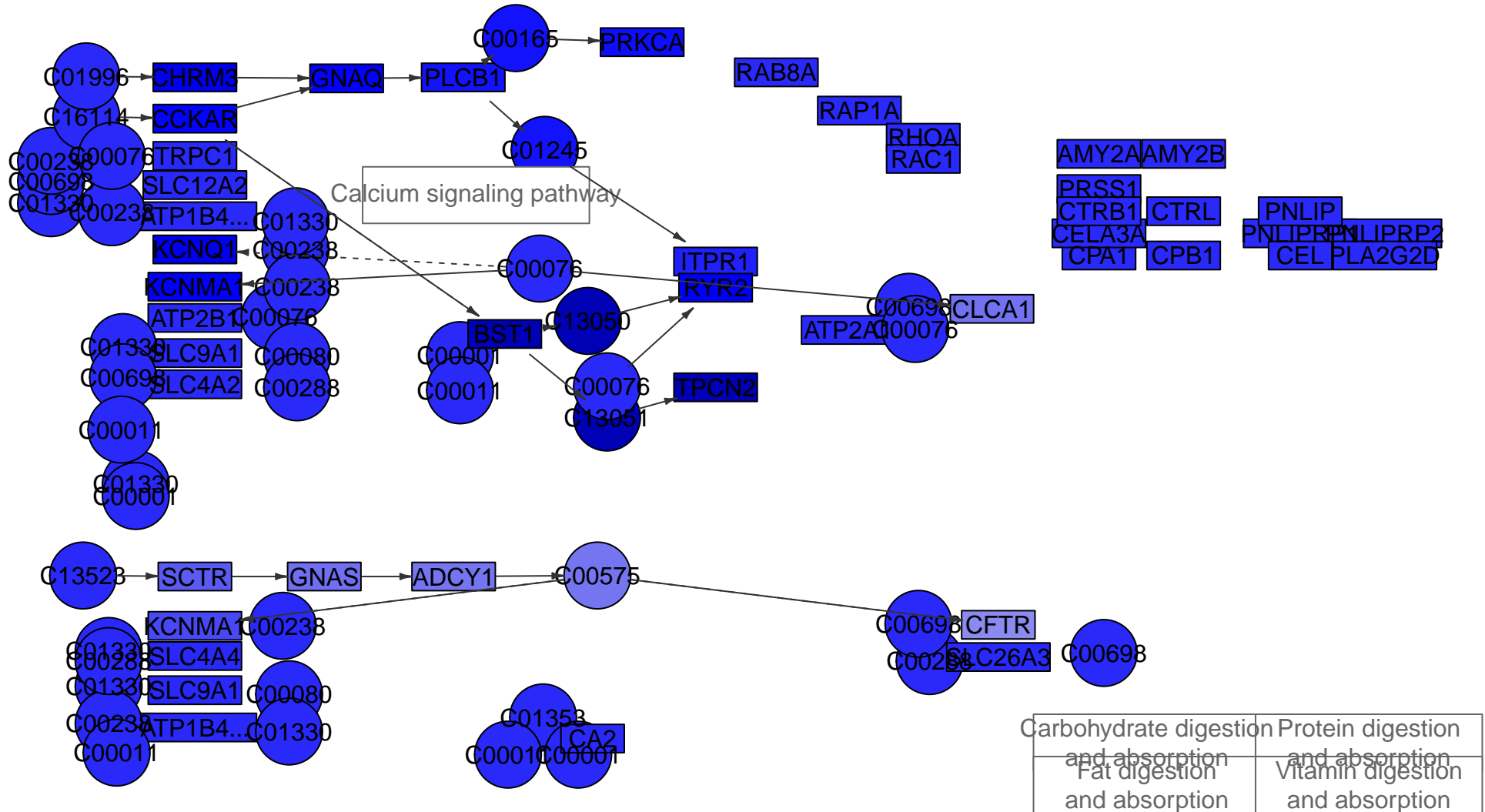

Pancreatic secretion
MPI-188



Tight junction

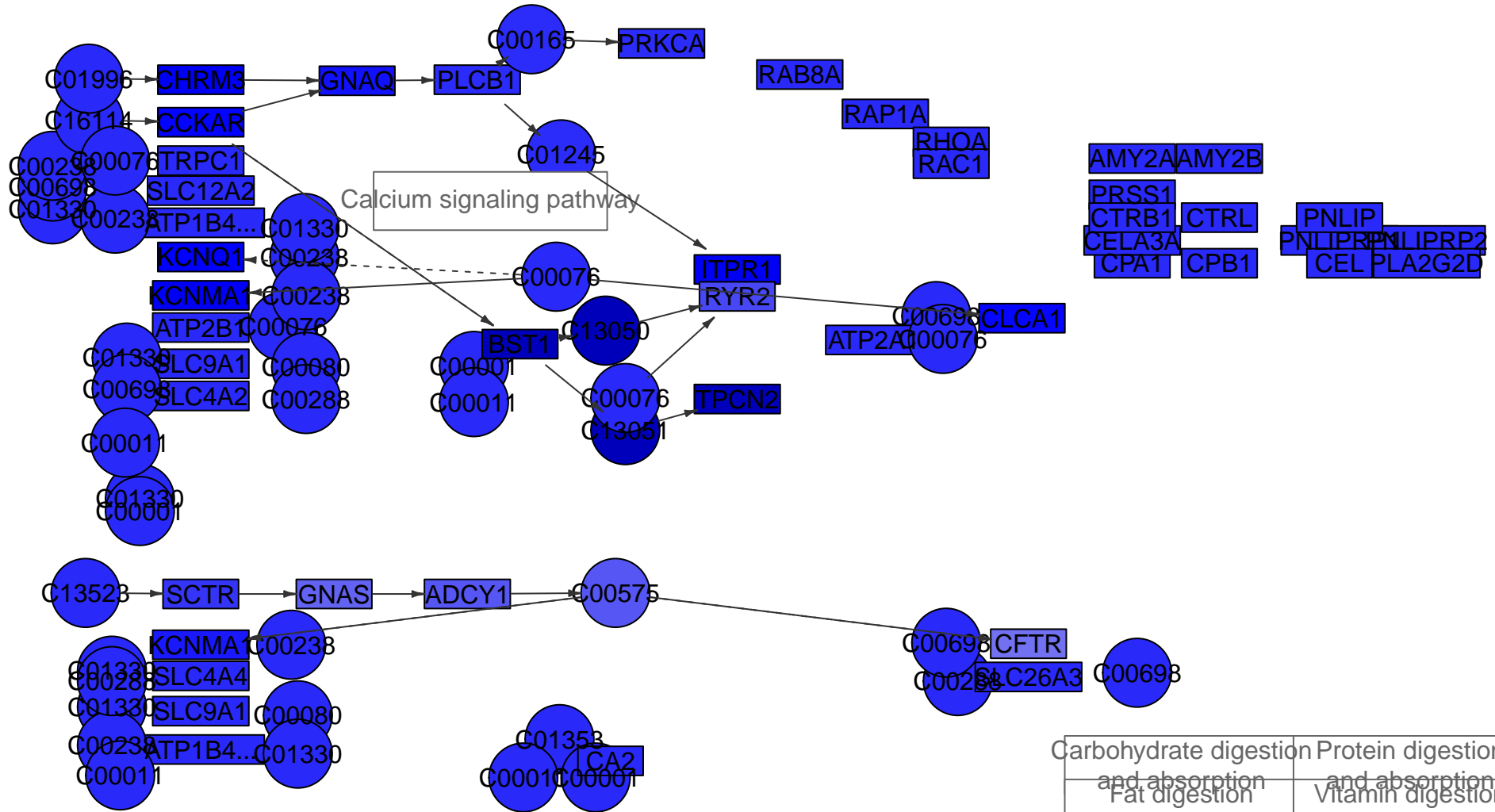

Pancreatic secretion
MPI-189



Tight junction

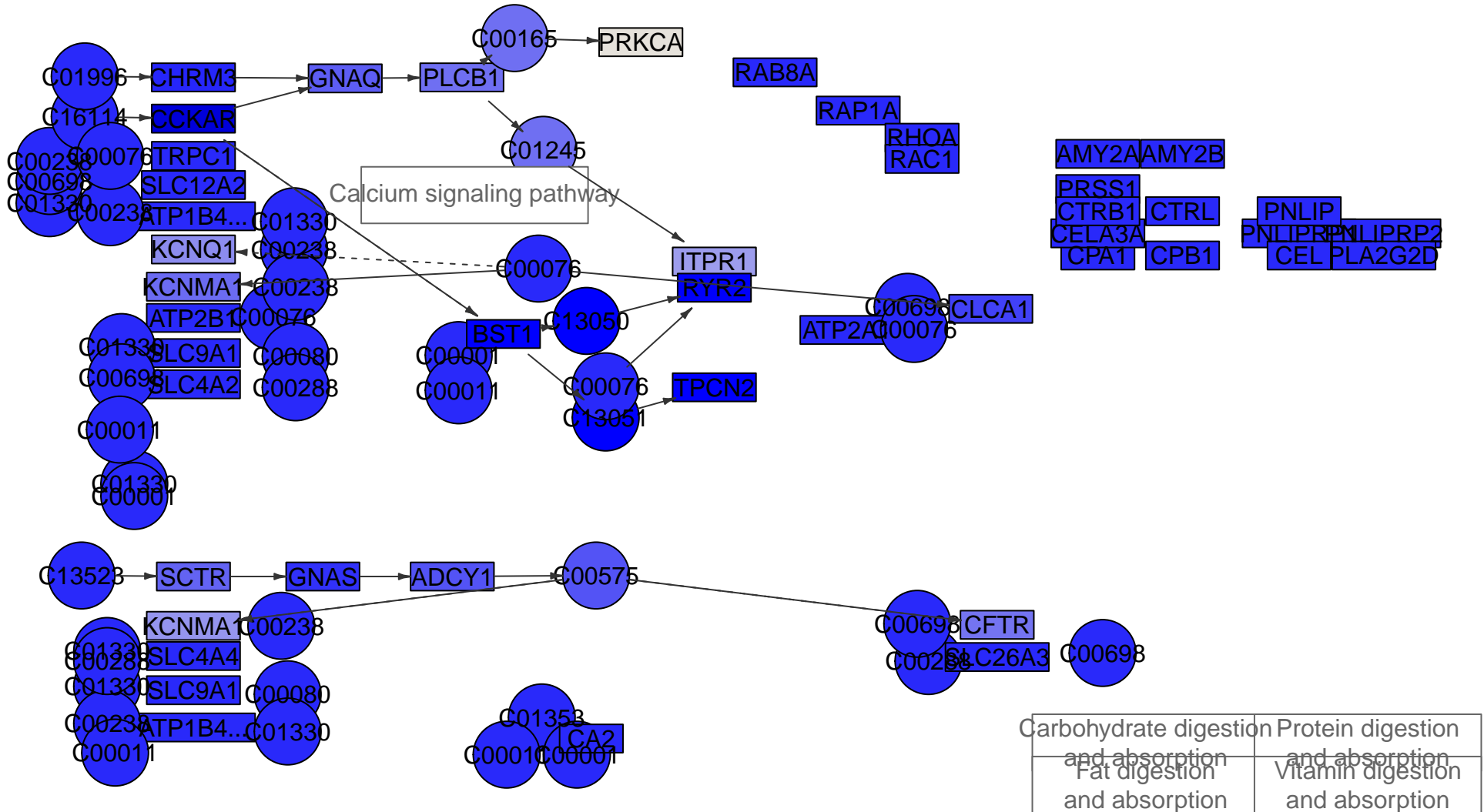

Pancreatic secretion
MPI-190



Tight junction

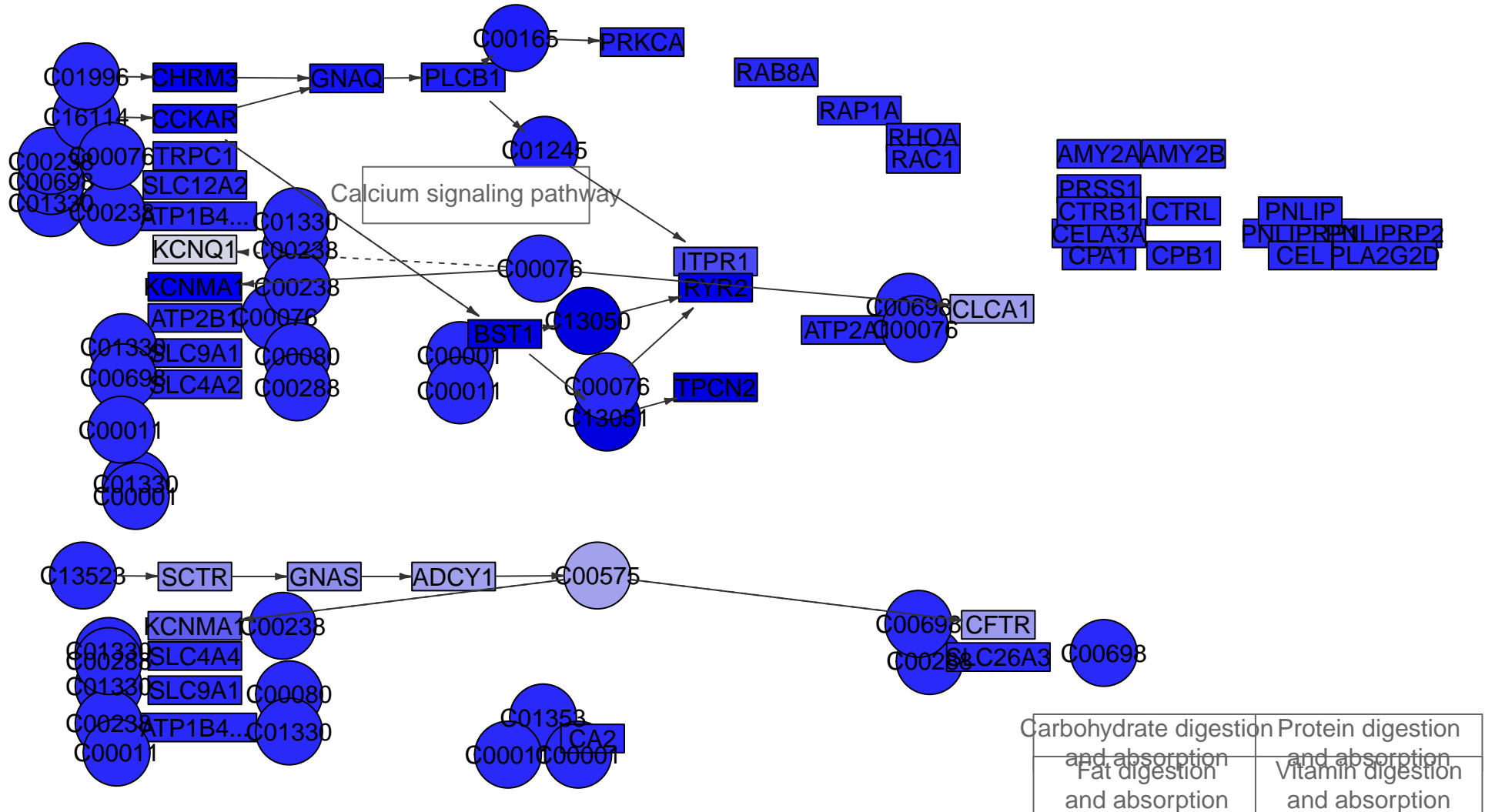

Pancreatic secretion
MPI-191

Tight junction

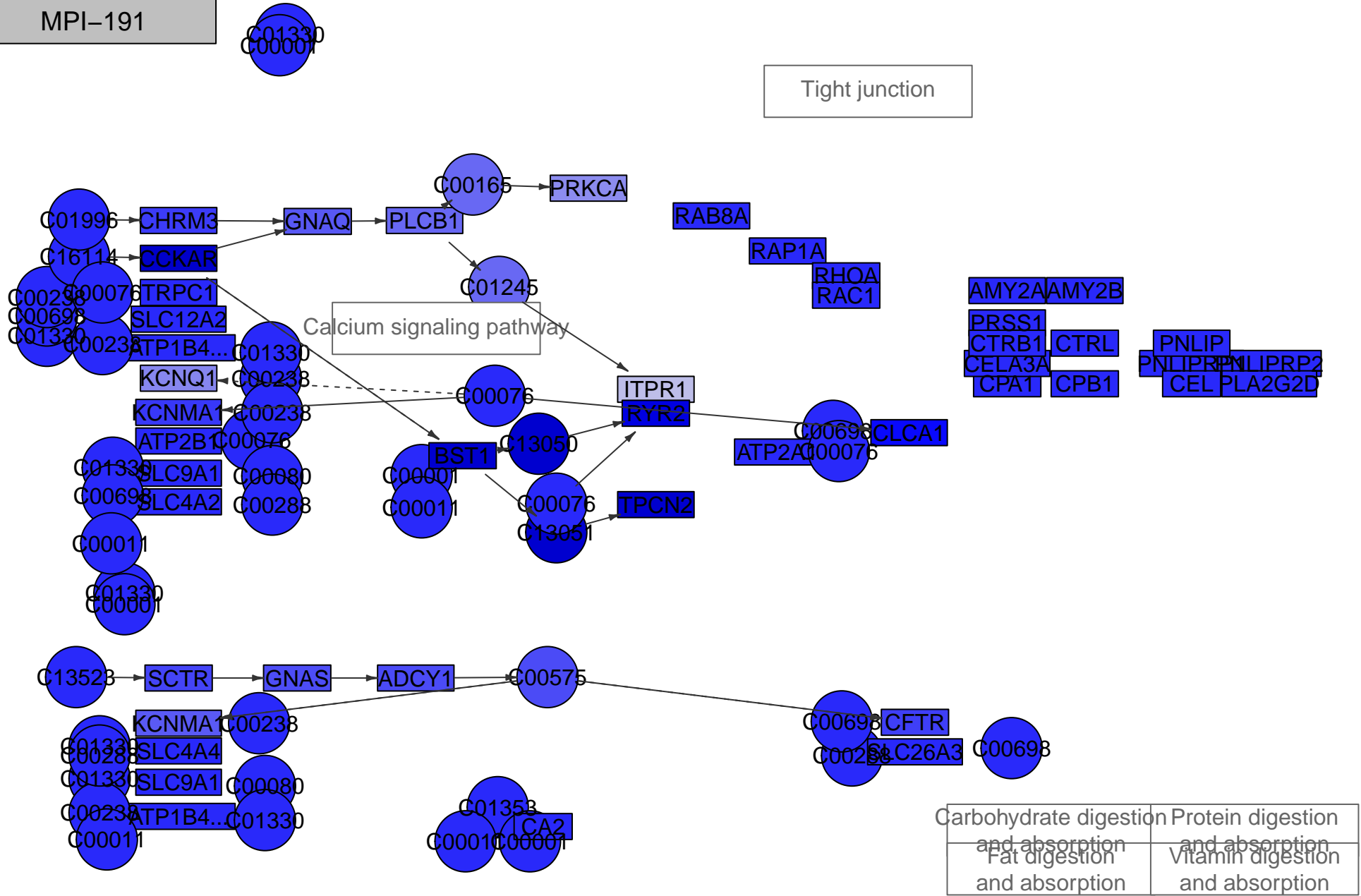

Pancreatic secretion
MPI-192



Tight junction

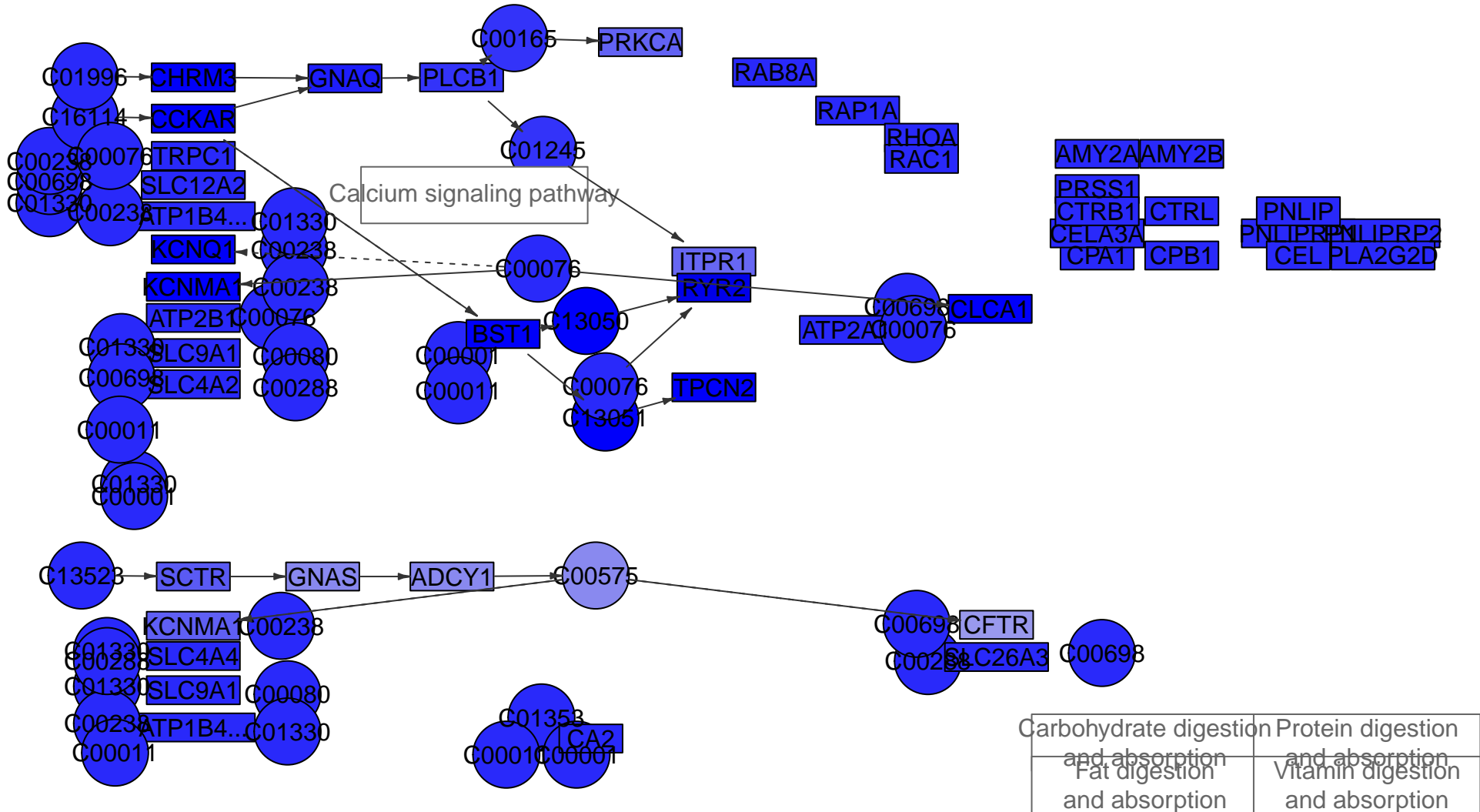

Pancreatic secretion
MPI-194



Tight junction

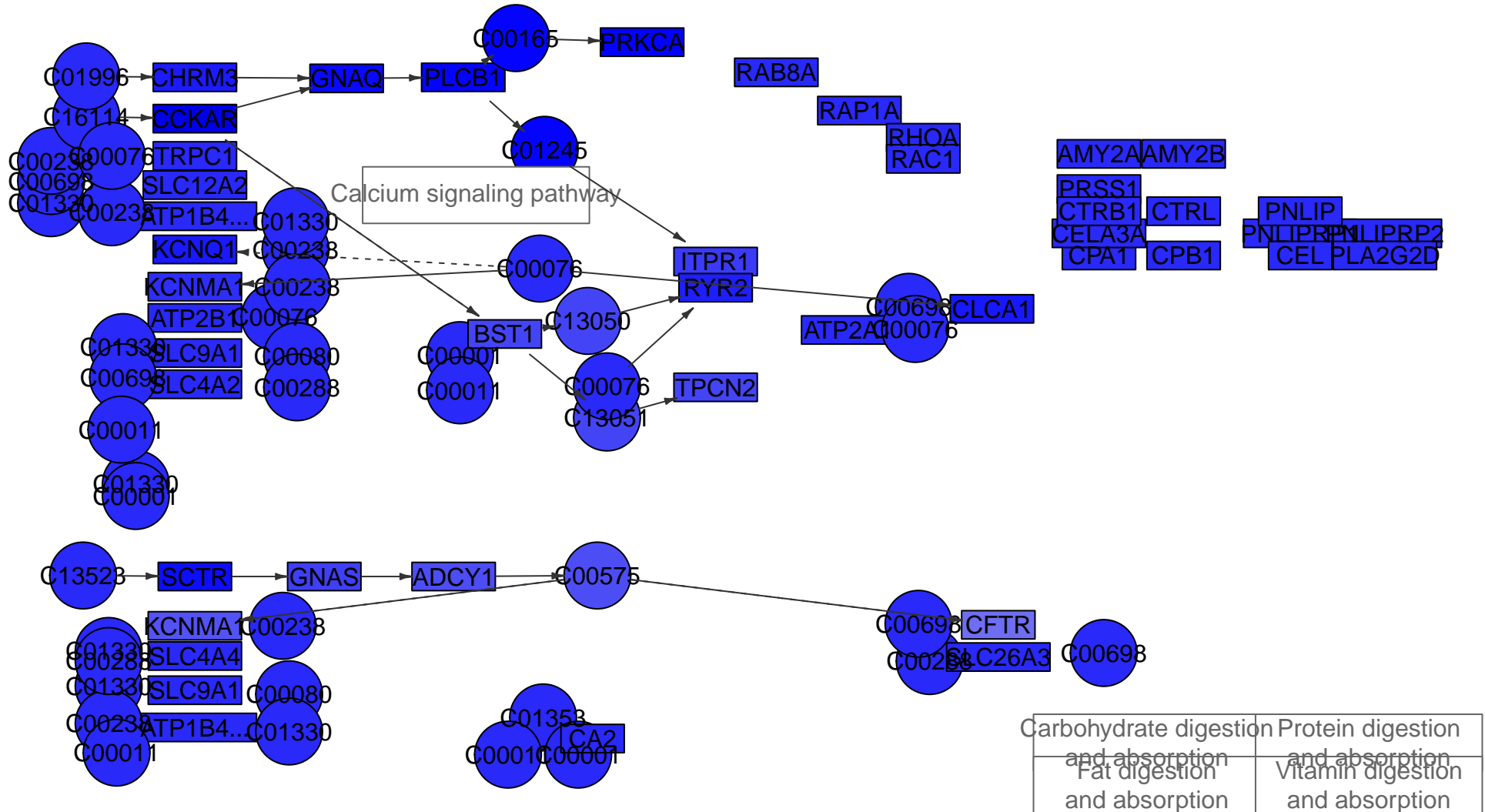

Pancreatic secretion
MPI-195



Tight junction

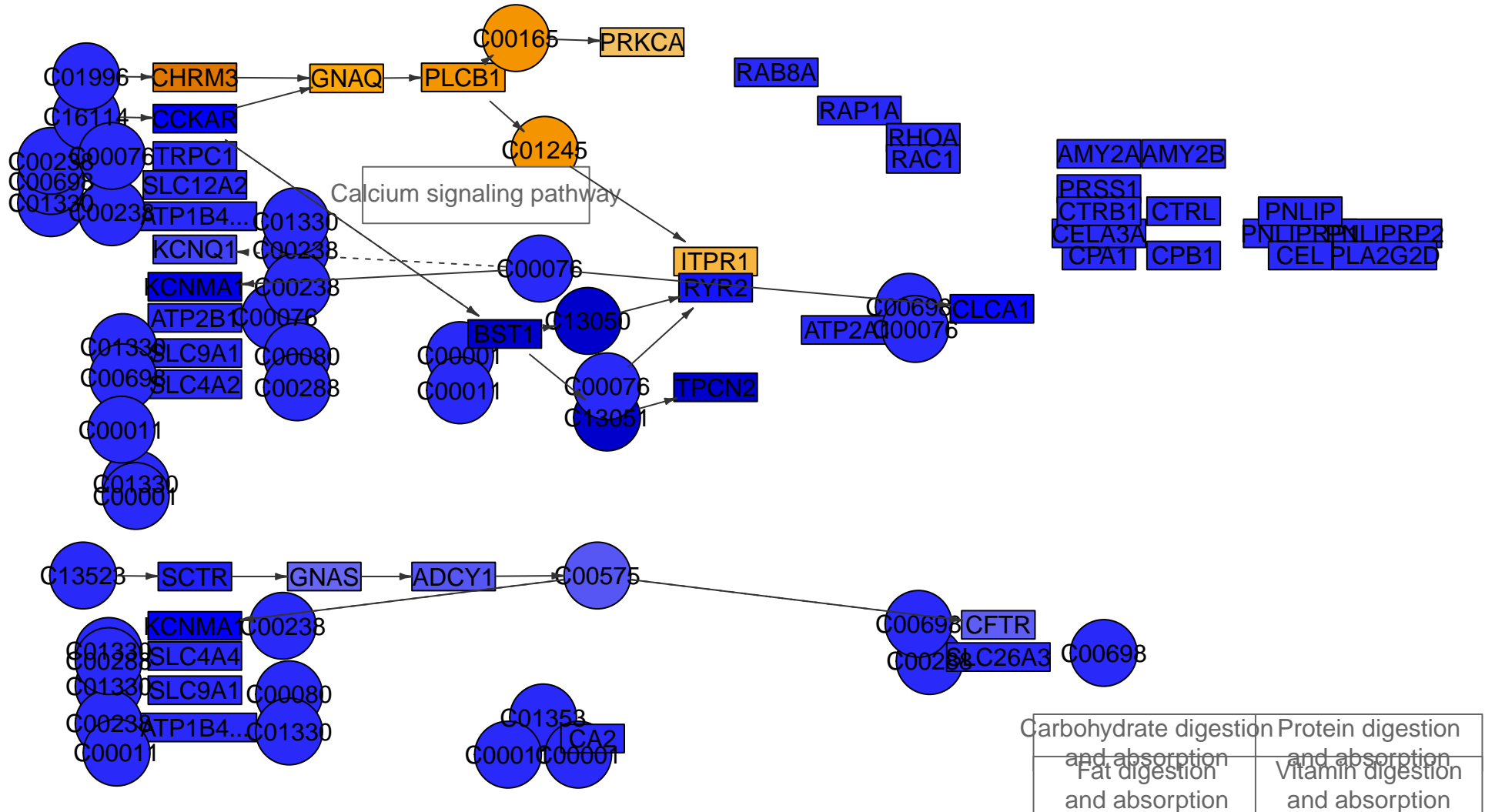

Pancreatic secretion
MPI-196



Tight junction

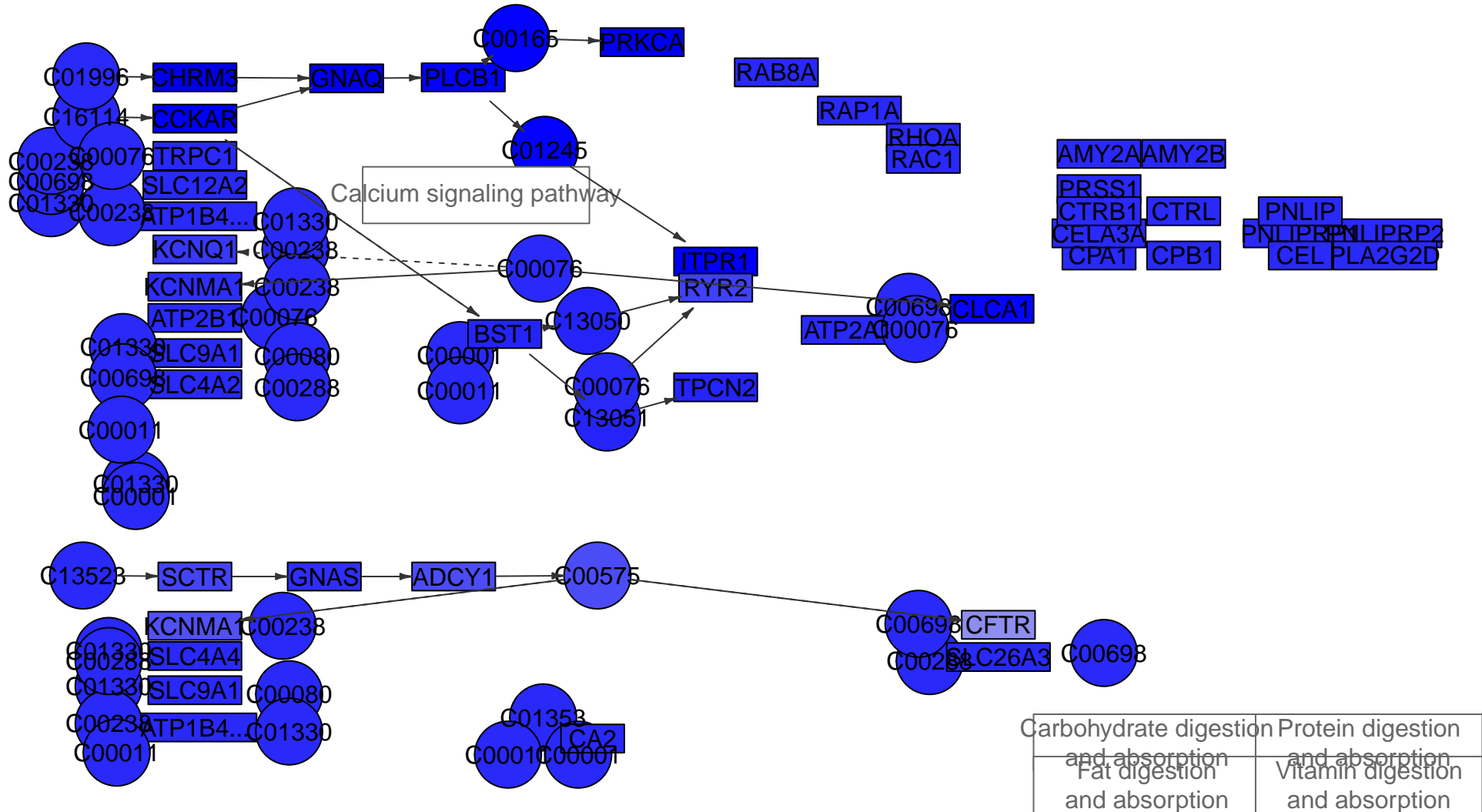

Pancreatic secretion
MPI-198



Tight junction

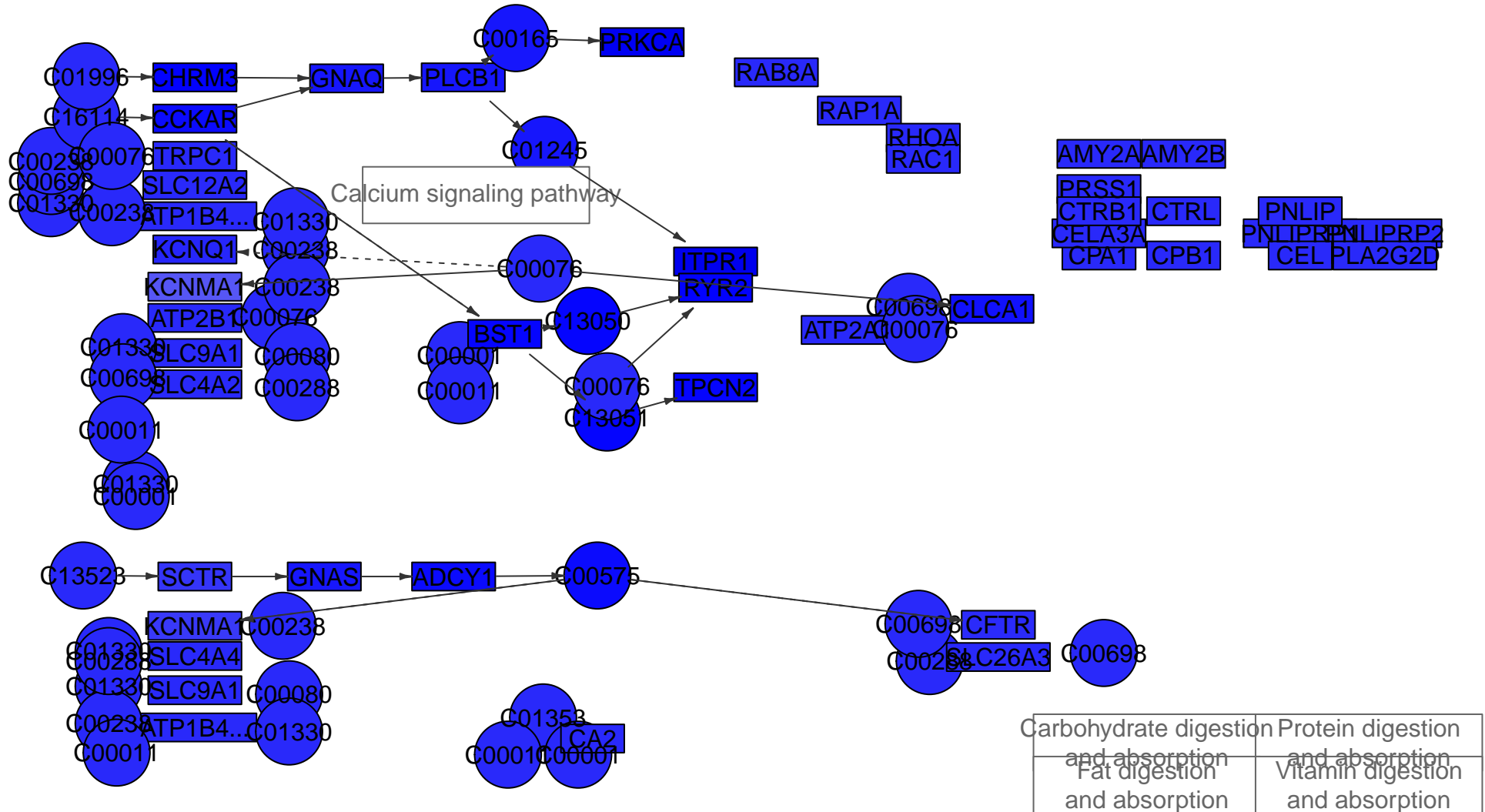

Pancreatic secretion
MPI-199



Tight junction

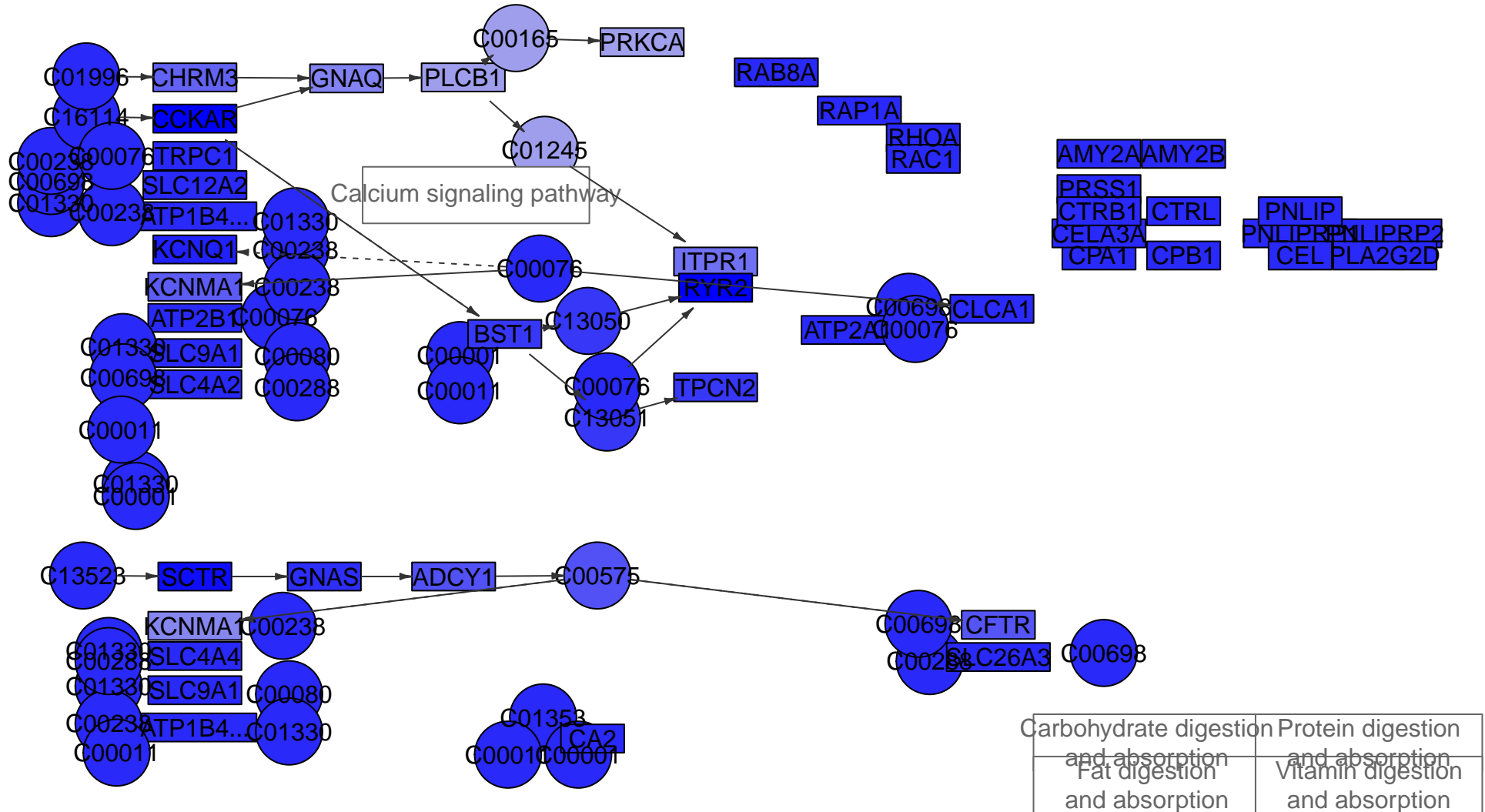

Pancreatic secretion
MPI-200



Tight junction

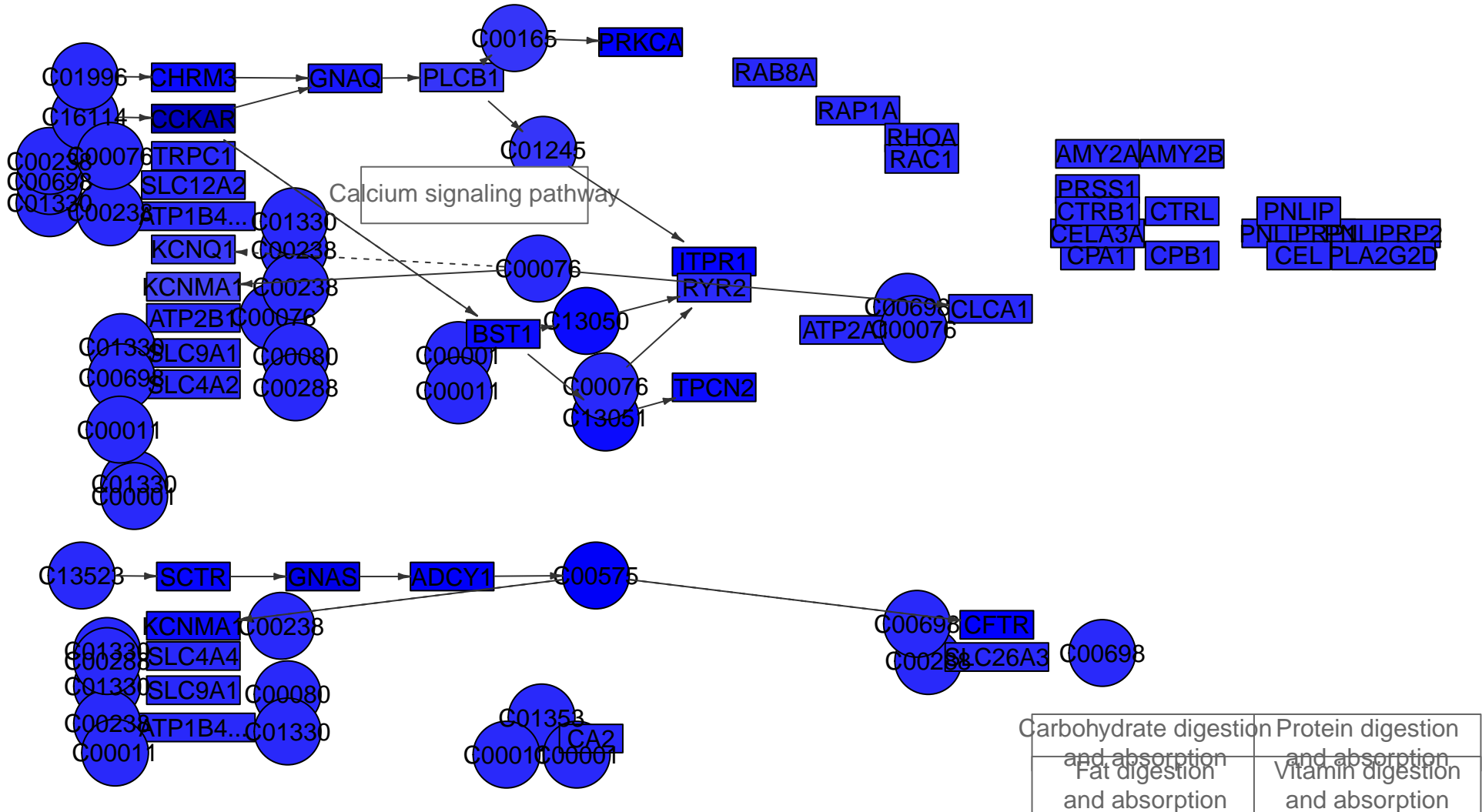

Pancreatic secretion
MPI-201

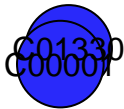

Tight junction

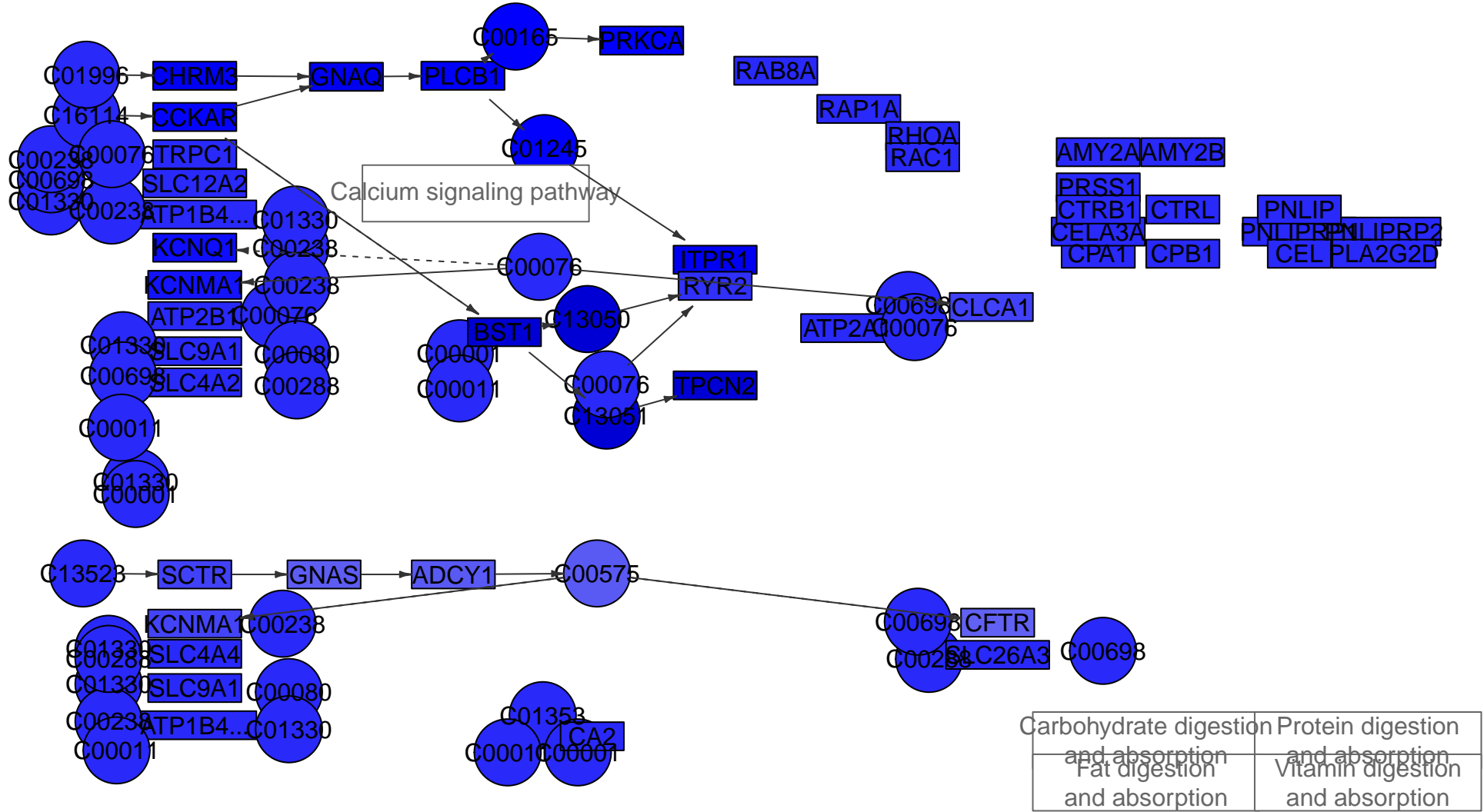

Carbohydrate digestion and absorption	Protein digestion and absorption
Fat digestion and absorption	Vitamin digestion and absorption

Pancreatic secretion
MPI-202



Tight junction

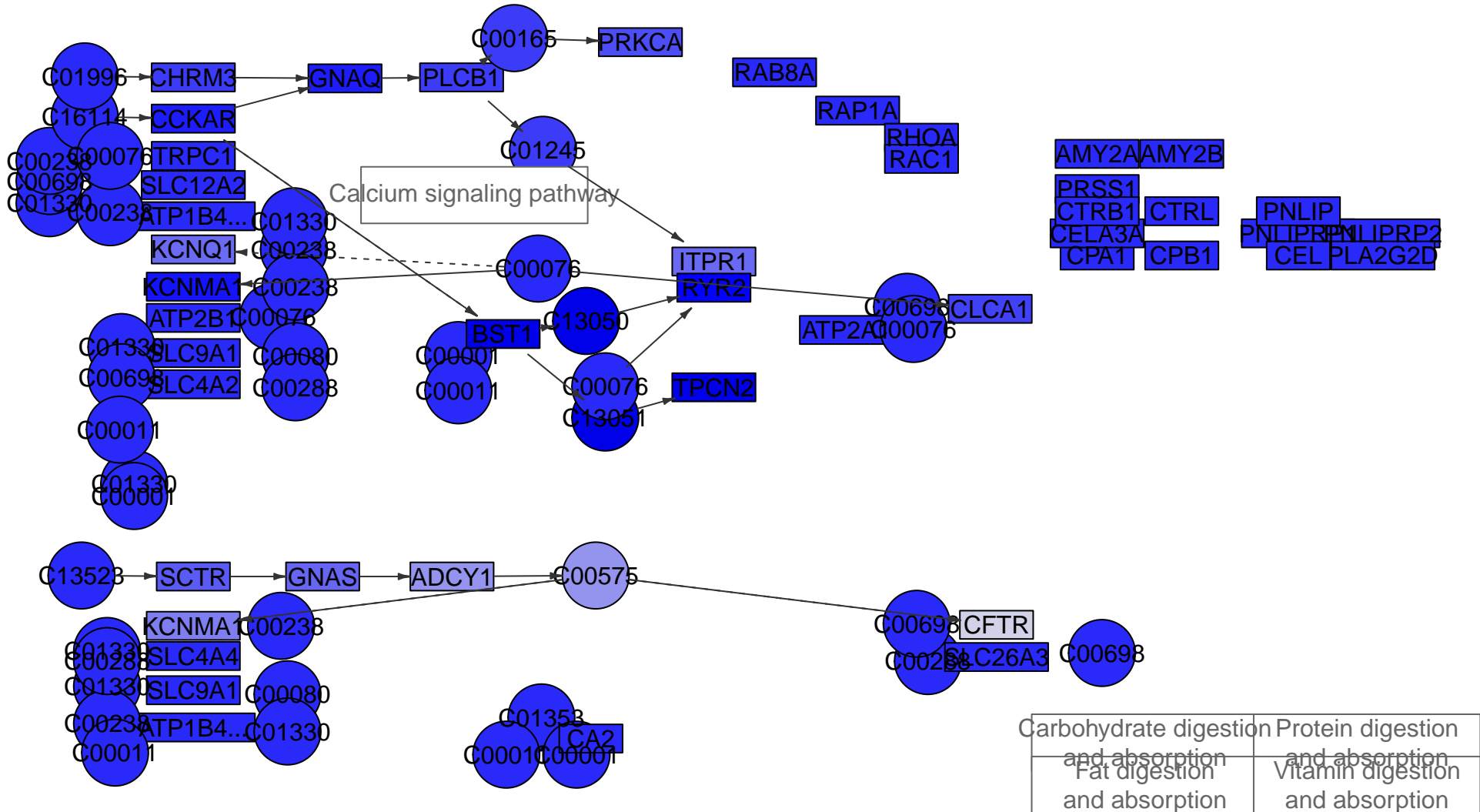

Pancreatic secretion
MPI-203

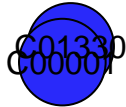

Tight junction

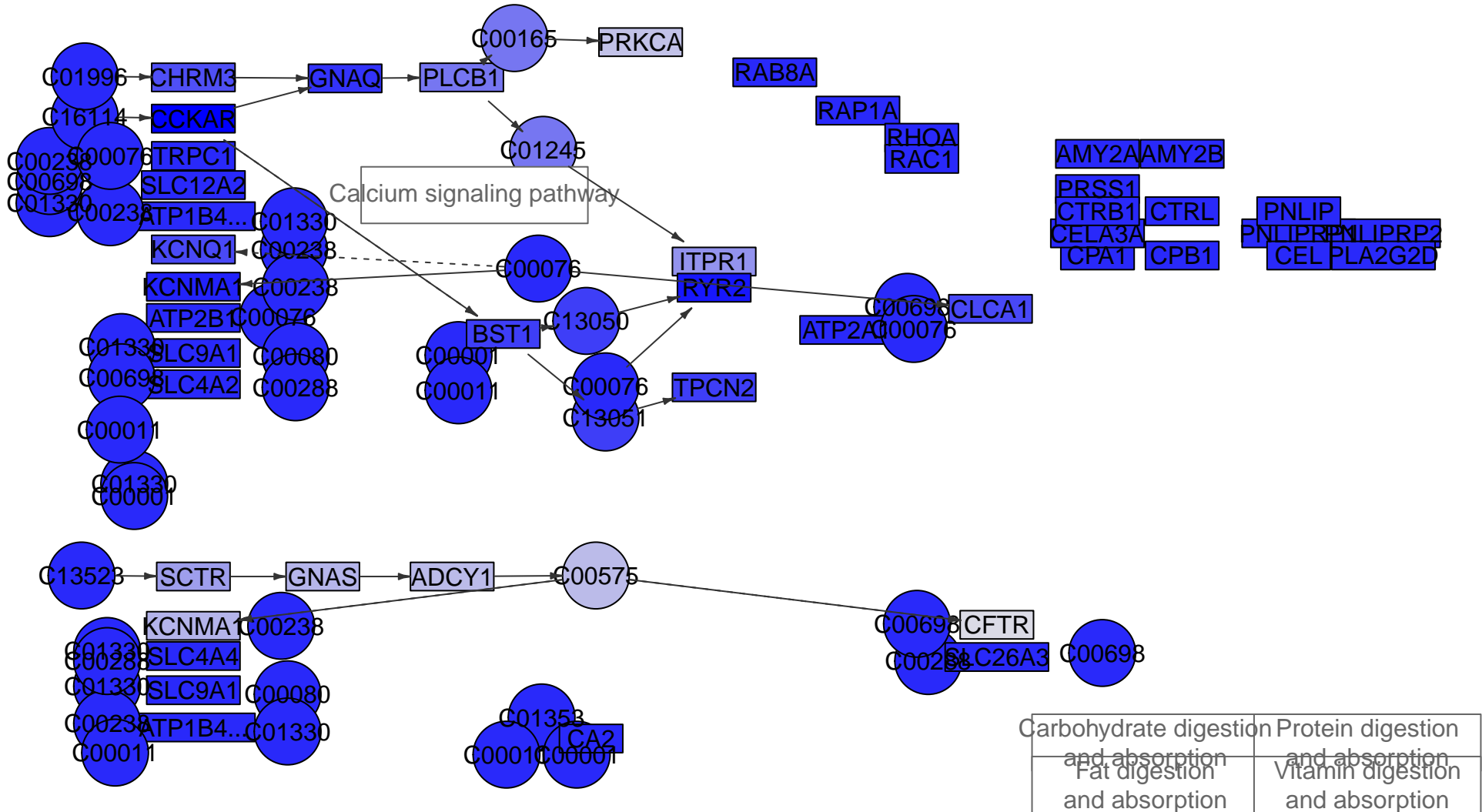

Pancreatic secretion
MPI-204

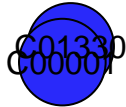

Tight junction

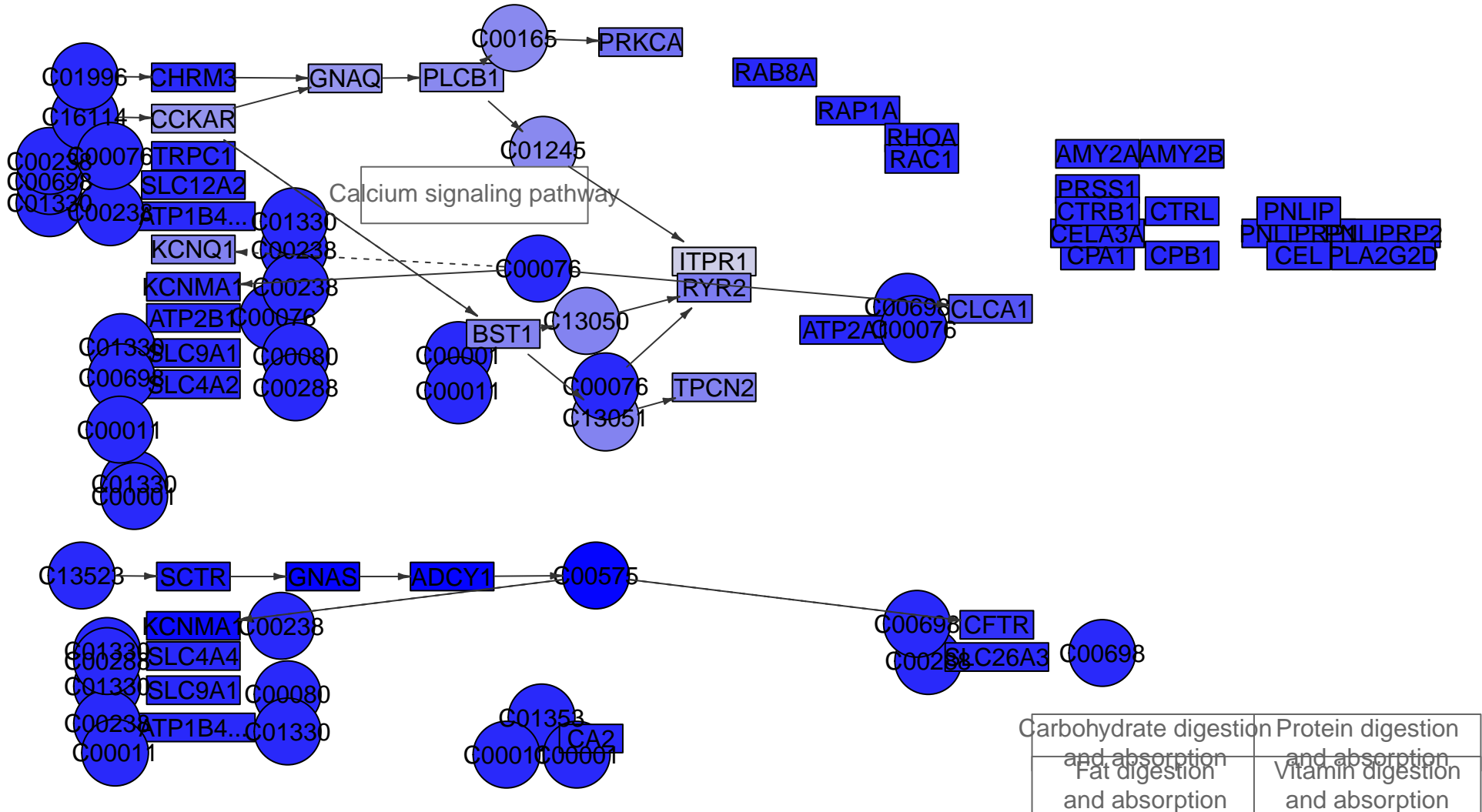

Pancreatic secretion
MPI-205



Tight junction

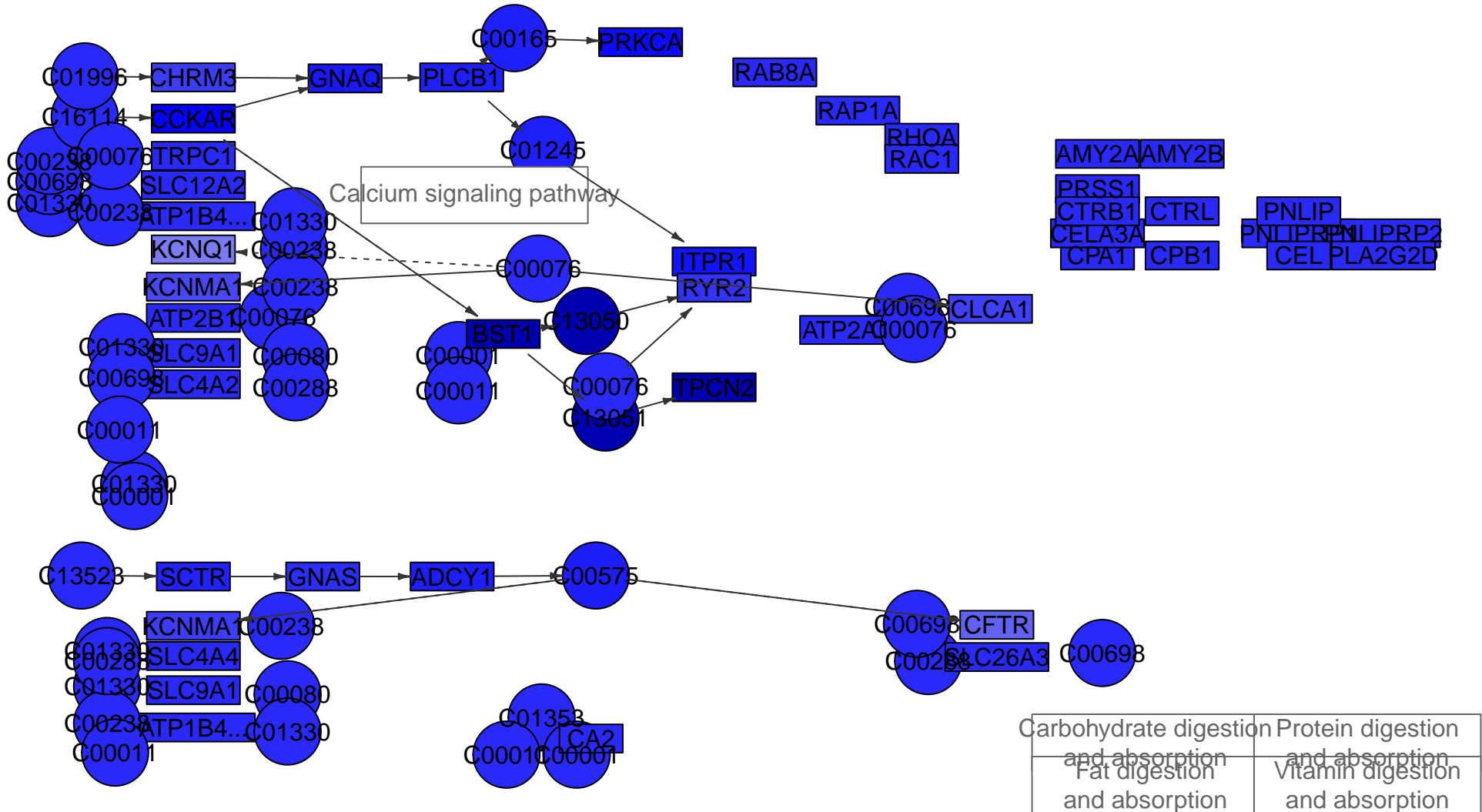

Pancreatic secretion
MPI-206



Tight junction

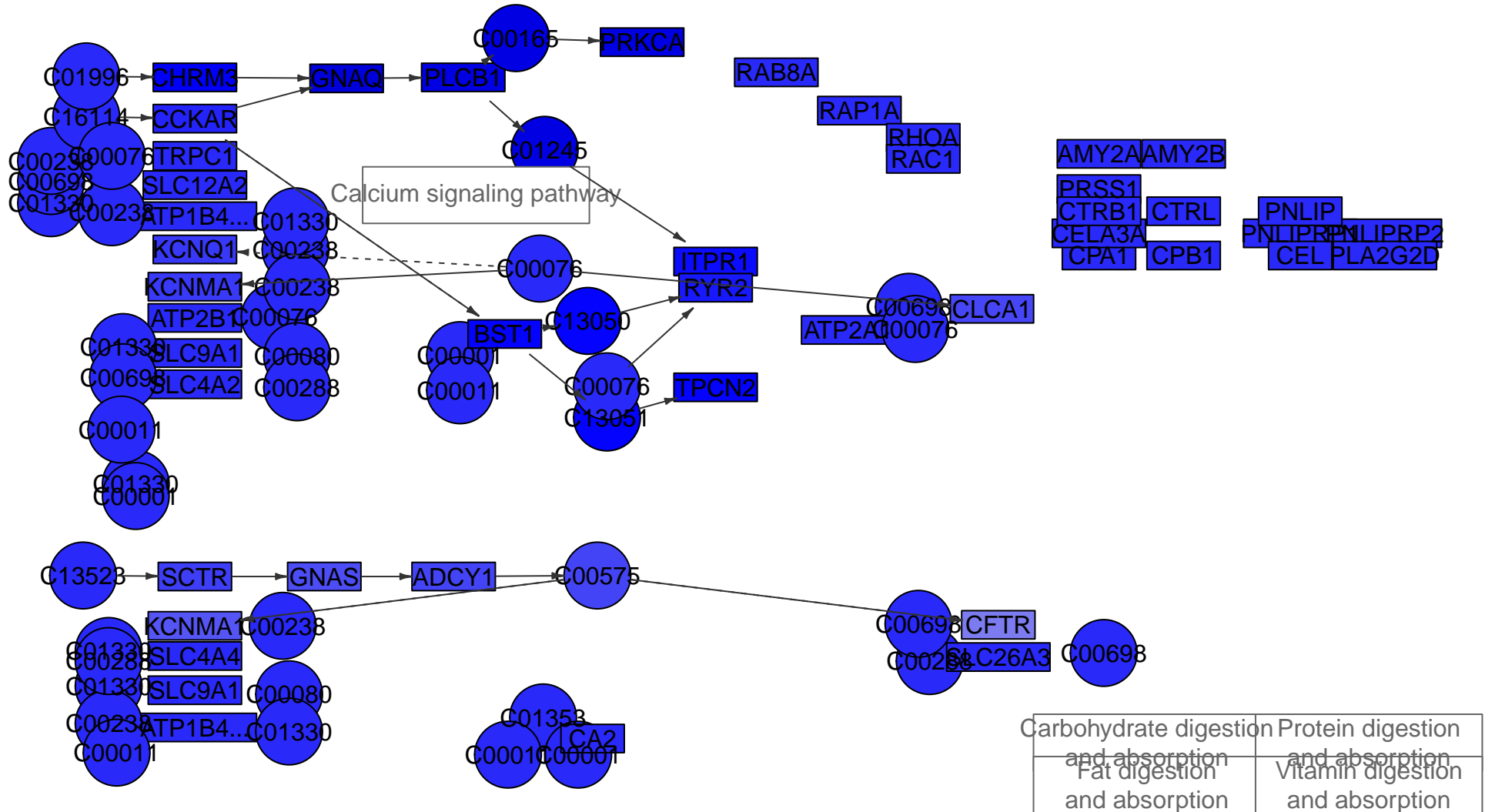

Pancreatic secretion
MPI-207

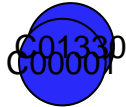

Tight junction

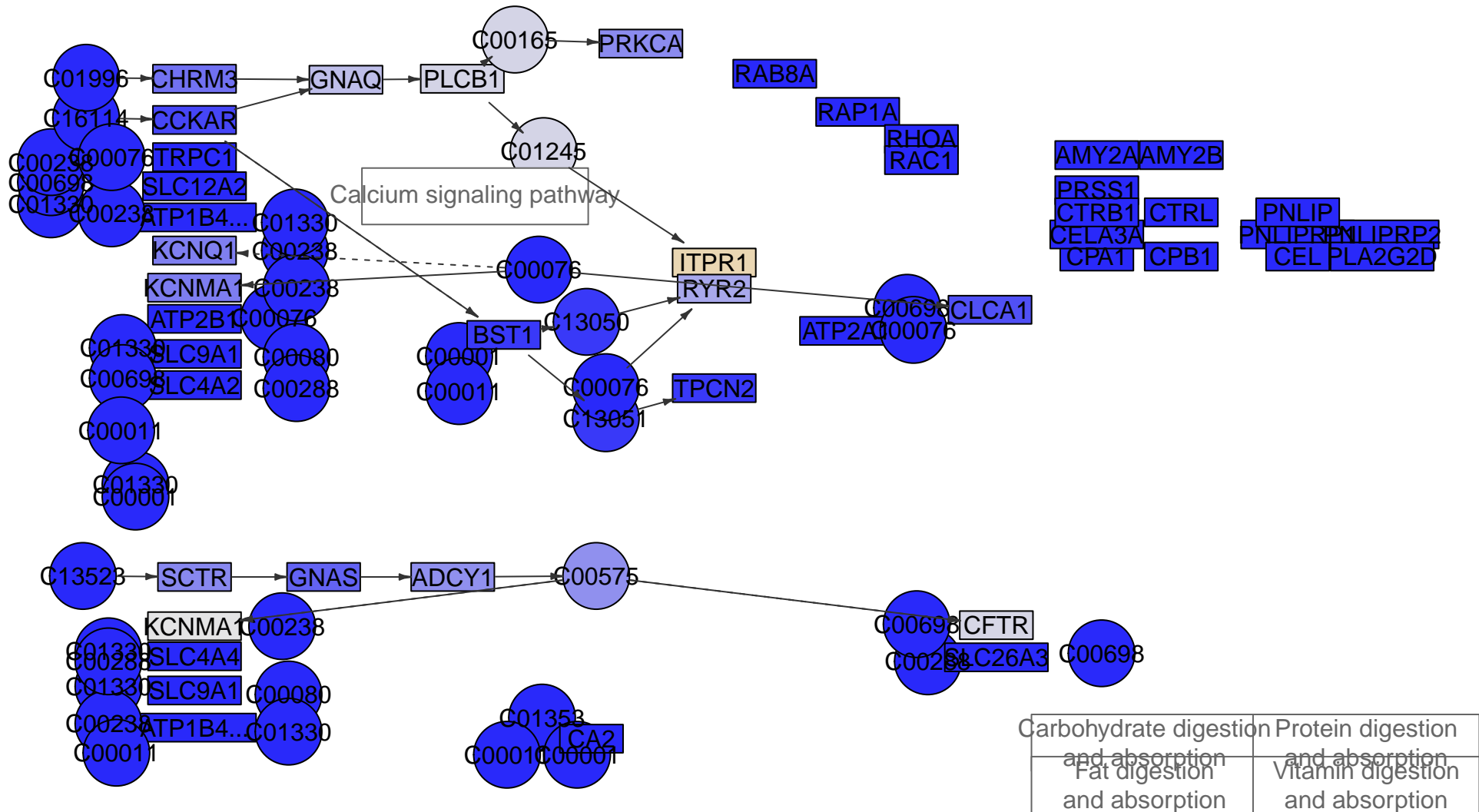

Pancreatic secretion
MPI-208



Tight junction

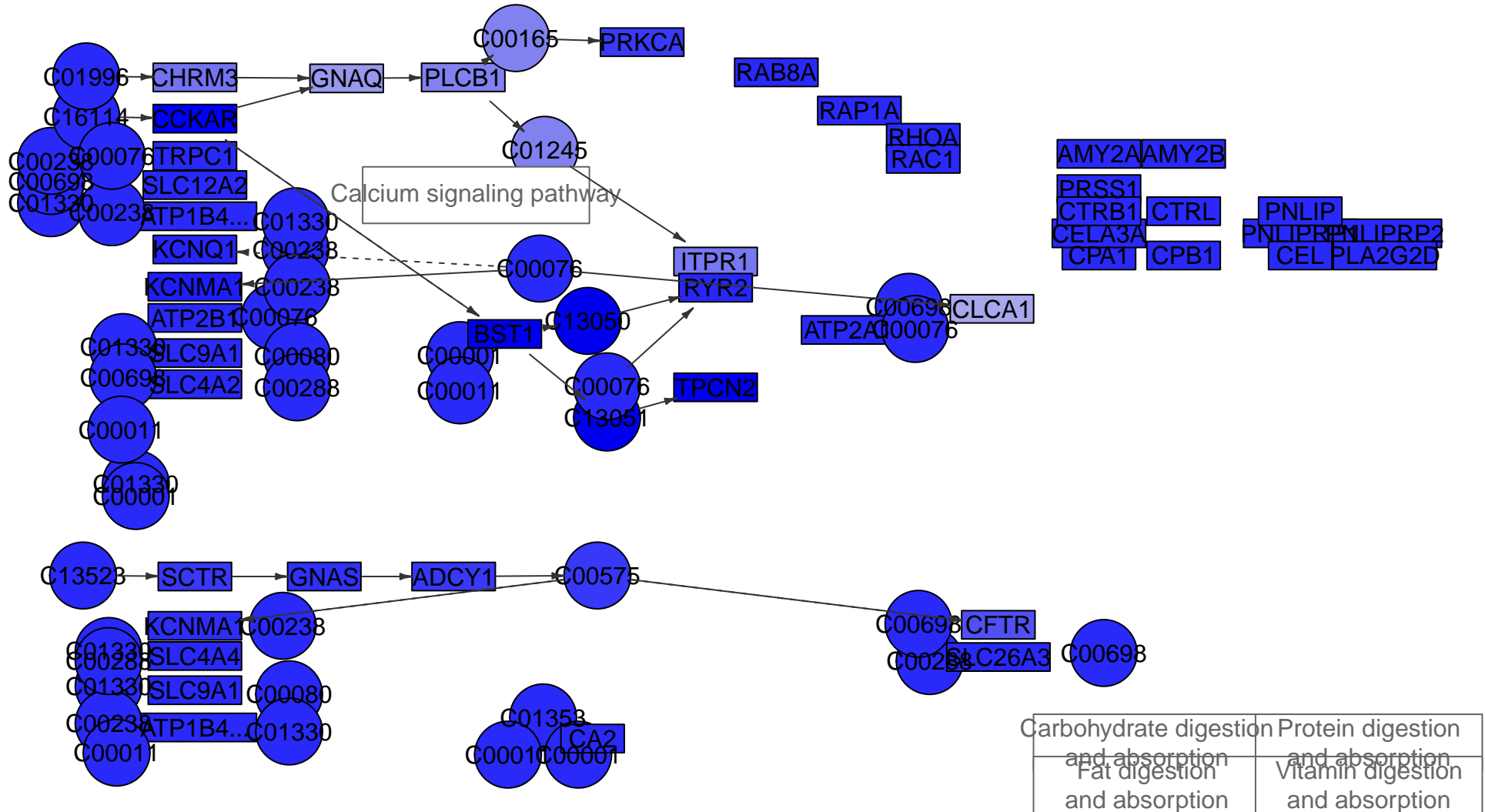

Pancreatic secretion
MPI-209

Tight junction

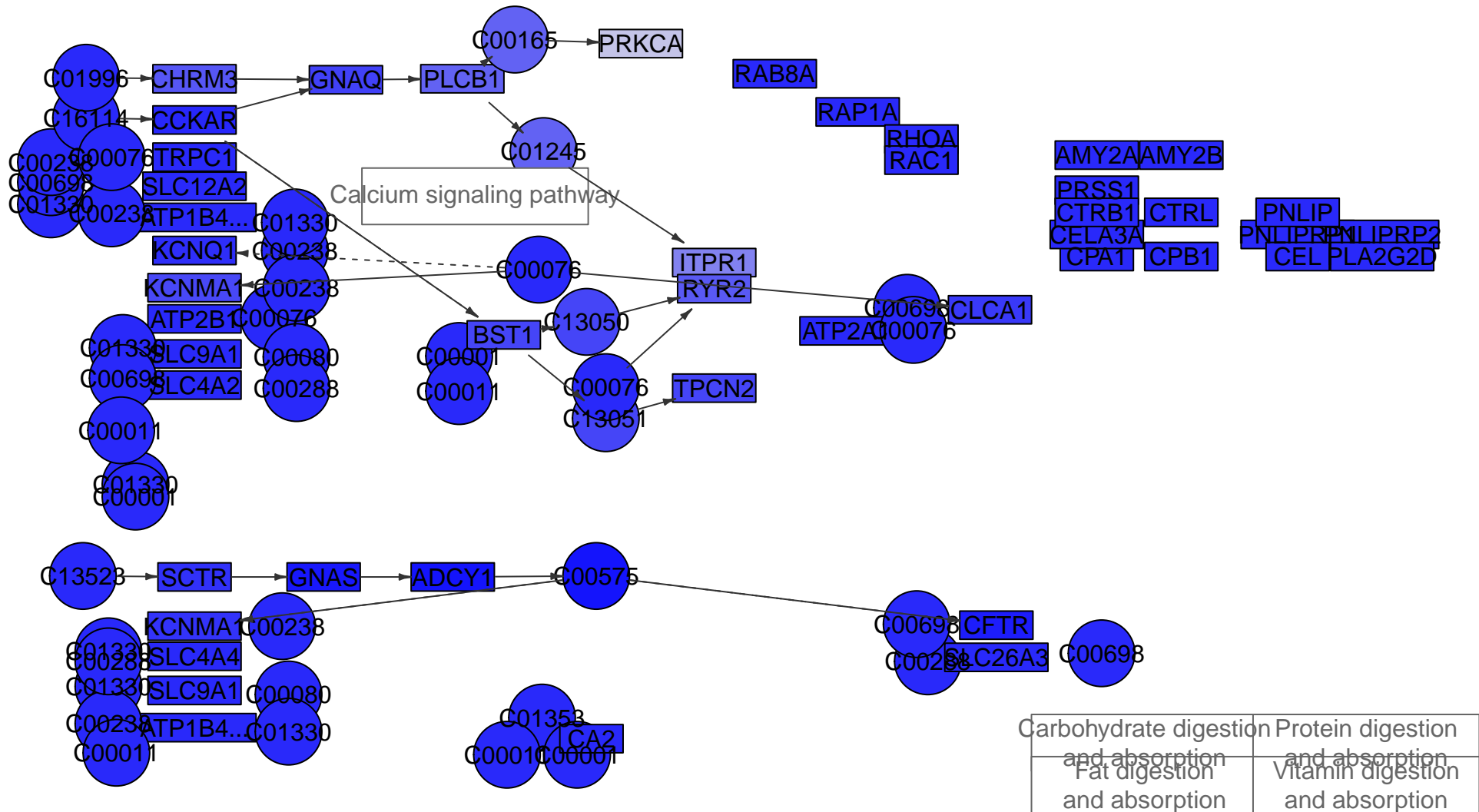

Pancreatic secretion
MPI-210



Tight junction

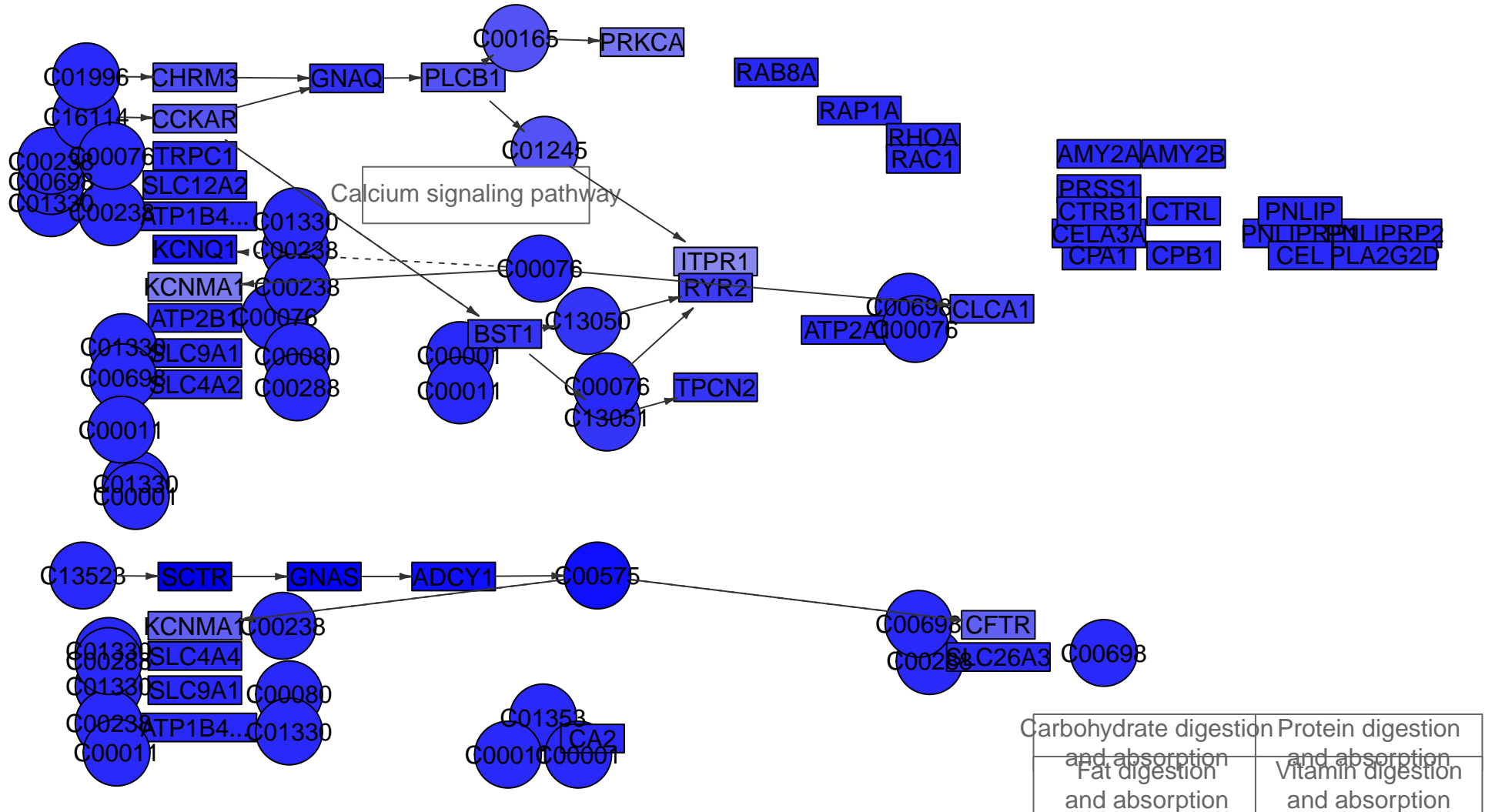

Carbohydrate digestion and absorption	Protein digestion and absorption
Fat digestion and absorption	Vitamin digestion and absorption

Pancreatic secretion
MPI-212

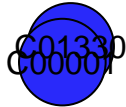

Tight junction

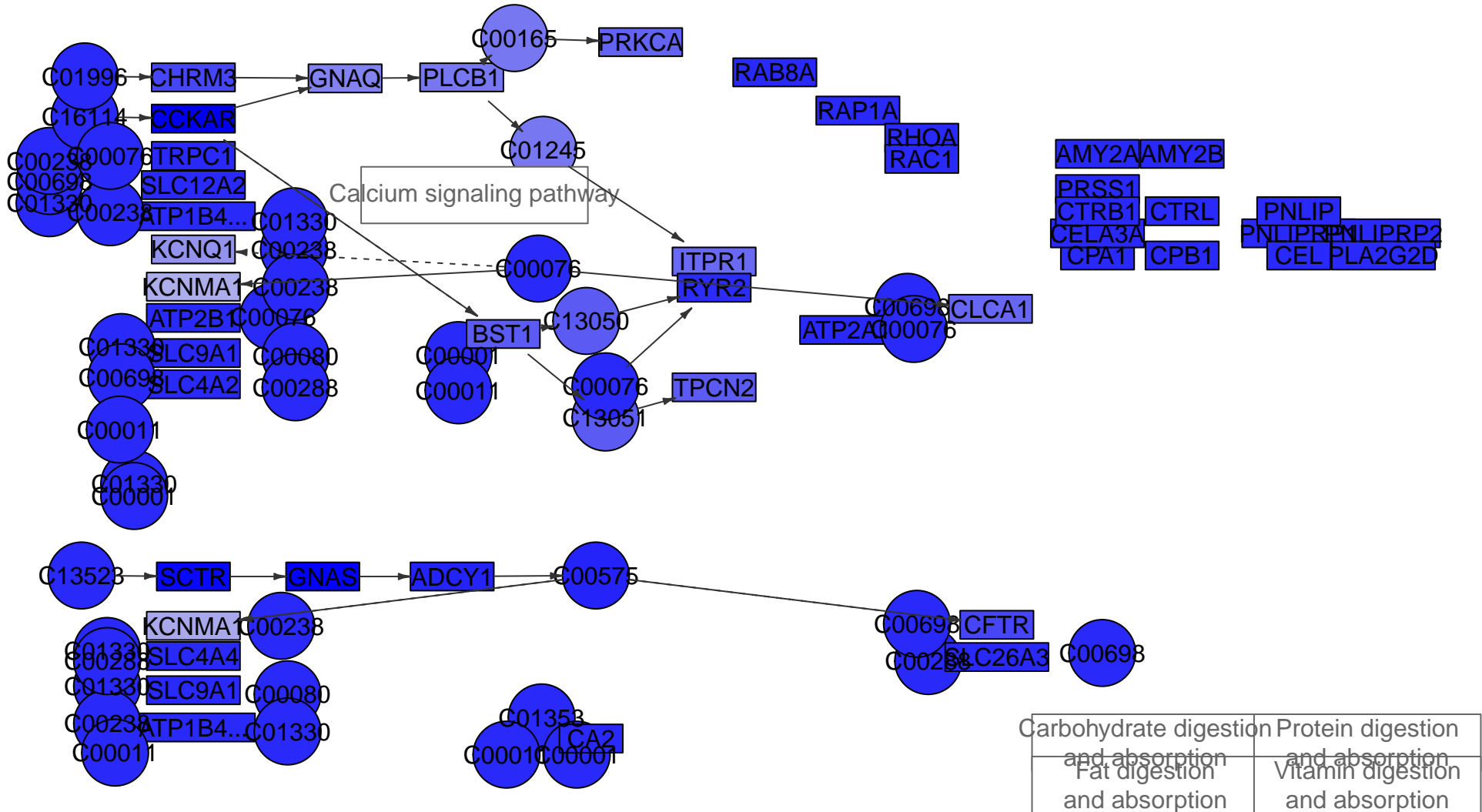

Pancreatic secretion
MPI-215

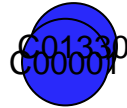

Tight junction

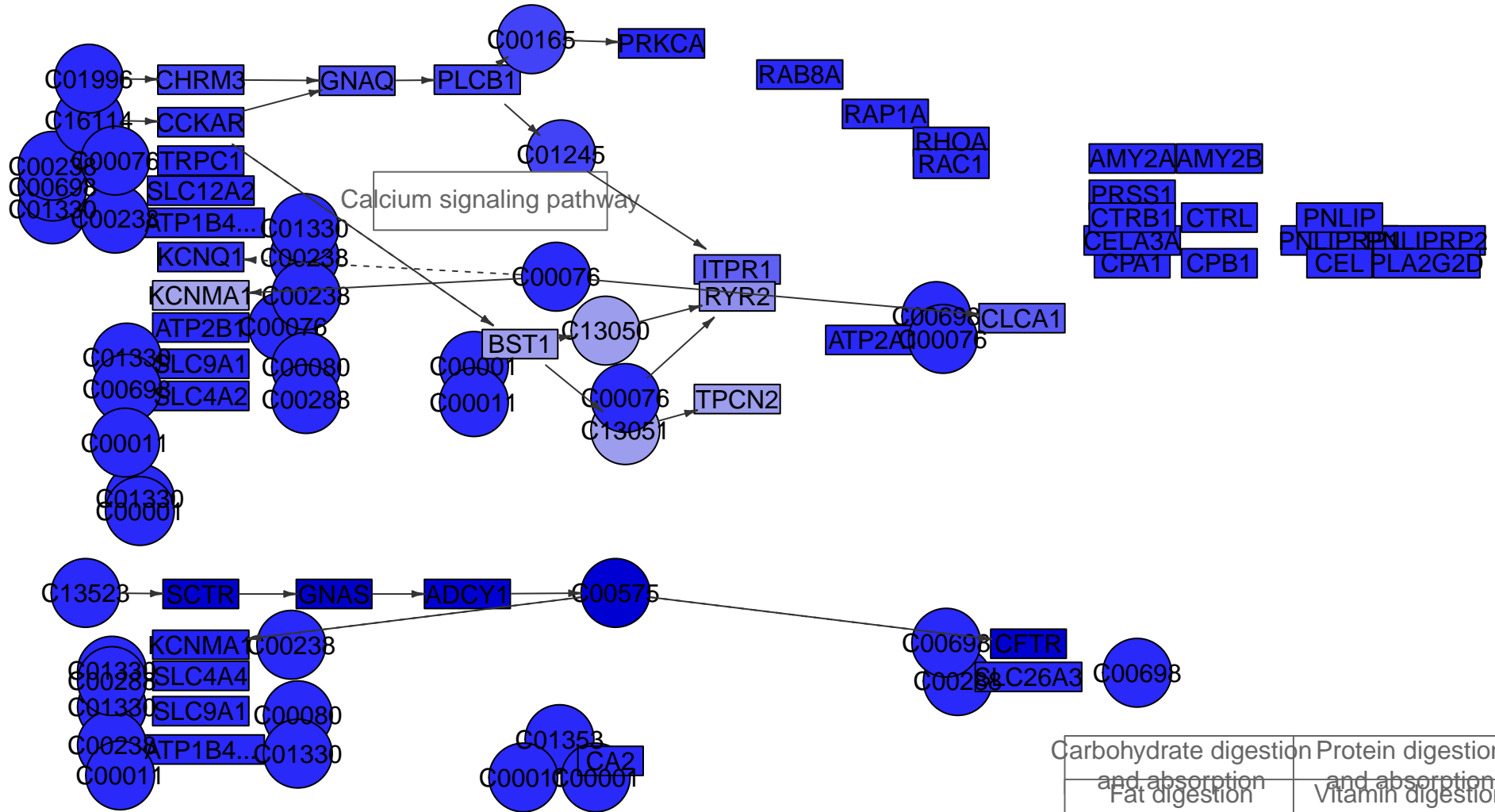

Carbohydrate digestion and absorption Fat digestion and absorption	Protein digestion and absorption Vitamin digestion and absorption
---	--

Pancreatic secretion
MPI-219

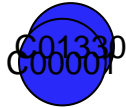

Tight junction

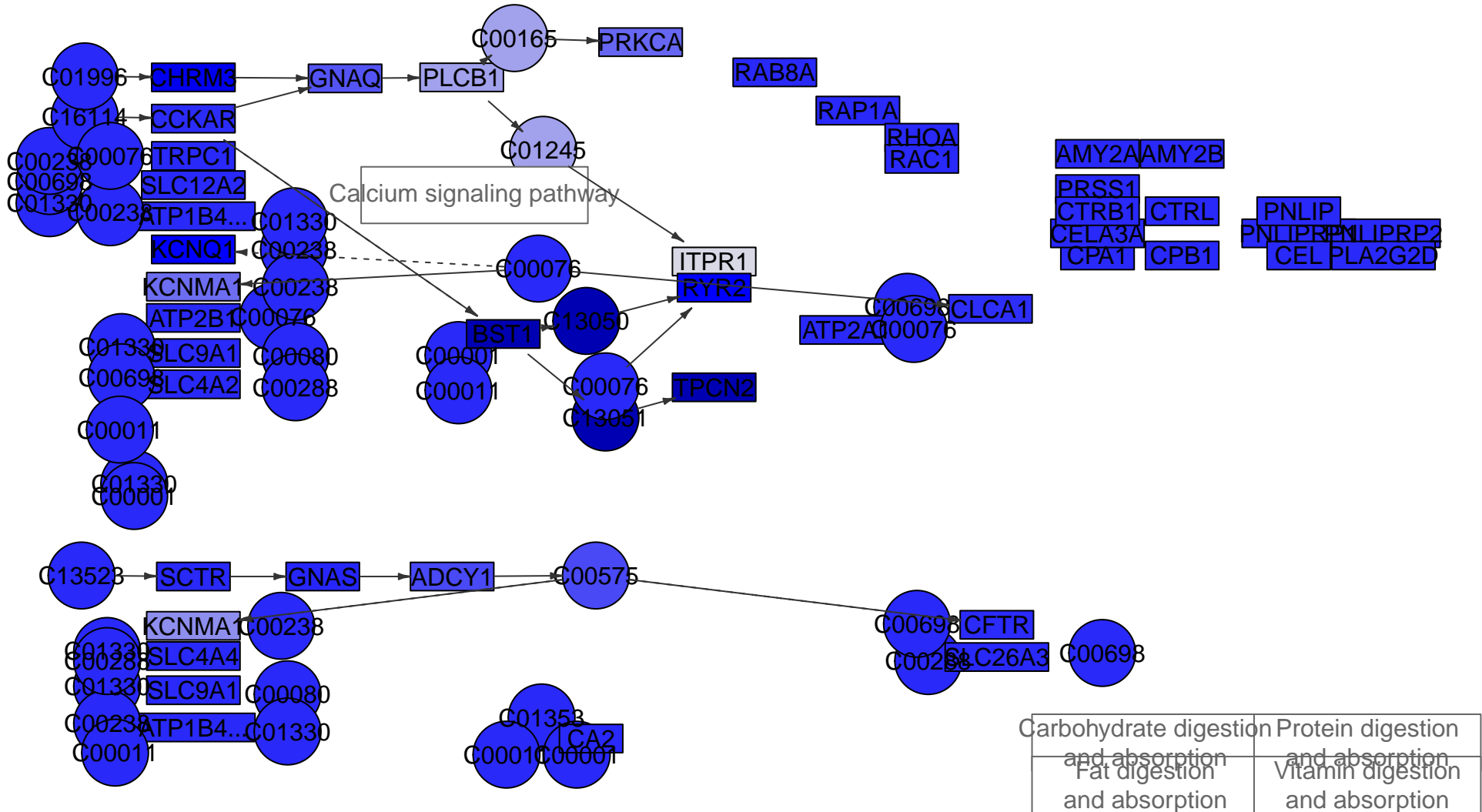

Carbohydrate digestion and absorption	Protein digestion and absorption
Fat digestion and absorption	Vitamin digestion and absorption

Pancreatic secretion
MPI-221

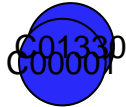

Tight junction

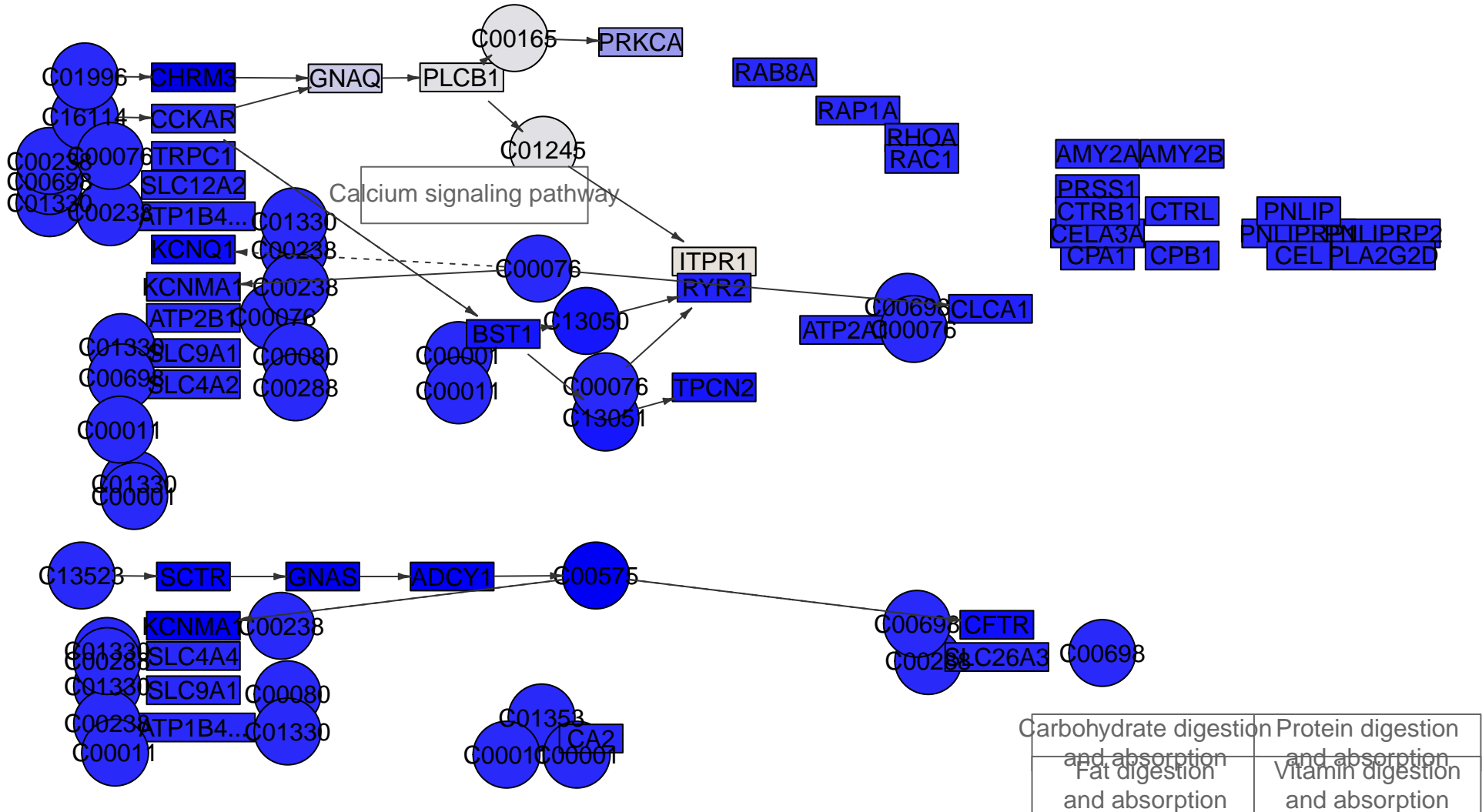

Pancreatic secretion
MPI-223a

Tight junction

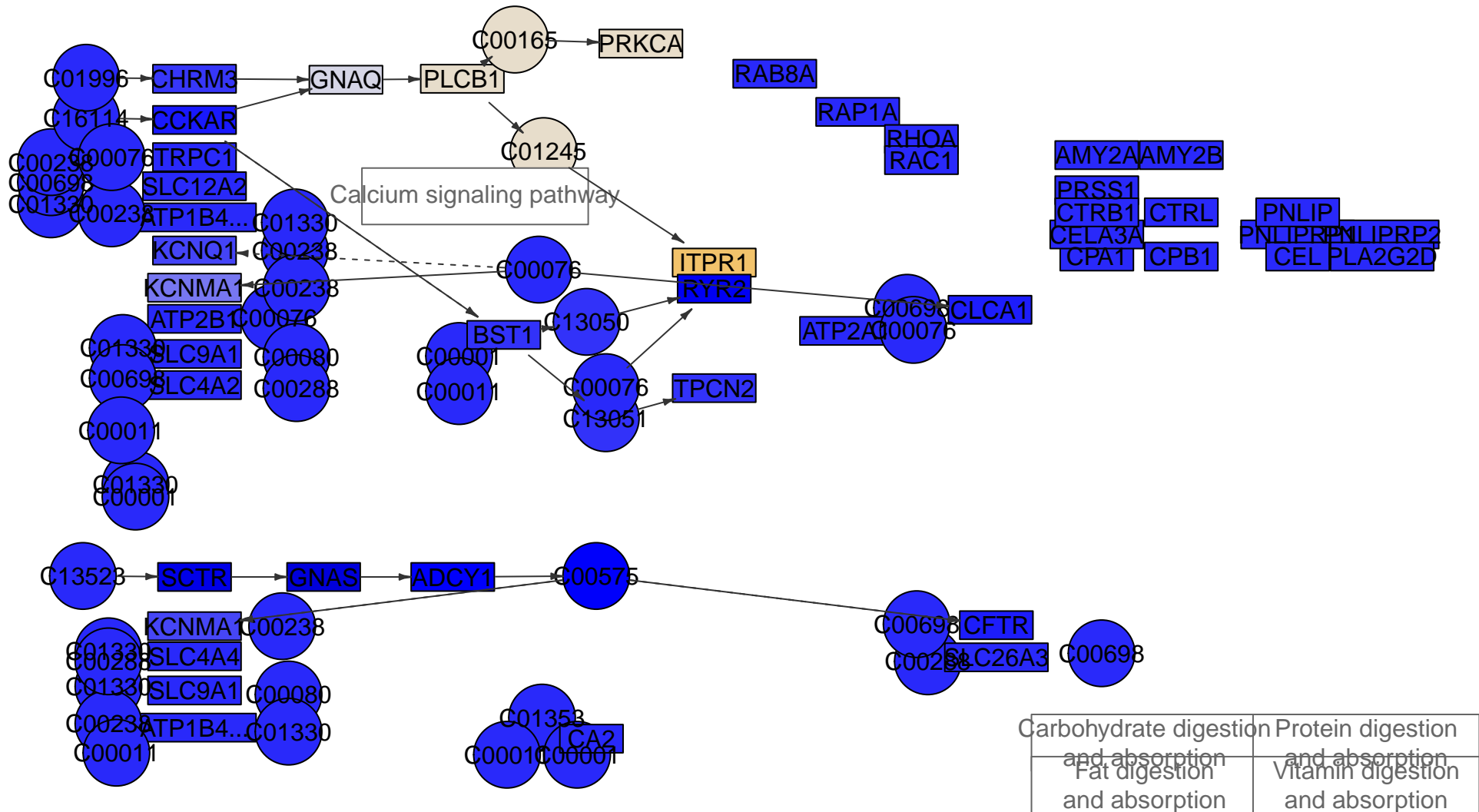

Pancreatic secretion
MPI-224



Tight junction

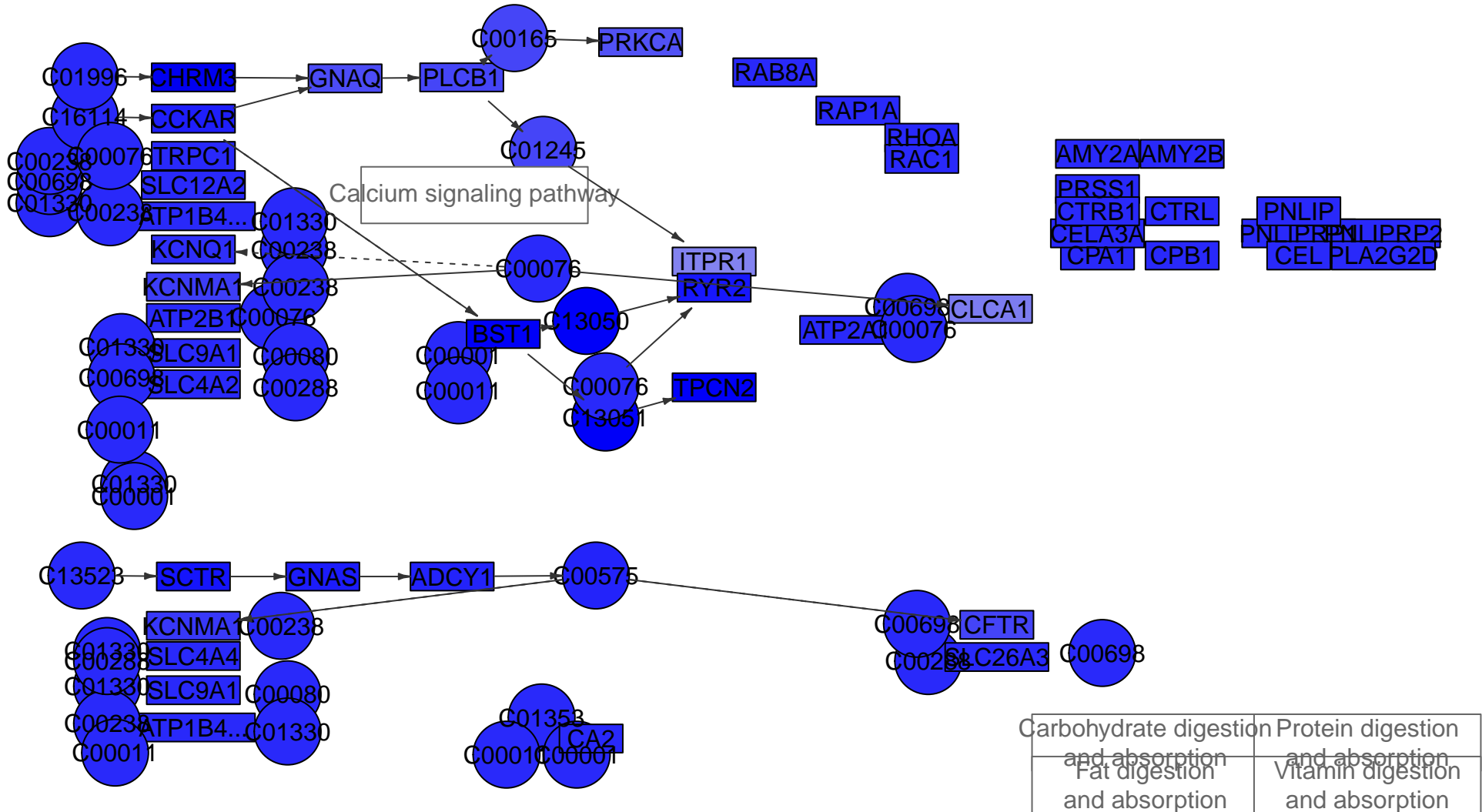

Pancreatic secretion
MPI-227



Tight junction

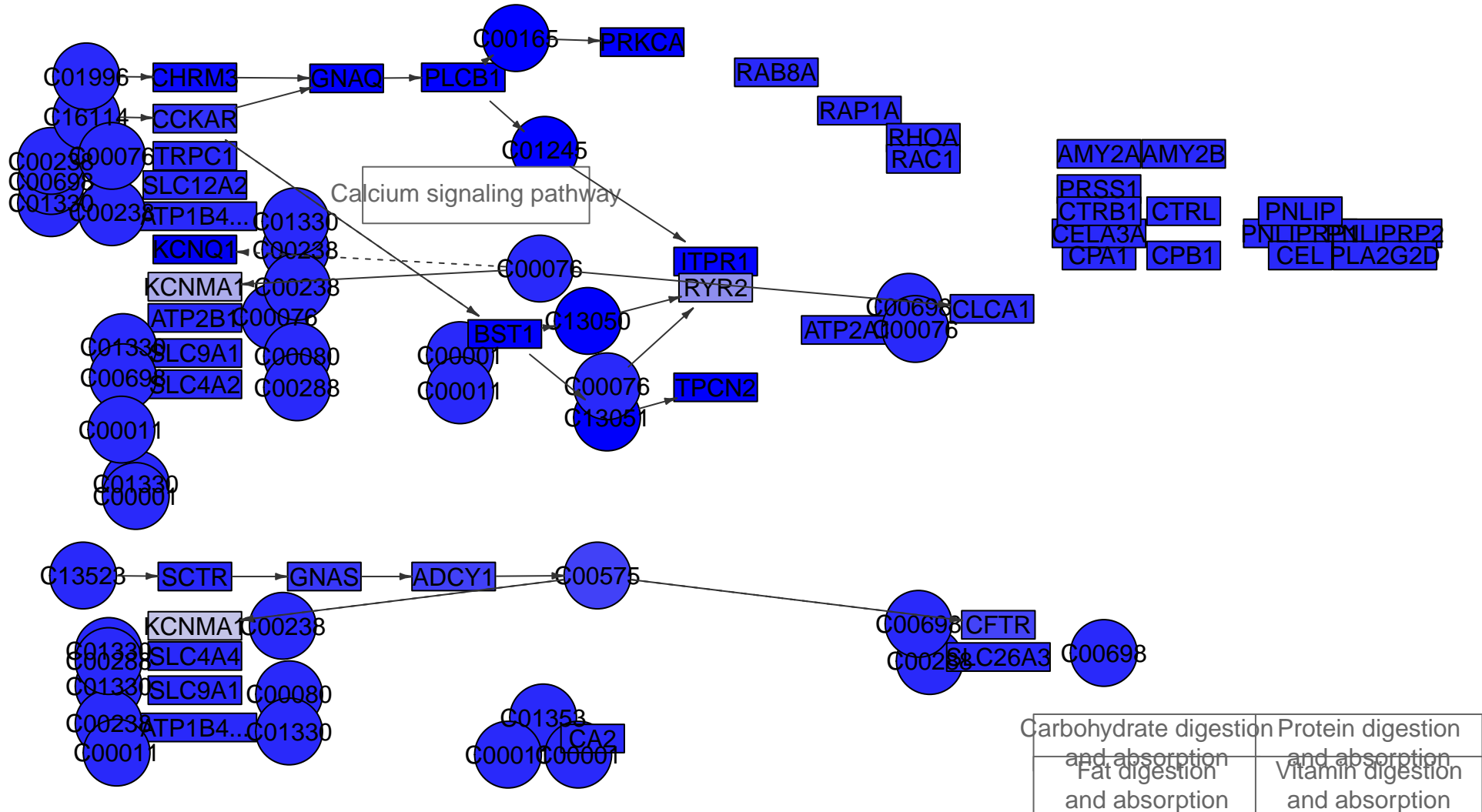

Pancreatic secretion
MPI-228



Tight junction

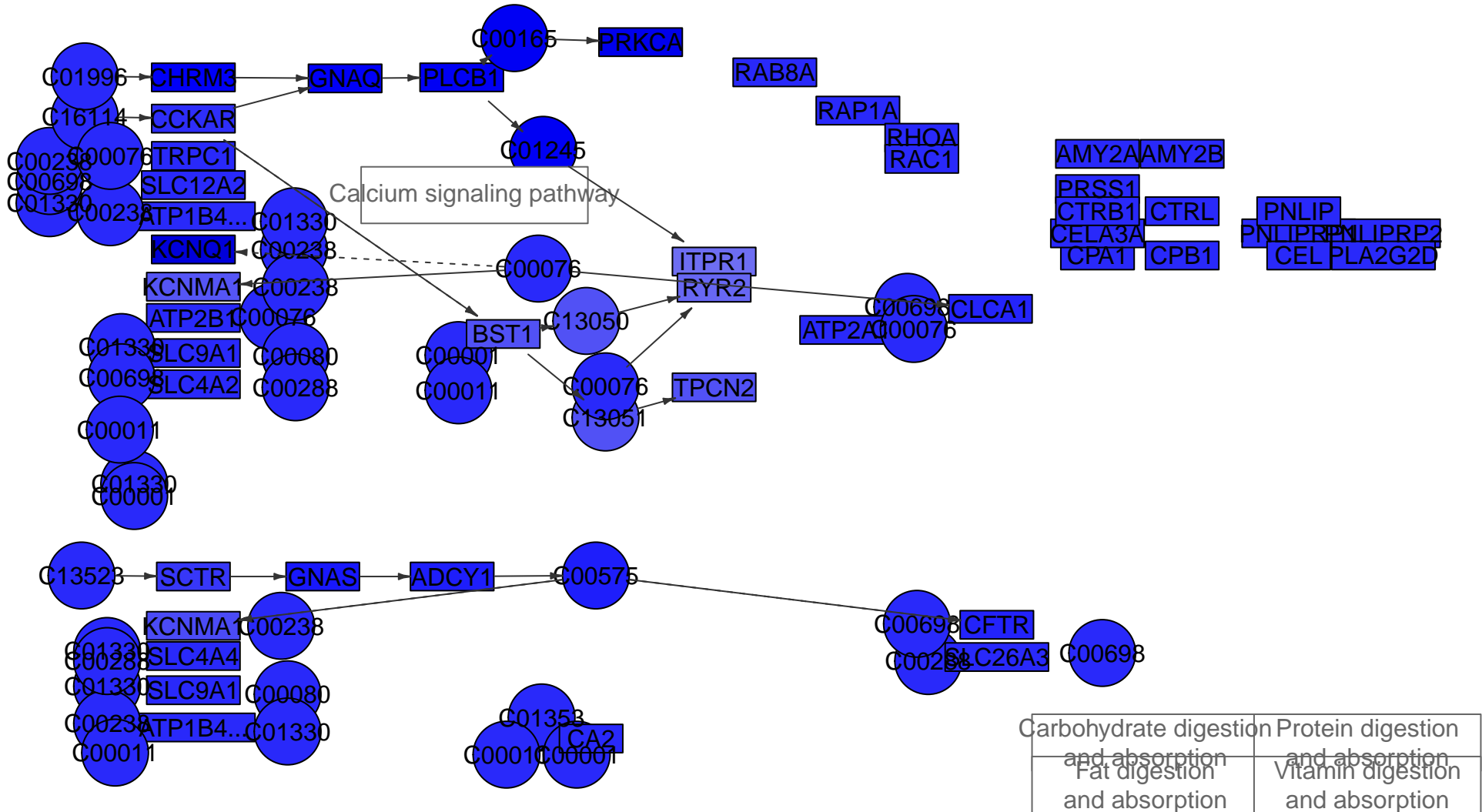

Carbohydrate digestion and absorption	Protein digestion and absorption
Fat digestion and absorption	Vitamin digestion and absorption

Pancreatic secretion
MPI-229



Tight junction

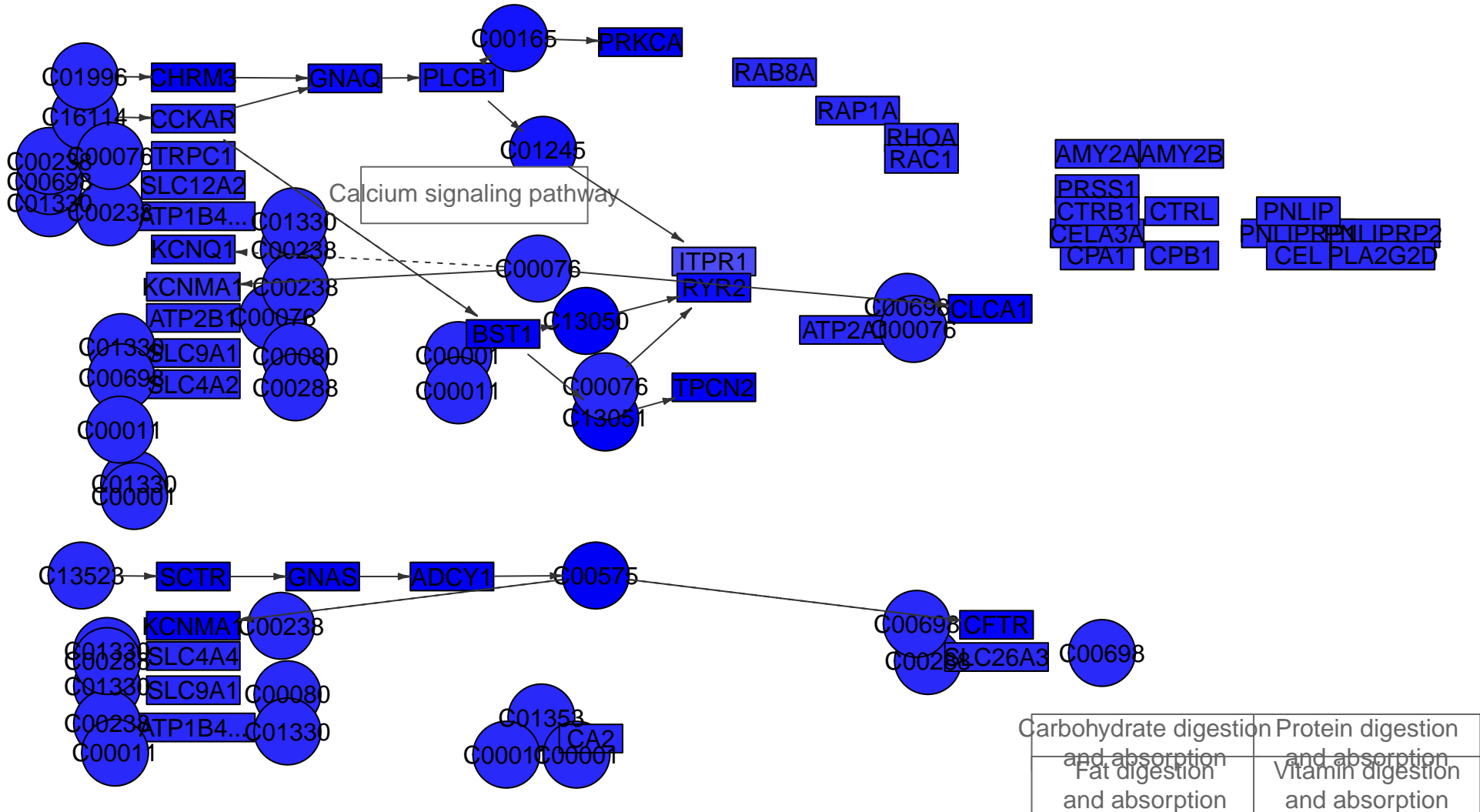

Pancreatic secretion
MPI-230

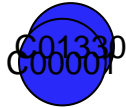

Tight junction

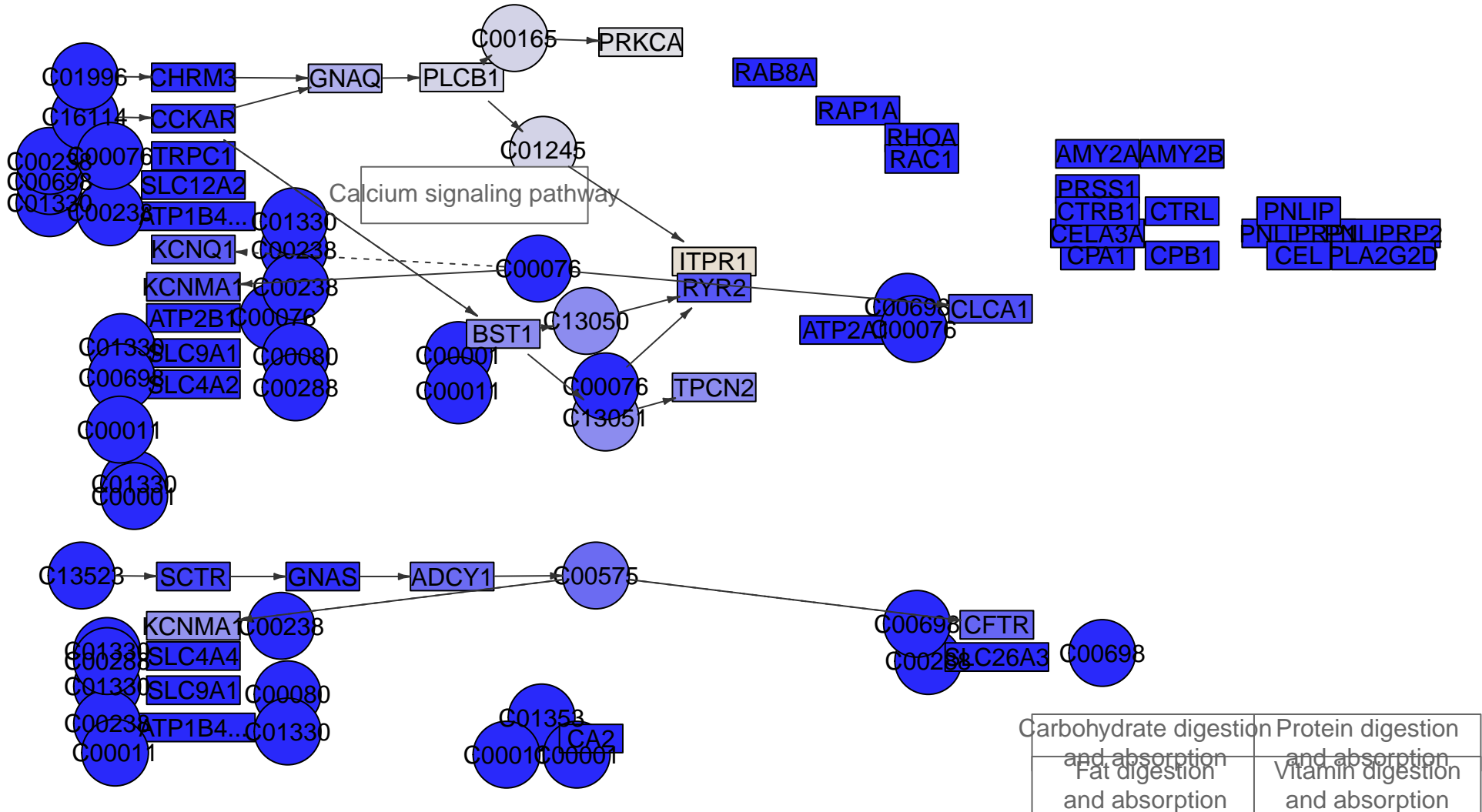

Pancreatic secretion
MPI-231



Tight junction

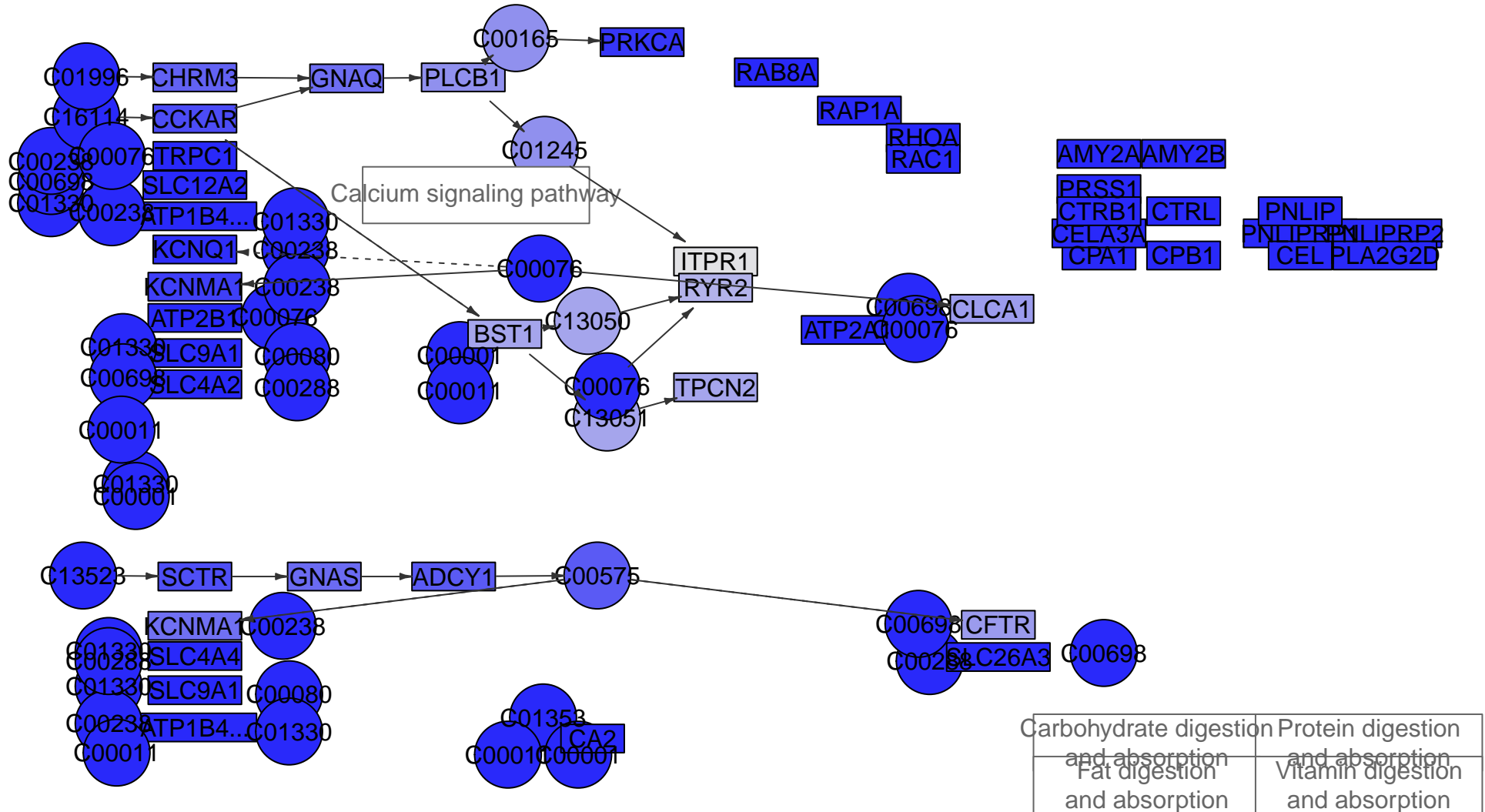

Pancreatic secretion
MPI-232

Tight junction

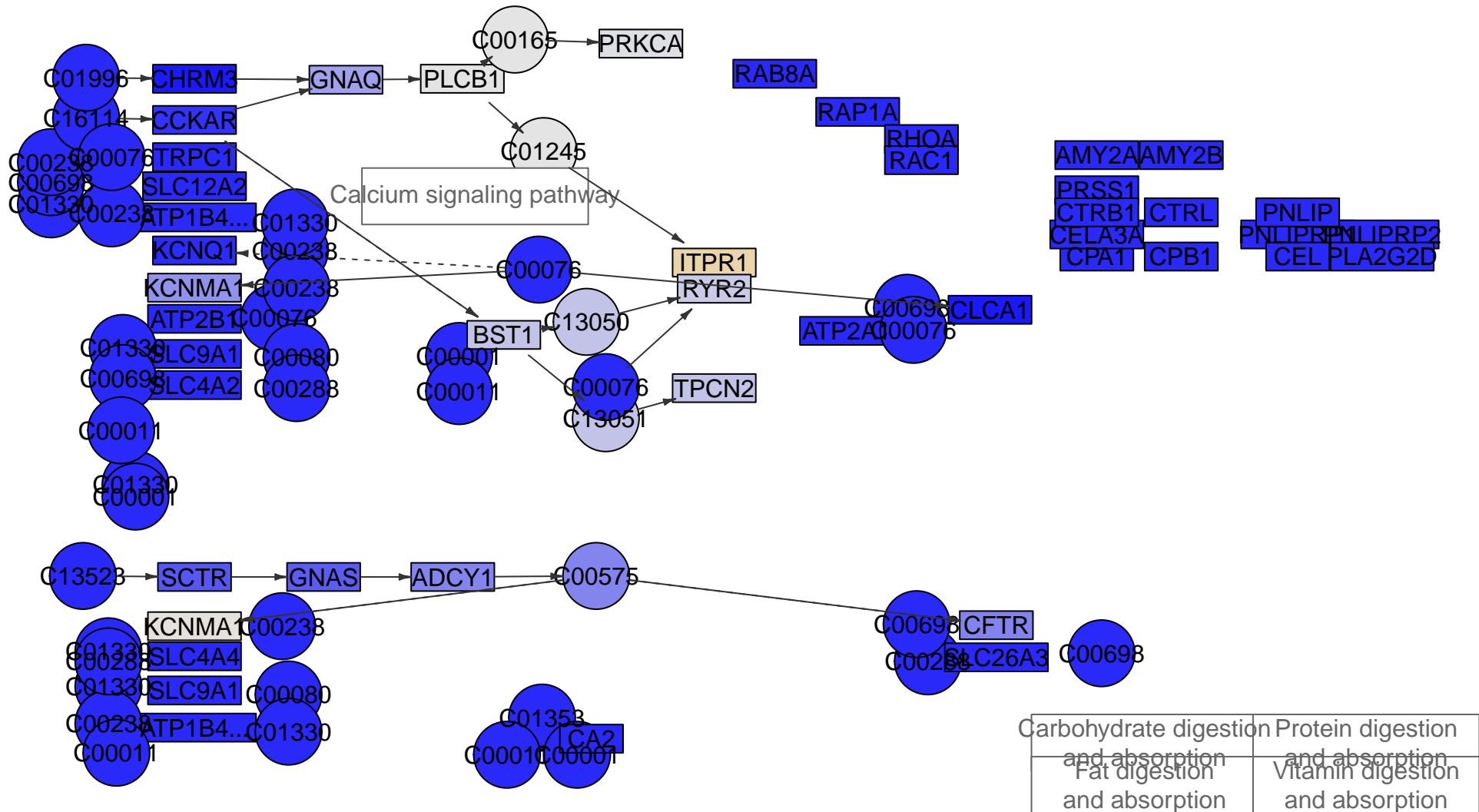

Pancreatic secretion
MPI-233



Tight junction

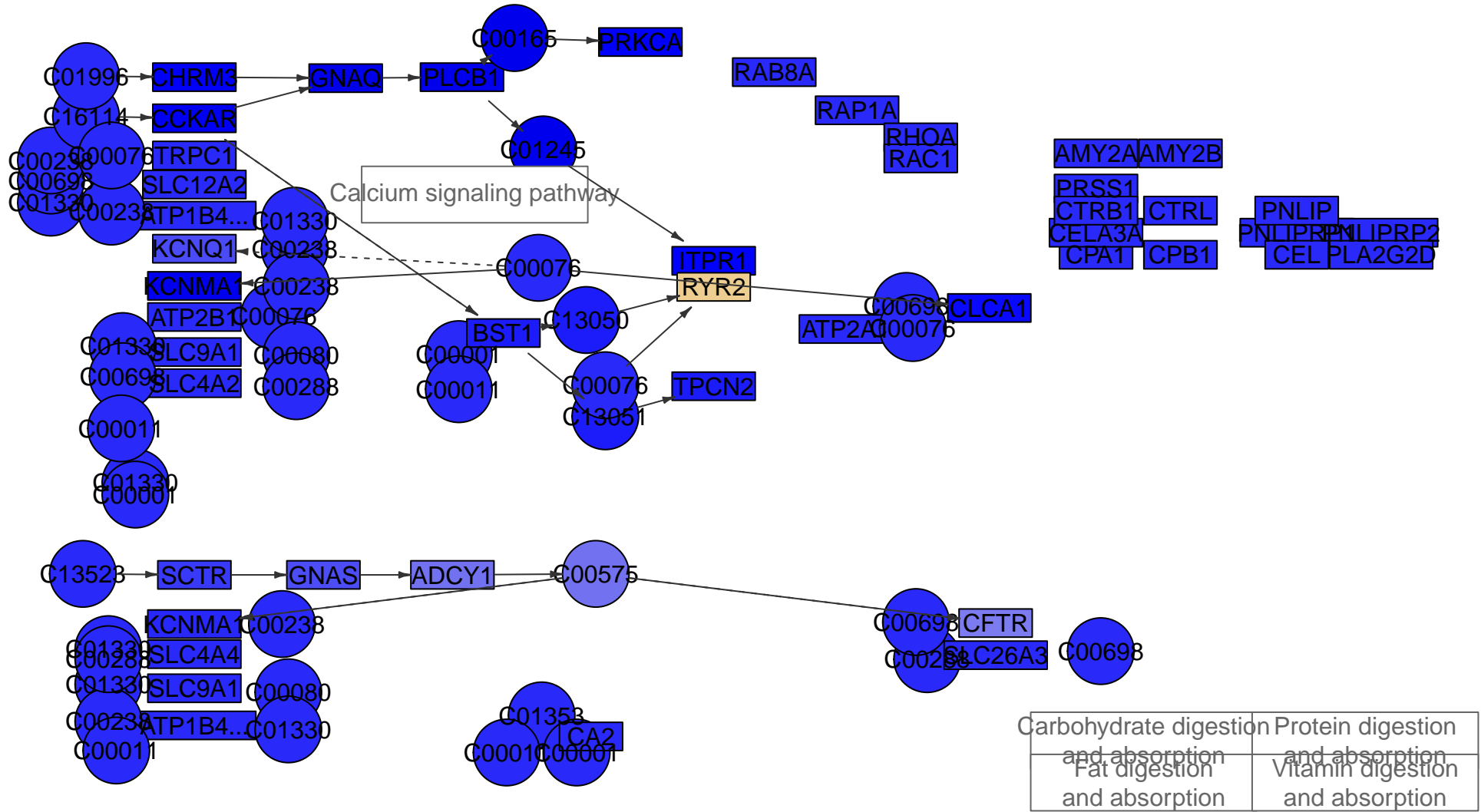

Carbohydrate digestion and absorption	Protein digestion and absorption
Fat digestion and absorption	Vitamin digestion and absorption

Pancreatic secretion
MPI-234

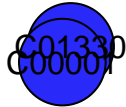

Tight junction

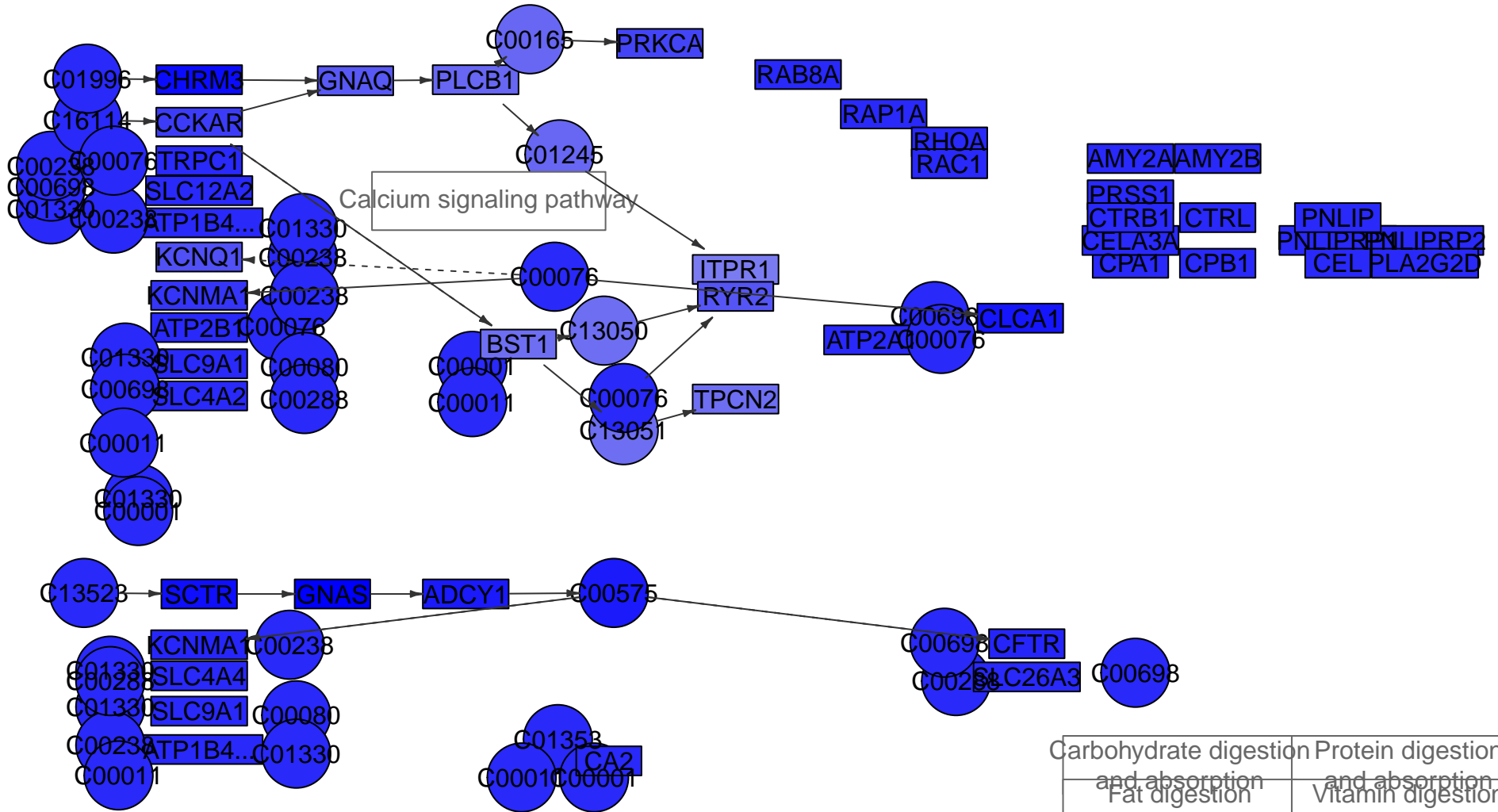

Carbohydrate digestion and absorption	Protein digestion and absorption
Fat digestion and absorption	Vitamin digestion and absorption

Pancreatic secretion
MPI-235



Tight junction

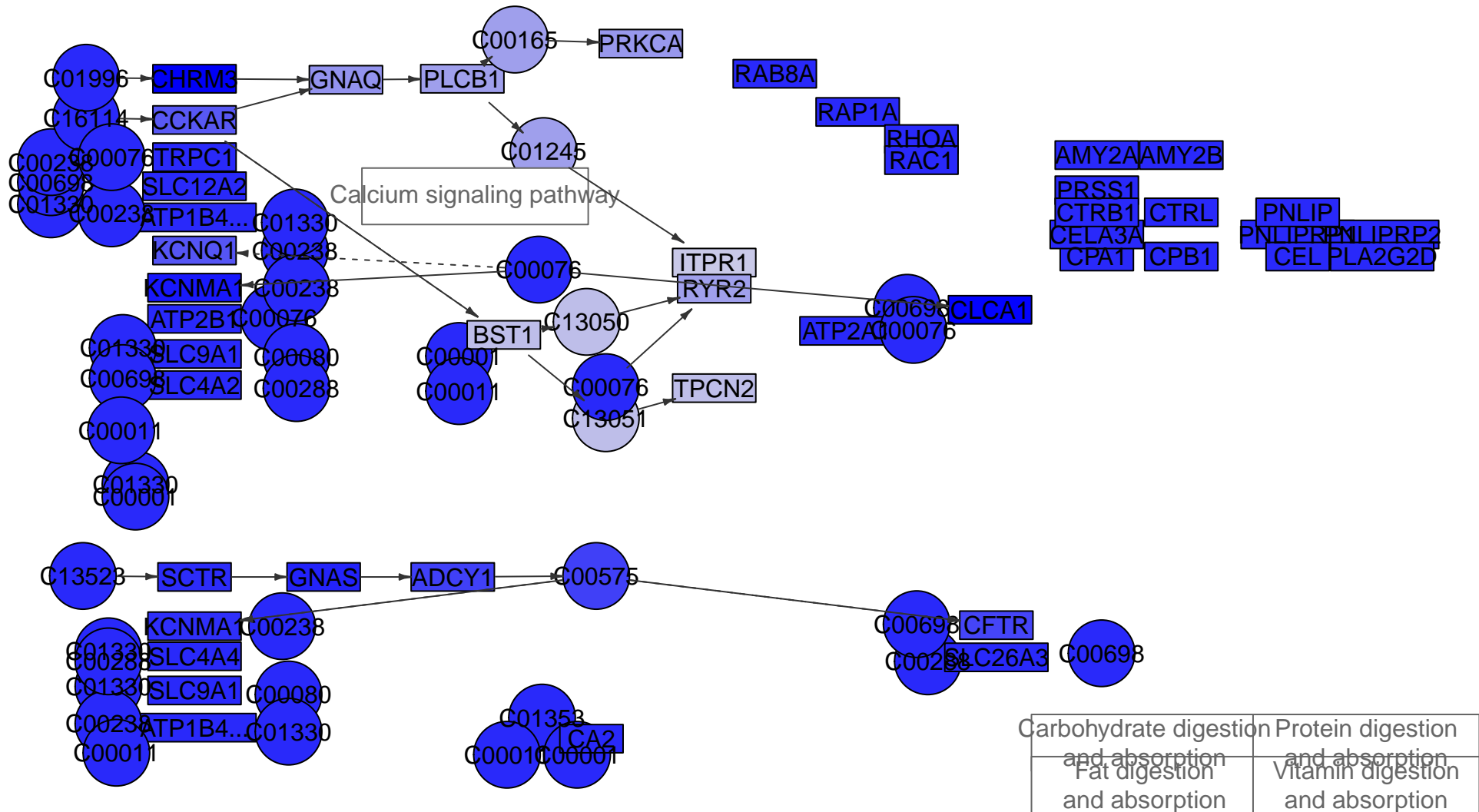

Pancreatic secretion
MPI-236

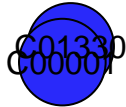

Tight junction

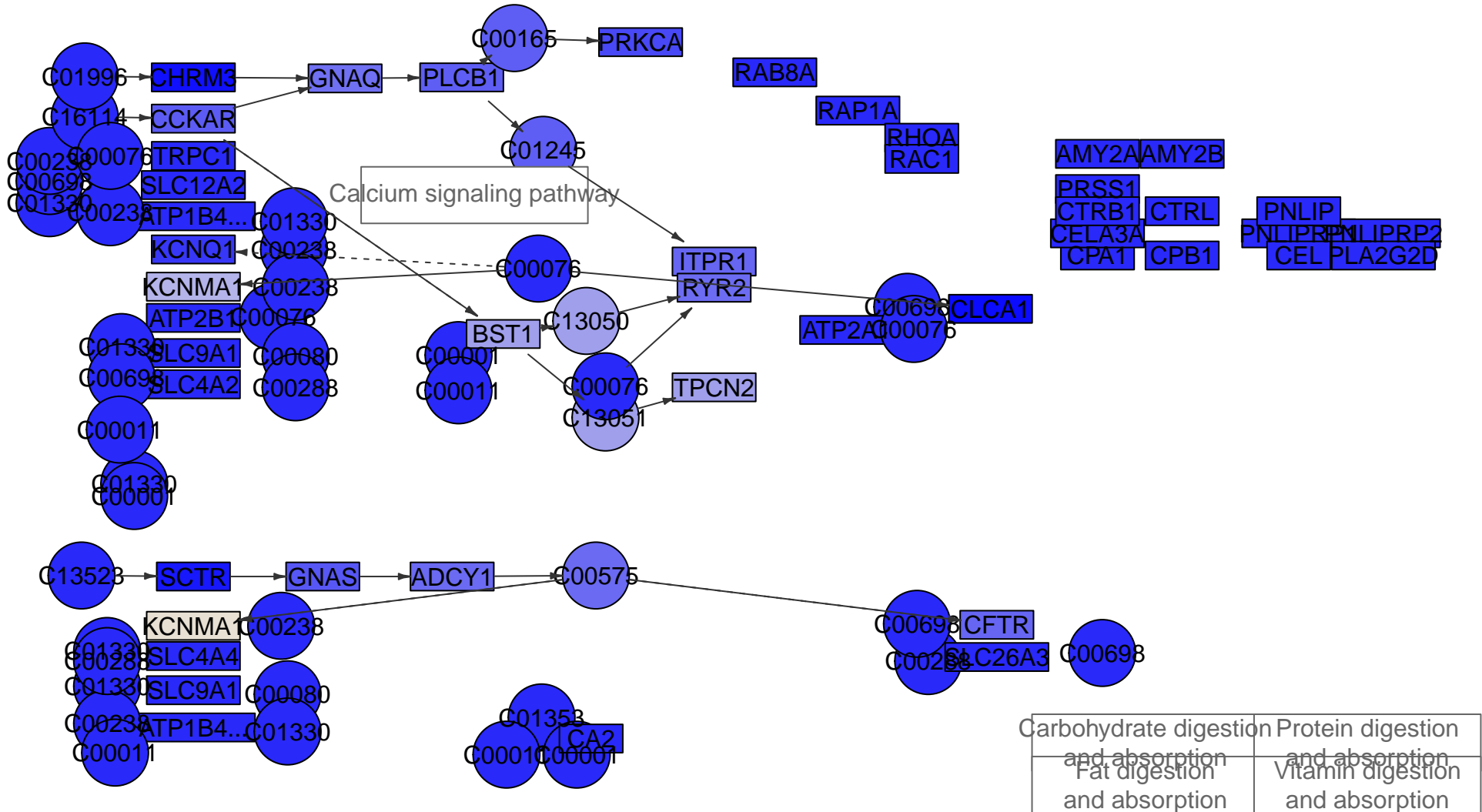

Pancreatic secretion
MPI-237



Tight junction

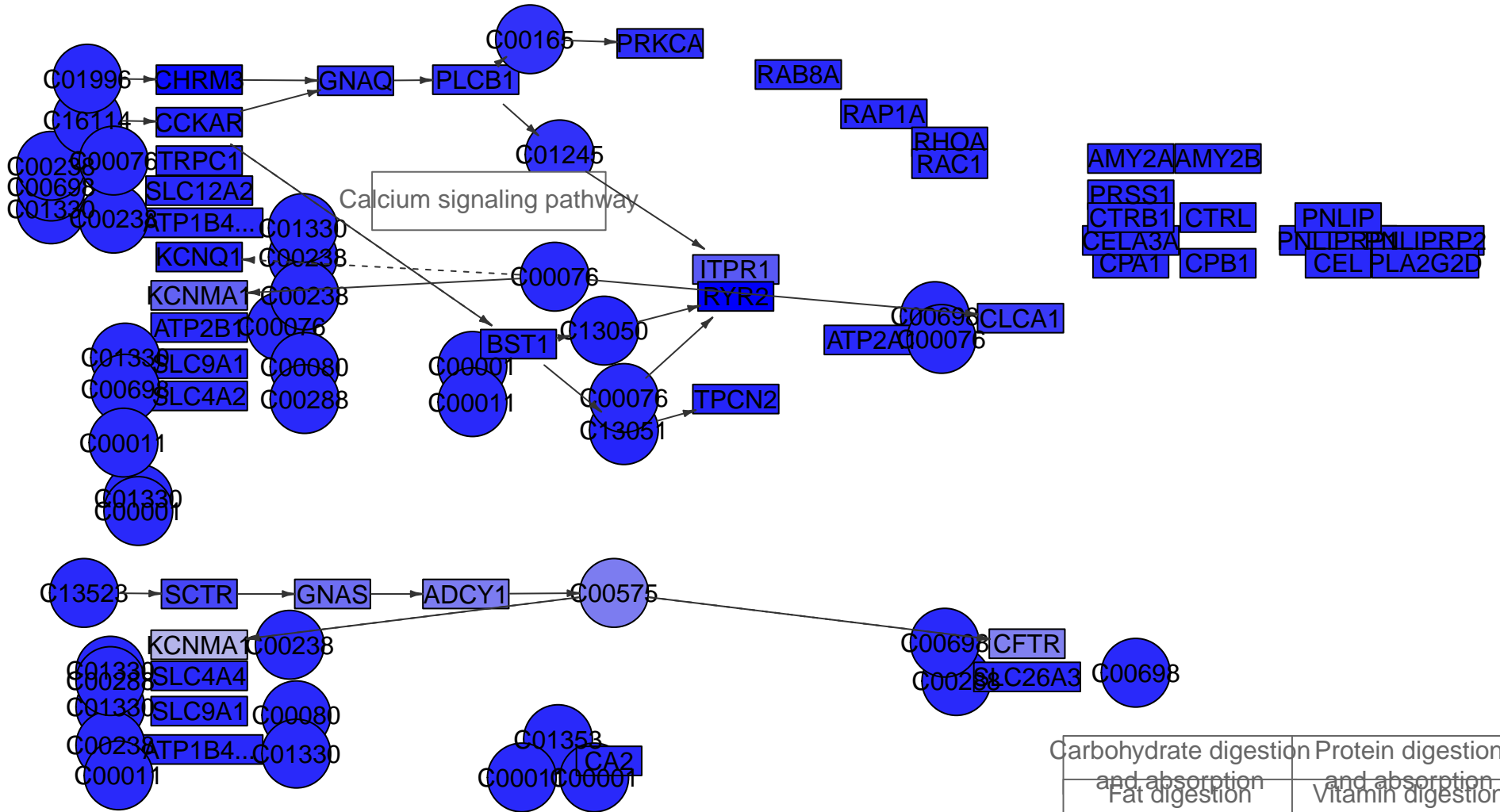

Carbohydrate digestion and absorption	Protein digestion and absorption
Fat digestion and absorption	Vitamin digestion and absorption

Pancreatic secretion
MPI-239



Tight junction

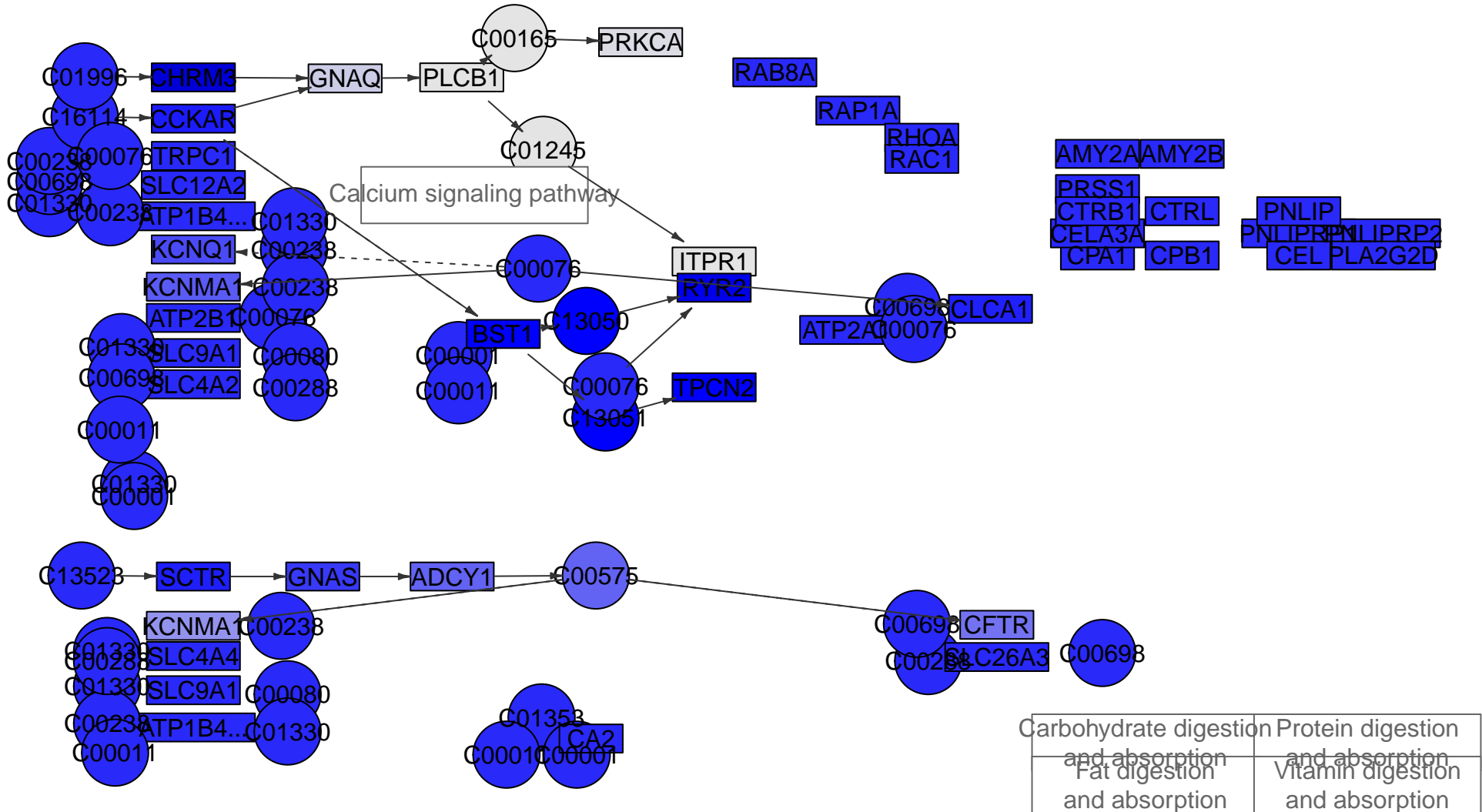

Pancreatic secretion
MPI-241



Tight junction

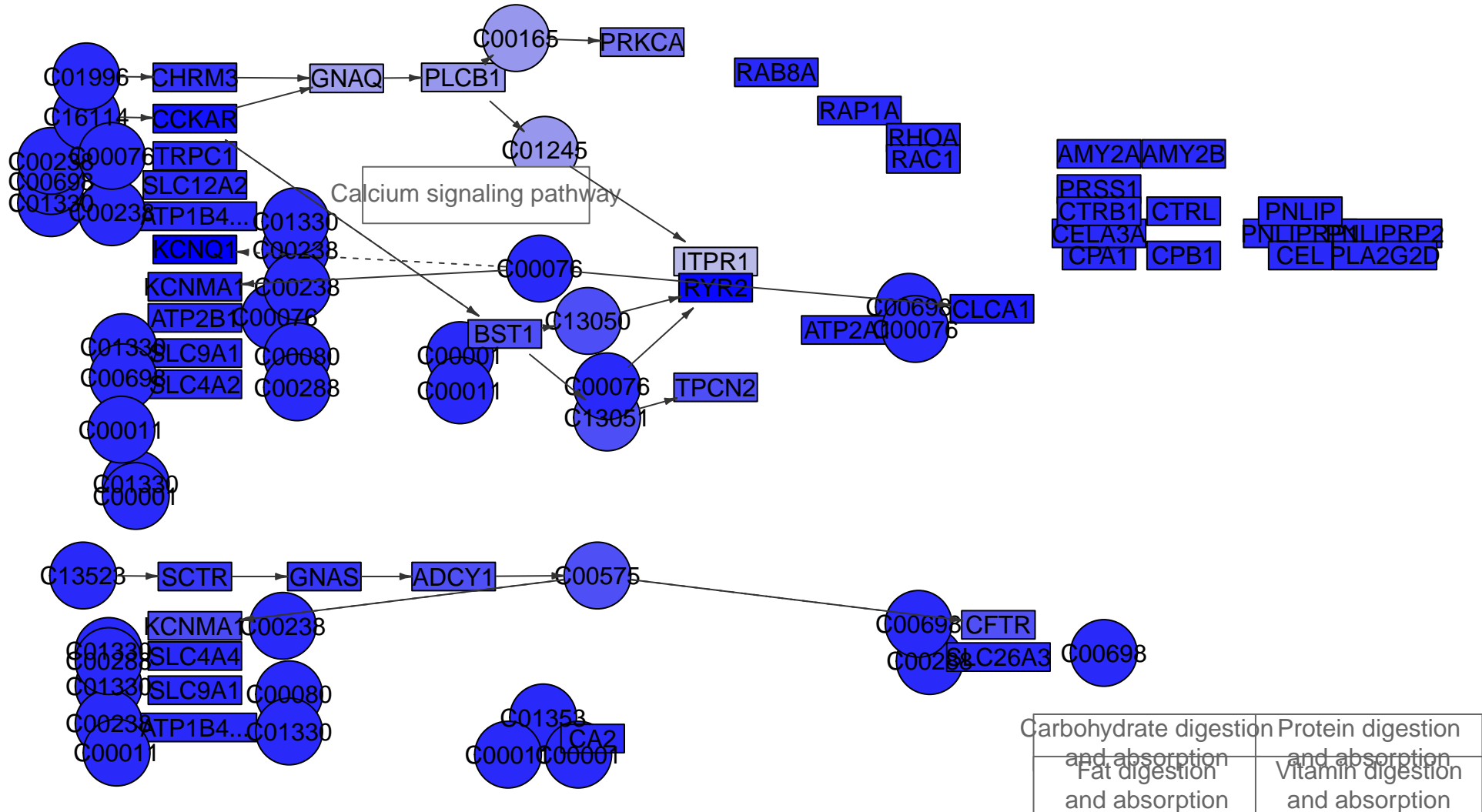

Pancreatic secretion
MPI-243



Tight junction

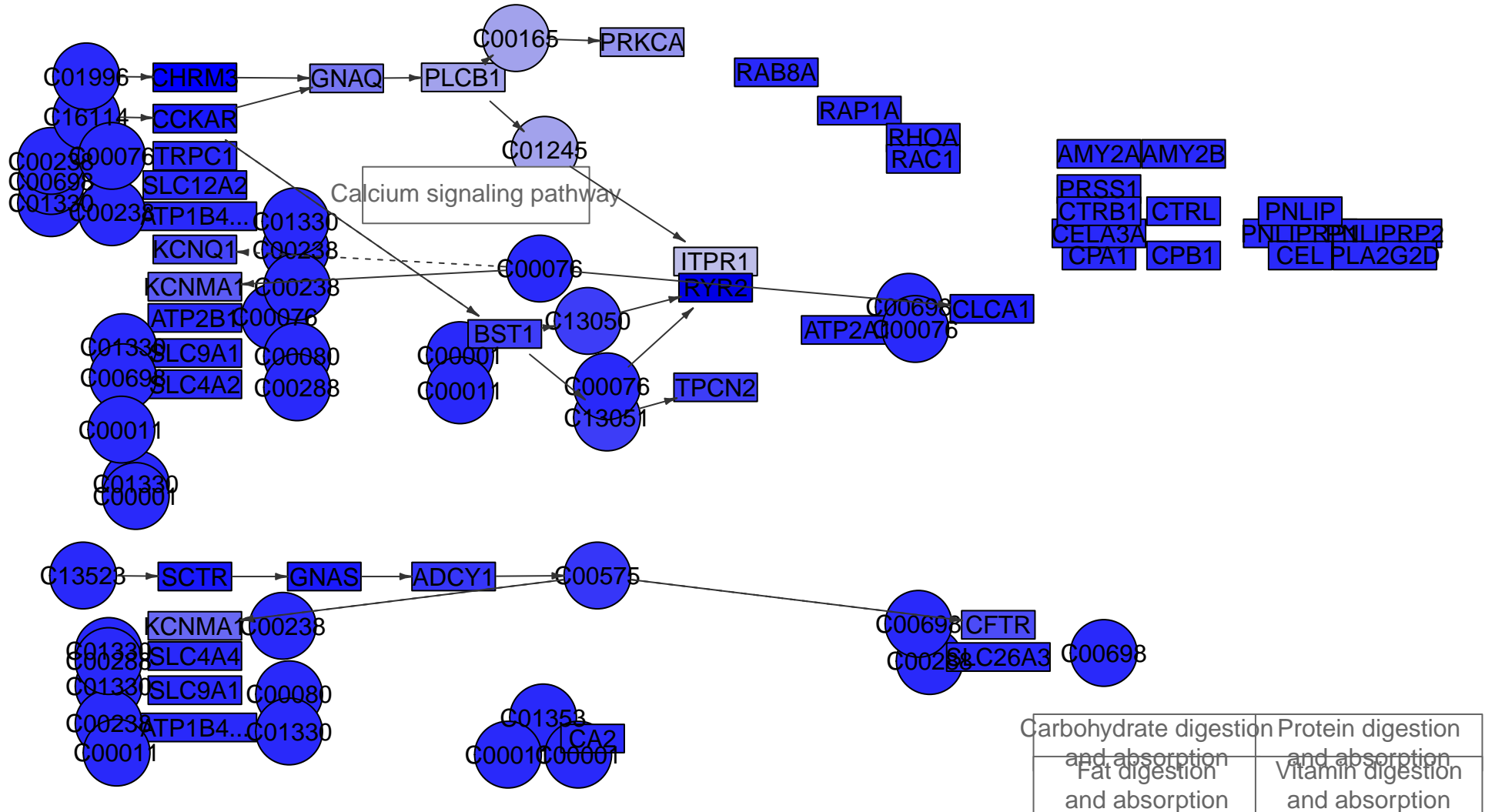

Pancreatic secretion
MPI-244

Tight junction

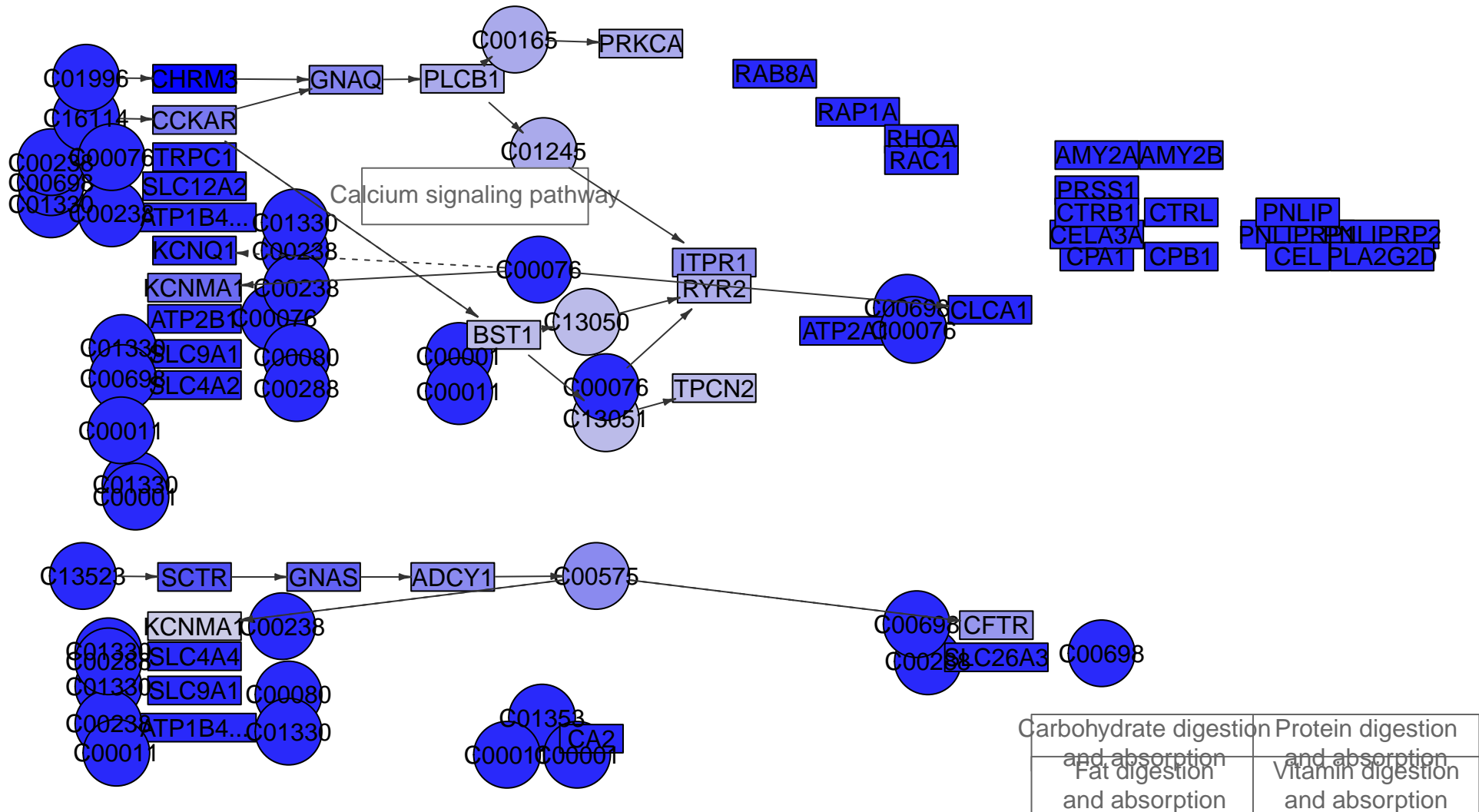

Pancreatic secretion
MPI-246

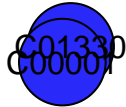

Tight junction

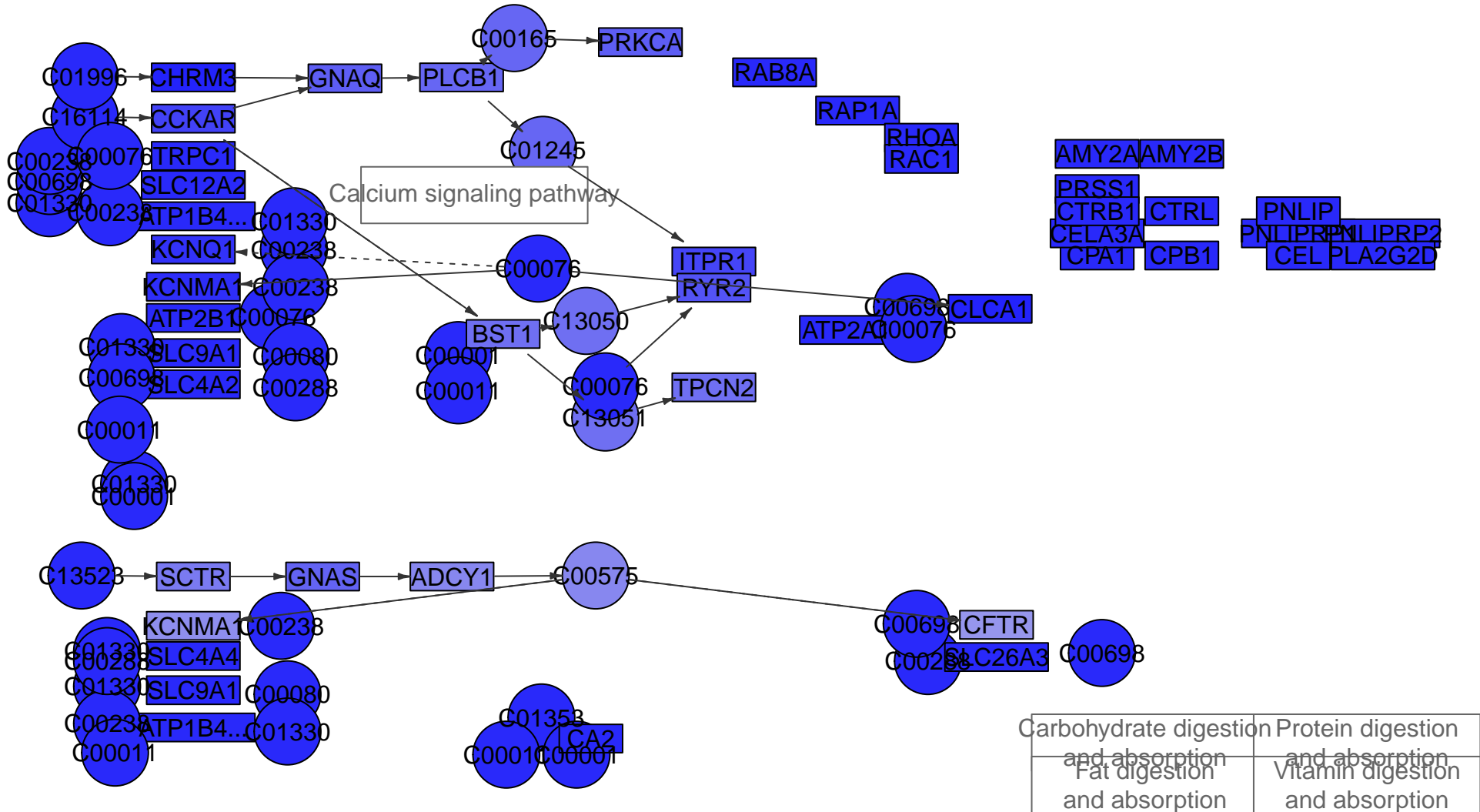

Pancreatic secretion
MPI-247



Tight junction

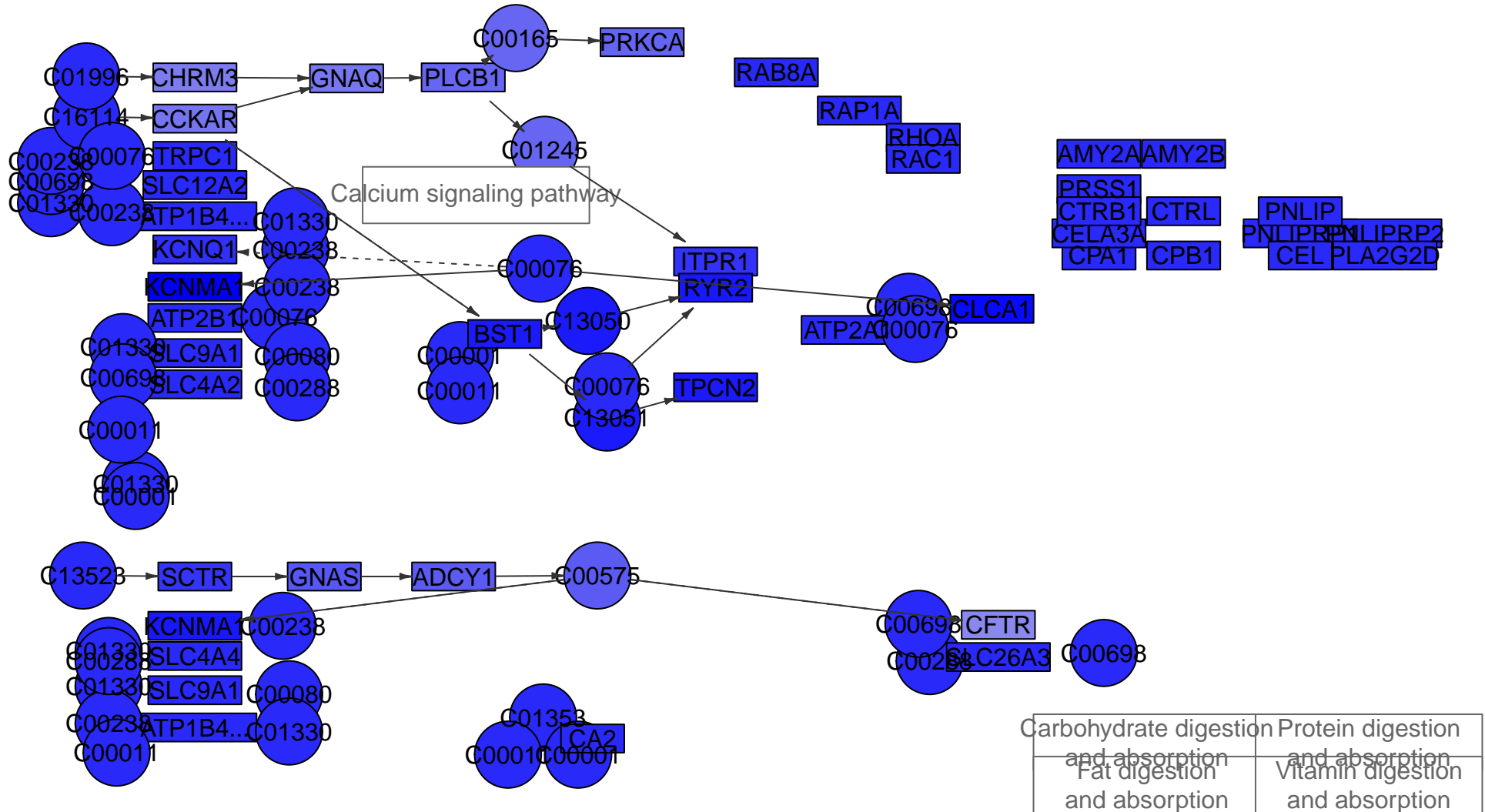

Pancreatic secretion
MPI-251

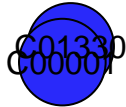

Tight junction

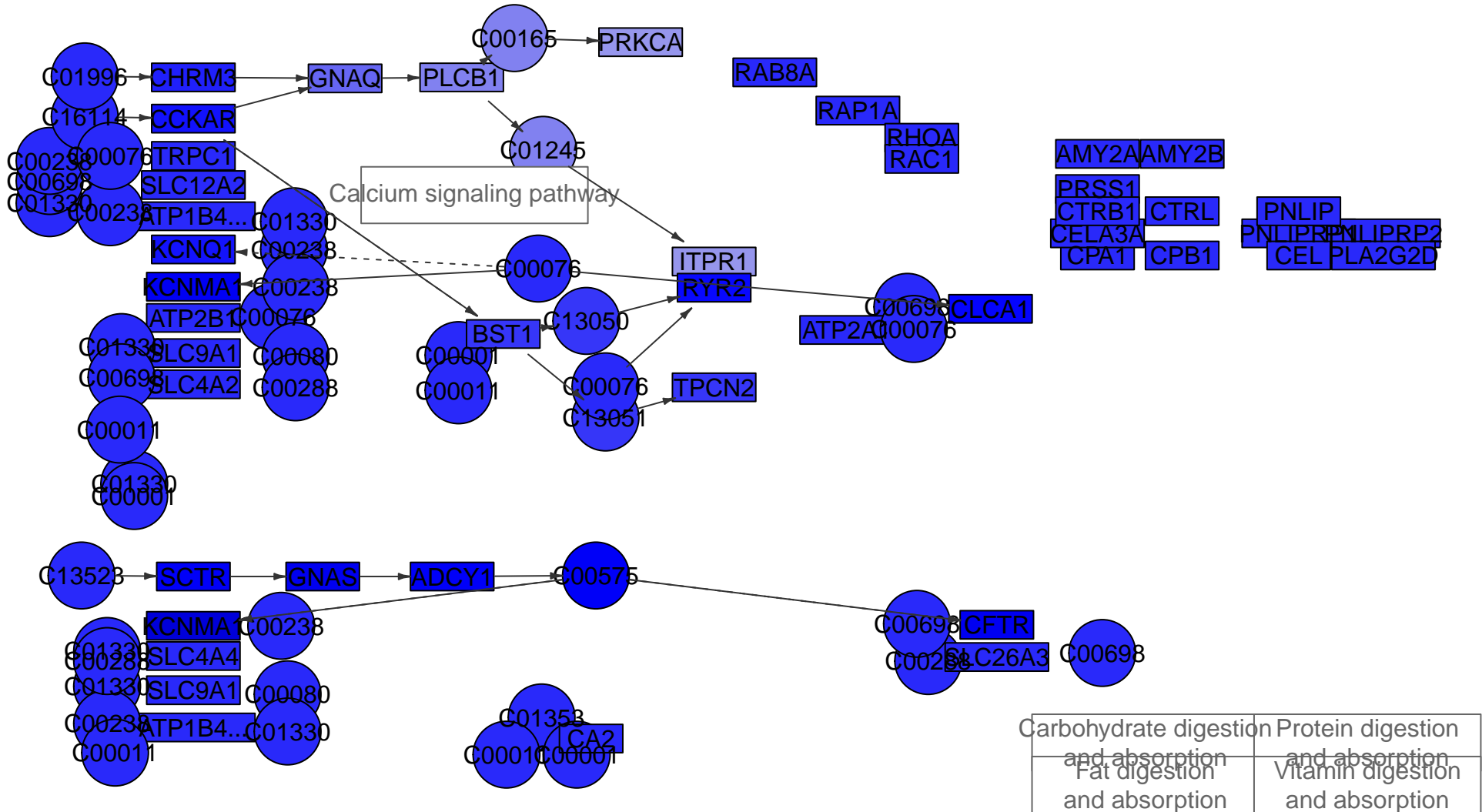

Pancreatic secretion
MPI-255



Tight junction

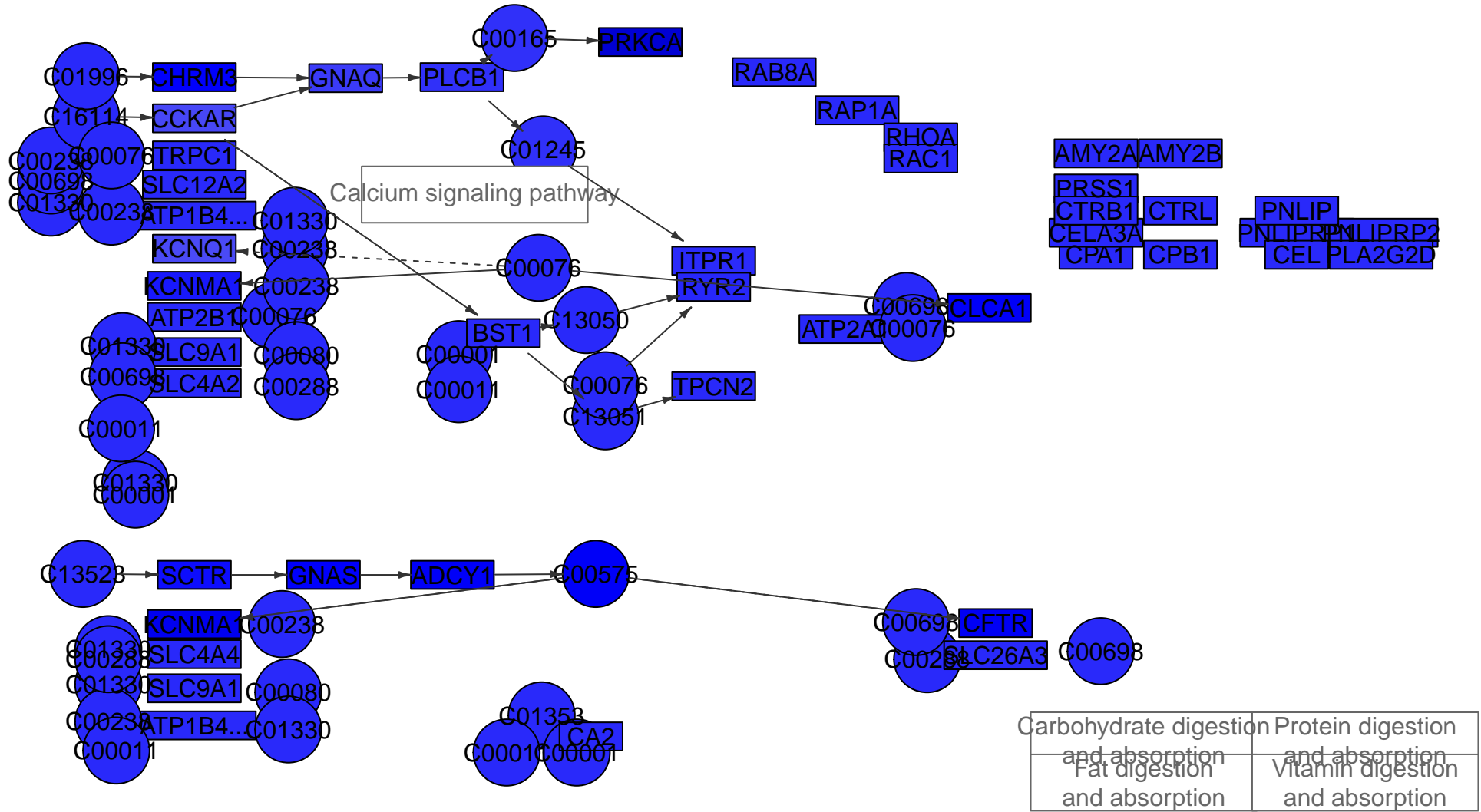

Carbohydrate digestion and absorption	Protein digestion and absorption
Fat digestion and absorption	Vitamin digestion and absorption

Pancreatic secretion
MPI-223b

Tight junction

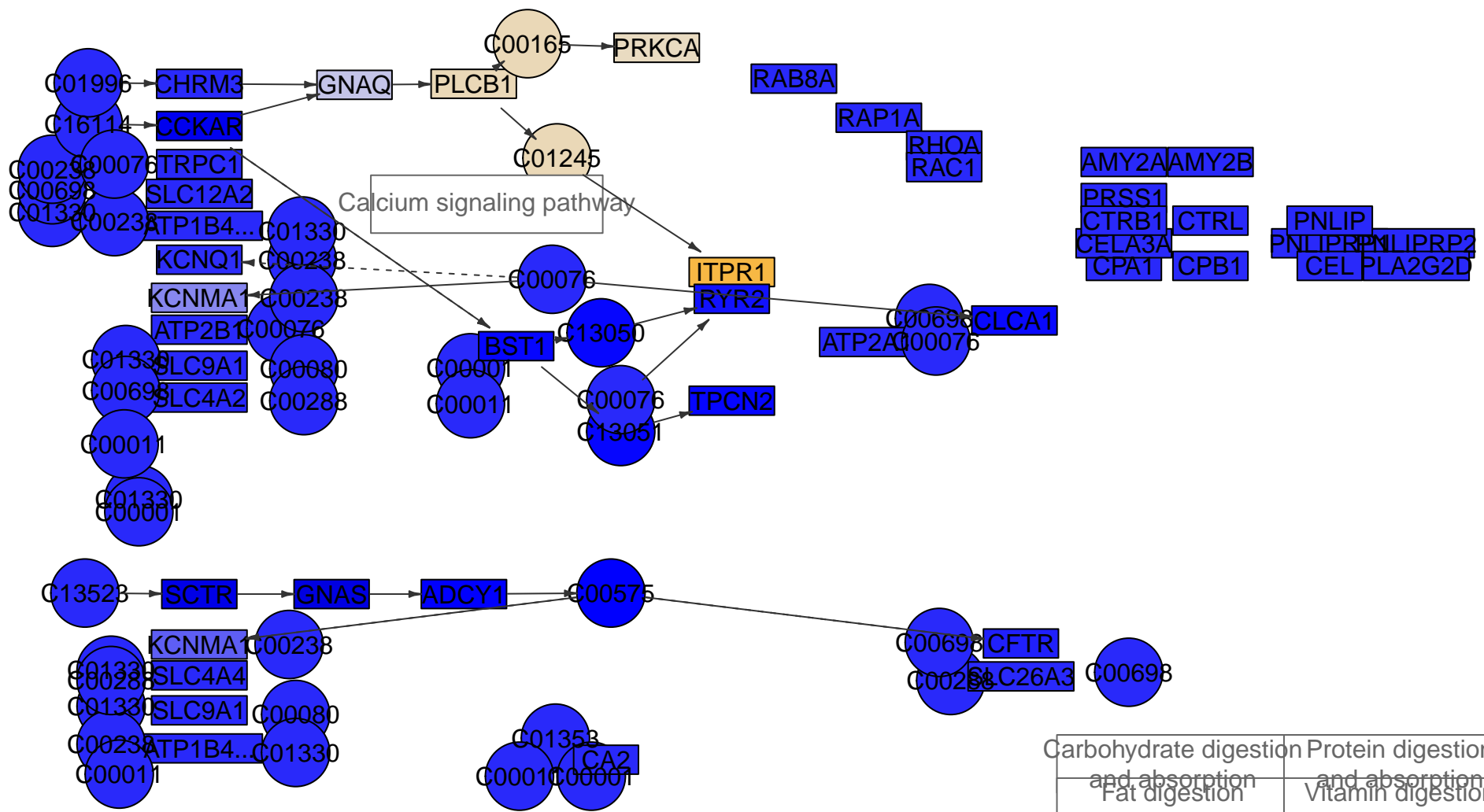

Carbohydrate digestion and absorption	Protein digestion and absorption
Fat digestion and absorption	Vitamin digestion and absorption