

Glycosylphosphatidylinositol(GPI)-a

all genes

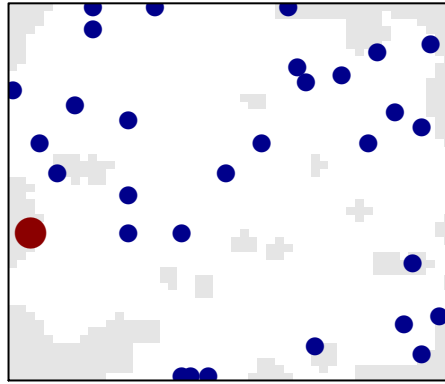

maximum = 2

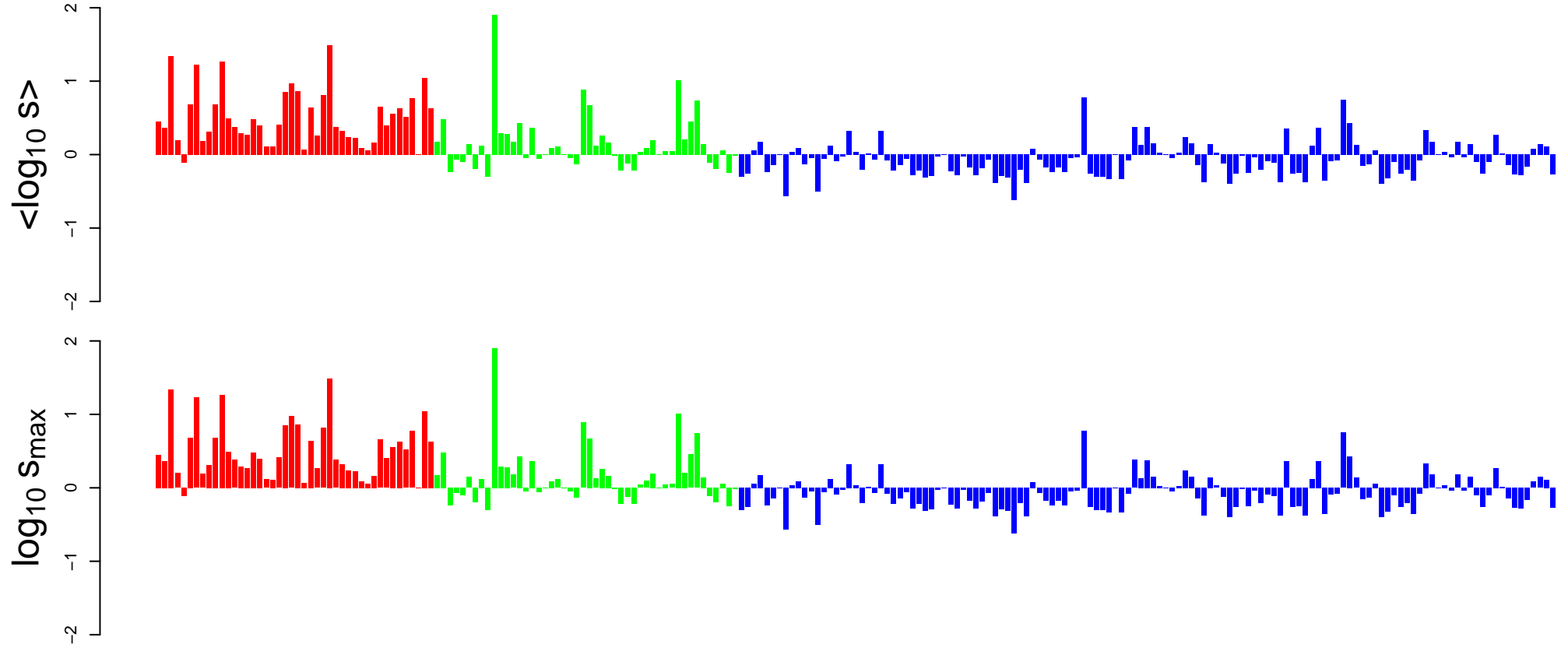

Glycosylphosphatidylinositol(GPI)-anchor
biosynthesis
(genes with data)

Glycerophospholipid
metabolism

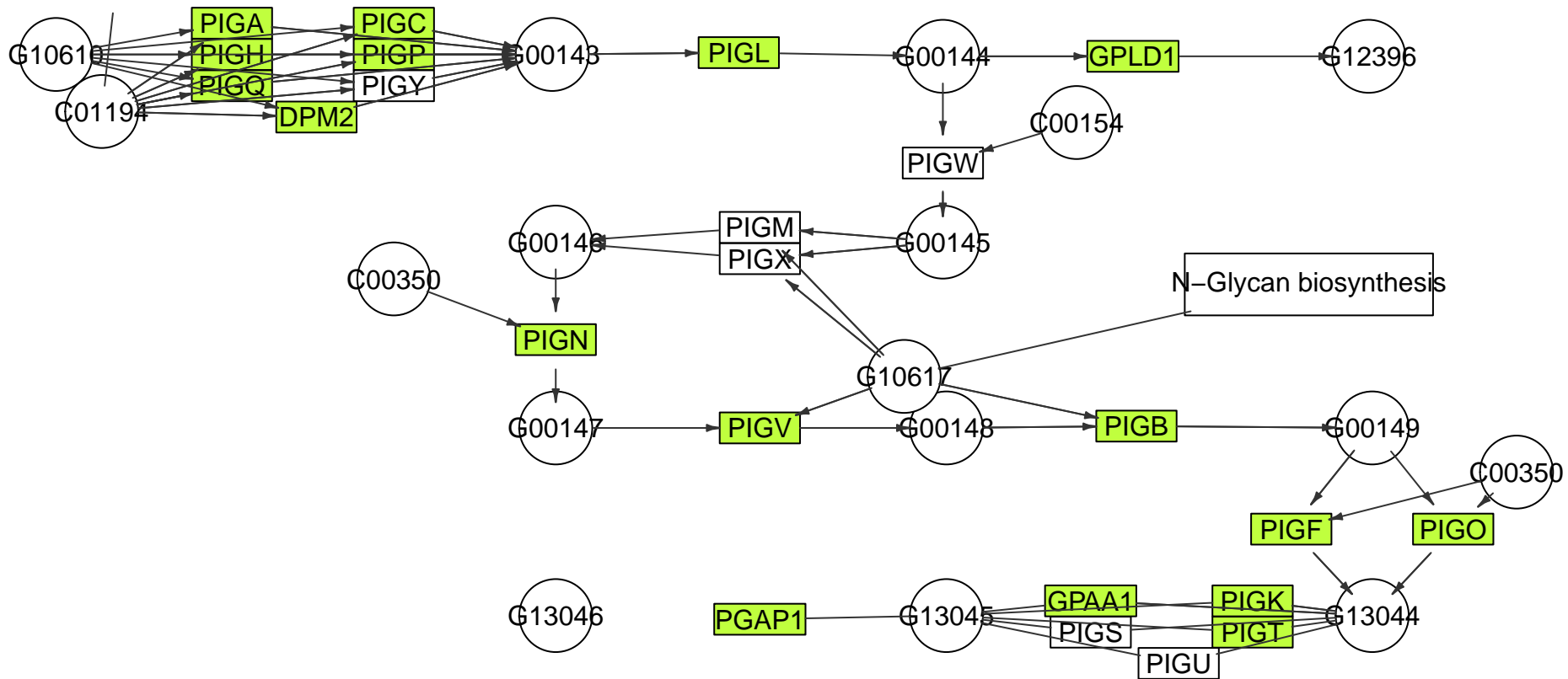

PIGK

PIGO

PIGG

PIGN

PIGZ

PIGB

PIGV

PIGM

PIGA

PIGU

PGAP1

GPAA1

PIGK

PIGT

PIGS

PIGU

PGAP1

Glycosylphosphatidylinositol(GPI)-anchor
biosynthesis
(sink nodes)

Glycerophospholipid
metabolism

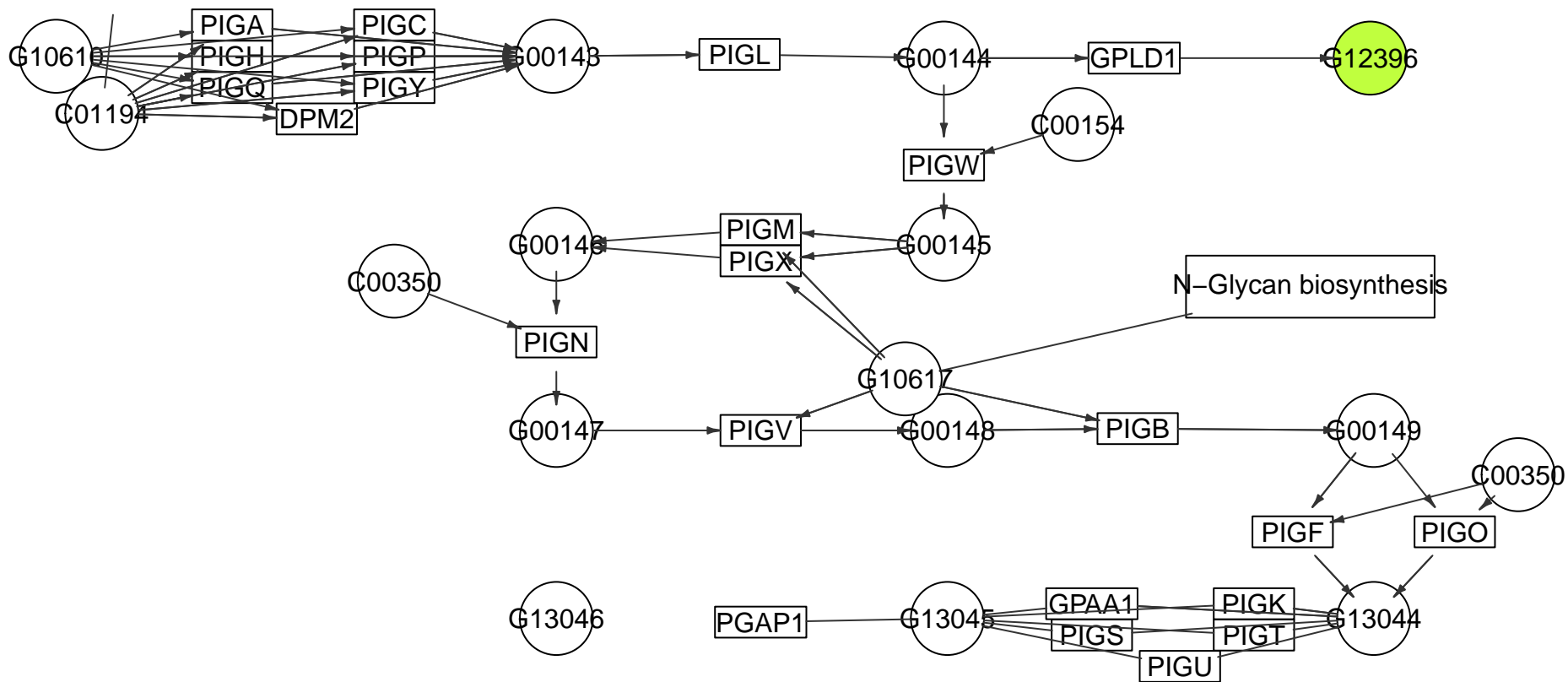

PIGK

PIGO

PIGG

PIGN

PIGZ

PIGB

PIGV

PIGM

PIGA

Glycosylphosphatidylinositol(GPI)-anchor
biosynthesis
MPI-001

Glycerophospholipid
metabolism

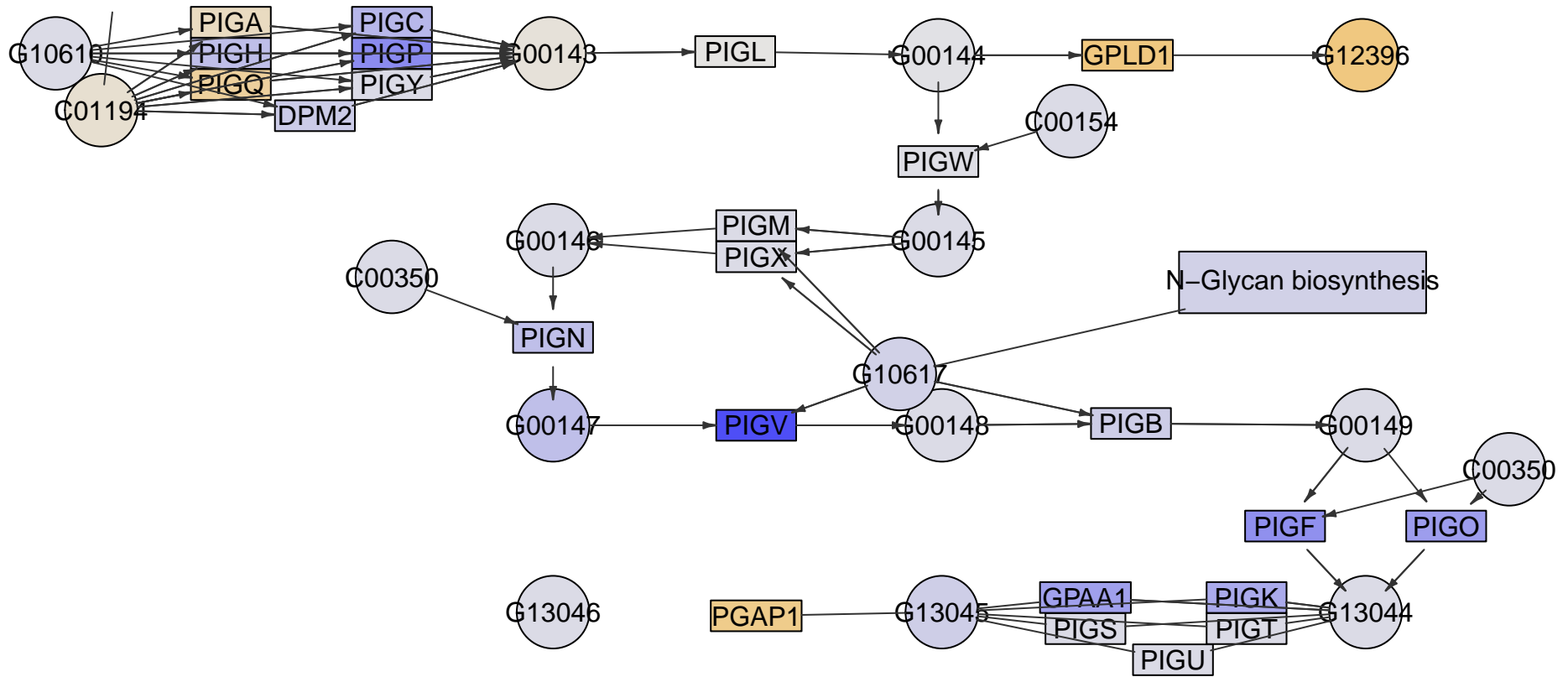

PIGK

PIGO

PIGG

PIGN

PIGZ

PIGB

PIGV

PIGM

PIGA

Glycosylphosphatidylinositol(GPI)-anchor
biosynthesis
MPI-002

Glycerophospholipid
metabolism

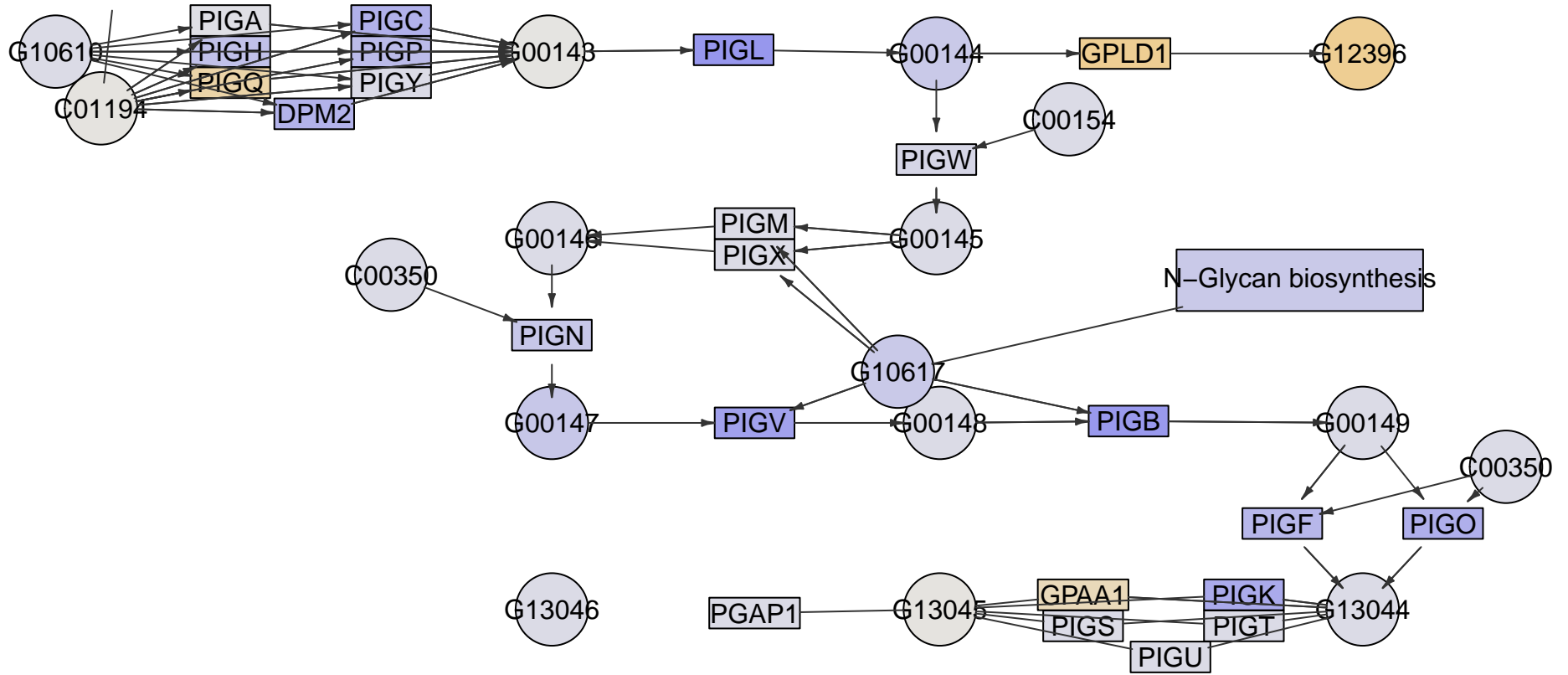

N-Glycan biosynthesis

PIGK

PIGO

PIGG

PIGN

PIGZ

PIGB

PIGV

PIGM

PIGA

Glycosylphosphatidylinositol(GPI)-anchor
biosynthesis
MPI-003

Glycerophospholipid
metabolism

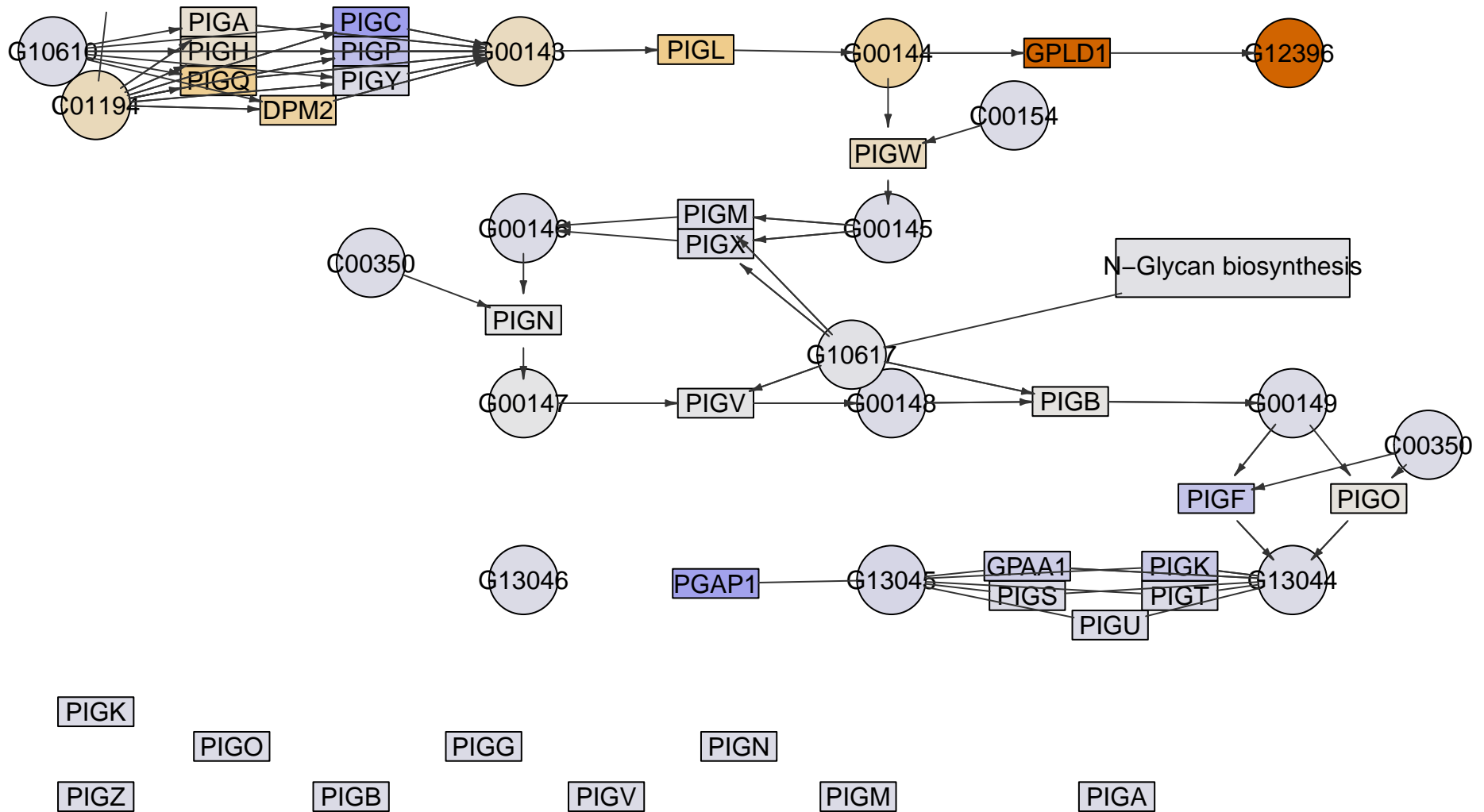

Glycosylphosphatidylinositol(GPI)-anchor
biosynthesis
MPI-005

Glycerophospholipid
metabolism

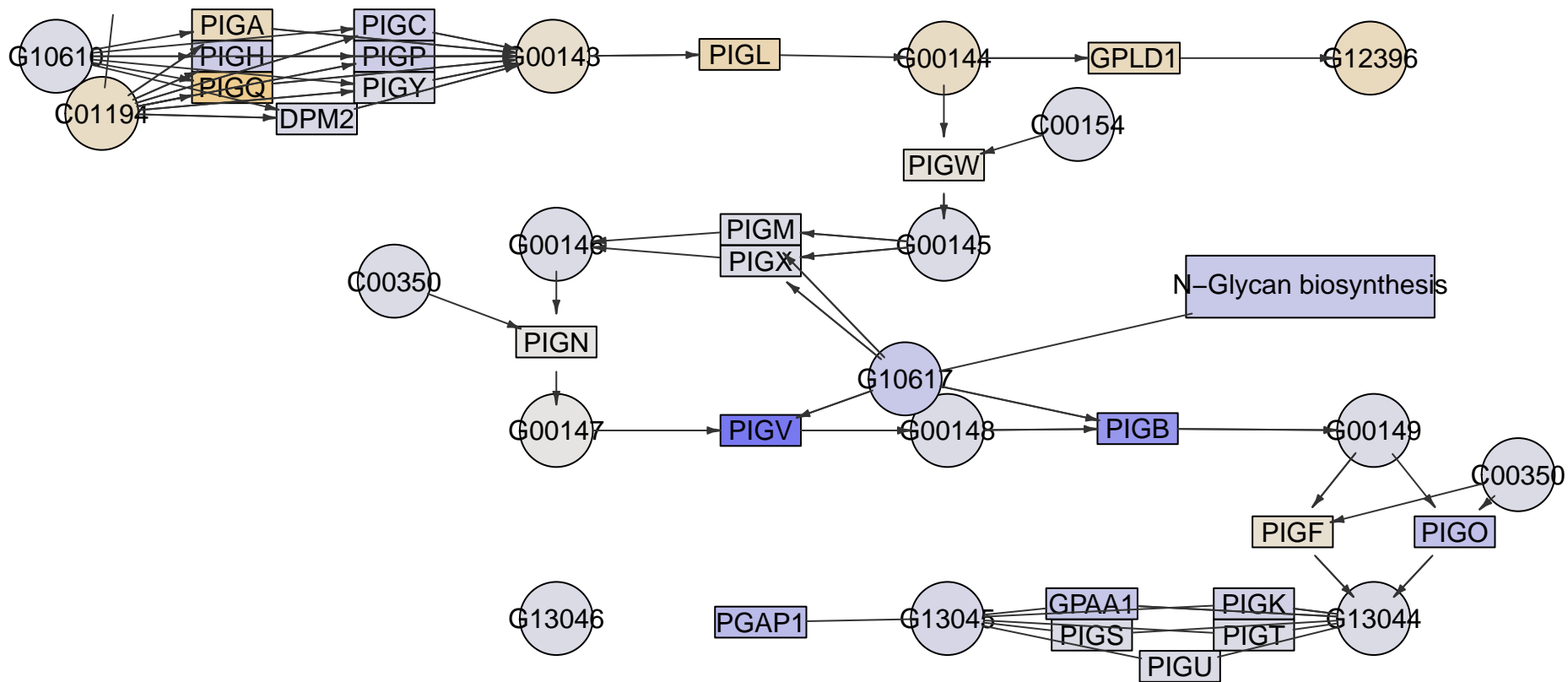

PIGK

PIGO

PIGG

PIGN

PIGZ

PIGB

PIGV

PIGM

PIGA

N-Glycan biosynthesis

Glycosylphosphatidylinositol(GPI)-anchor
biosynthesis
MPI-006

Glycerophospholipid
metabolism

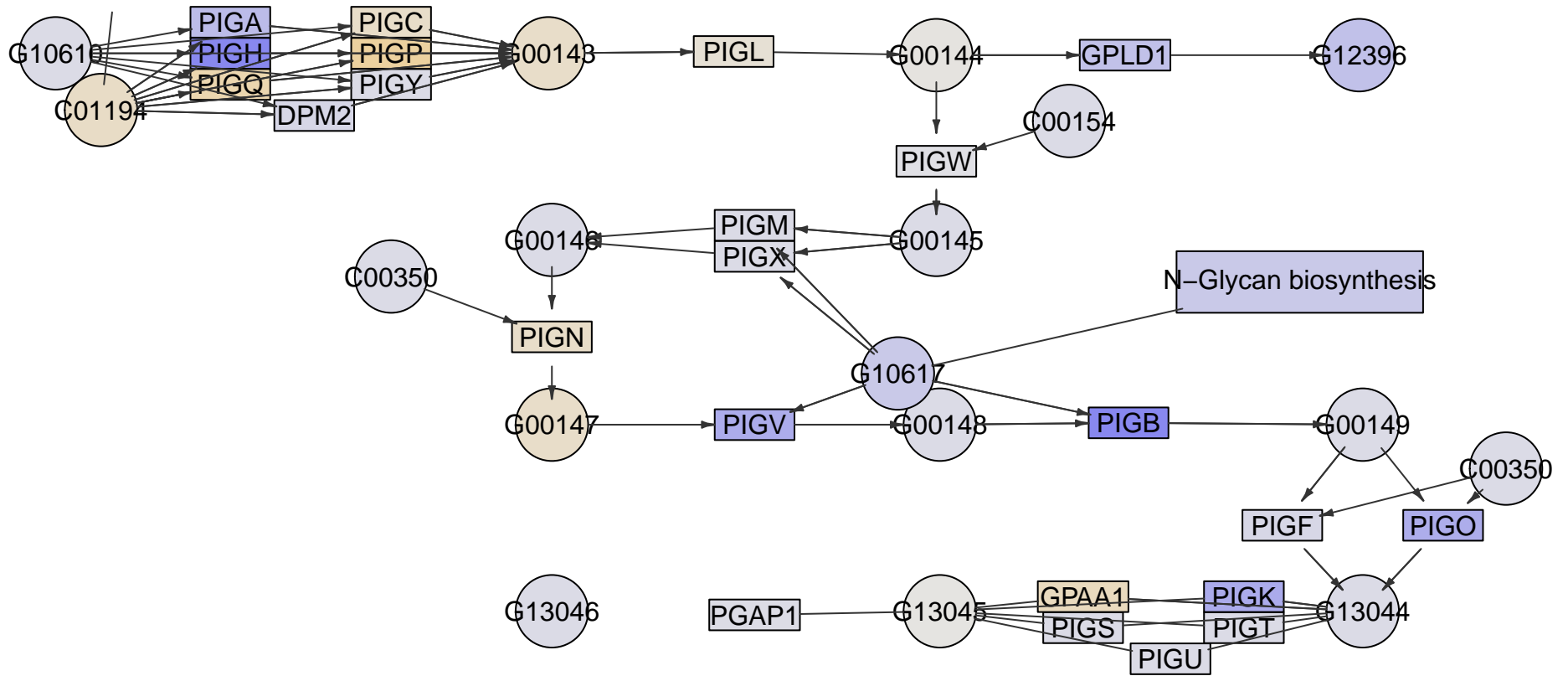

PIGK

PIGO

PIGG

PIGN

PIGZ

PIGB

PIGV

PIGM

PIGA

Glycosylphosphatidylinositol(GPI)-anchor
biosynthesis
MPI-016

Glycerophospholipid
metabolism

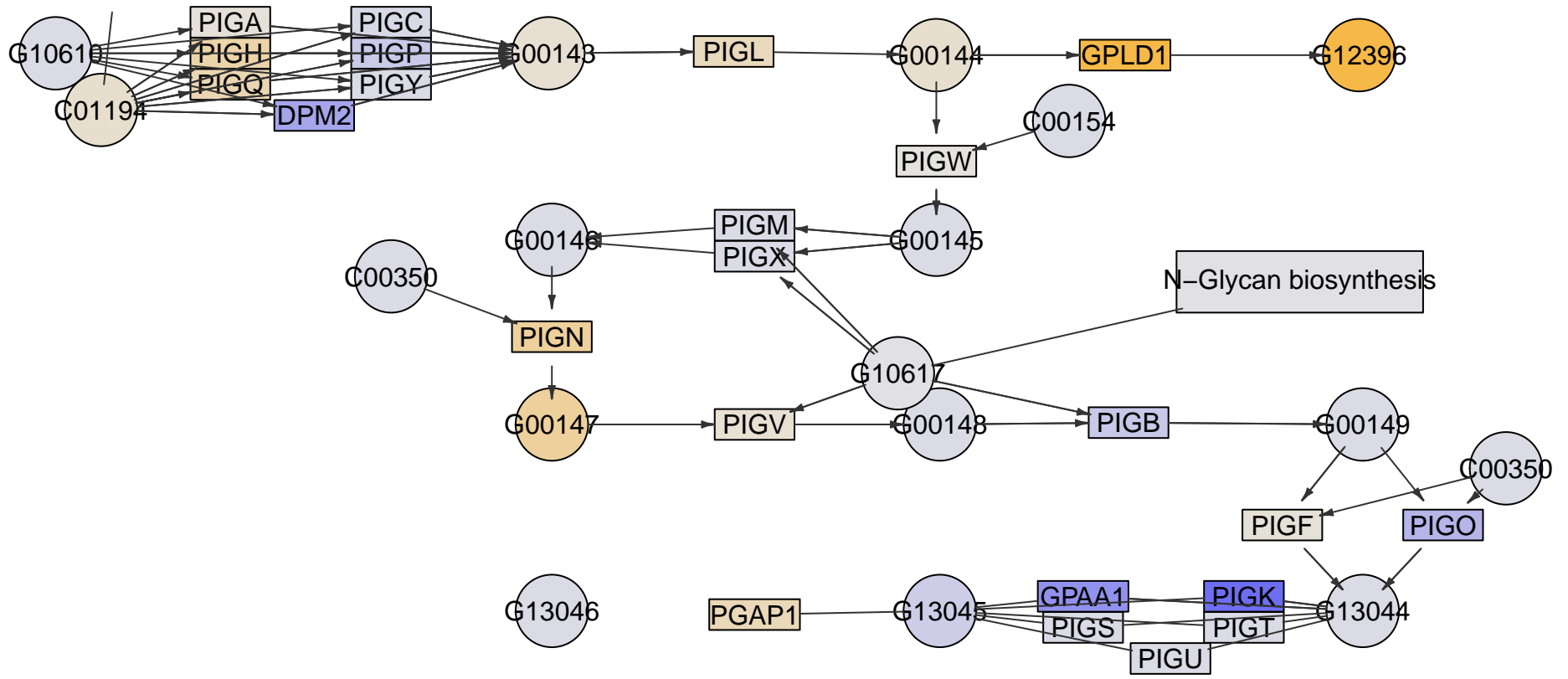

PIGK

PIGO

PIGG

PIGN

PIGZ

PIGB

PIGV

PIGM

PIGA

Glycosylphosphatidylinositol(GPI)-anchor
biosynthesis
MPI-017

Glycerophospholipid
metabolism

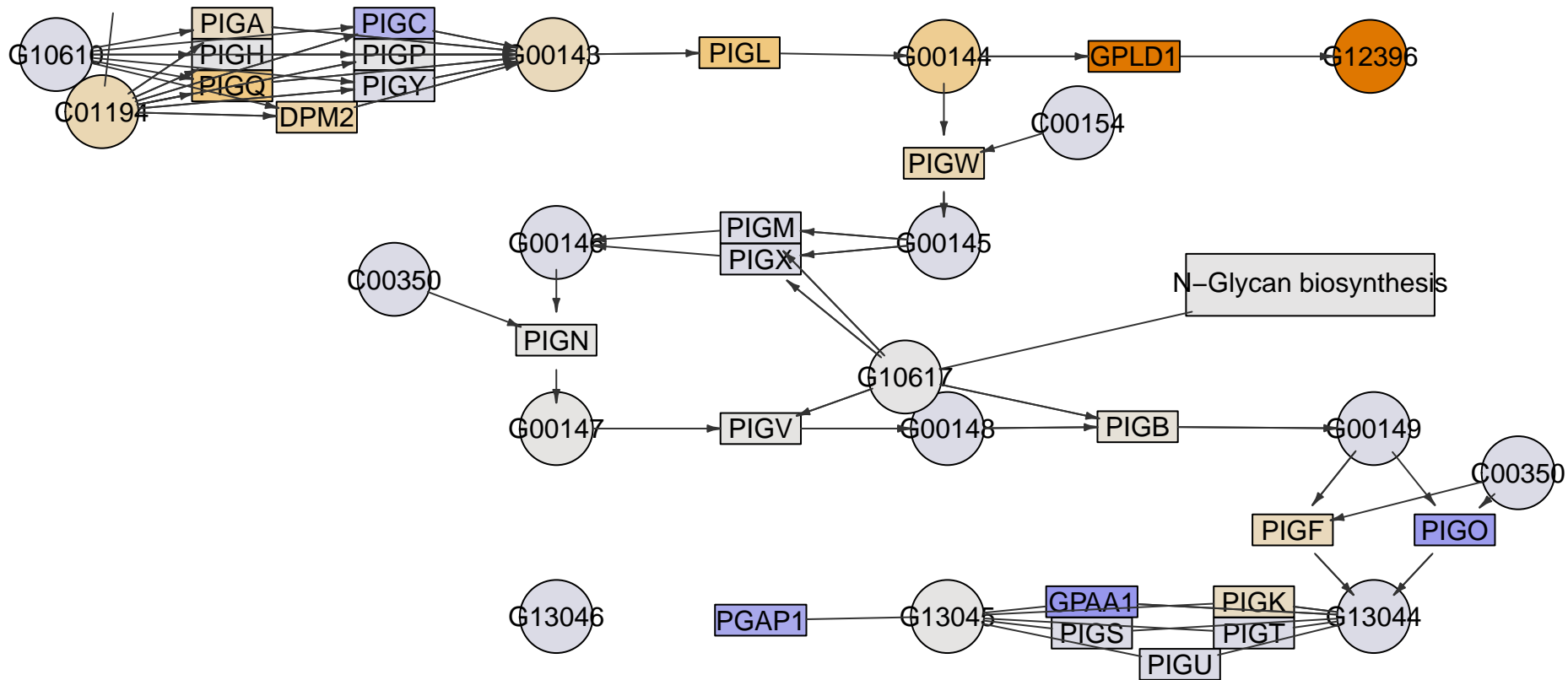

PIGK

PIGO

PIGG

PIGN

PIGZ

PIGB

PIGV

PIGM

PIGA

Glycosylphosphatidylinositol(GPI)-anchor
biosynthesis
MPI-018

Glycerophospholipid
metabolism

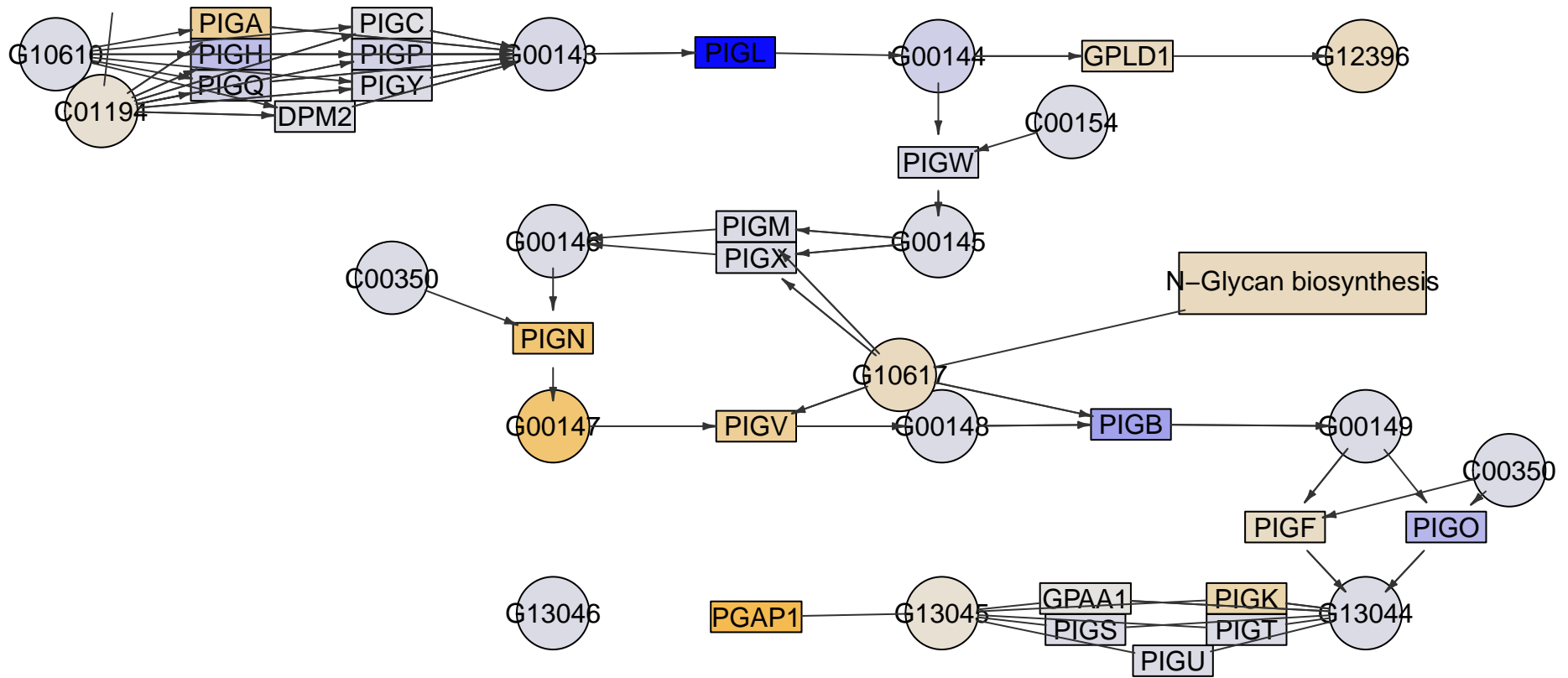

N-Glycan biosynthesis

PIGK

PIGO

PIGG

PIGN

PIGZ

PIGB

PIGV

PIGM

PIGA

Glycosylphosphatidylinositol(GPI)-anchor
biosynthesis
MPI-027

Glycerophospholipid
metabolism

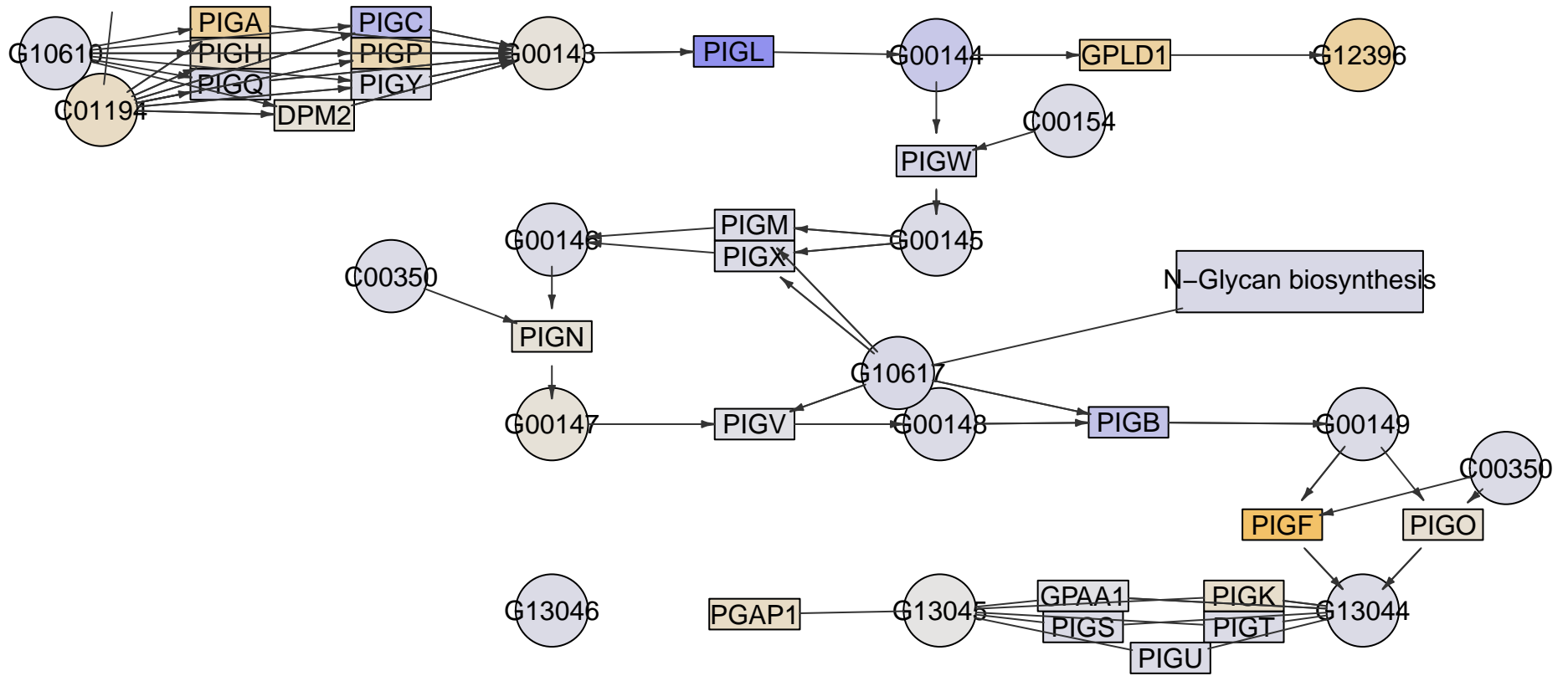

PIGK

PIGO

PIGG

PIGN

PIGZ

PIGB

PIGV

PIGM

PIGA

Glycosylphosphatidylinositol(GPI)-anchor
biosynthesis
MPI-028

Glycerophospholipid
metabolism

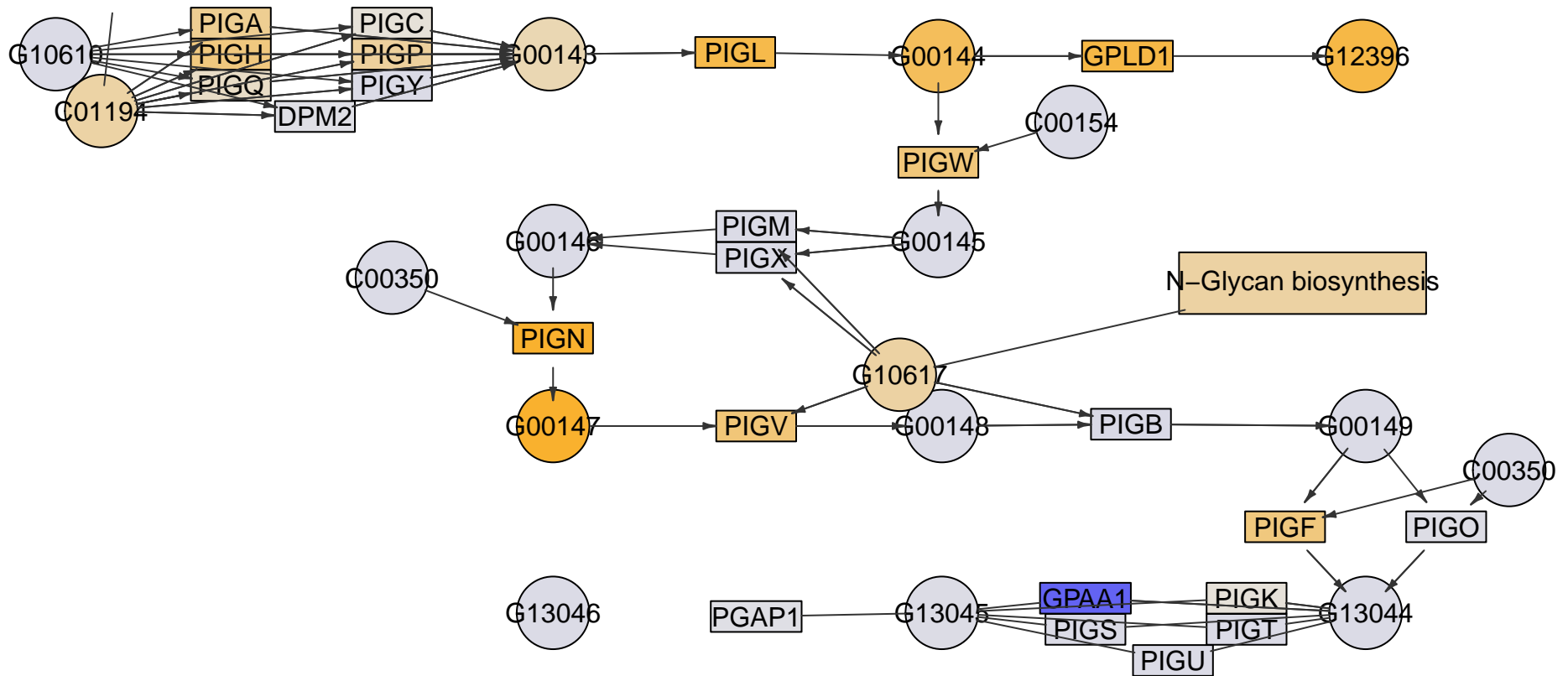

PIGK

PIGO

PIGG

PIGN

PIGZ

PIGB

PIGV

PIGM

PIGA

Glycosylphosphatidylinositol(GPI)-anchor
biosynthesis
MPI-032

Glycerophospholipid
metabolism

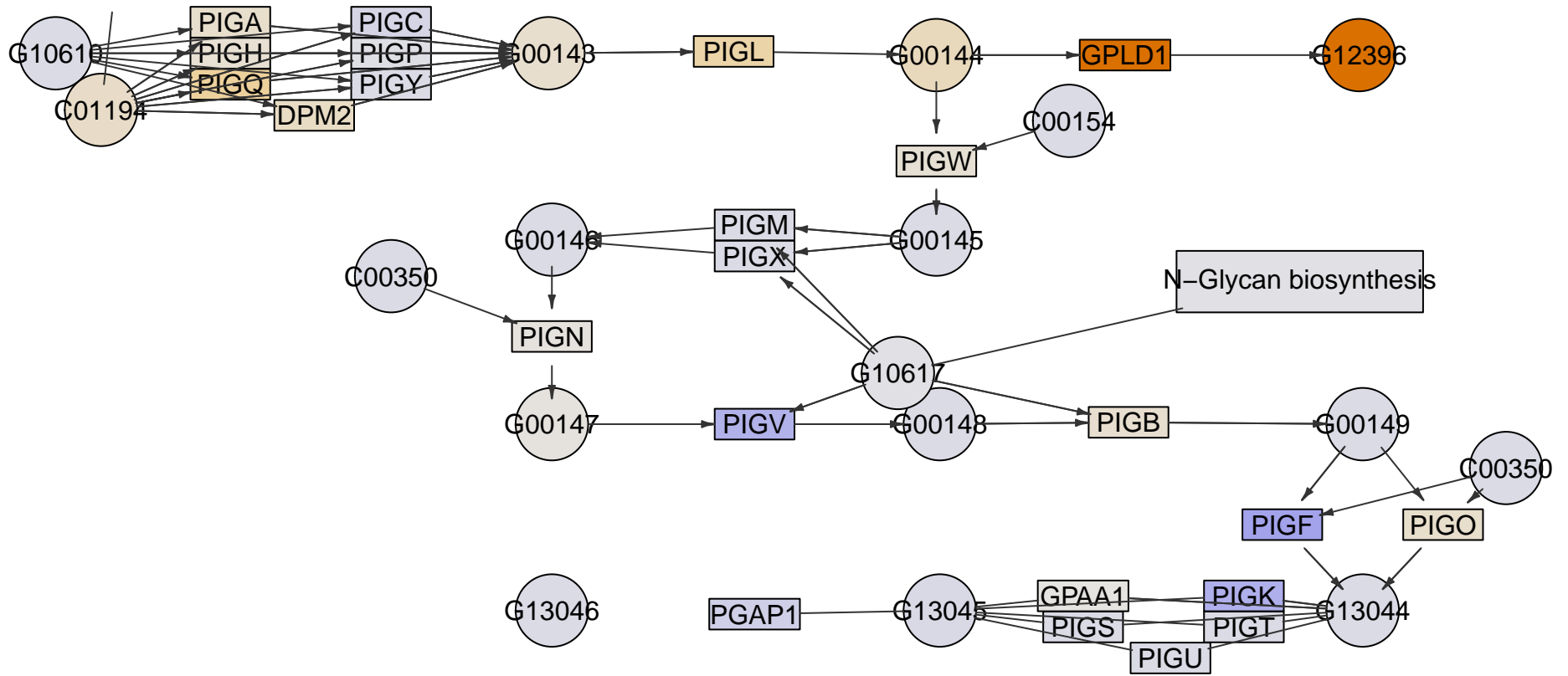

PIGK

PIGO

PIGG

PIGN

PIGZ

PIGB

PIGV

PIGM

PIGA

Glycosylphosphatidylinositol(GPI)-anchor
biosynthesis
MPI-033

Glycerophospholipid
metabolism

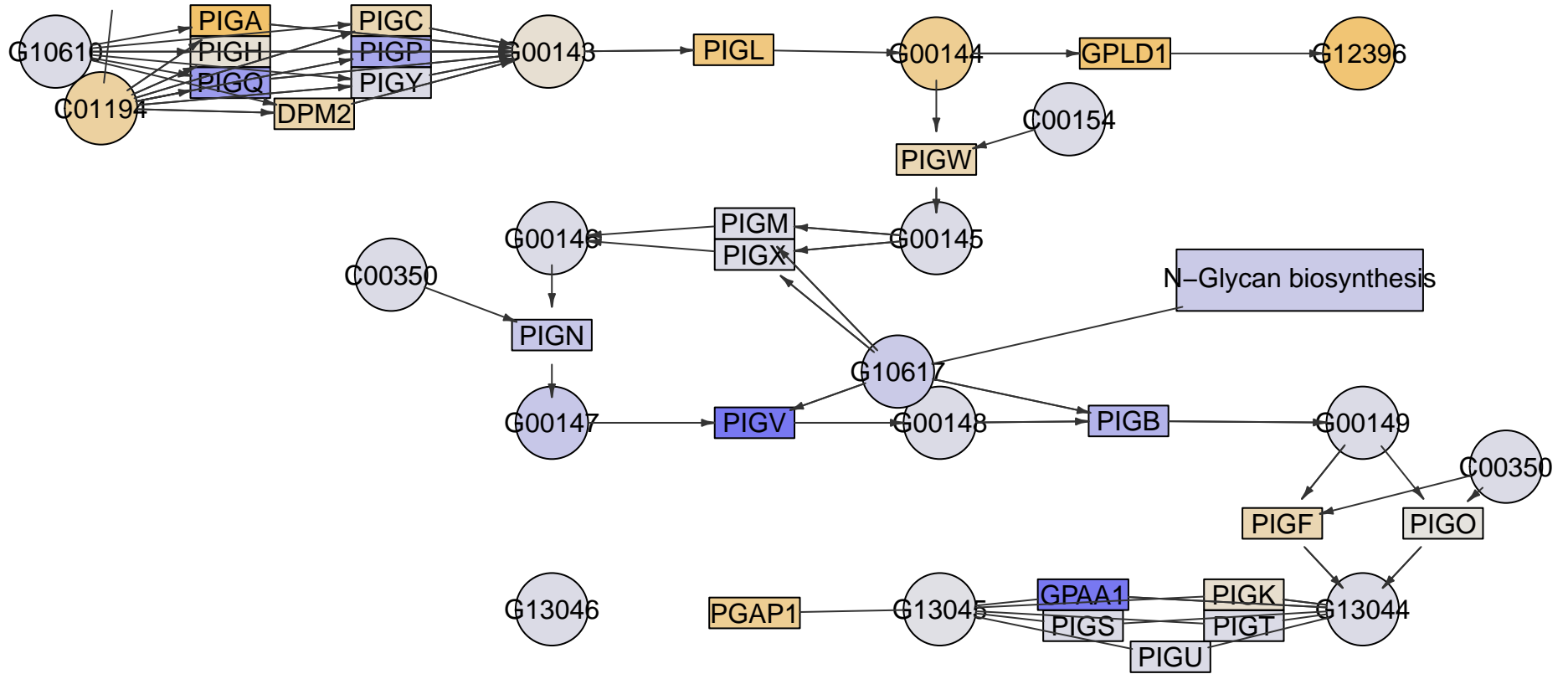

N-Glycan biosynthesis

PIGK

PIGO

PIGG

PIGN

PIGZ

PIGB

PIGV

PIGM

PIGA

Glycosylphosphatidylinositol(GPI)-anchor
biosynthesis
MPI-034

Glycerophospholipid
metabolism

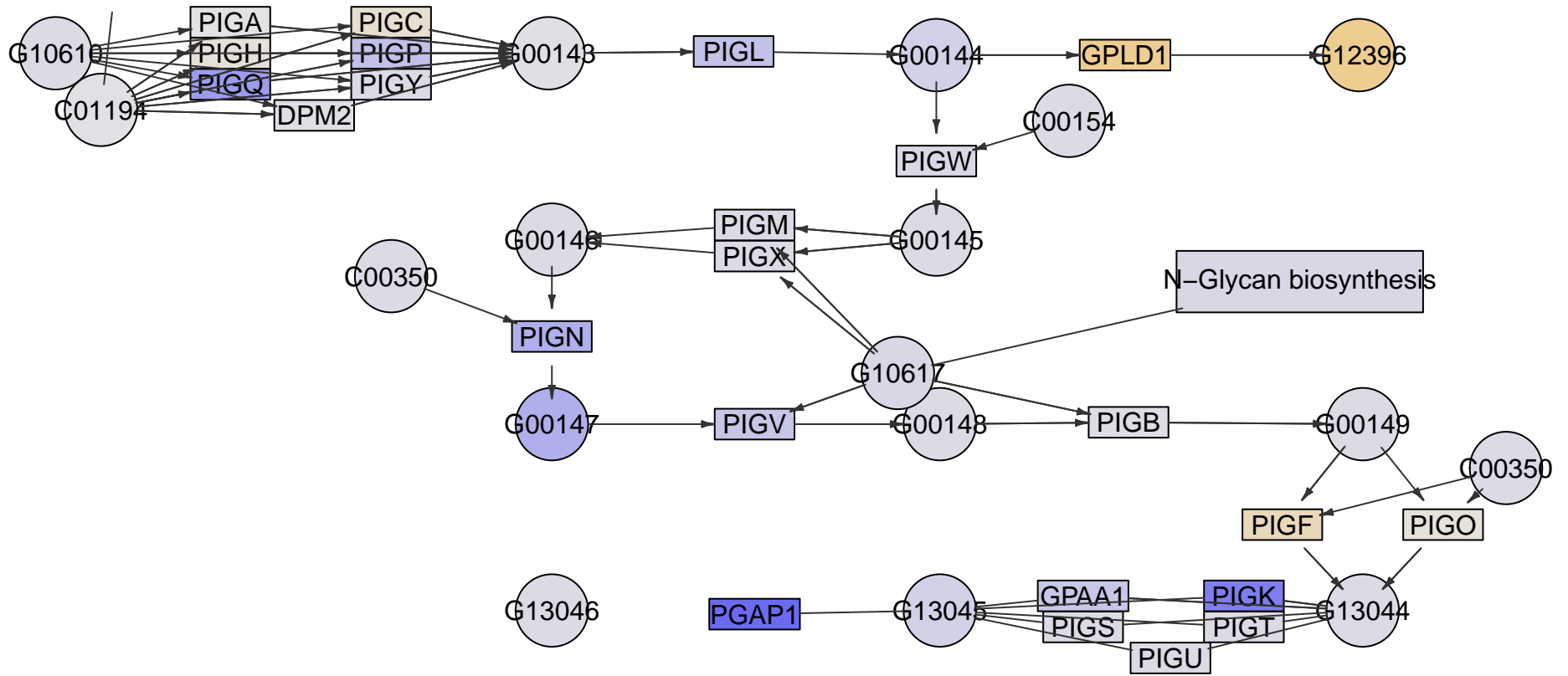

PIGK

PIGO

PIGG

PIGN

PIGZ

PIGB

PIGV

PIGM

PIGA

Glycosylphosphatidylinositol(GPI)-anchor
biosynthesis
MPI-043

Glycerophospholipid
metabolism

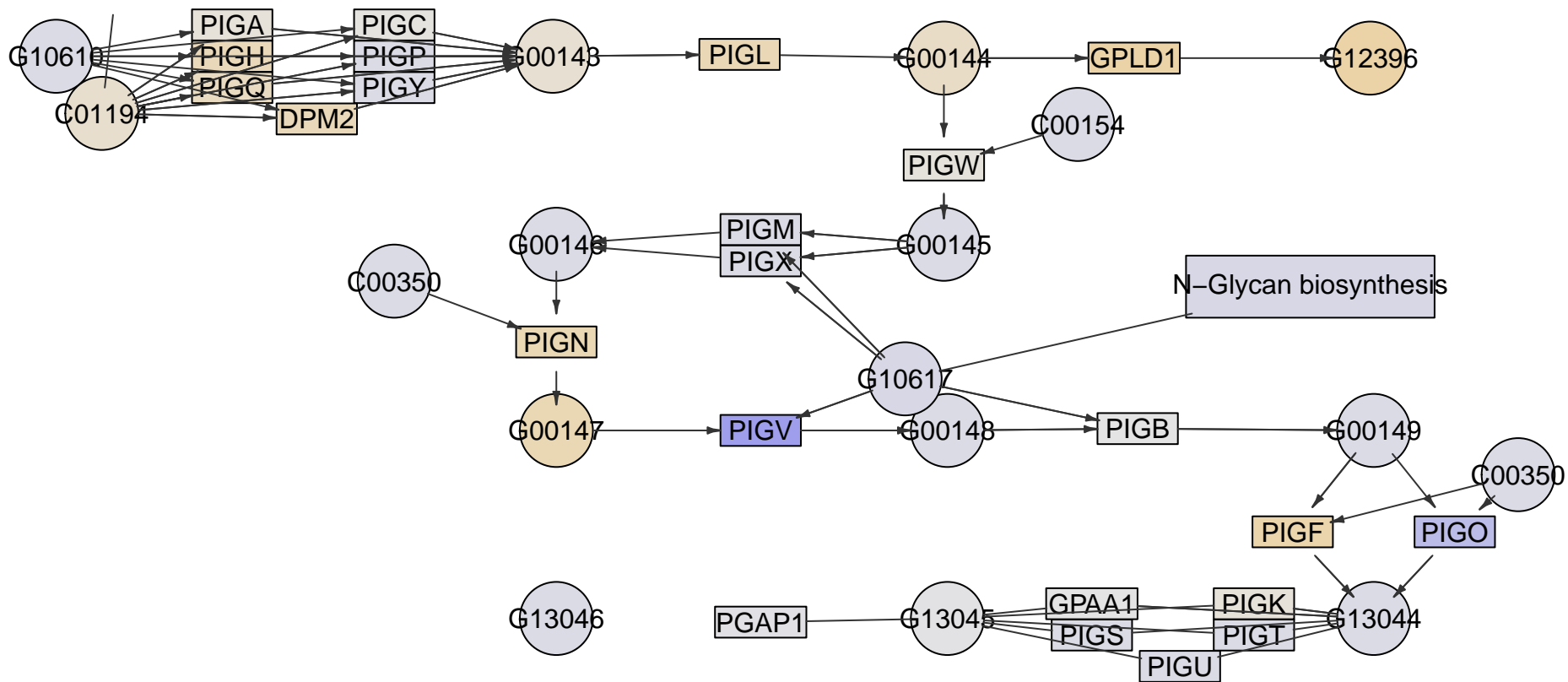

N-Glycan biosynthesis

PIGK

PIGO

PIGG

PIGN

PIGZ

PIGB

PIGV

PIGM

PIGA

Glycosylphosphatidylinositol(GPI)-anchor
biosynthesis
MPI-044

Glycerophospholipid
metabolism

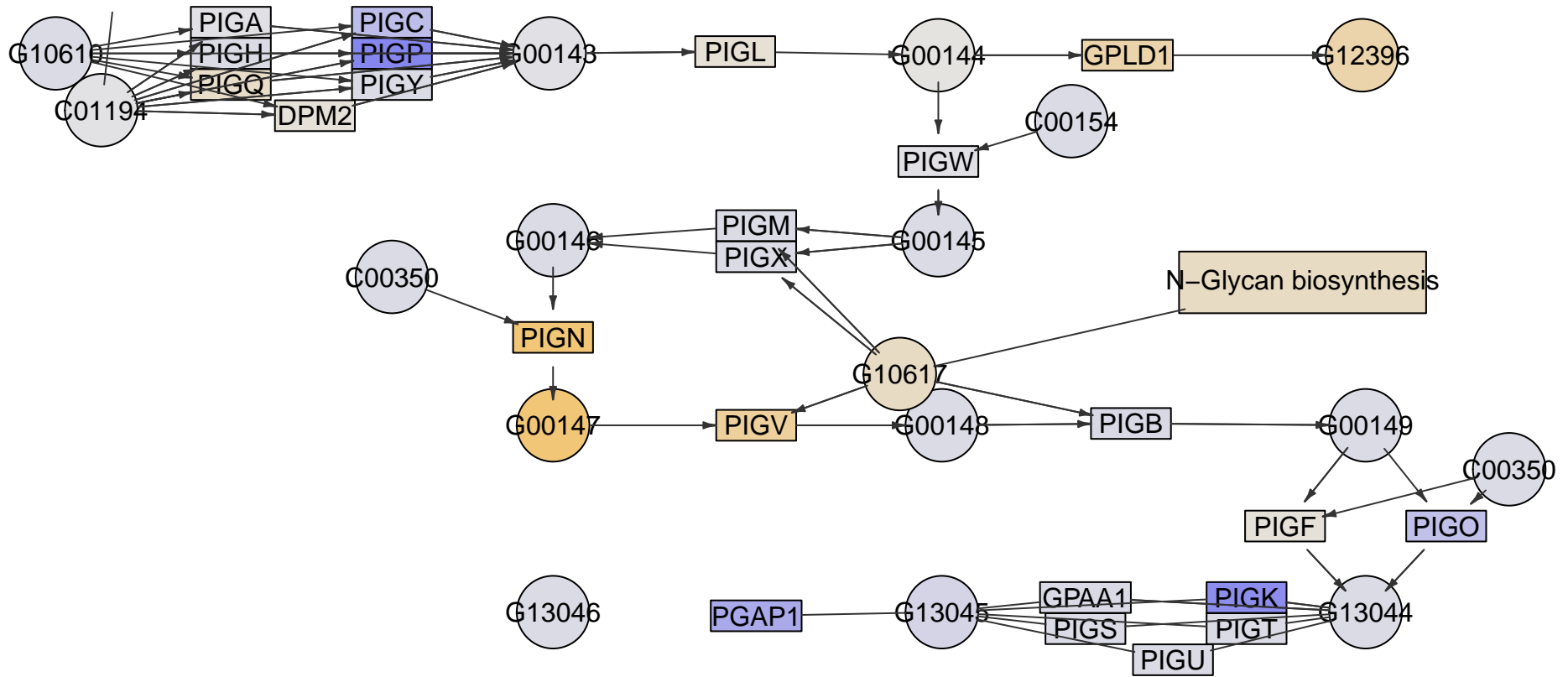

PIGK

PIGO

PIGG

PIGN

PIGZ

PIGB

PIGV

PIGM

PIGA

Glycosylphosphatidylinositol(GPI)-anchor
biosynthesis
MPI-048

Glycerophospholipid
metabolism

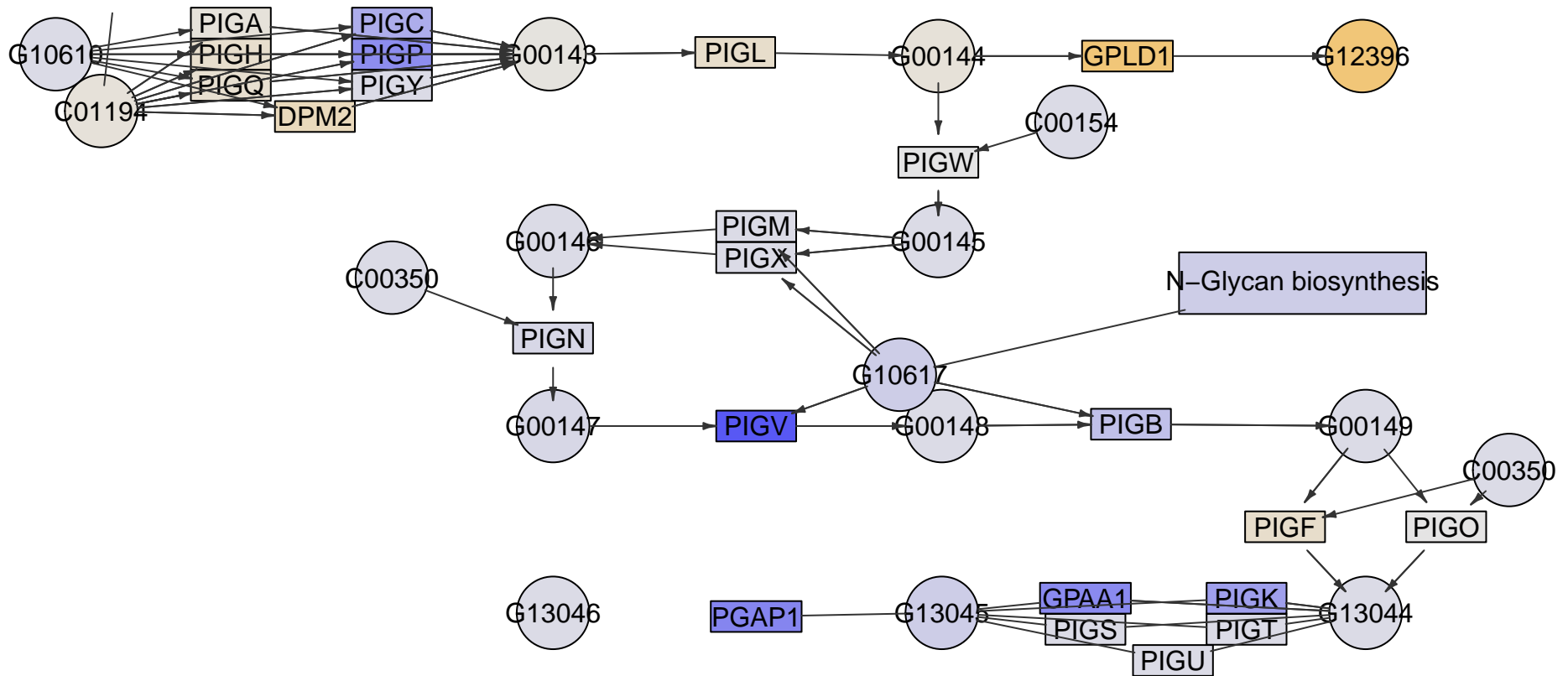

N-Glycan biosynthesis

PIGK

PIGO

PIGG

PIGN

PIGZ

PIGB

PIGV

PIGM

PIGA

Glycosylphosphatidylinositol(GPI)-anchor
biosynthesis
MPI-055

Glycerophospholipid
metabolism

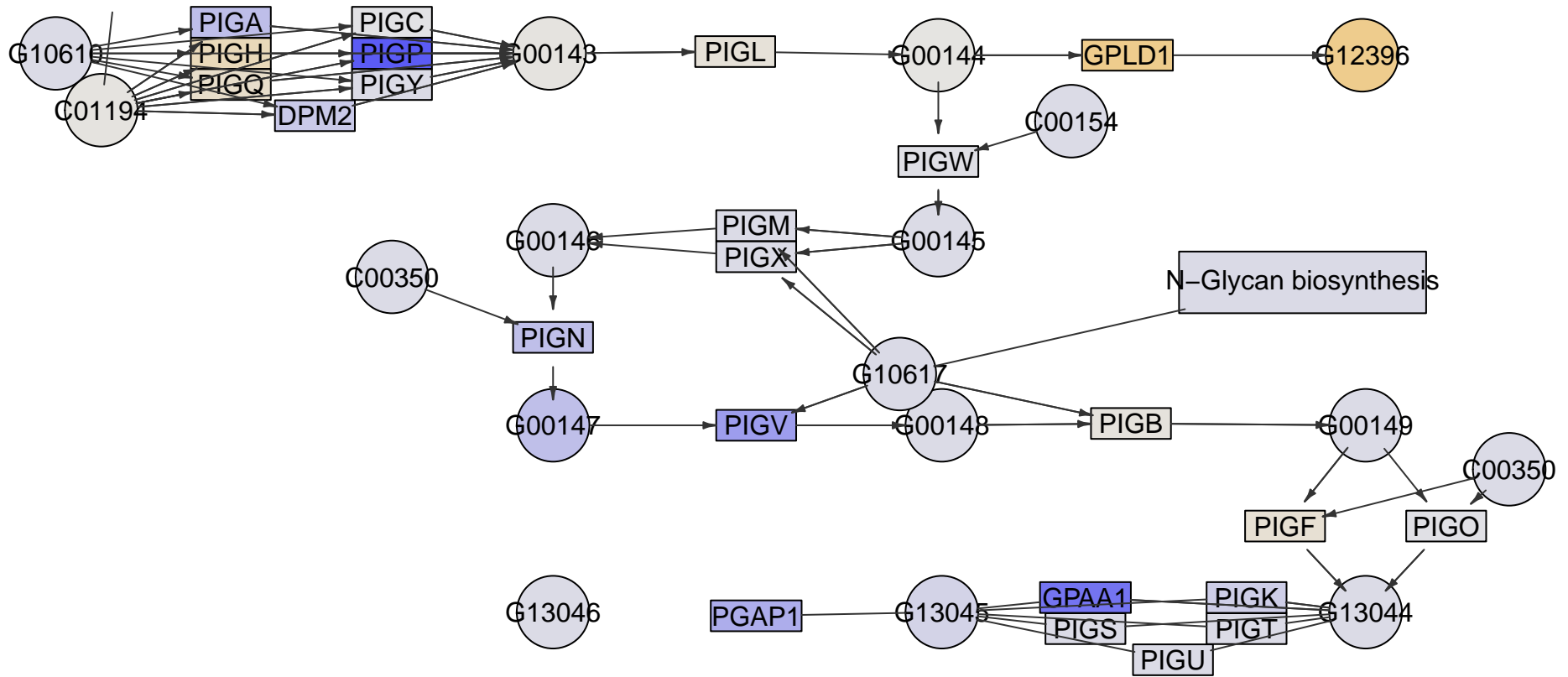

PIGK

PIGO

PIGG

PIGN

PIGZ

PIGB

PIGV

PIGM

PIGA

Glycosylphosphatidylinositol(GPI)-anchor
biosynthesis
MPI-065

Glycerophospholipid
metabolism

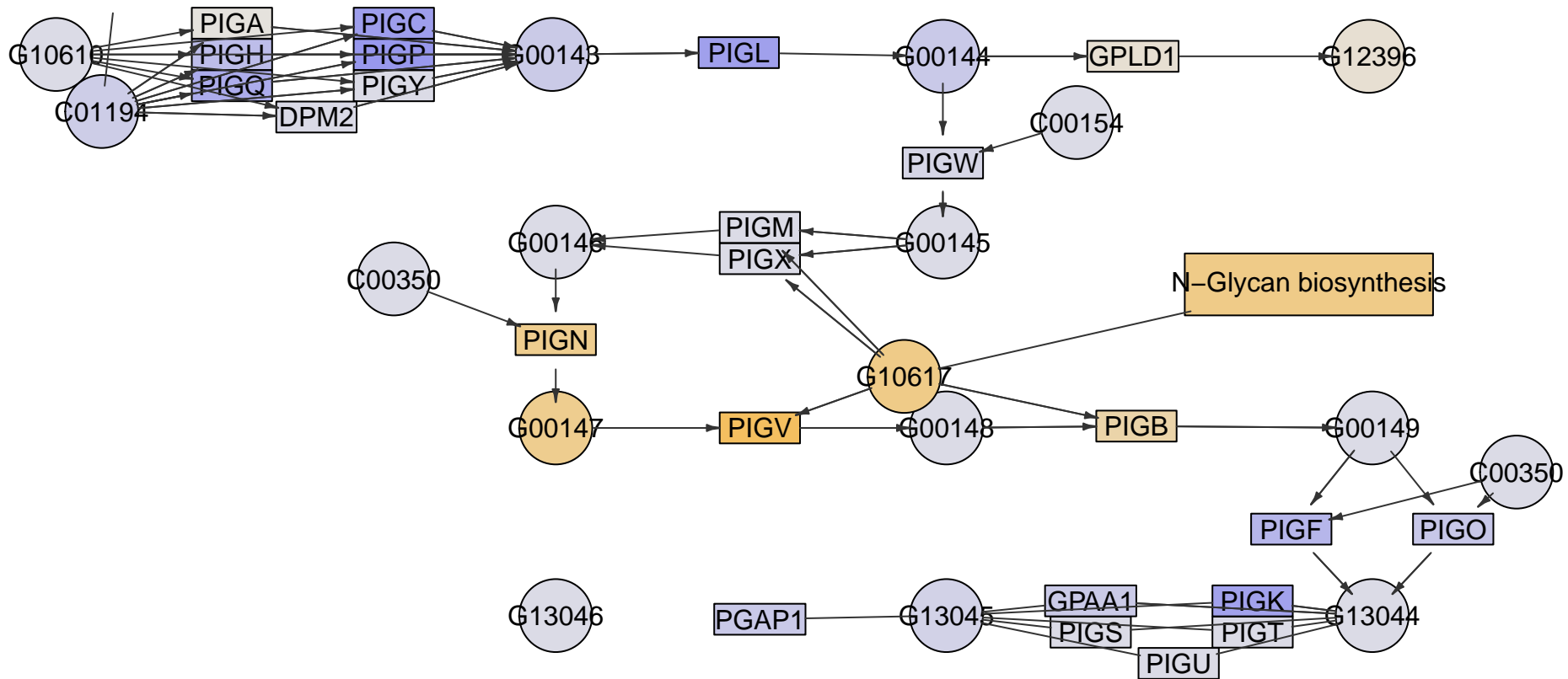

N-Glycan biosynthesis

PIGK

PIGO

PIGG

PIGN

PIGZ

PIGB

PIGV

PIGM

PIGA

Glycosylphosphatidylinositol(GPI)-anchor
biosynthesis
MPI-071

Glycerophospholipid
metabolism

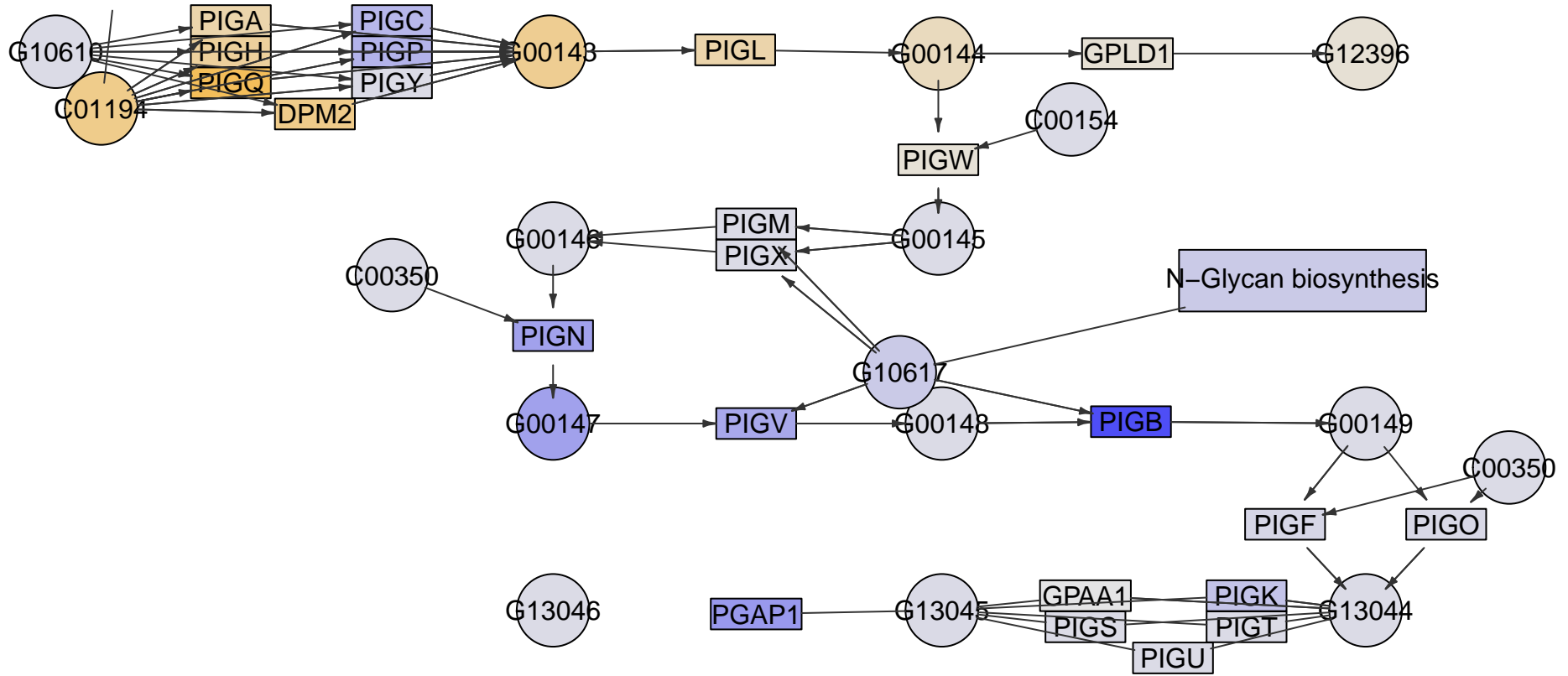

PIGK

PIGO

PIGG

PIGN

PIGZ

PIGB

PIGV

PIGM

PIGA

Glycosylphosphatidylinositol(GPI)-anchor
biosynthesis
MPI-075

Glycerophospholipid
metabolism

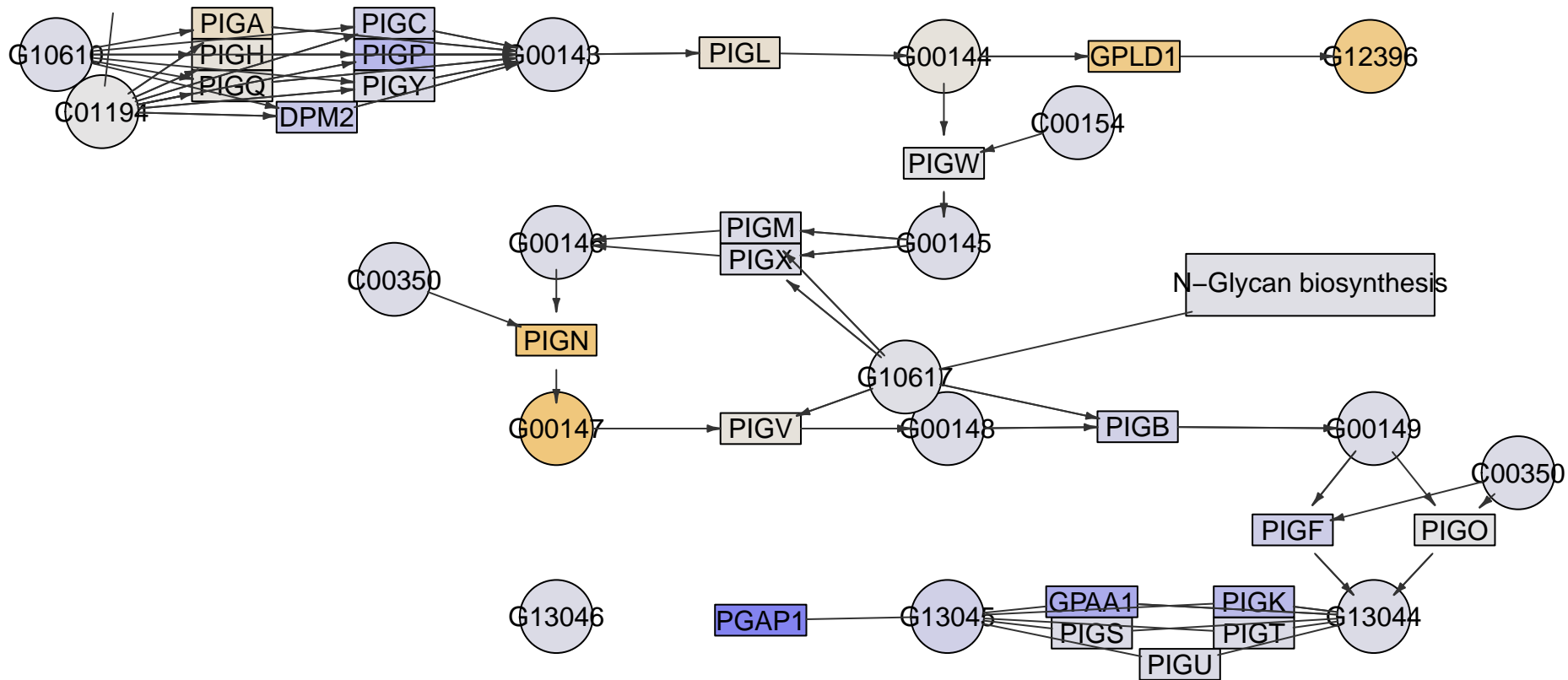

PIGK

PIGO

PIGG

PIGN

PIGZ

PIGB

PIGV

PIGM

PIGA

Glycosylphosphatidylinositol(GPI)-anchor
biosynthesis
MPI-077

Glycerophospholipid
metabolism

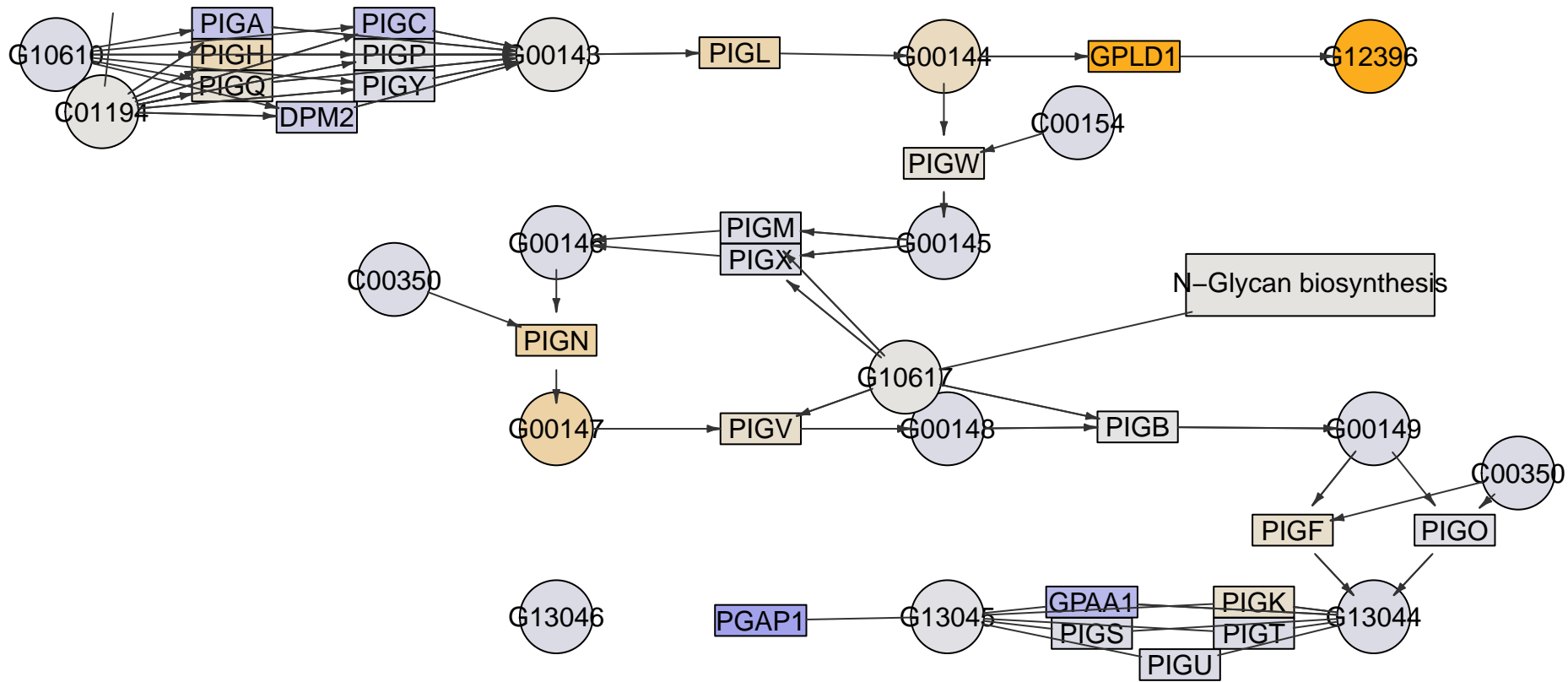

PIGK

PIGO

PIGG

PIGN

PIGZ

PIGB

PIGV

PIGM

PIGA

Glycosylphosphatidylinositol(GPI)-anchor
biosynthesis
MPI-078

Glycerophospholipid
metabolism

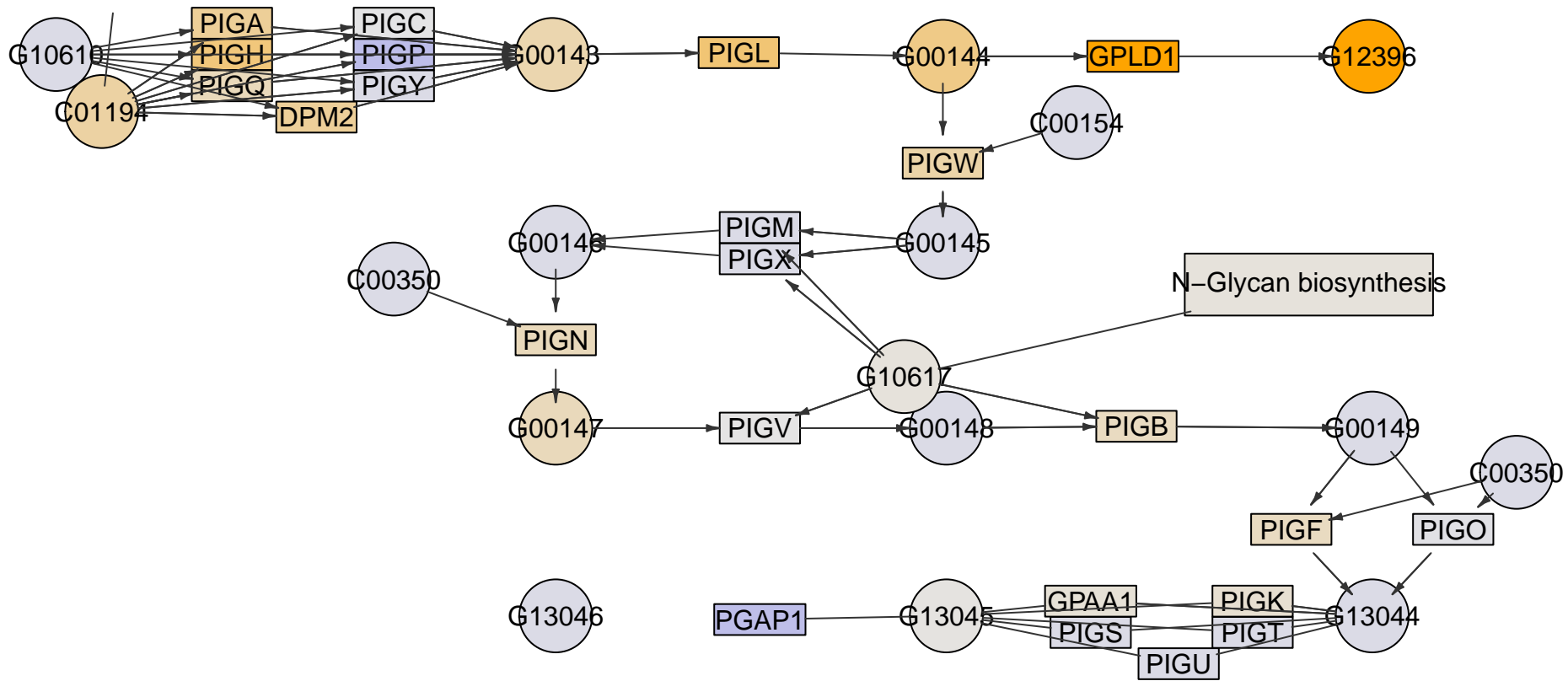

PIGK

PIGO

PIGG

PIGN

PIGZ

PIGB

PIGV

PIGM

PIGA

Glycosylphosphatidylinositol(GPI)-anchor
biosynthesis
MPI-079

Glycerophospholipid
metabolism

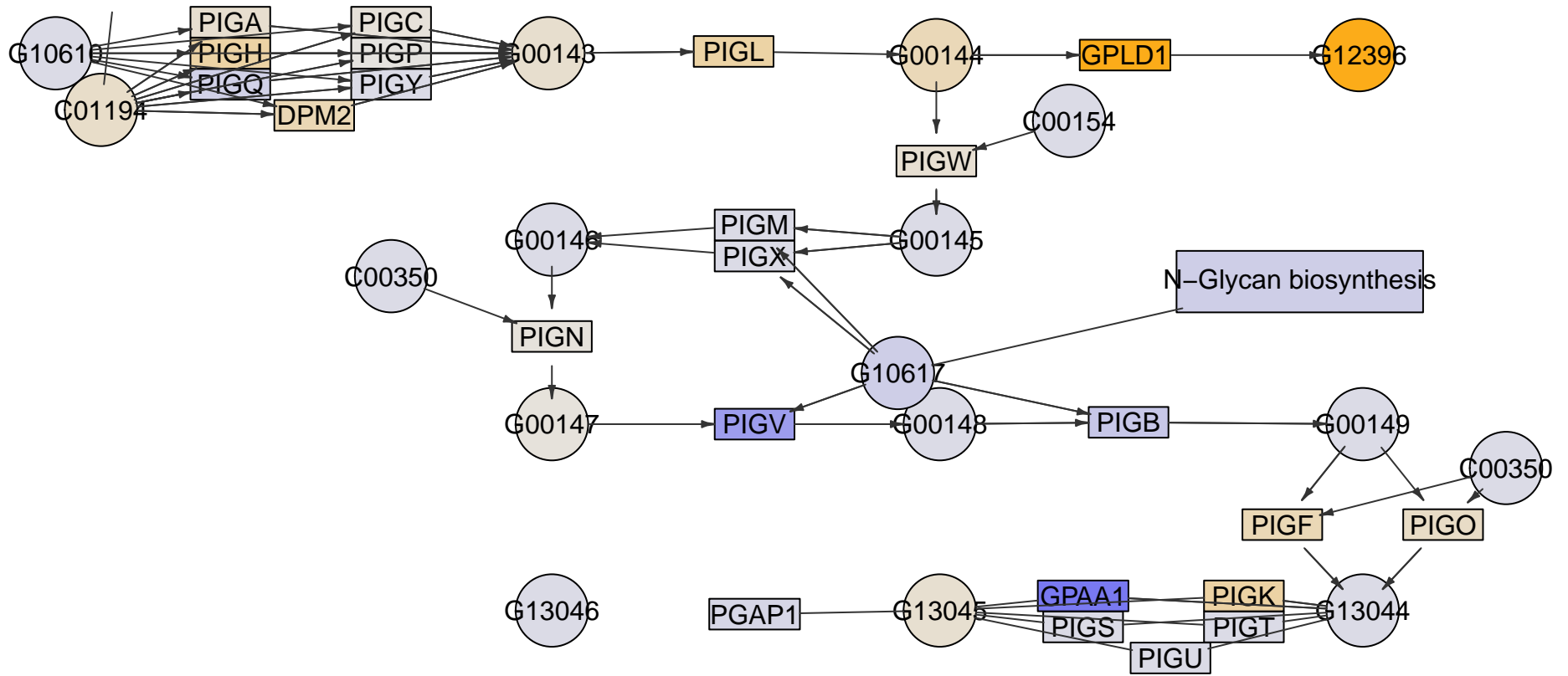

PIGK

PIGO

PIGG

PIGN

PIGZ

PIGB

PIGV

PIGM

PIGA

Glycosylphosphatidylinositol(GPI)-anchor
biosynthesis
MPI-080

Glycerophospholipid
metabolism

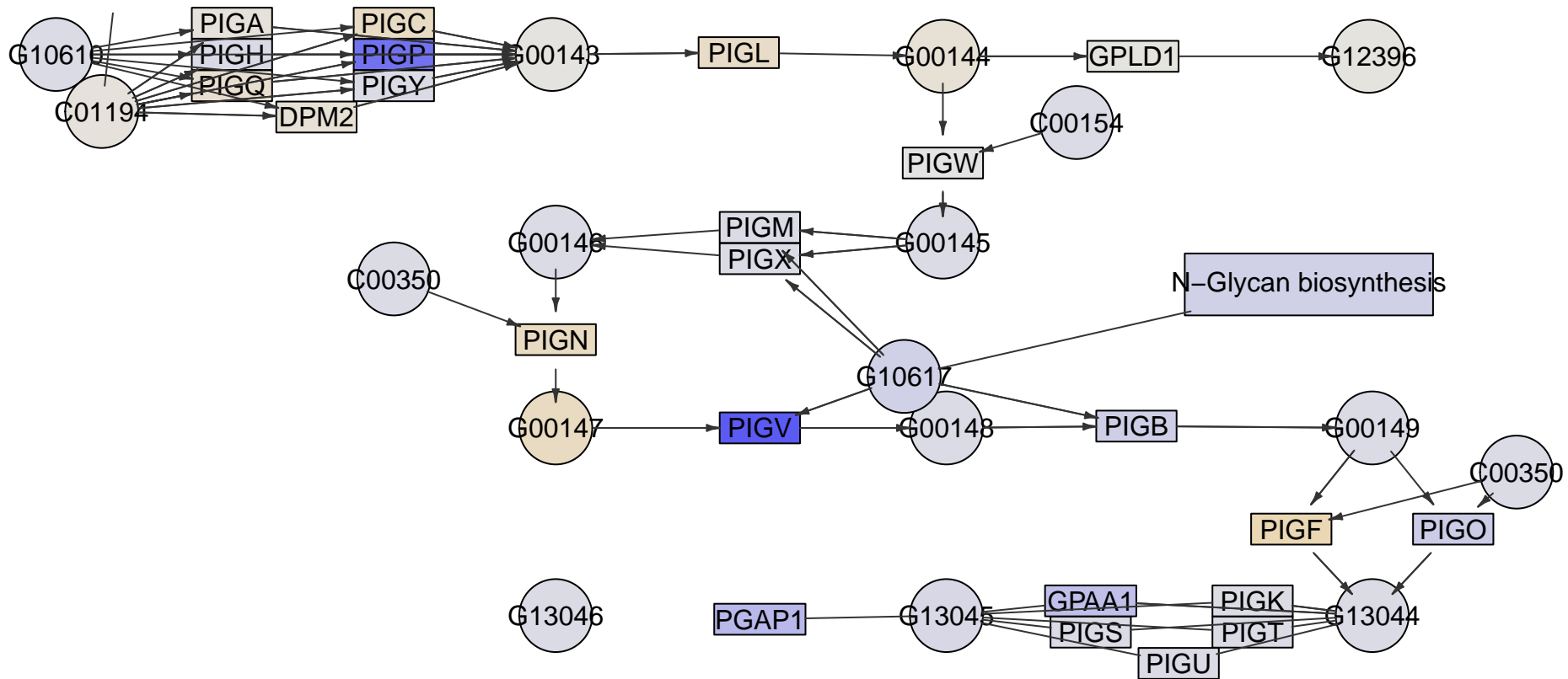

PIGK

PIGO

PIGG

PIGN

PIGZ

PIGB

PIGV

PIGM

PIGA

Glycosylphosphatidylinositol(GPI)-anchor
biosynthesis
MPI-081

Glycerophospholipid
metabolism

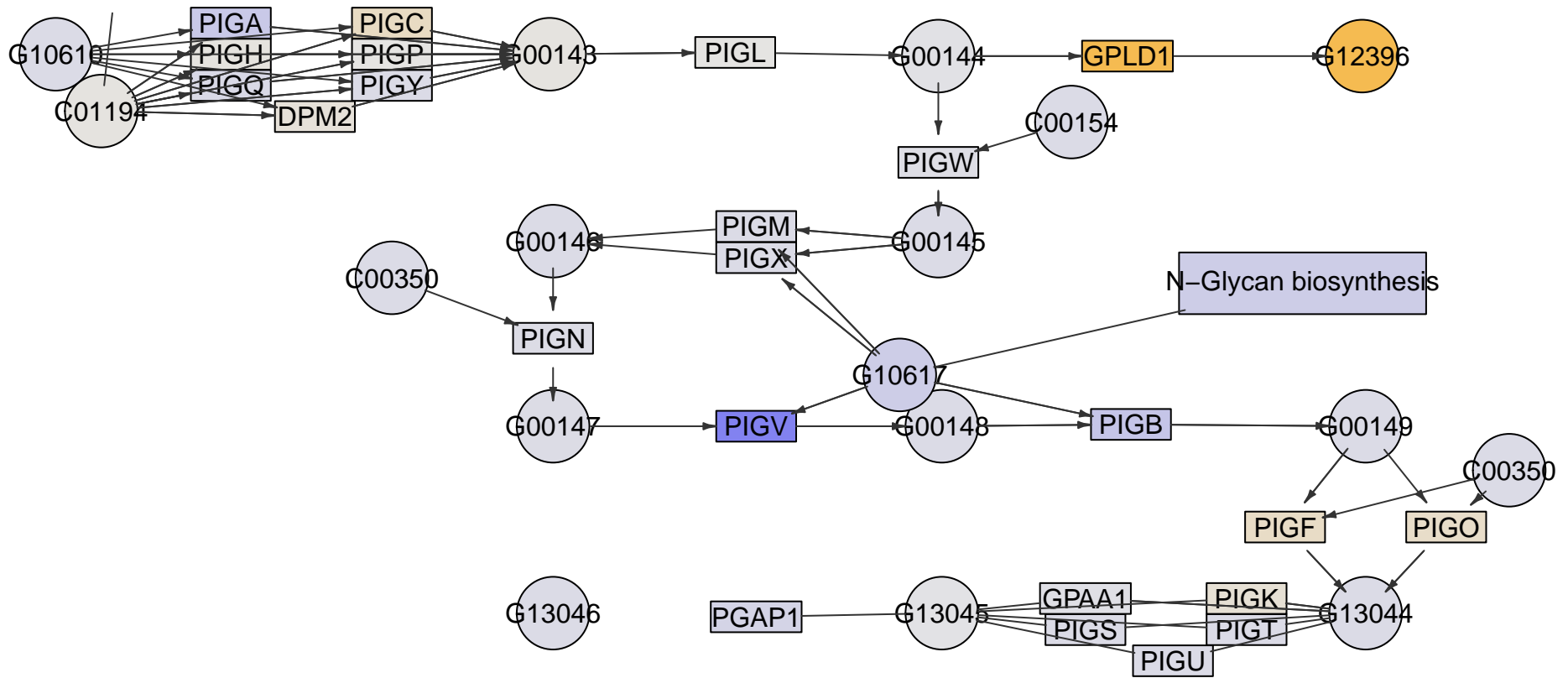

PIGK

PIGO

PIGG

PIGN

PIGZ

PIGB

PIGV

PIGM

PIGA

Glycosylphosphatidylinositol(GPI)-anchor
biosynthesis
MPI-082

Glycerophospholipid
metabolism

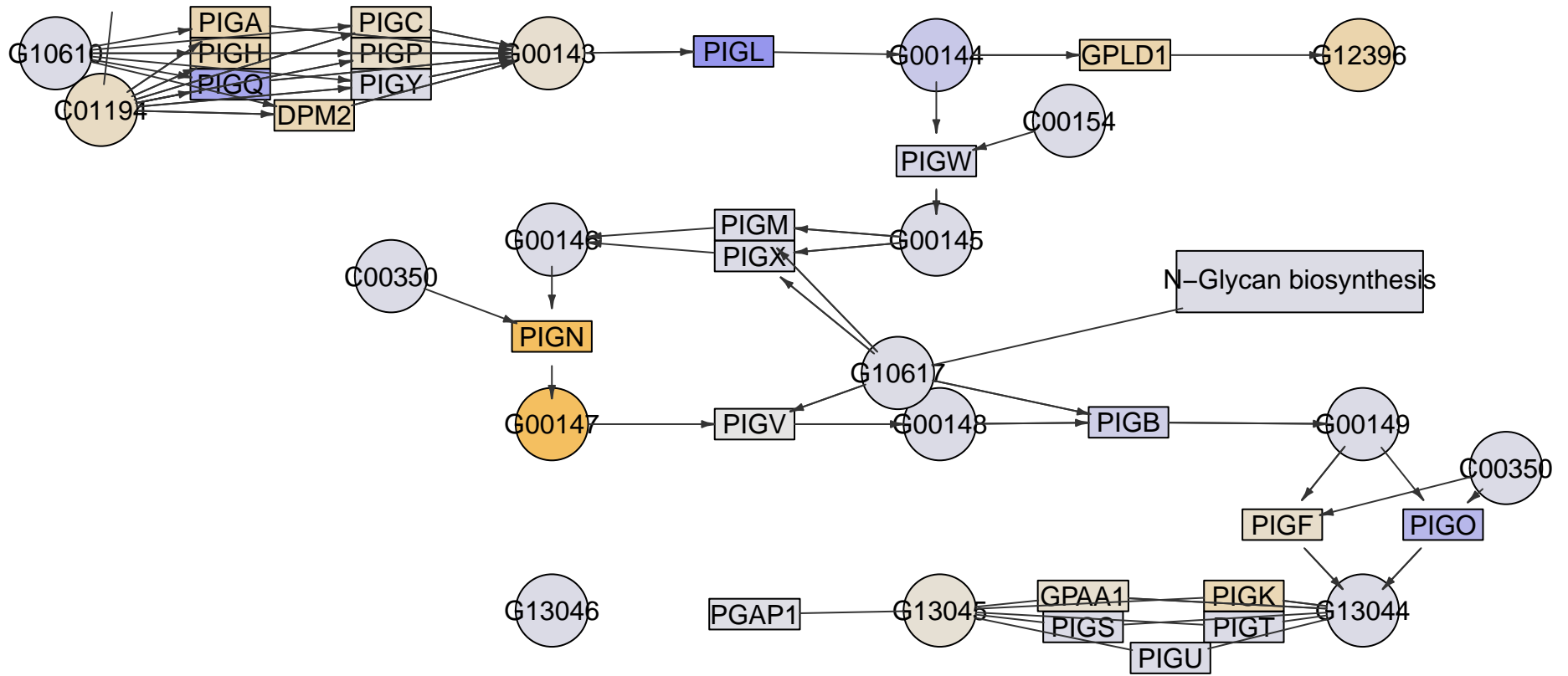

N-Glycan biosynthesis

PIGK

PIGO

PIGG

PIGN

PIGZ

PIGB

PIGV

PIGM

PIGA

Glycosylphosphatidylinositol(GPI)-anchor
biosynthesis
MPI-084

Glycerophospholipid
metabolism

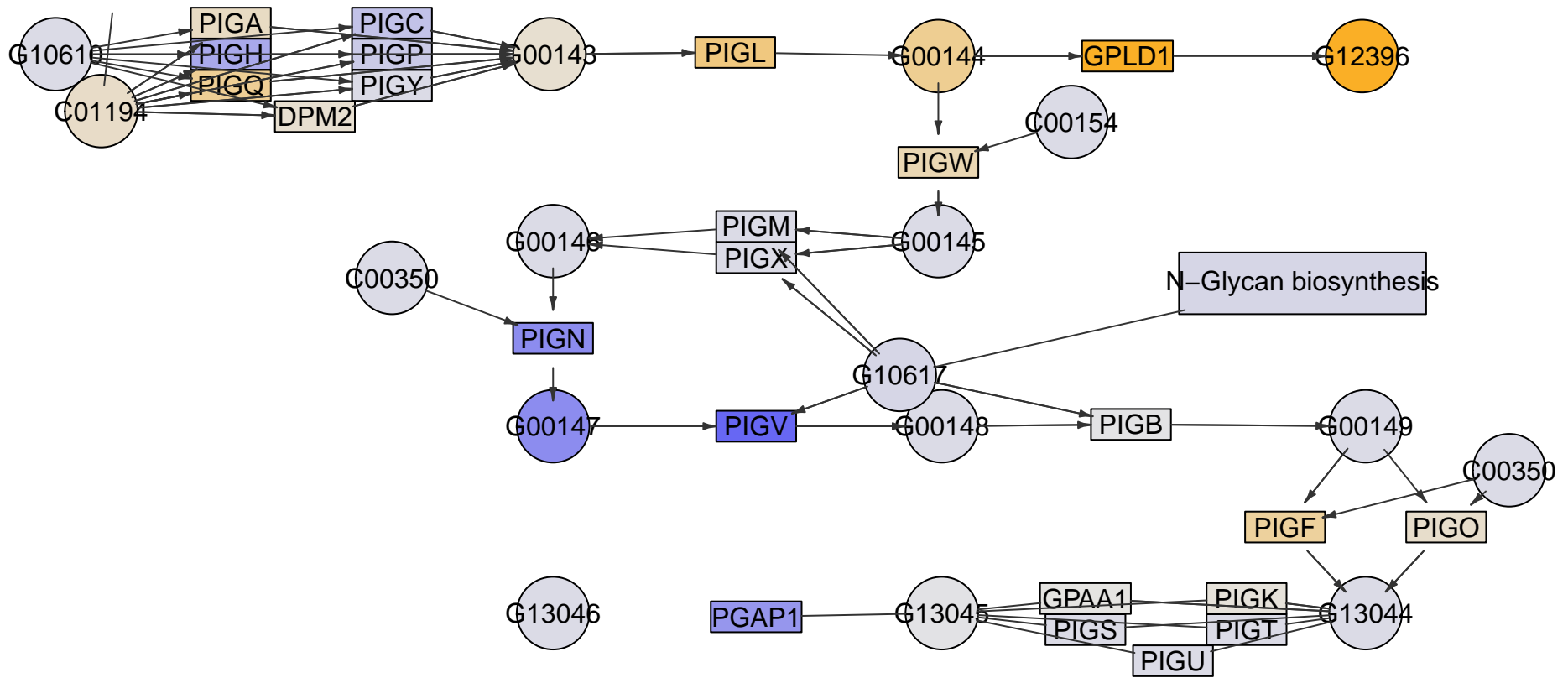

PIGK

PIGO

PIGG

PIGN

PIGZ

PIGB

PIGV

PIGM

PIGA

Glycosylphosphatidylinositol(GPI)-anchor
biosynthesis
MPI-085

Glycerophospholipid
metabolism

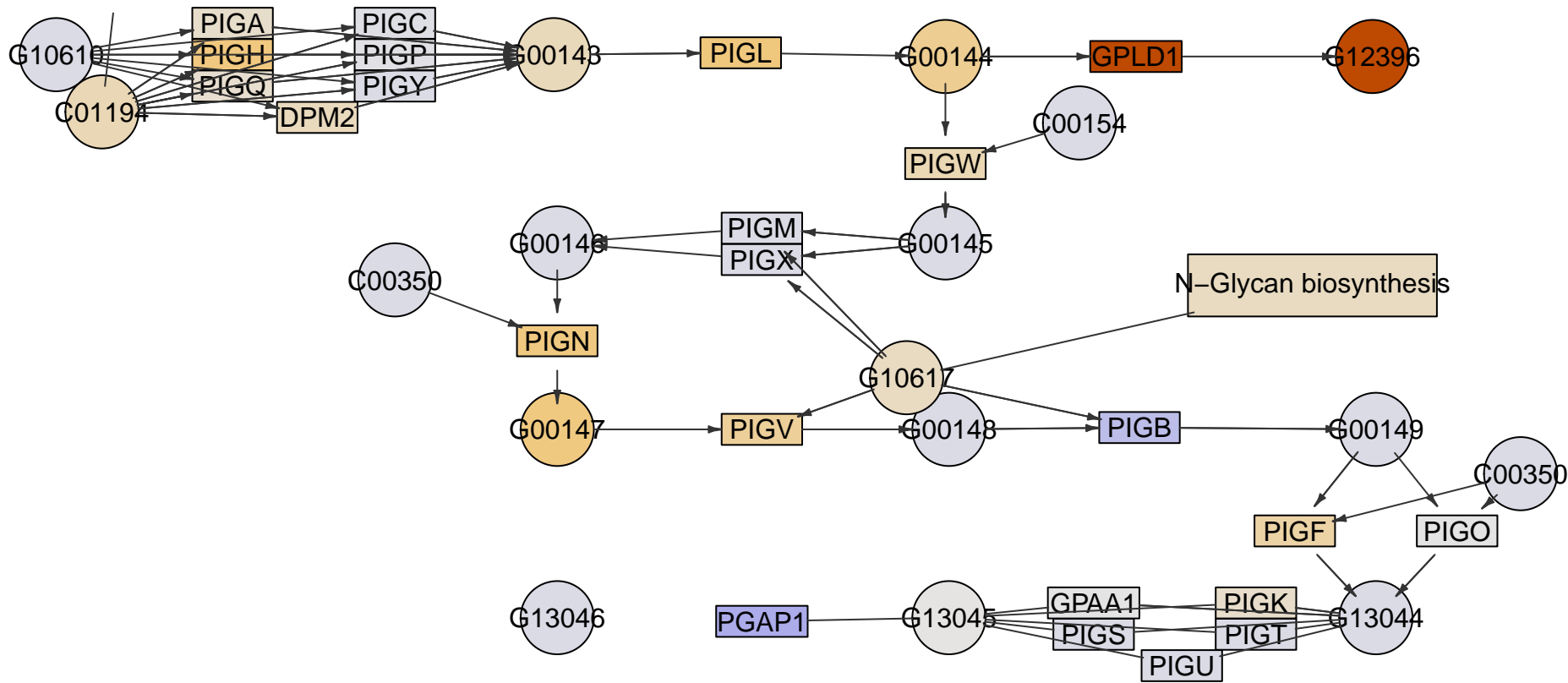

N-Glycan biosynthesis

PIGK

PIGO

PIGG

PIGN

PIGZ

PIGB

PIGV

PIGM

PIGA

Glycosylphosphatidylinositol(GPI)-anchor
biosynthesis
MPI-087

Glycerophospholipid
metabolism

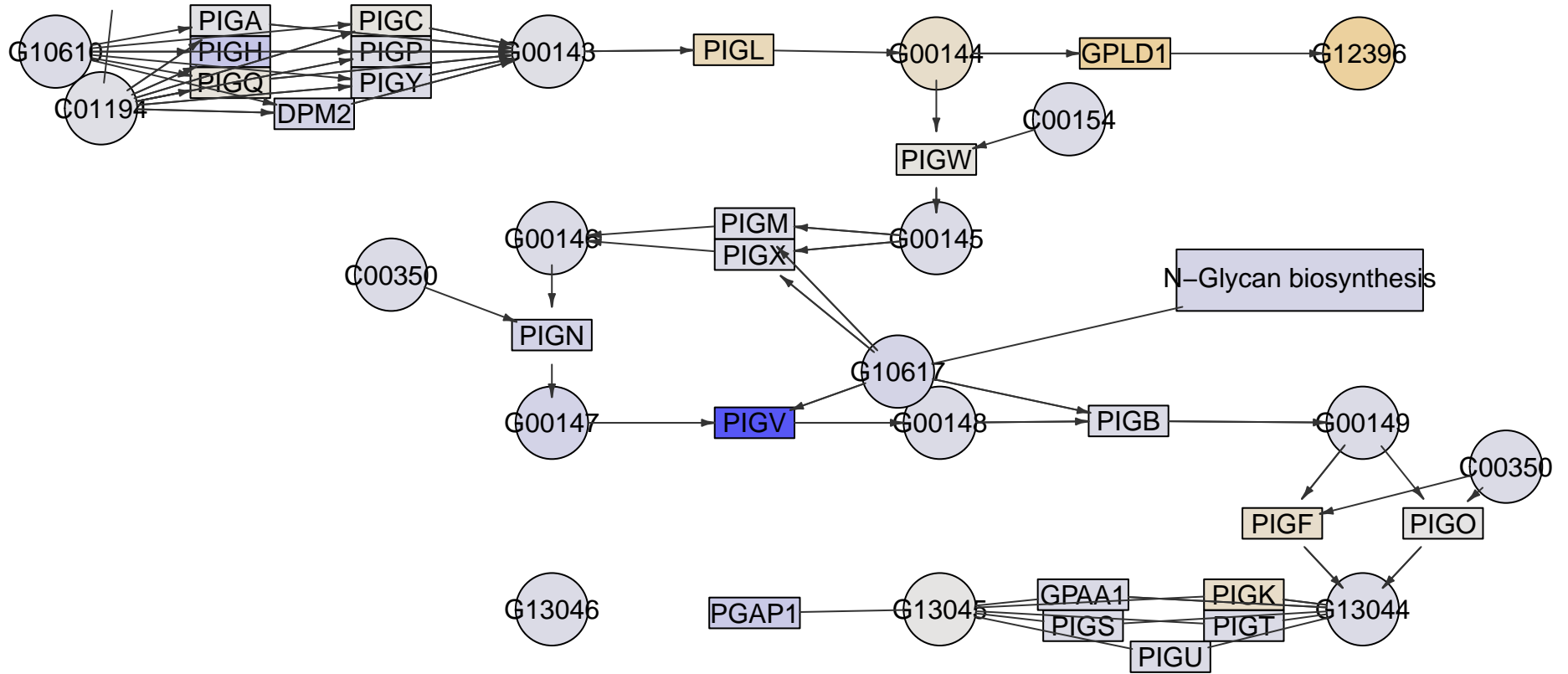

N-Glycan biosynthesis

PIGK

PIGO

PIGG

PIGN

PIGZ

PIGB

PIGV

PIGM

PIGA

Glycosylphosphatidylinositol(GPI)-anchor
biosynthesis
MPI-089

Glycerophospholipid
metabolism

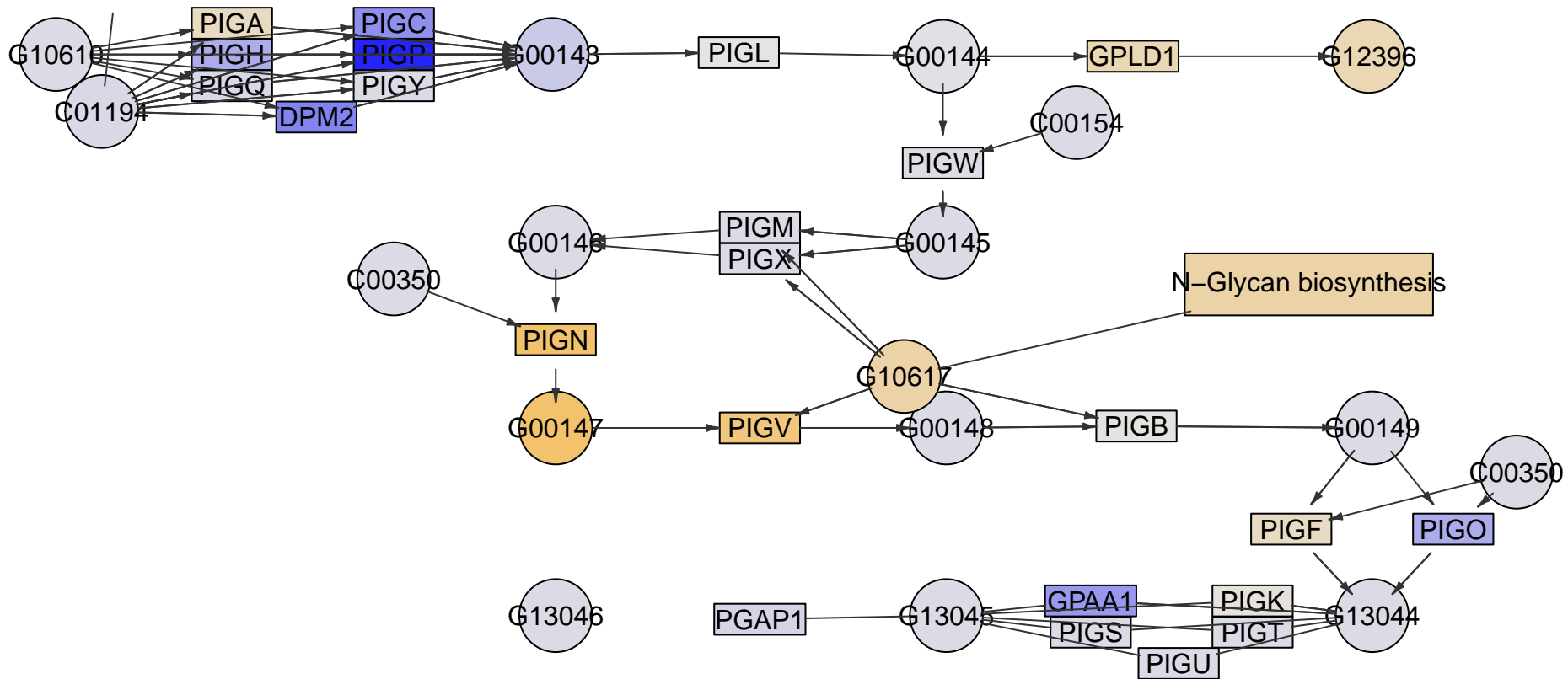

N-Glycan biosynthesis

PIGK

PIGO

PIGG

PIGN

PIGZ

PIGB

PIGV

PIGM

PIGA

Glycosylphosphatidylinositol(GPI)-anchor
biosynthesis
MPI-090

Glycerophospholipid
metabolism

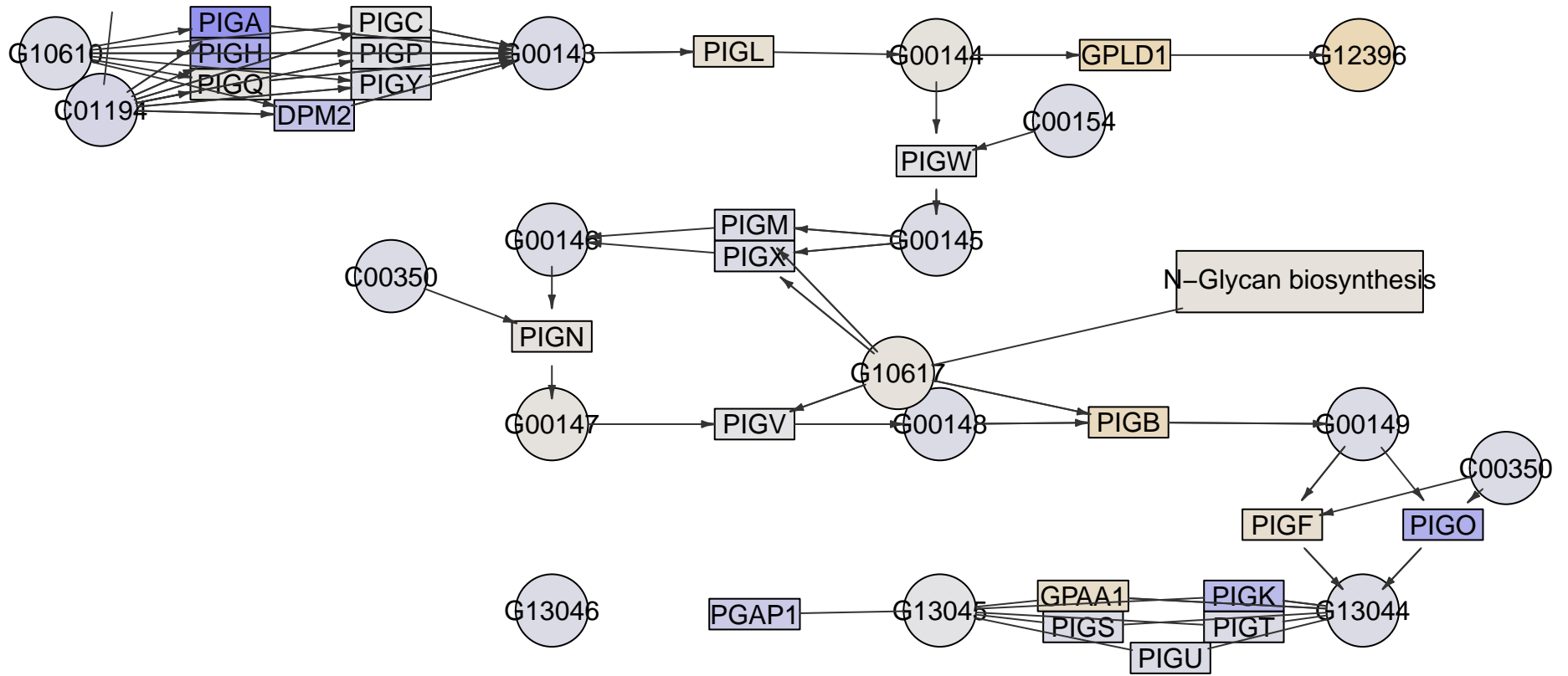

PIGK

PIGO

PIGG

PIGN

PIGZ

PIGB

PIGV

PIGM

PIGA

Glycosylphosphatidylinositol(GPI)-anchor
biosynthesis
MPI-091

Glycerophospholipid
metabolism

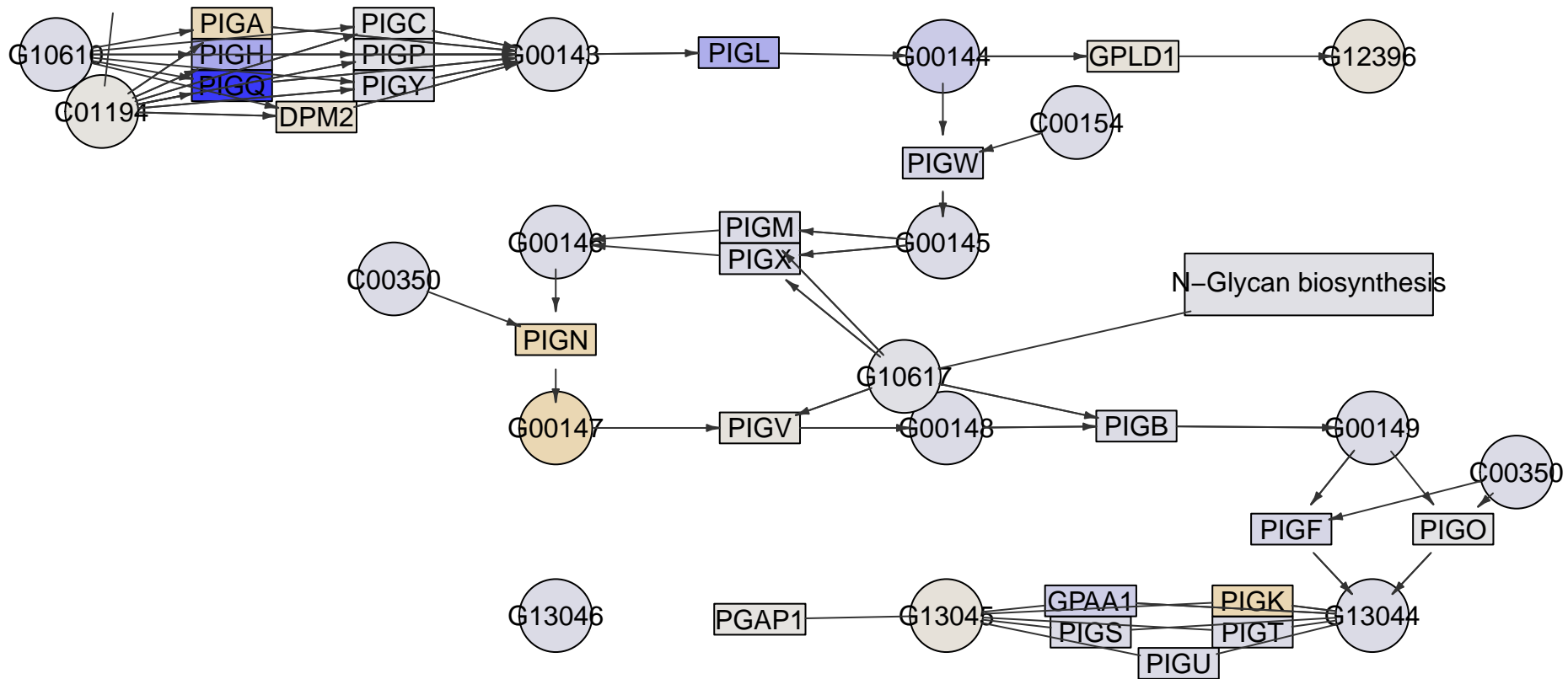

PIGK

PIGO

PIGG

PIGN

PIGZ

PIGB

PIGV

PIGM

PIGA

Glycosylphosphatidylinositol(GPI)-anchor
biosynthesis
MPI-095

Glycerophospholipid
metabolism

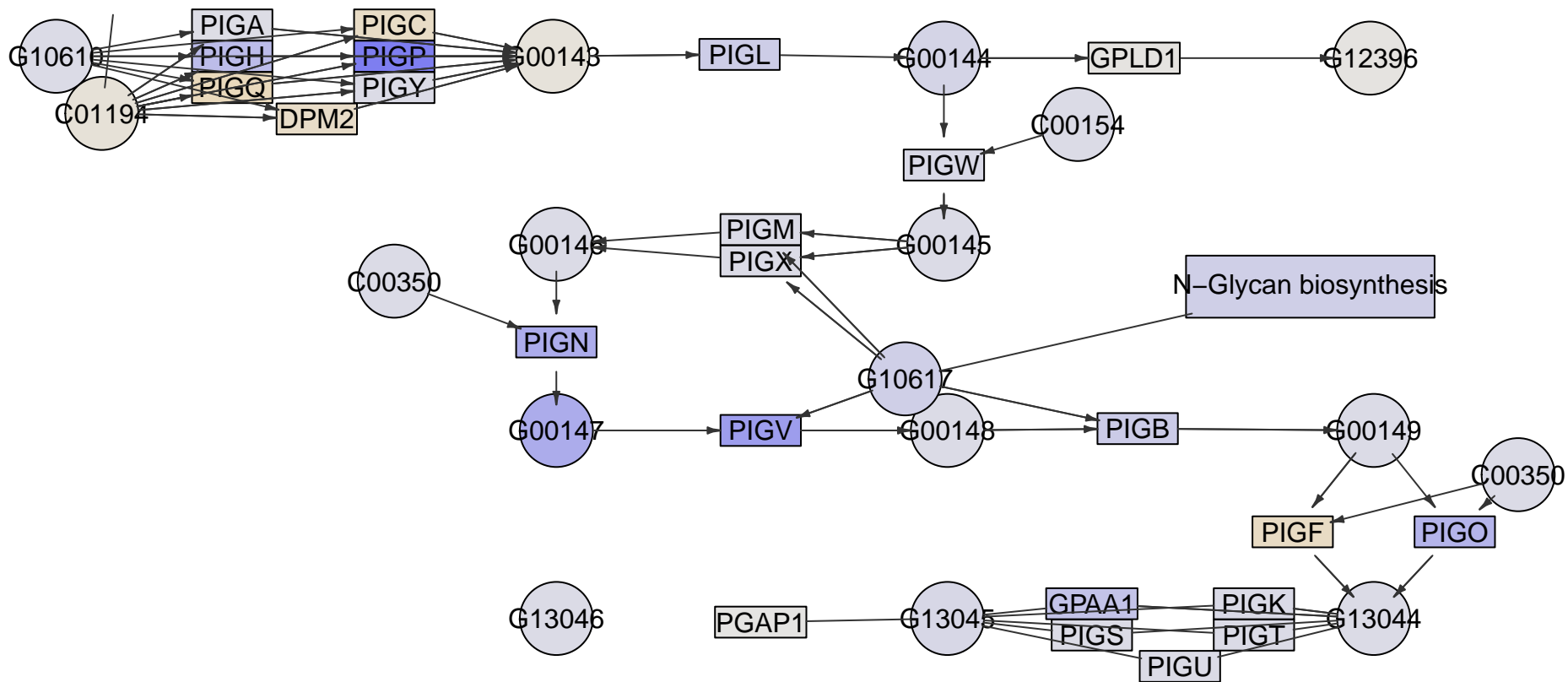

PIGK

PIGO

PIGG

PIGN

PIGZ

PIGB

PIGV

PIGM

PIGA

Glycosylphosphatidylinositol(GPI)-anchor
biosynthesis
MPI-101

Glycerophospholipid
metabolism

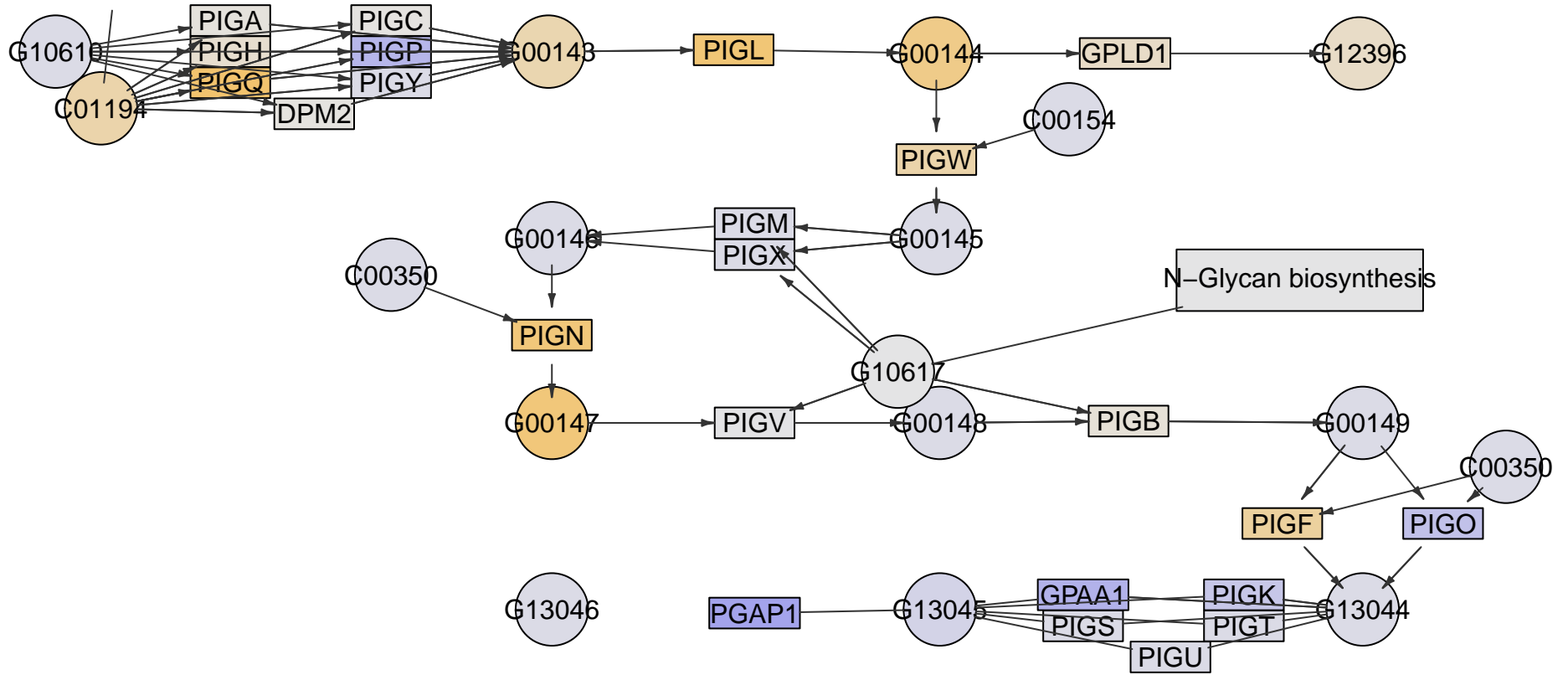

PIGK

PIGO

PIGG

PIGN

PIGZ

PIGB

PIGV

PIGM

PIGA

Glycosylphosphatidylinositol(GPI)-anchor
biosynthesis
MPI-114

Glycerophospholipid
metabolism

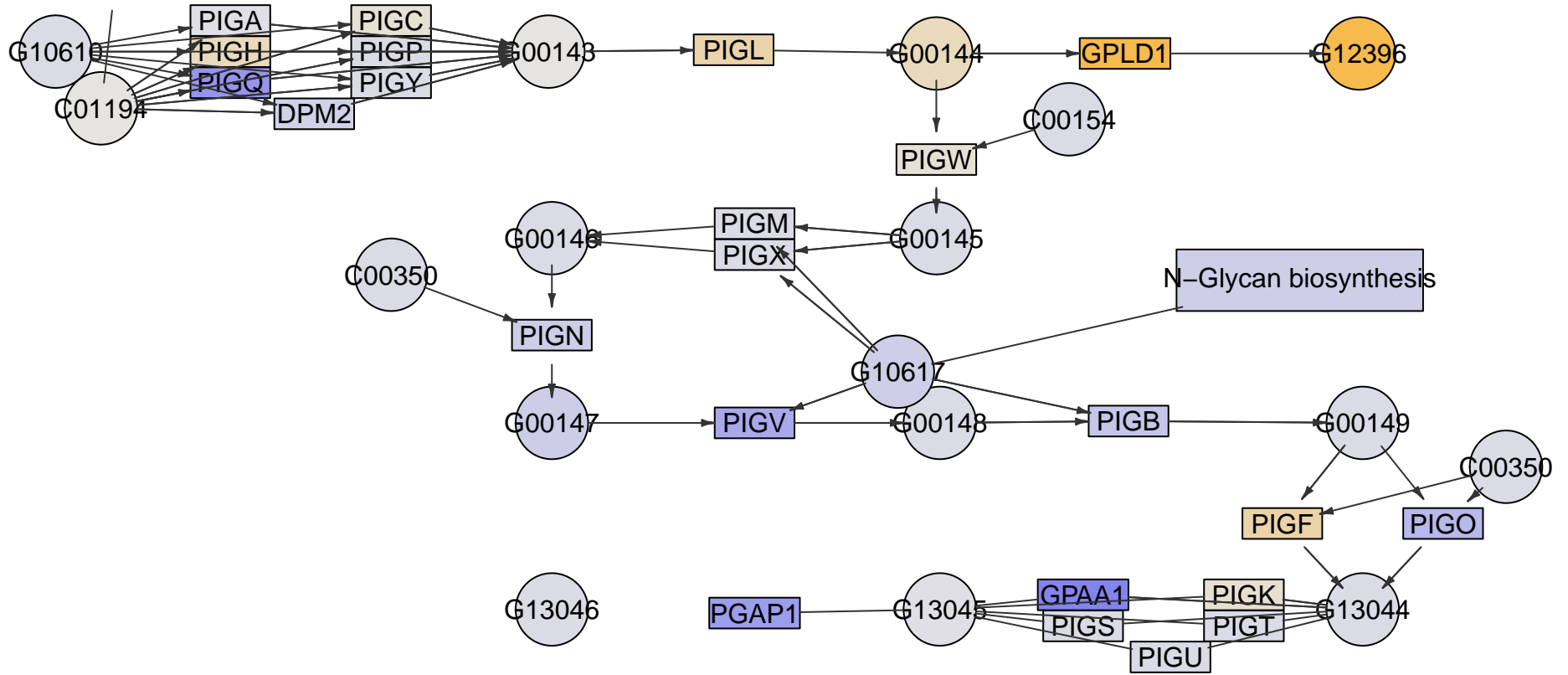

N-Glycan biosynthesis

PIGK

PIGO

PIGG

PIGN

PIGZ

PIGB

PIGV

PIGM

PIGA

Glycosylphosphatidylinositol(GPI)-anchor
biosynthesis
MPI-123

Glycerophospholipid
metabolism

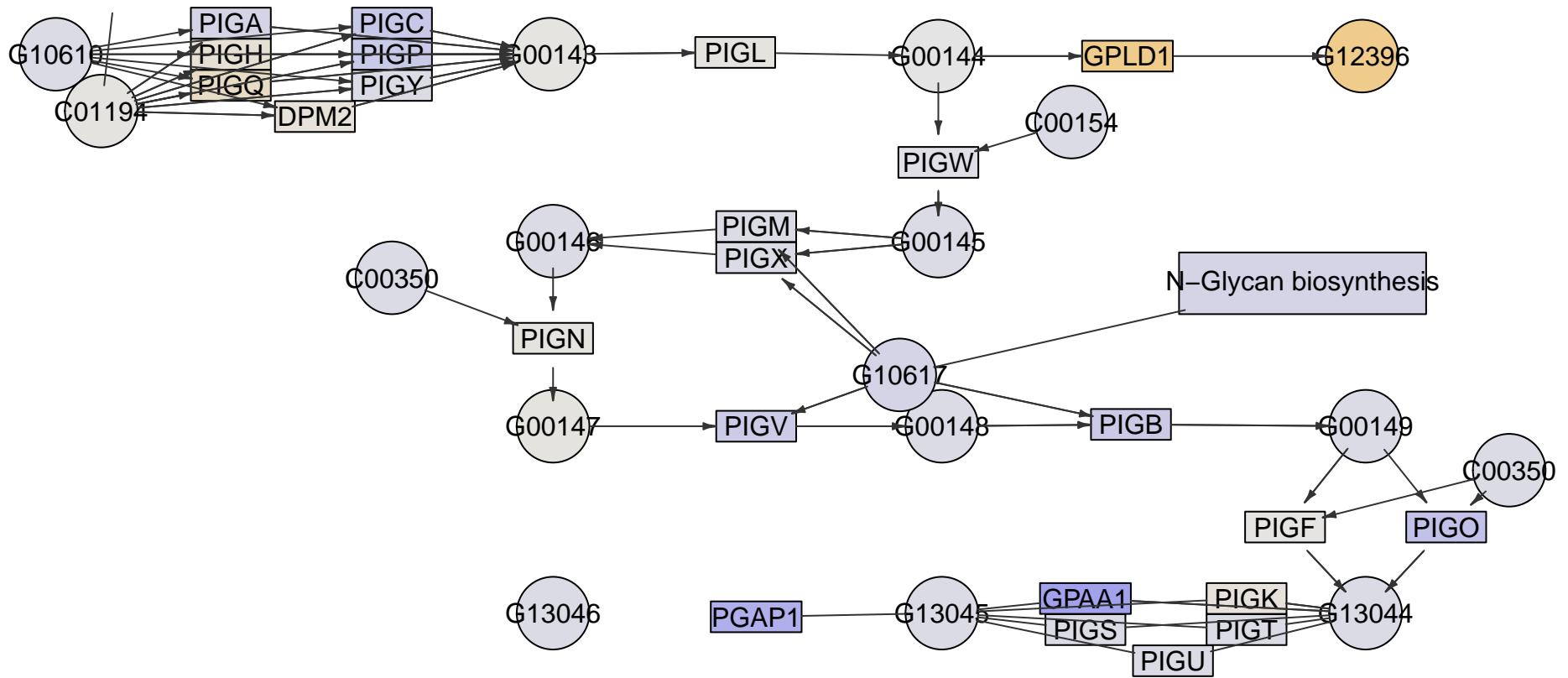

PIGK

PIGO

PIGG

PIGN

PIGZ

PIGB

PIGV

PIGM

PIGA

Glycosylphosphatidylinositol(GPI)-anchor
biosynthesis
MPI-138

Glycerophospholipid
metabolism

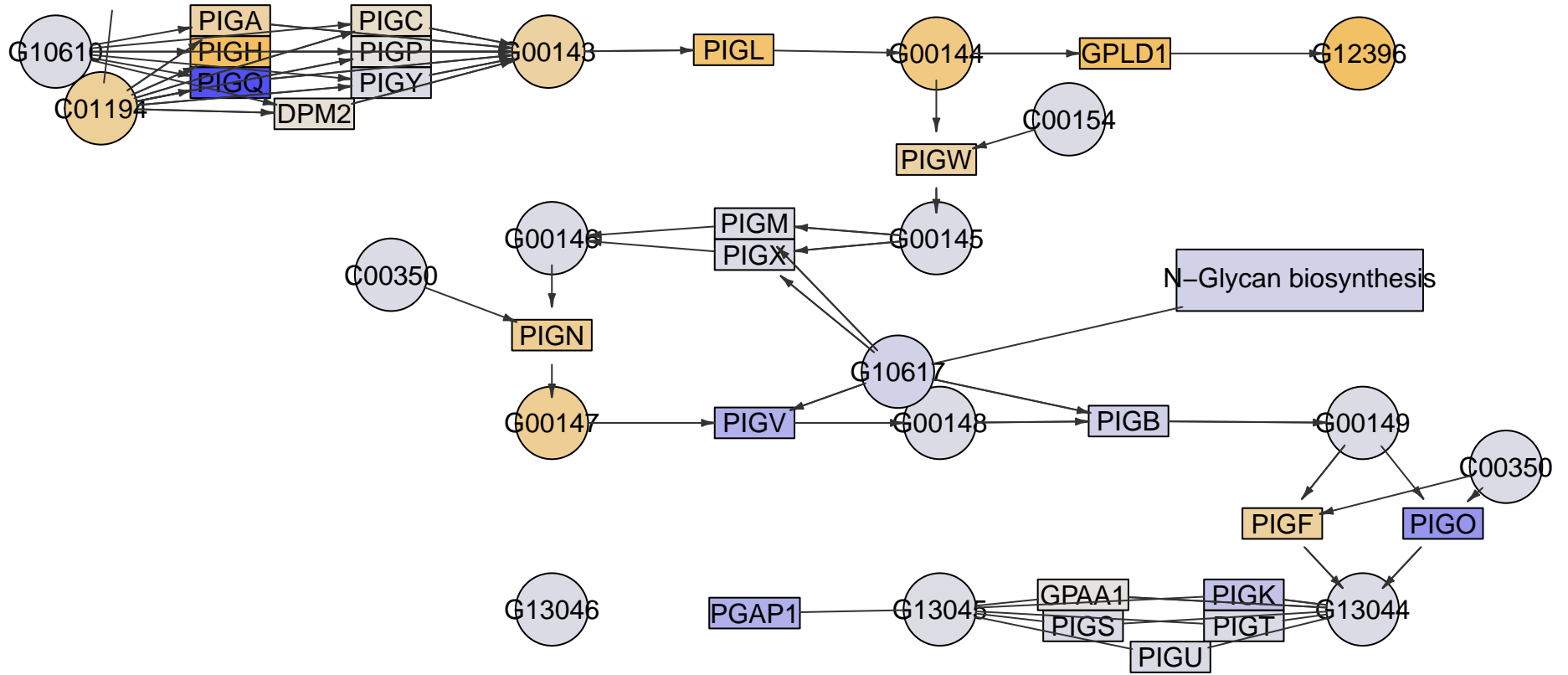

PIGK

PIGO

PIGG

PIGN

PIGZ

PIGB

PIGV

PIGM

PIGA

Glycosylphosphatidylinositol(GPI)-anchor
biosynthesis
MPI-139

Glycerophospholipid
metabolism

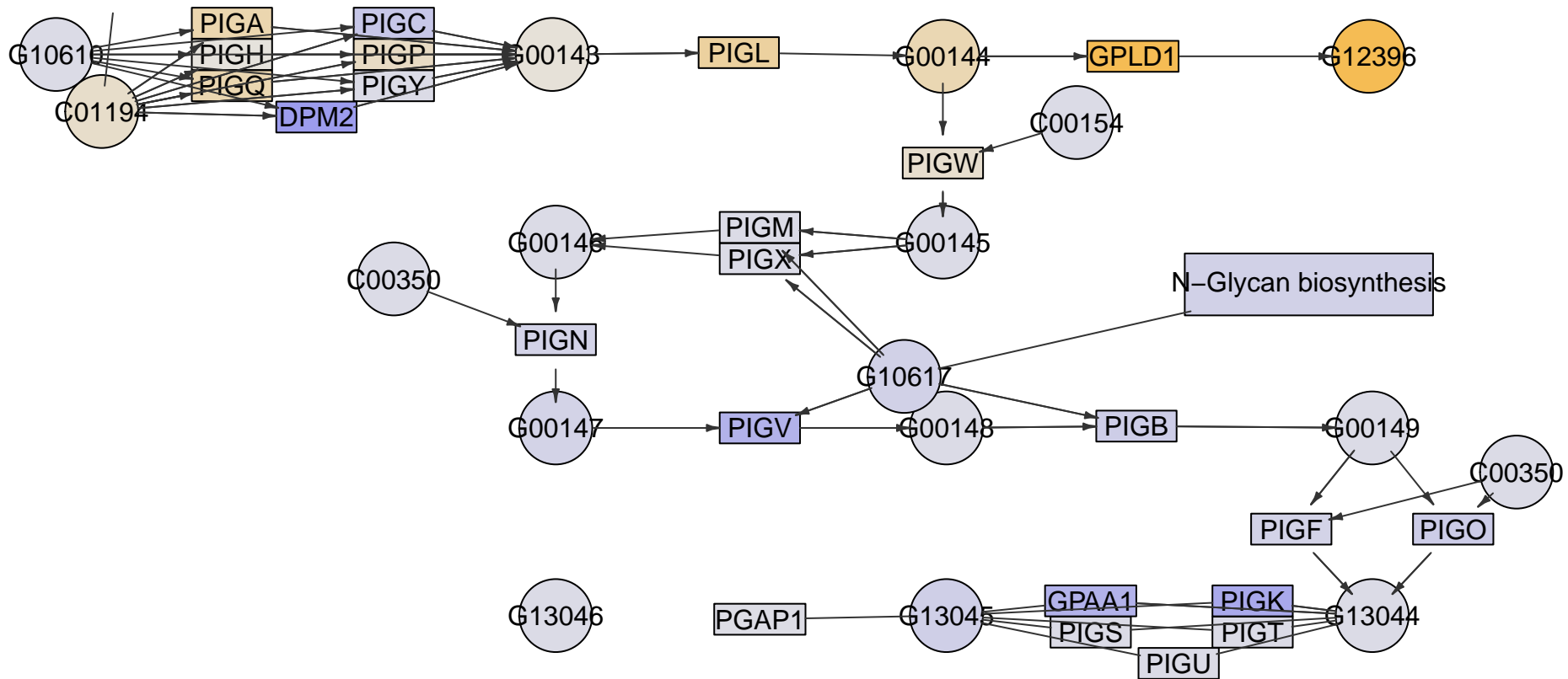

PIGK

PIGO

PIGG

PIGN

PIGZ

PIGB

PIGV

PIGM

PIGA

Glycosylphosphatidylinositol(GPI)-anchor
biosynthesis
MPI-140

Glycerophospholipid
metabolism

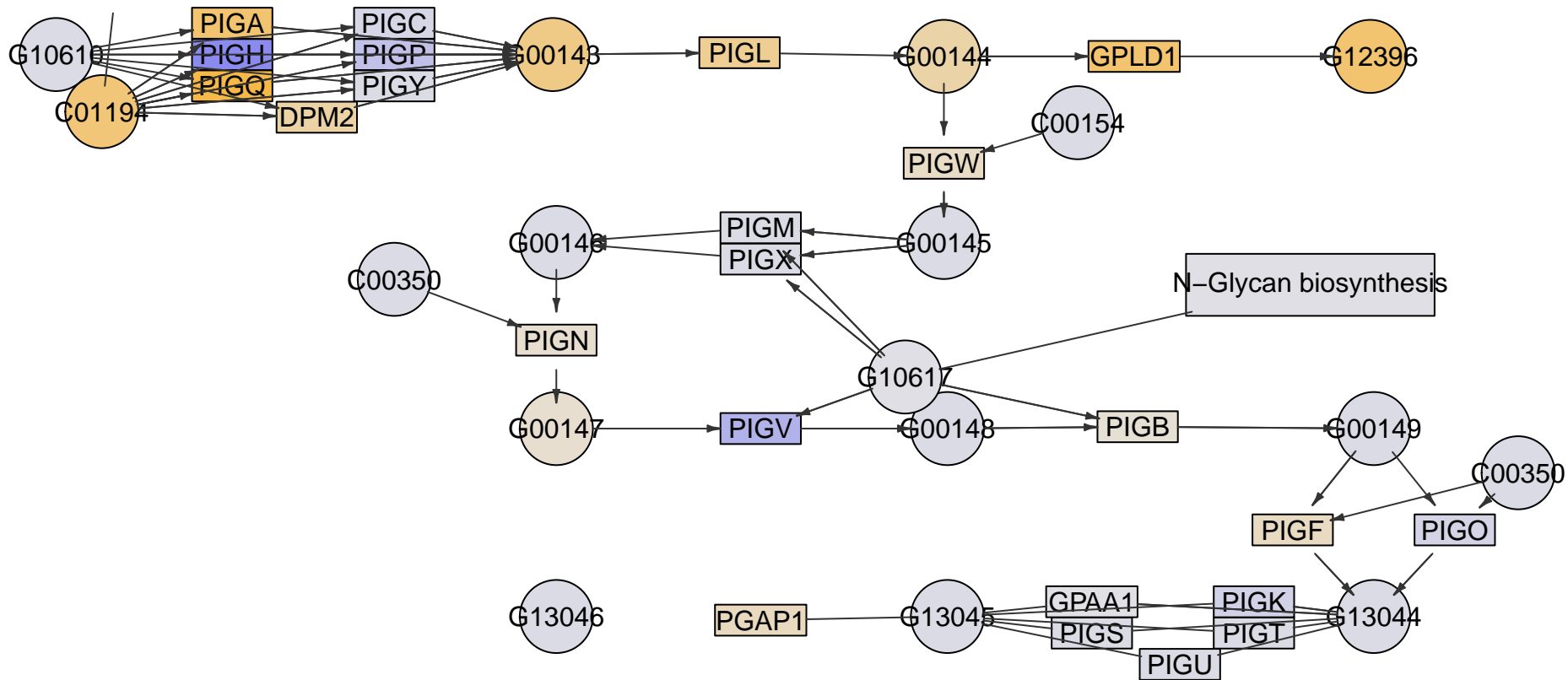

PIGK

PIGO

PIGG

PIGN

PIGZ

PIGB

PIGV

PIGM

PIGA

Glycosylphosphatidylinositol(GPI)-anchor
biosynthesis
MPI-144

Glycerophospholipid
metabolism

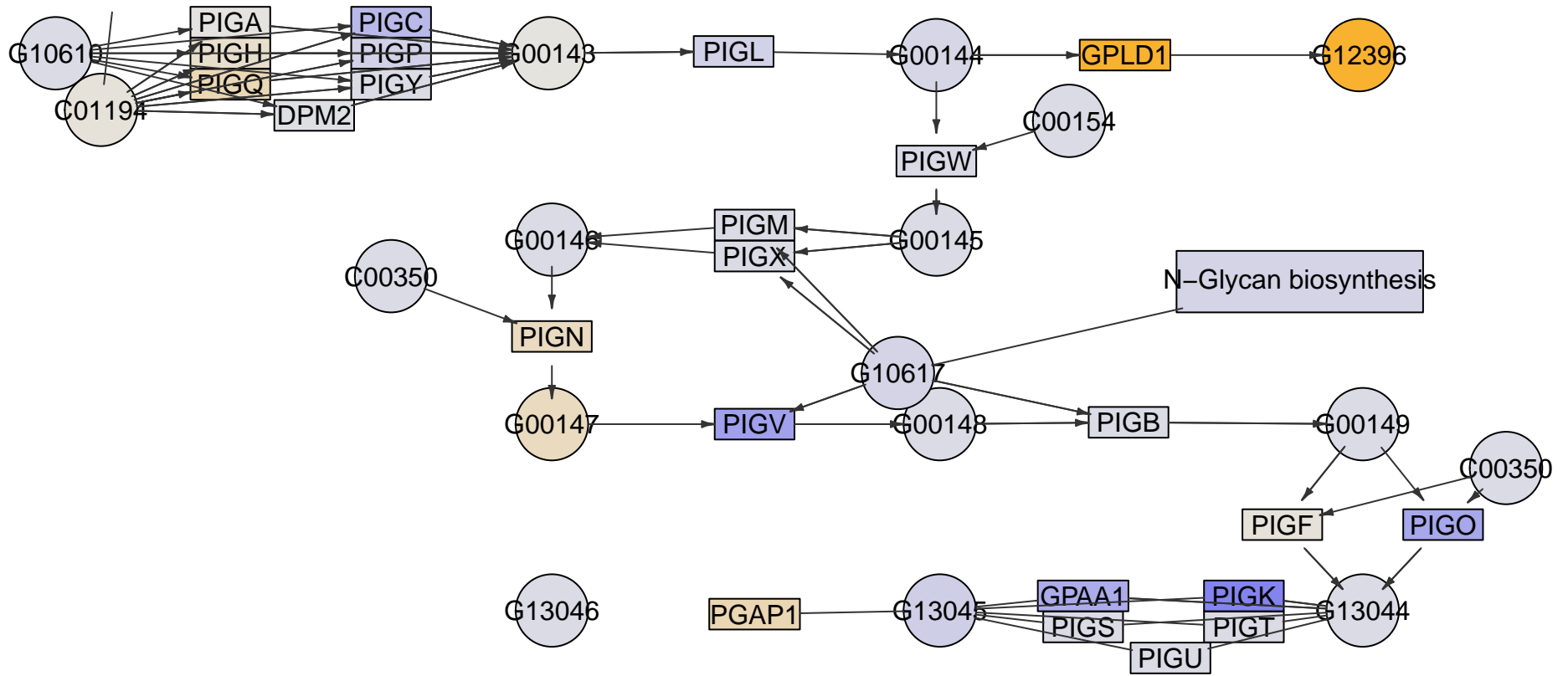

PIGK

PIGO

PIGG

PIGN

PIGZ

PIGB

PIGV

PIGM

PIGA

Glycosylphosphatidylinositol(GPI)-anchor
biosynthesis
MPI-147

Glycerophospholipid
metabolism

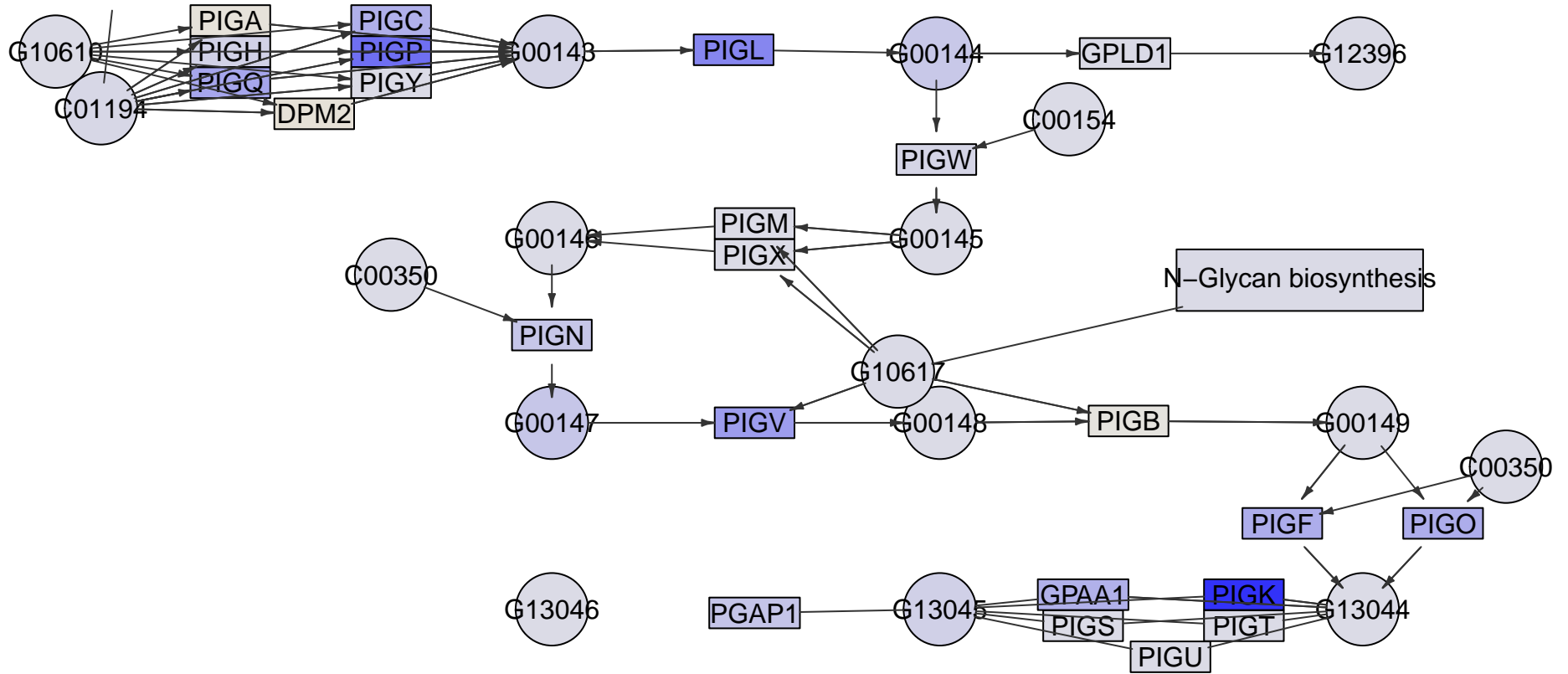

N-Glycan biosynthesis

PIGK

PIGO

PIGG

PIGN

PIGZ

PIGB

PIGV

PIGM

PIGA

Glycosylphosphatidylinositol(GPI)-anchor
biosynthesis
MPI-171

Glycerophospholipid
metabolism

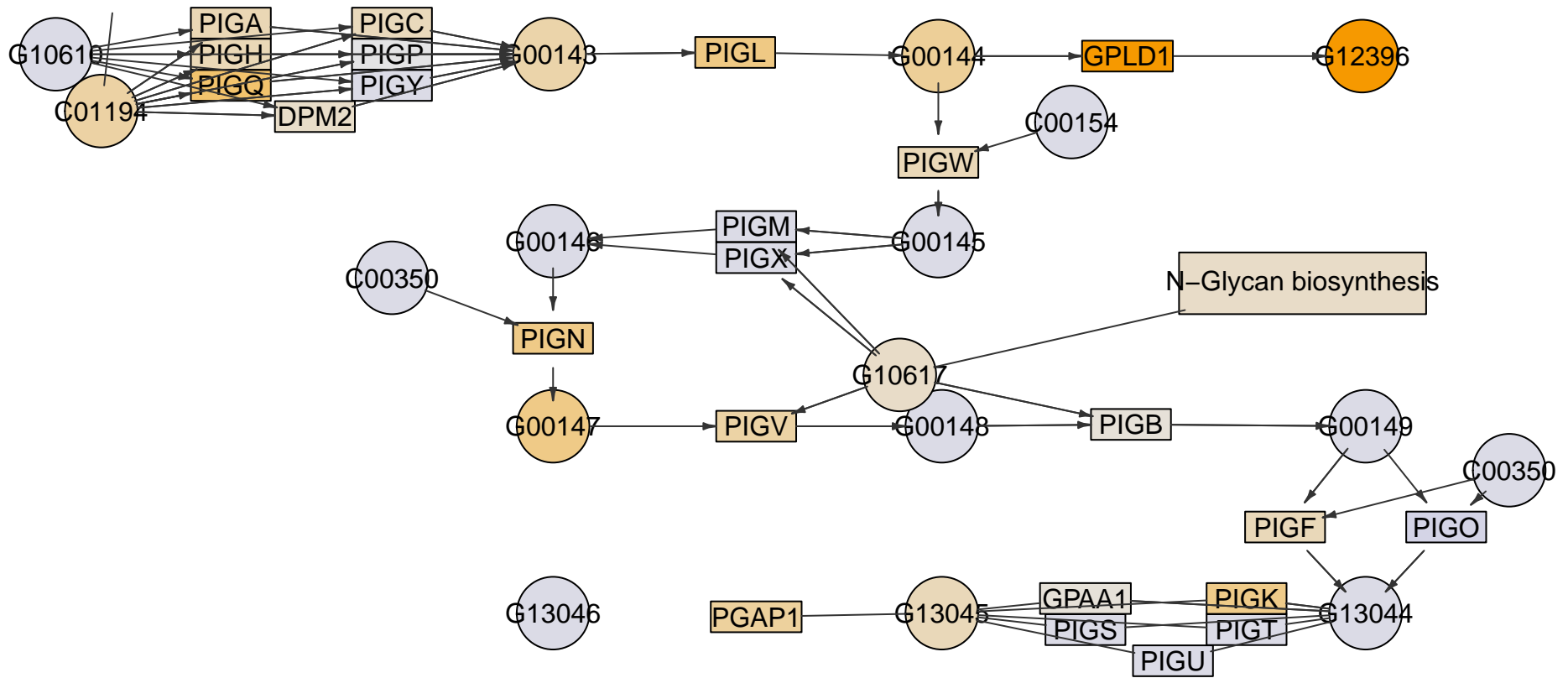

PIGK

PIGO

PIGG

PIGN

PIGZ

PIGB

PIGV

PIGM

PIGA

Glycosylphosphatidylinositol(GPI)-anchor
biosynthesis
MPI-172

Glycerophospholipid
metabolism

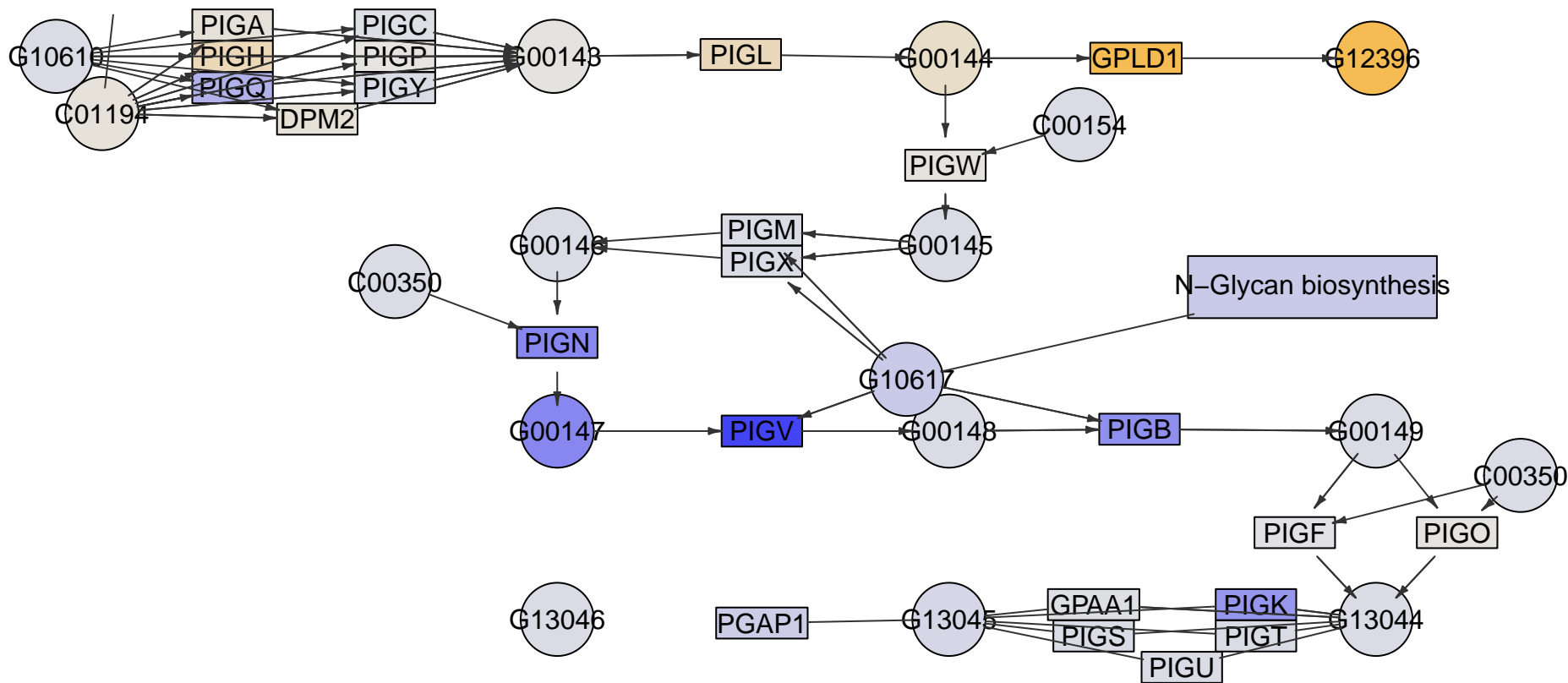

N-Glycan biosynthesis

PIGK

PIGO

PIGG

PIGN

PIGZ

PIGB

PIGV

PIGM

PIGA

Glycosylphosphatidylinositol(GPI)-anchor
biosynthesis
MPI-007

Glycerophospholipid
metabolism

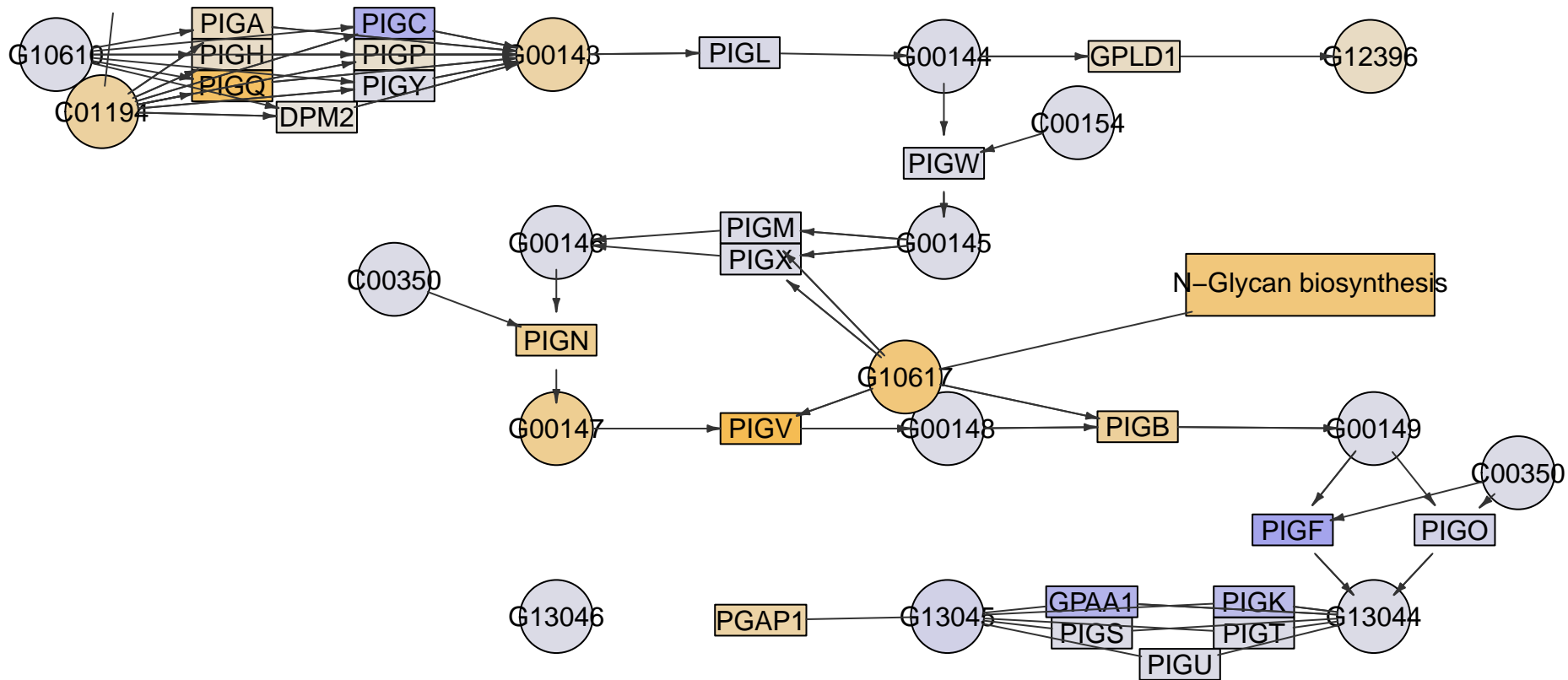

PIGK

PIGO

PIGG

PIGN

PIGZ

PIGB

PIGV

PIGM

PIGA

Glycosylphosphatidylinositol(GPI)-anchor
biosynthesis
MPI-011

Glycerophospholipid
metabolism

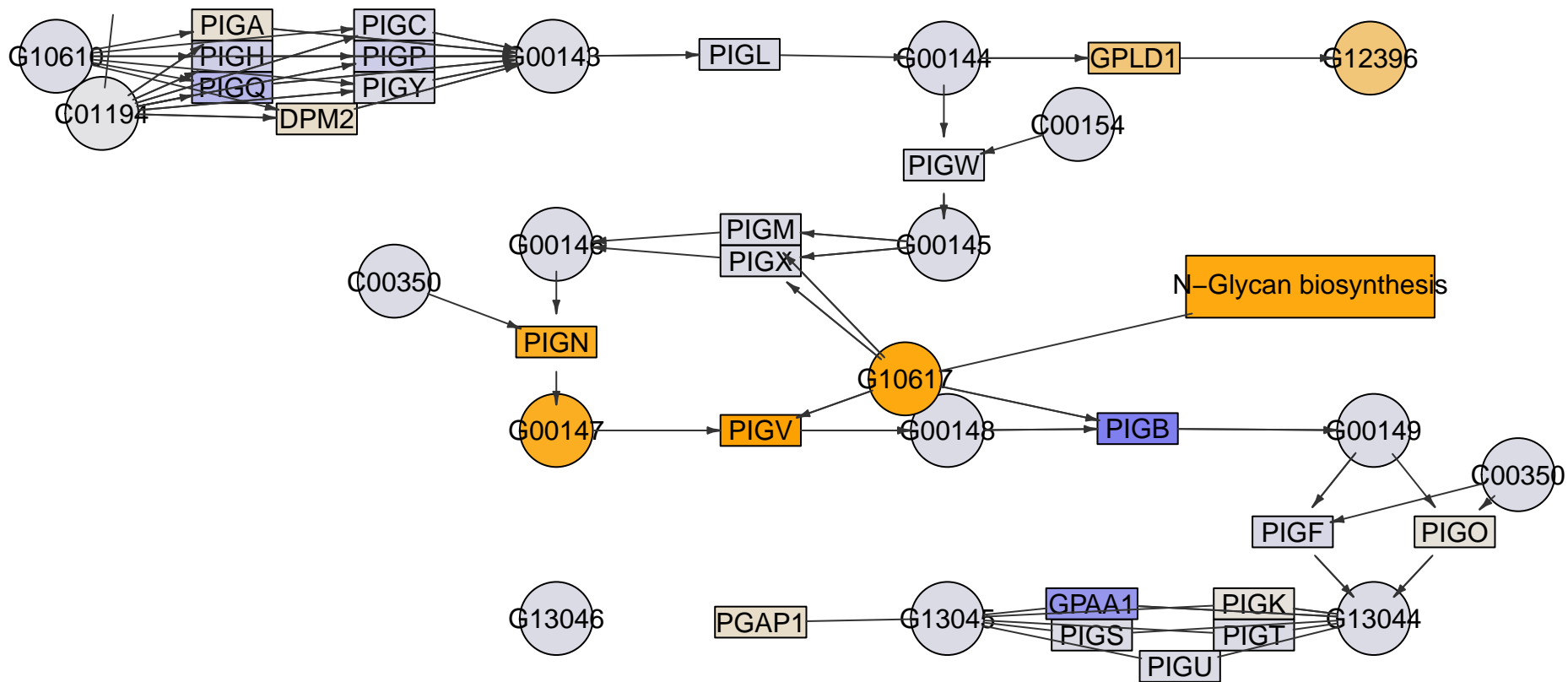

PIGK

PIGO

PIGG

PIGN

PIGZ

PIGB

PIGV

PIGM

PIGA

Glycosylphosphatidylinositol(GPI)-anchor
biosynthesis
MPI-024

Glycerophospholipid
metabolism

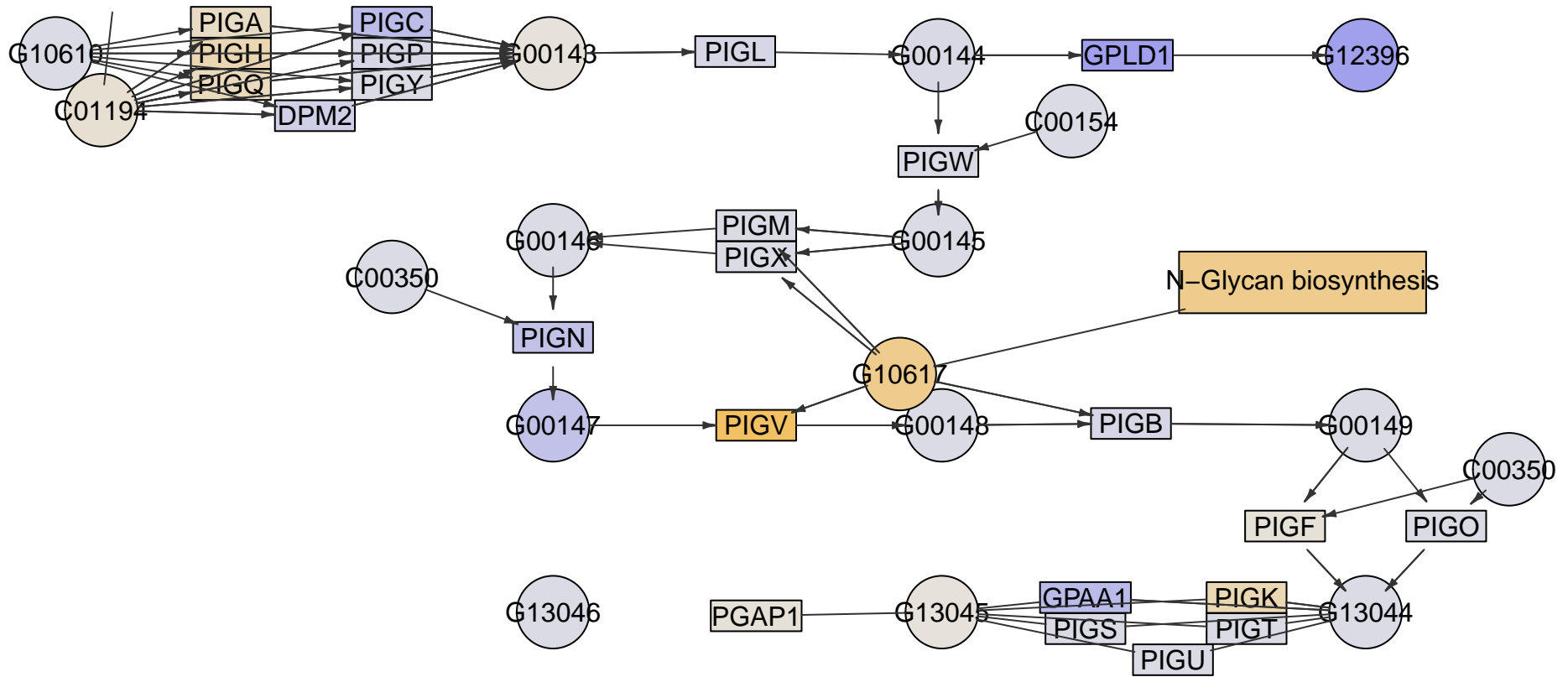

PIGK

PIGO

PIGG

PIGN

PIGZ

PIGB

PIGV

PIGM

PIGA

Glycosylphosphatidylinositol(GPI)-anchor
biosynthesis
MPI-026

Glycerophospholipid
metabolism

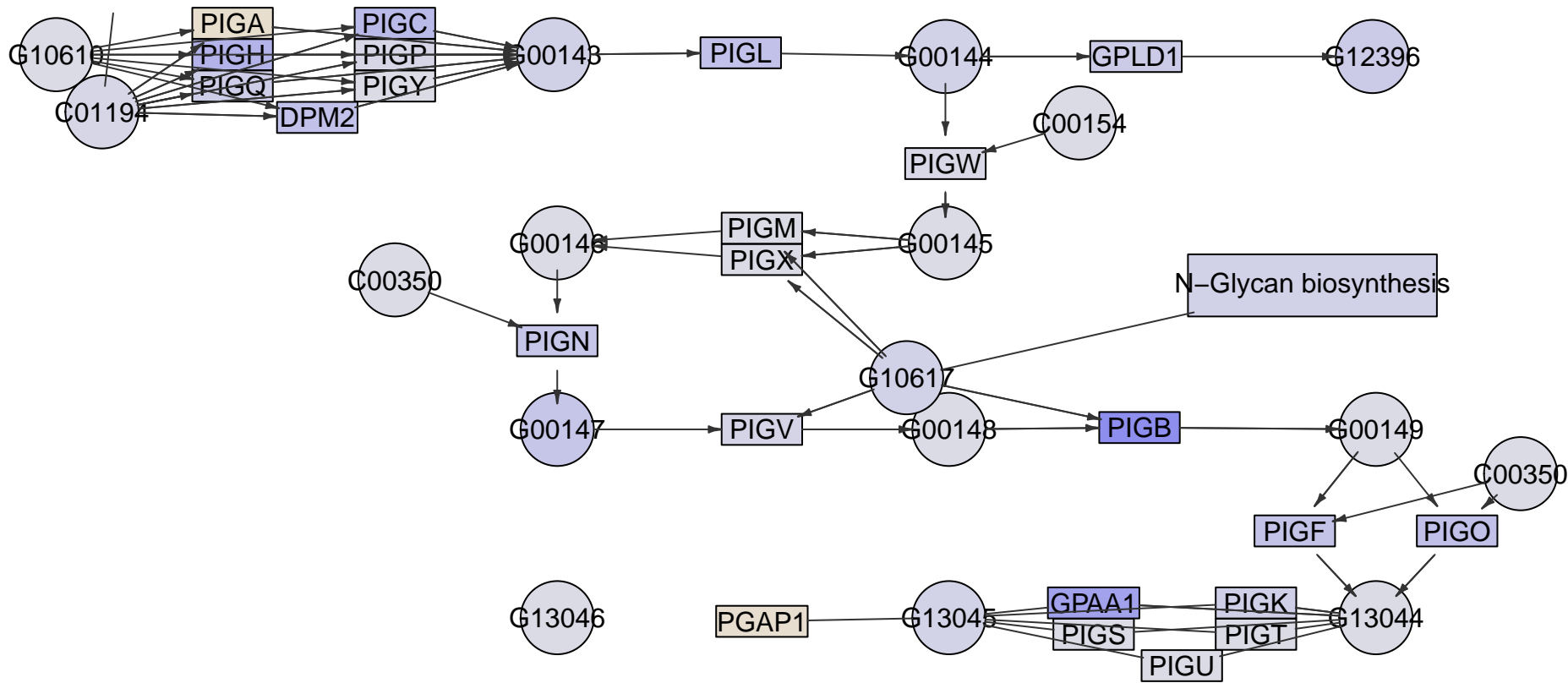

PIGK

PIGO

PIGG

PIGN

PIGZ

PIGB

PIGV

PIGM

PIGA

Glycosylphosphatidylinositol(GPI)-anchor
biosynthesis
MPI-036

Glycerophospholipid
metabolism

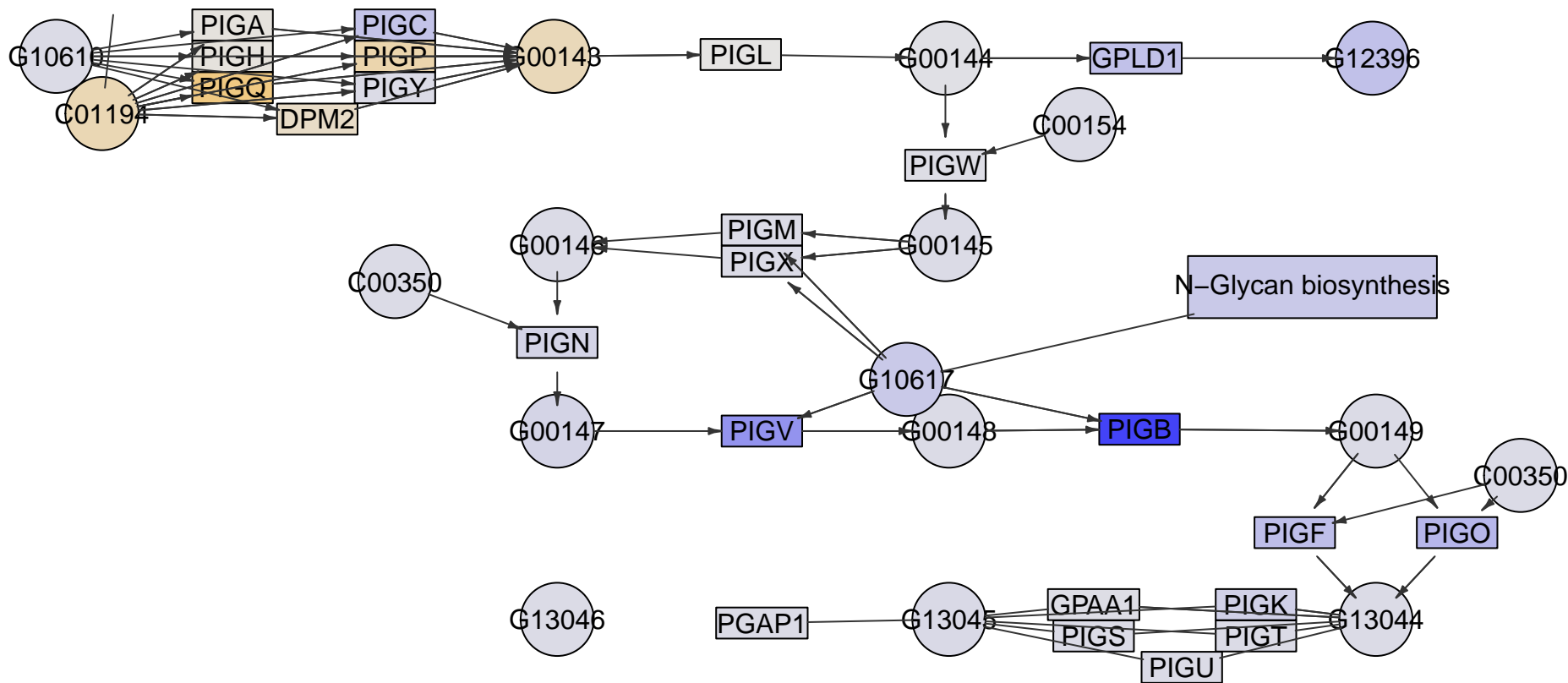

PIGK

PIGO

PIGG

PIGN

PIGZ

PIGB

PIGV

PIGM

PIGA

Glycosylphosphatidylinositol(GPI)-anchor
biosynthesis
MPI-037

Glycerophospholipid
metabolism

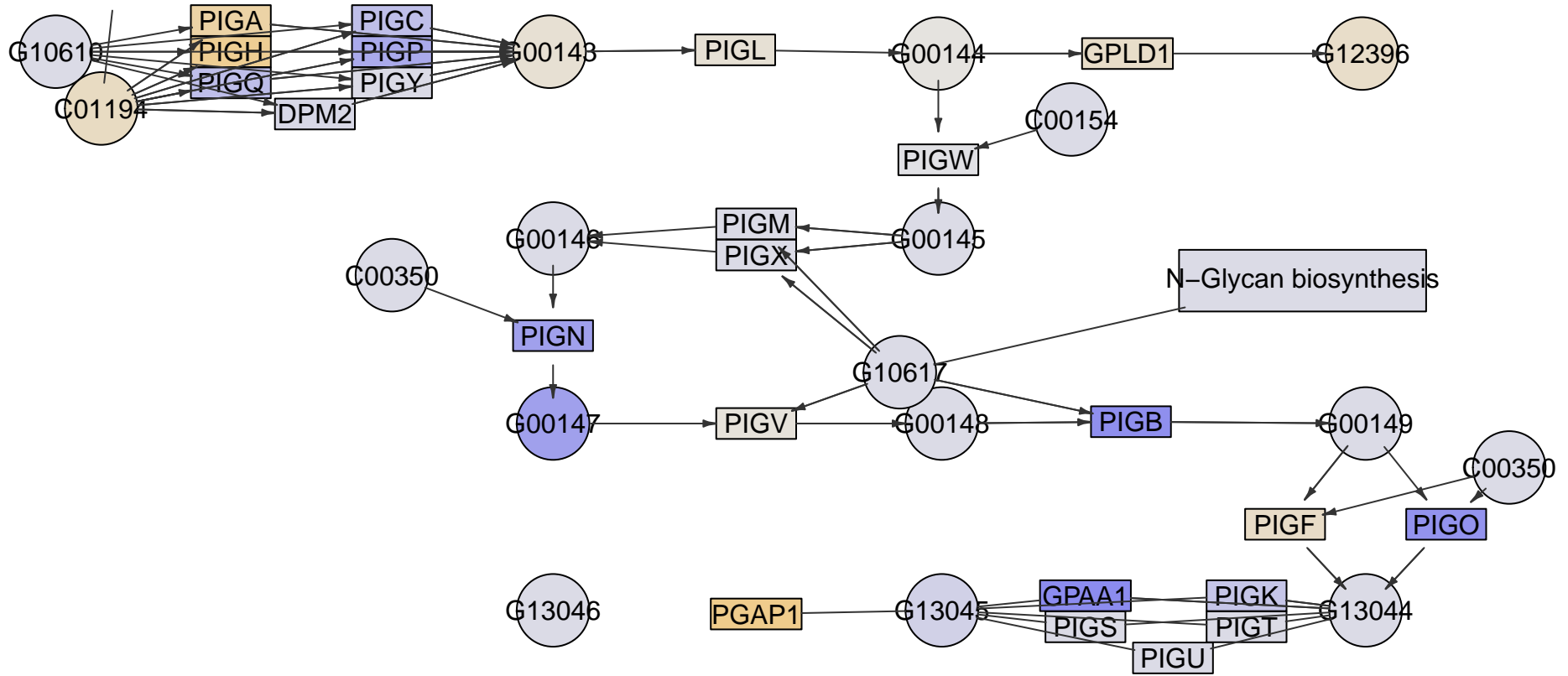

PIGK

PIGO

PIGG

PIGN

PIGZ

PIGB

PIGV

PIGM

PIGA

Glycosylphosphatidylinositol(GPI)-anchor
biosynthesis
MPI-038

Glycerophospholipid
metabolism

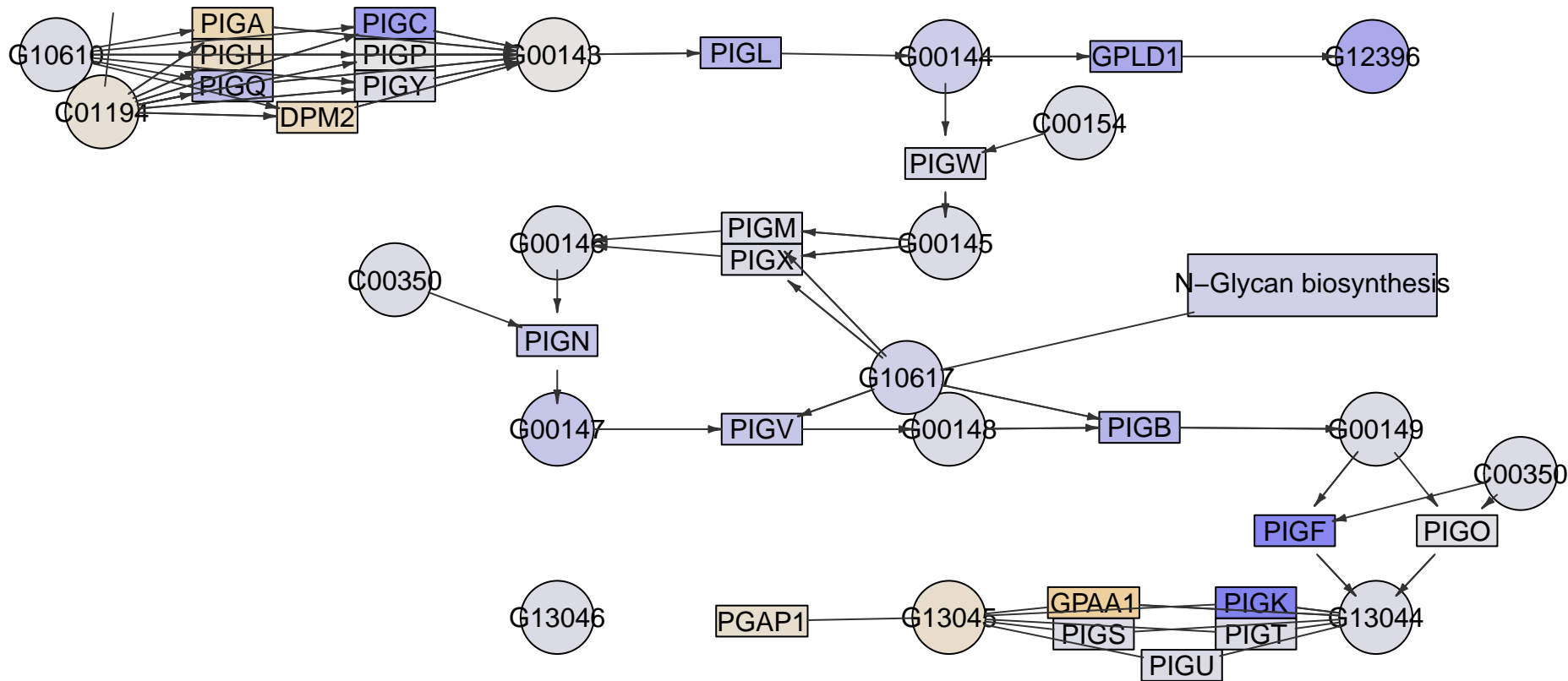

PIGK

PIGO

PIGG

PIGN

PIGZ

PIGB

PIGV

PIGM

PIGA

Glycosylphosphatidylinositol(GPI)-anchor
biosynthesis
MPI-041

Glycerophospholipid
metabolism

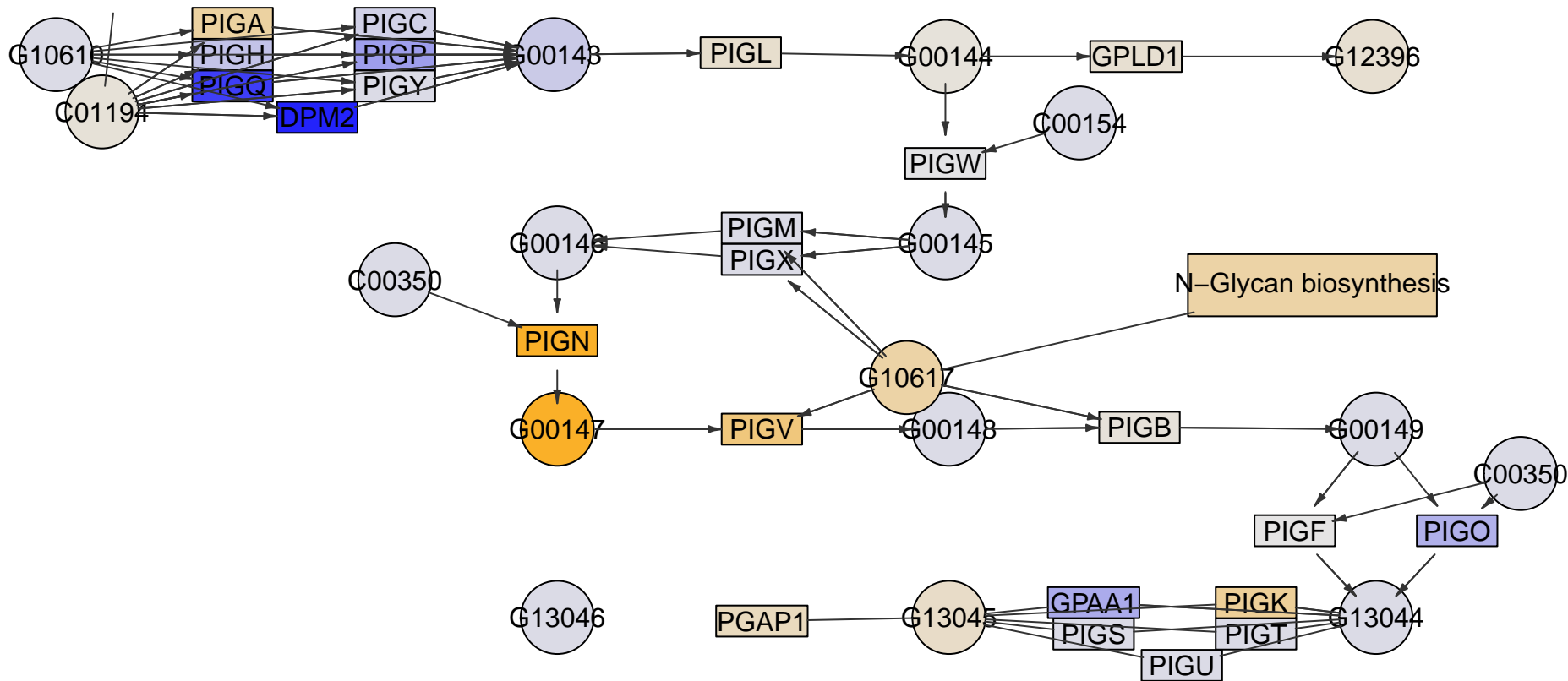

N-Glycan biosynthesis

PIGK

PIGO

PIGG

PIGN

PIGZ

PIGB

PIGV

PIGM

PIGA

Glycosylphosphatidylinositol(GPI)-anchor
biosynthesis
MPI-046

Glycerophospholipid
metabolism

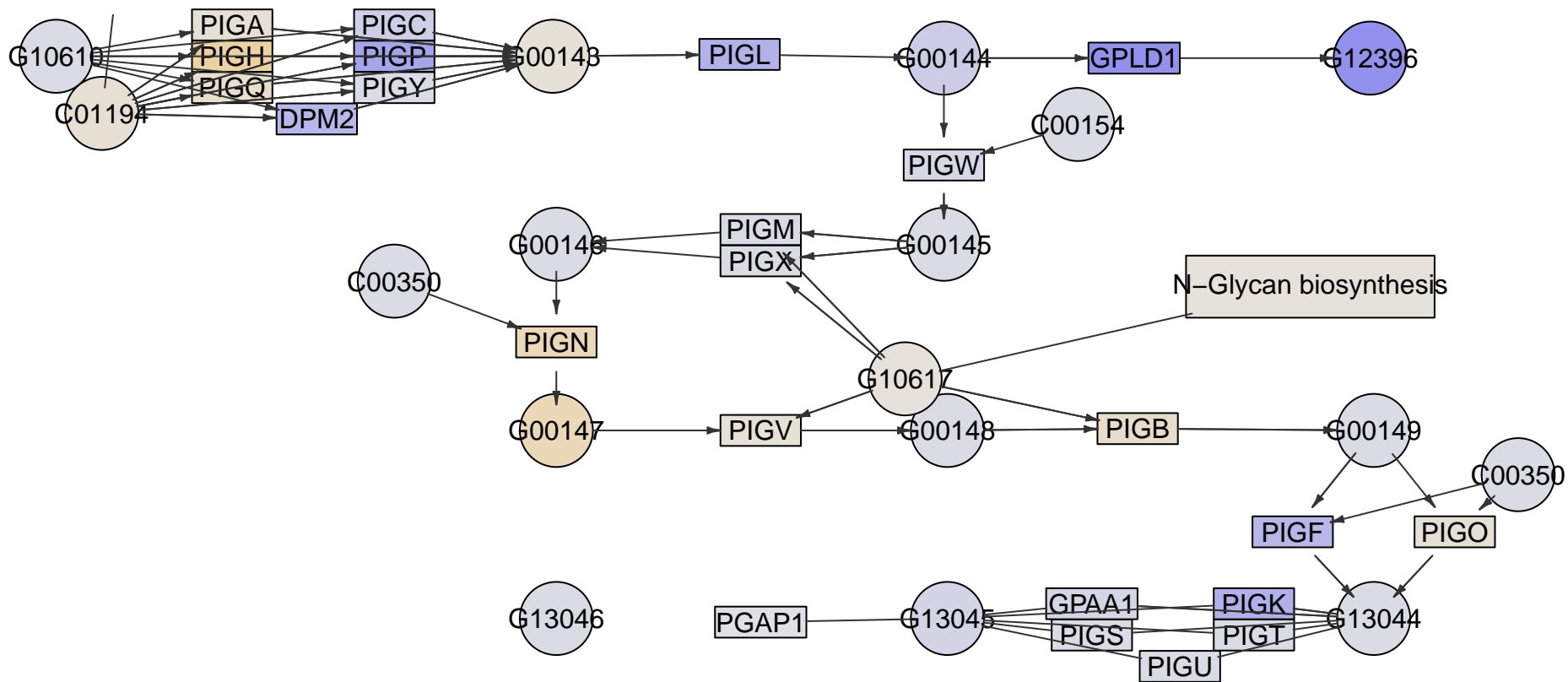

PIGK

PIGO

PIGG

PIGN

PIGZ

PIGB

PIGV

PIGM

PIGA

Glycosylphosphatidylinositol(GPI)-anchor
biosynthesis
MPI-050

Glycerophospholipid
metabolism

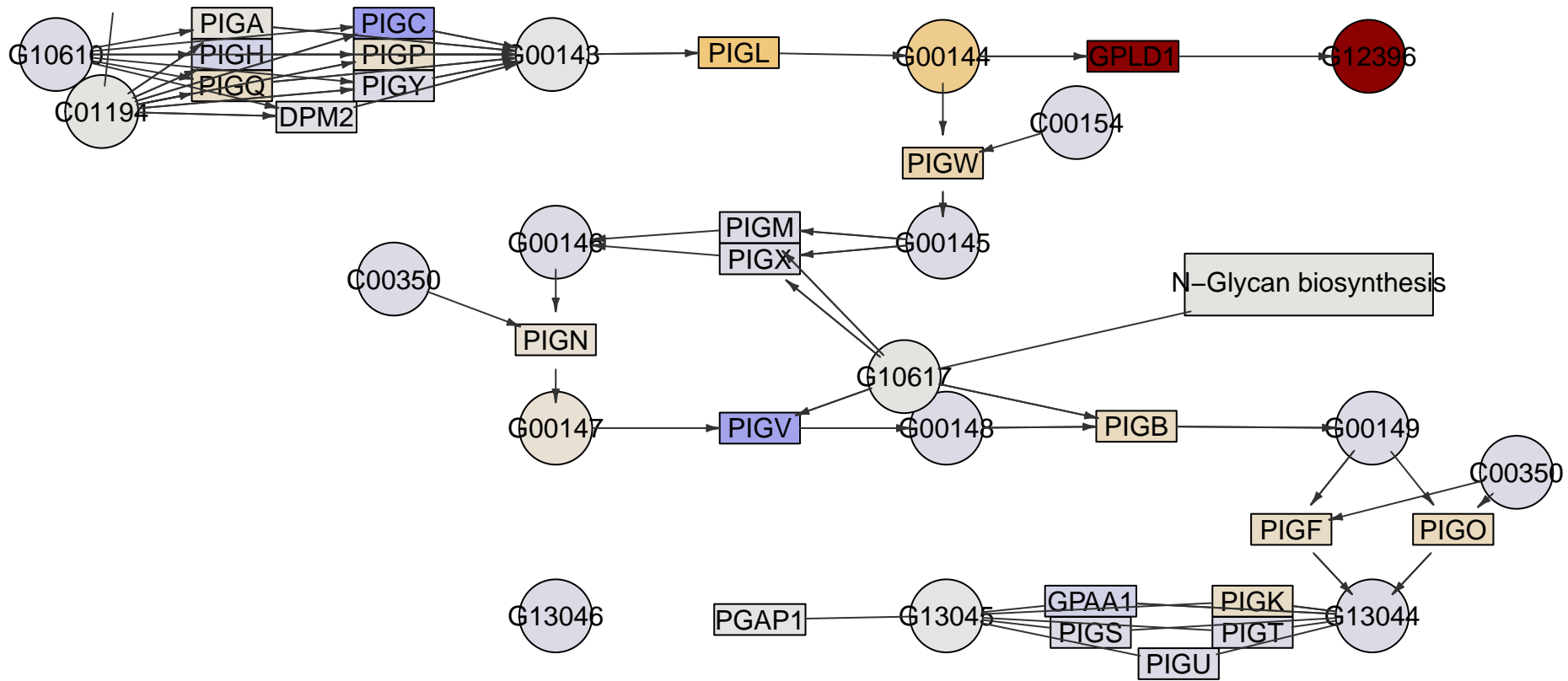

PIGK

PIGO

PIGG

PIGN

PIGZ

PIGB

PIGV

PIGM

PIGA

Glycosylphosphatidylinositol(GPI)-anchor
biosynthesis
MPI-051

Glycerophospholipid
metabolism

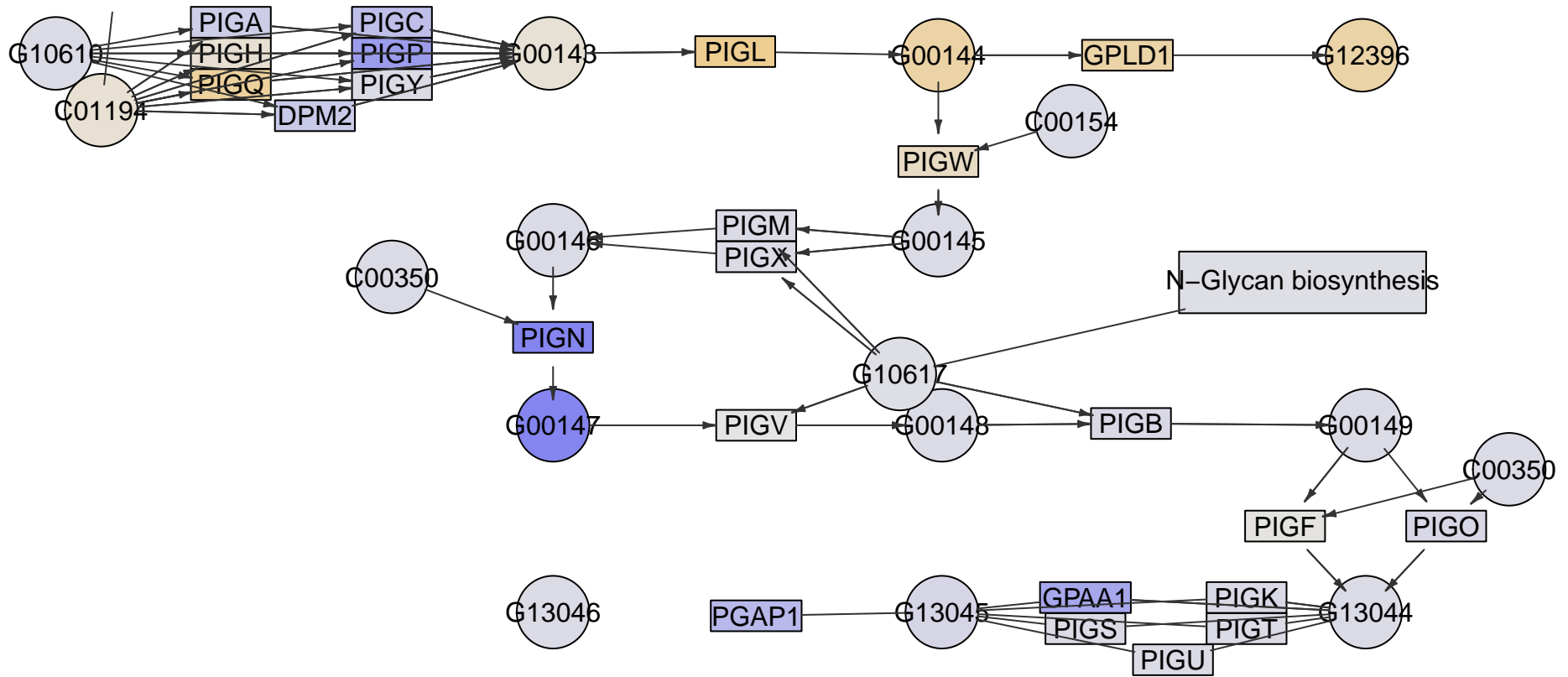

N-Glycan biosynthesis

PIGK

PIGO

PIGG

PIGN

PIGZ

PIGB

PIGV

PIGM

PIGA

Glycosylphosphatidylinositol(GPI)-anchor
biosynthesis
MPI-054

Glycerophospholipid
metabolism

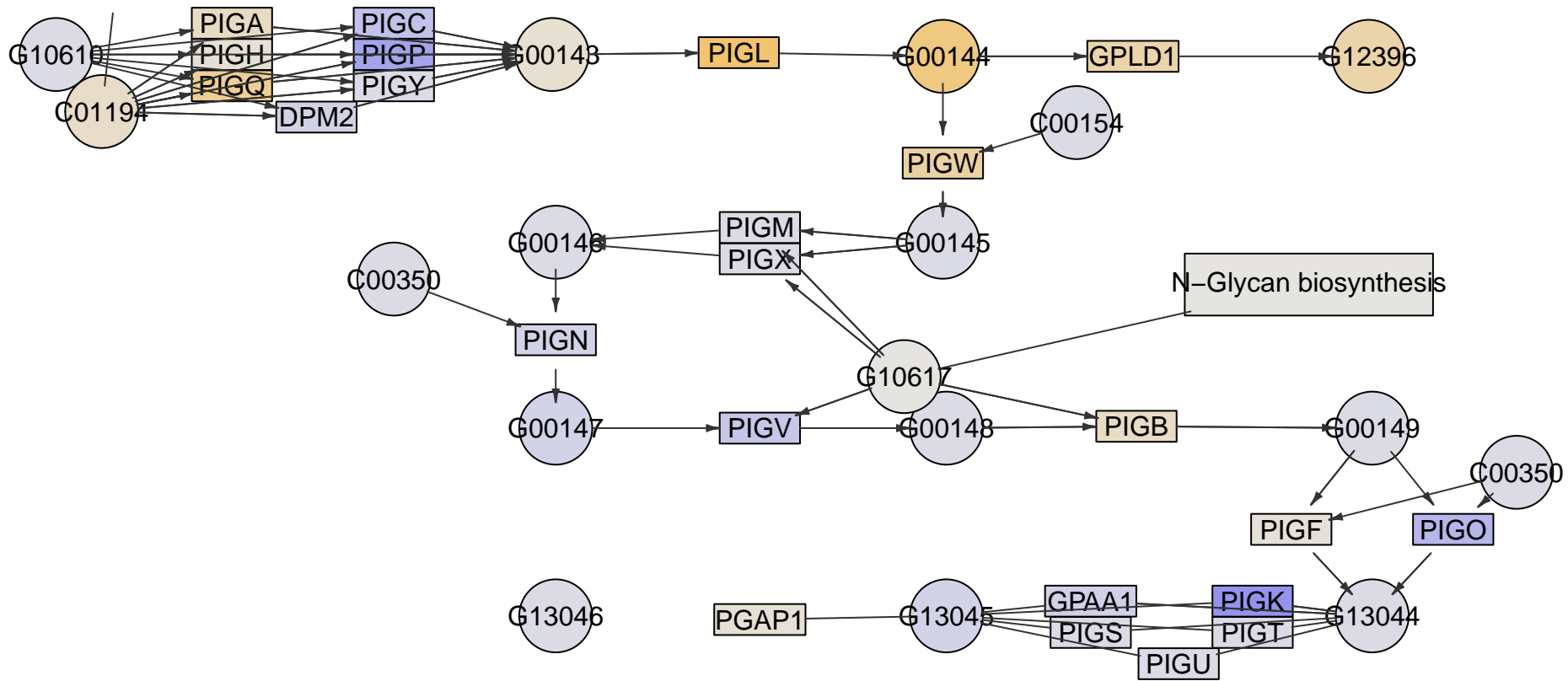

PIGK

PIGO

PIGG

PIGN

PIGZ

PIGB

PIGV

PIGM

PIGA

Glycosylphosphatidylinositol(GPI)-anchor
biosynthesis
MPI-059

Glycerophospholipid
metabolism

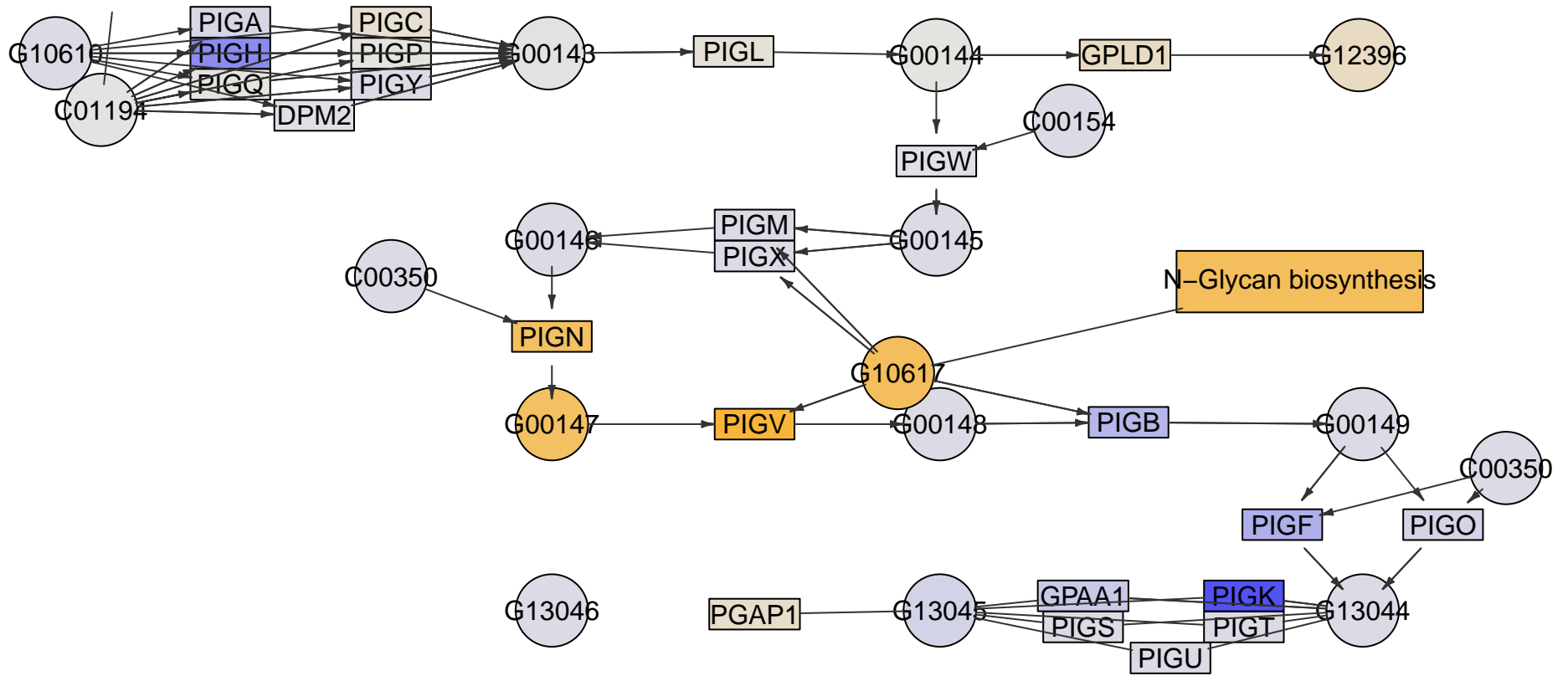

PIGK

PIGO

PIGG

PIGN

PIGZ

PIGB

PIGV

PIGM

PIGA

Glycosylphosphatidylinositol(GPI)-anchor
biosynthesis
MPI-060

Glycerophospholipid
metabolism

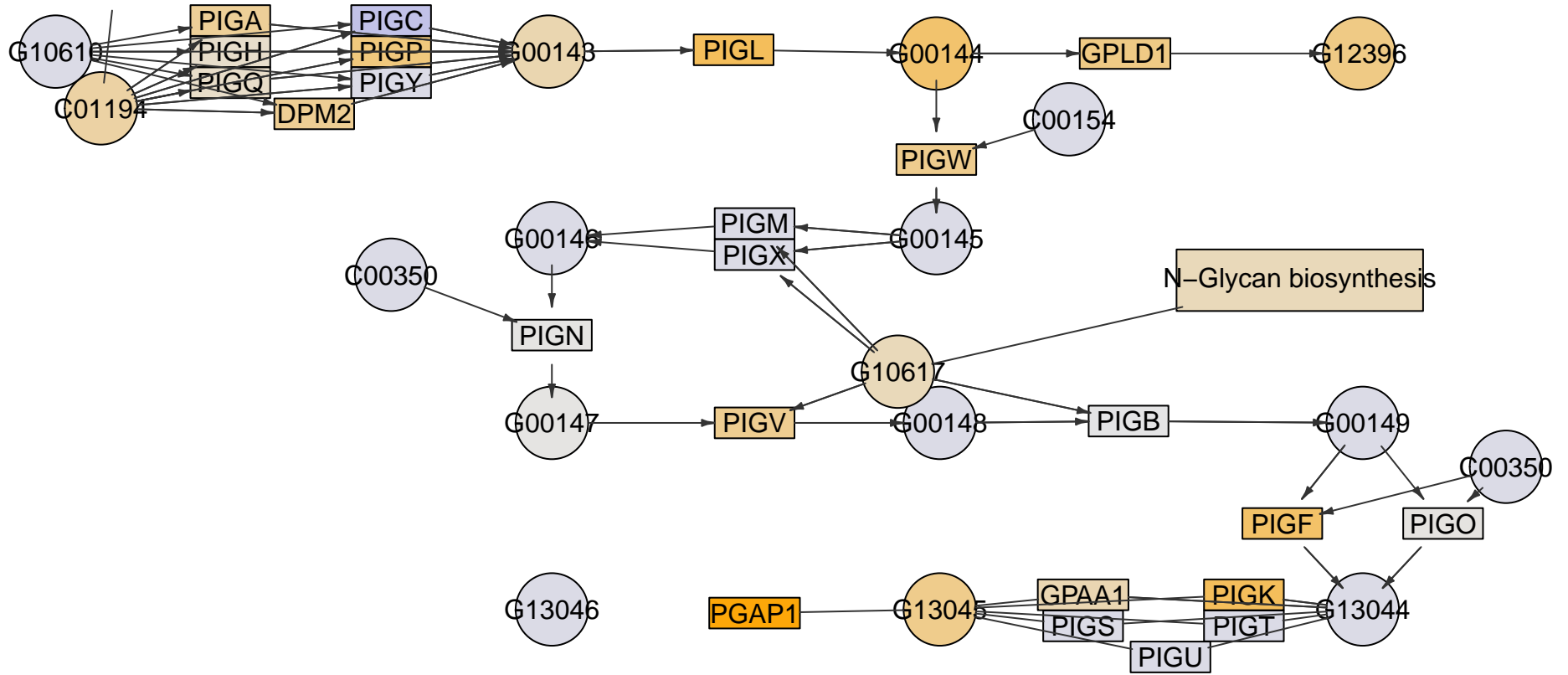

PIGK

PIGO

PIGG

PIGN

PIGZ

PIGB

PIGV

PIGM

PIGA

Glycosylphosphatidylinositol(GPI)-anchor
biosynthesis
MPI-061

Glycerophospholipid
metabolism

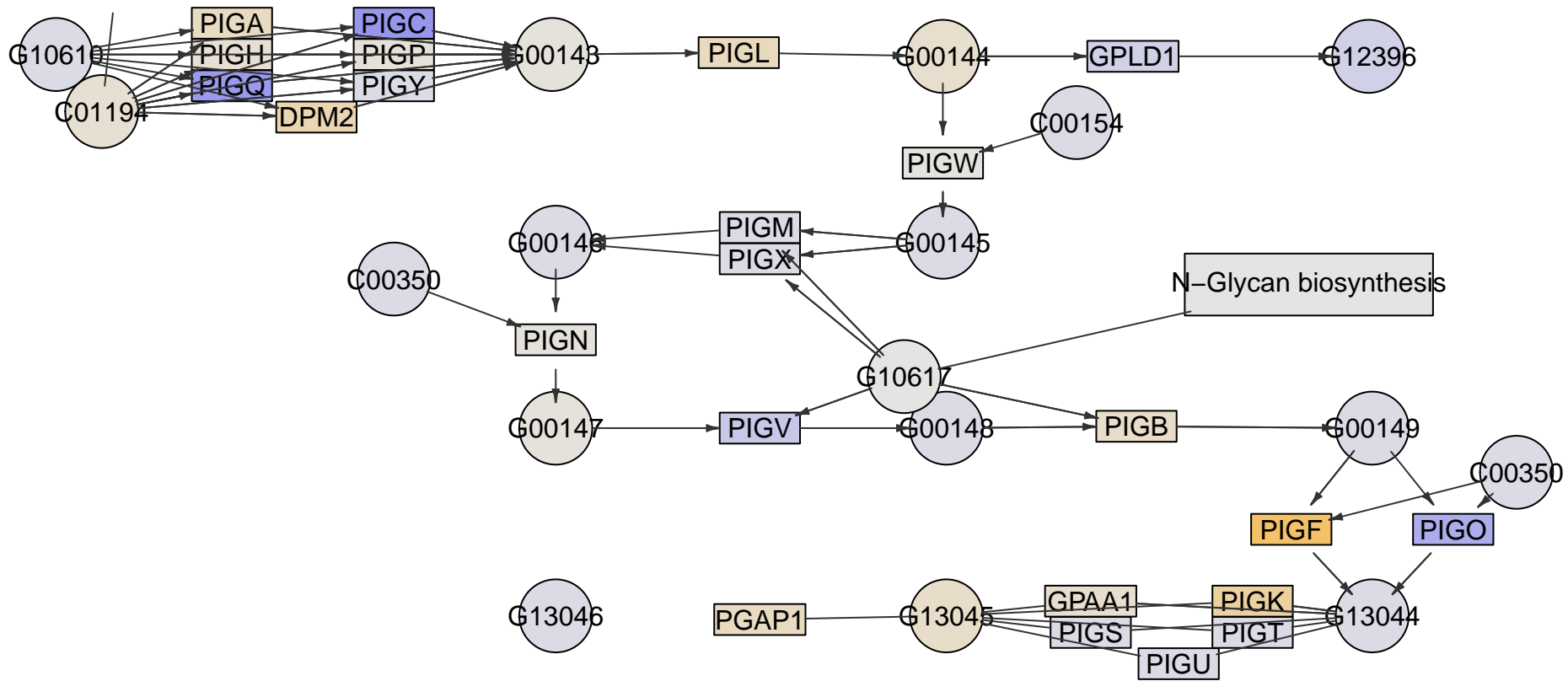

PIGK

PIGO

PIGG

PIGN

PIGZ

PIGB

PIGV

PIGM

PIGA

Glycosylphosphatidylinositol(GPI)-anchor
biosynthesis
MPI-064

Glycerophospholipid
metabolism

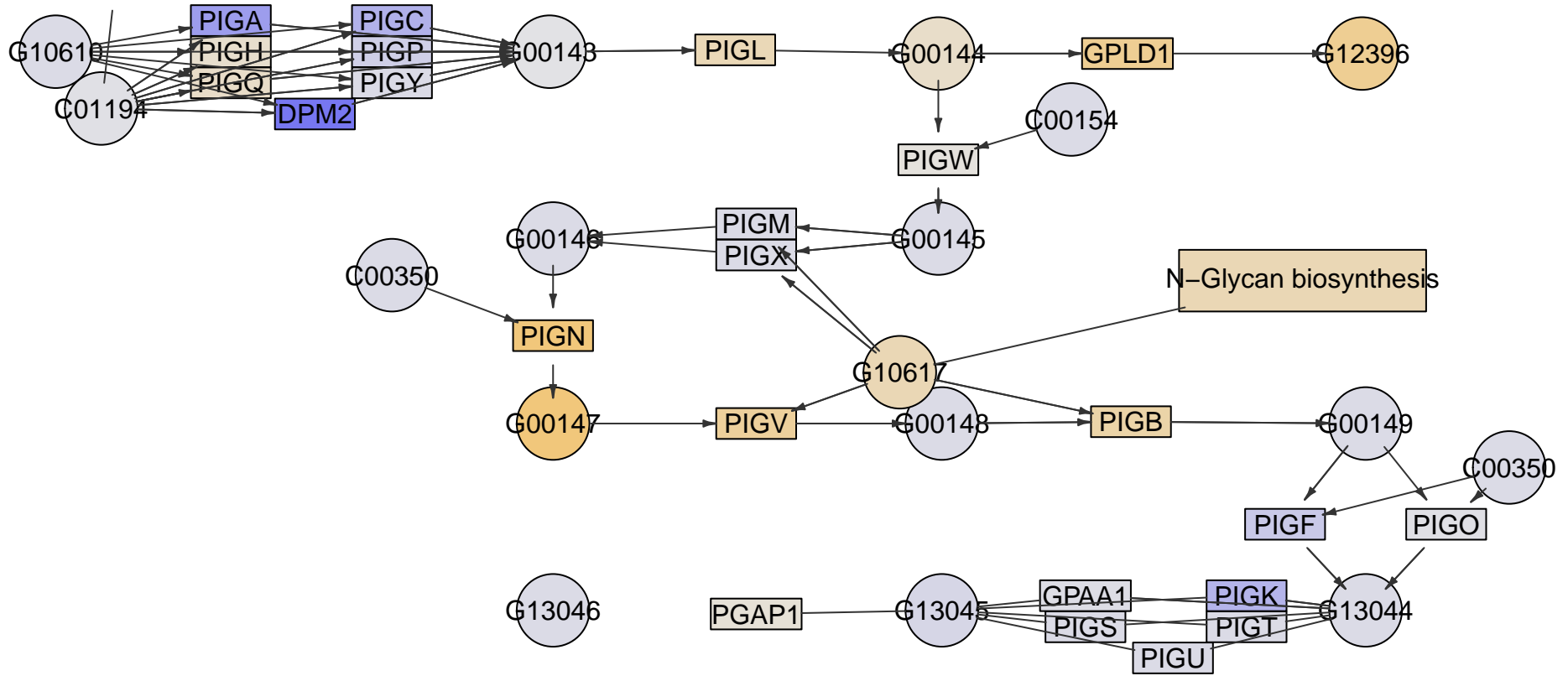

PIGK

PIGO

PIGG

PIGN

PIGZ

PIGB

PIGV

PIGM

PIGA

Glycosylphosphatidylinositol(GPI)-anchor
biosynthesis
MPI-070

Glycerophospholipid
metabolism

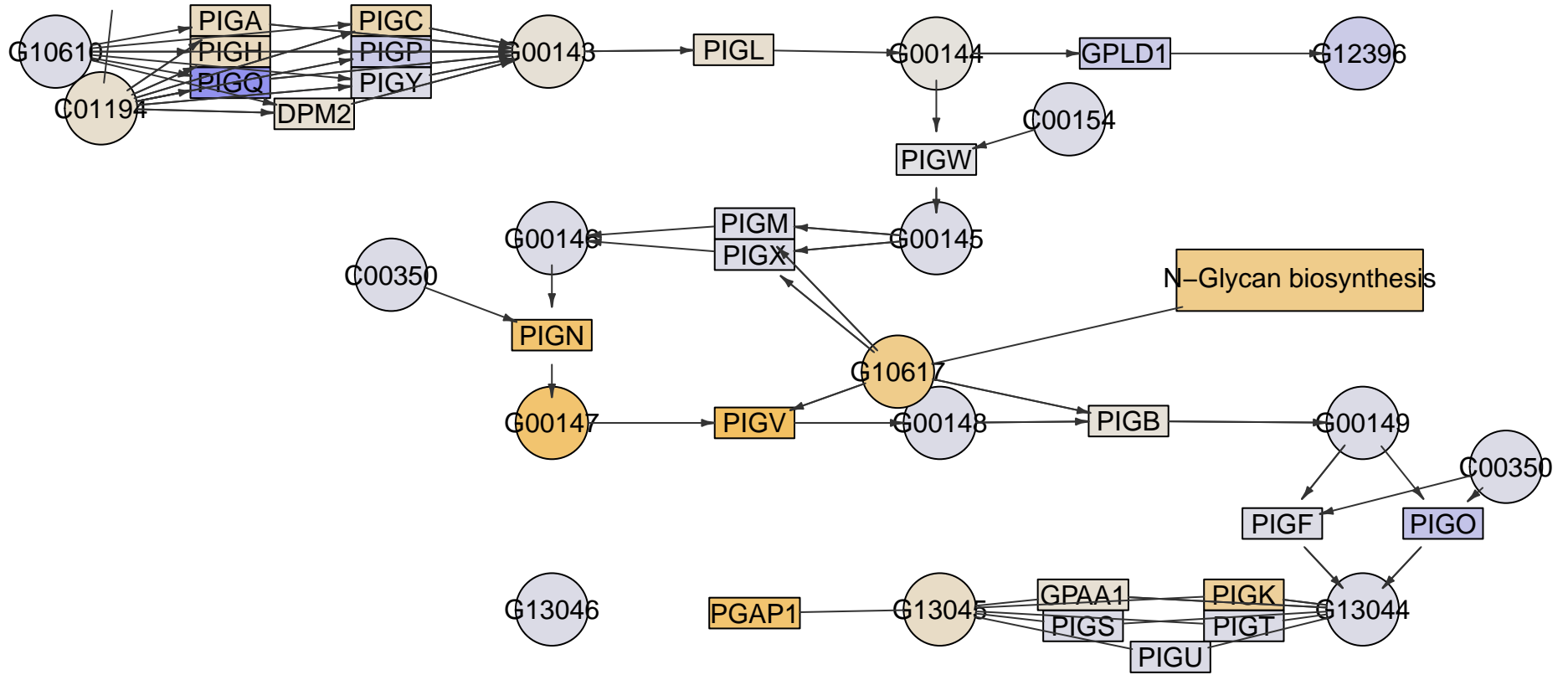

N-Glycan biosynthesis

PIGK

PIGO

PIGG

PIGN

PIGZ

PIGB

PIGV

PIGM

PIGA

Glycosylphosphatidylinositol(GPI)-anchor
biosynthesis
MPI-072

Glycerophospholipid
metabolism

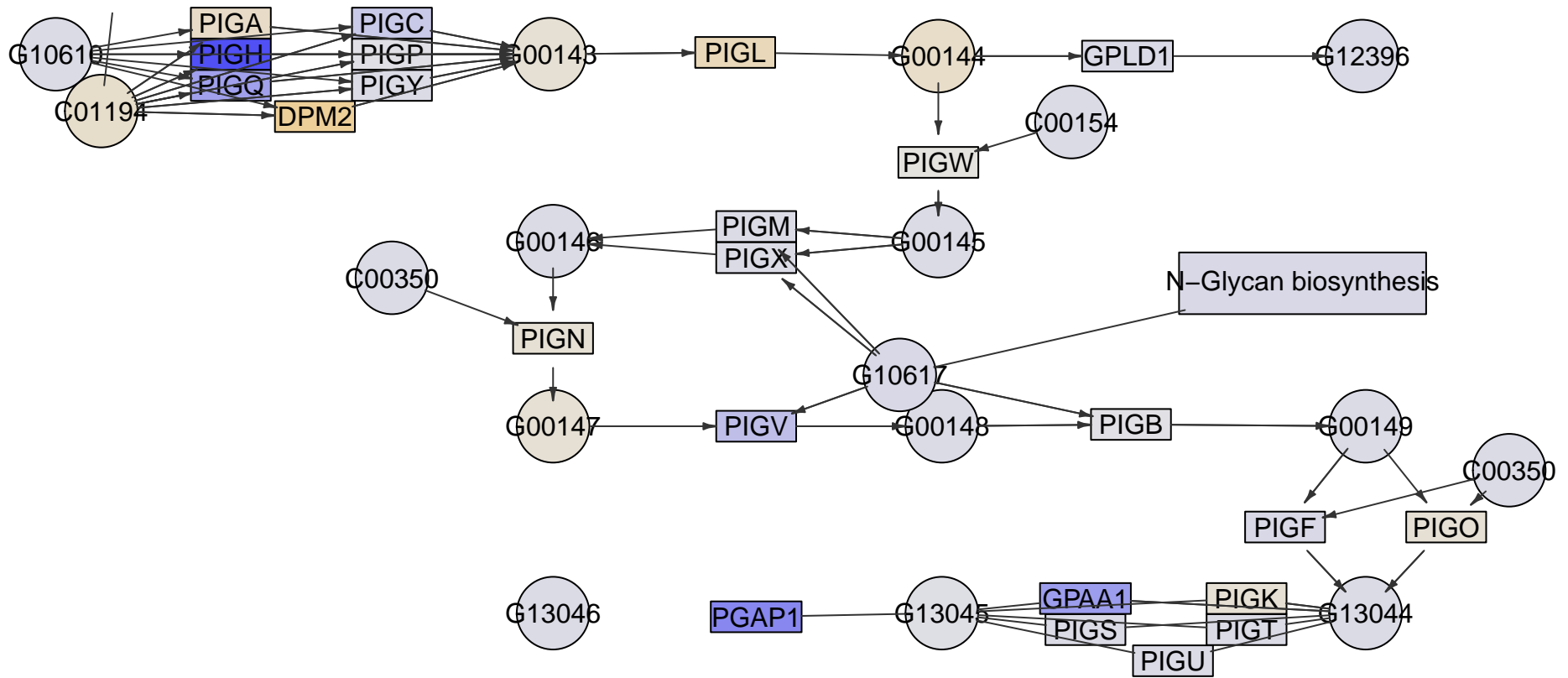

PIGK

PIGO

PIGG

PIGN

PIGZ

PIGB

PIGV

PIGM

PIGA

Glycosylphosphatidylinositol(GPI)-anchor
biosynthesis
MPI-093

Glycerophospholipid
metabolism

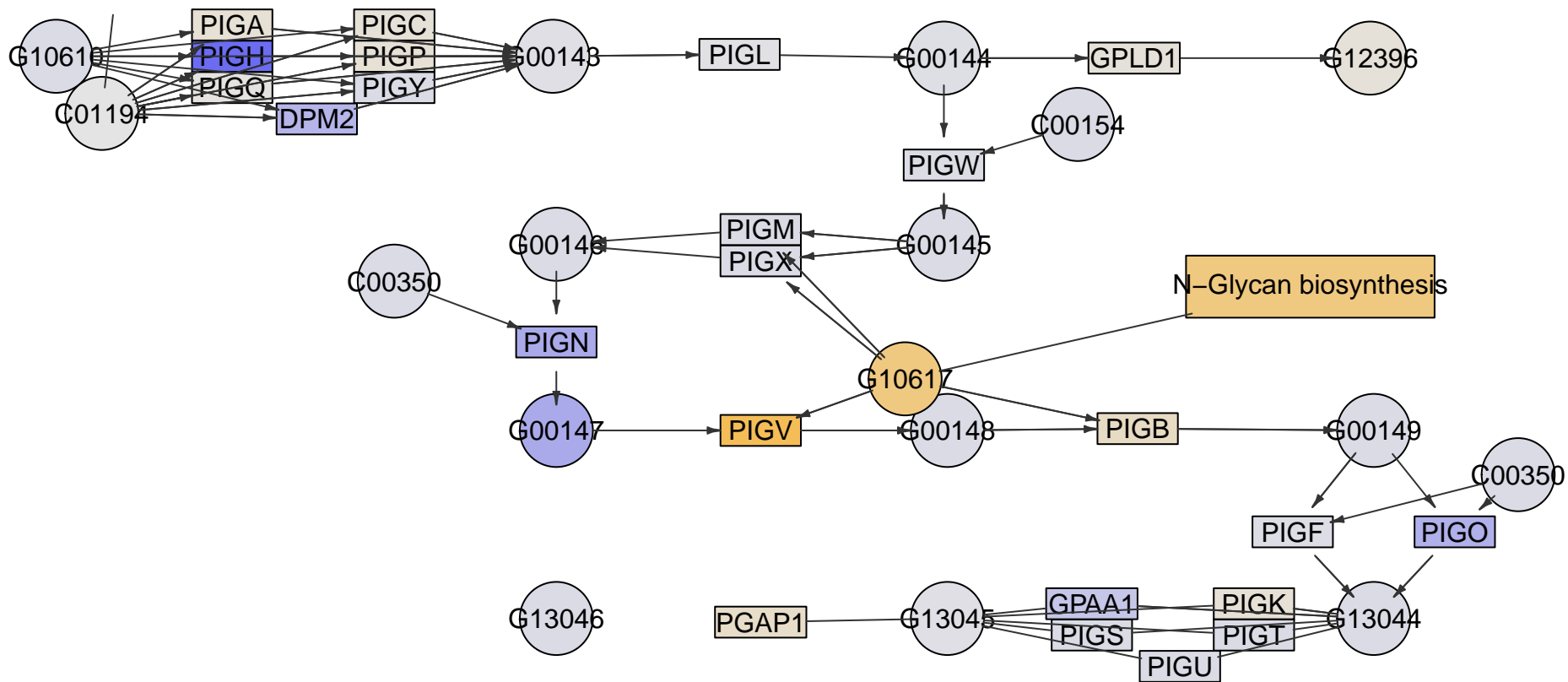

N-Glycan biosynthesis

PIGK

PIGO

PIGG

PIGN

PIGZ

PIGB

PIGV

PIGM

PIGA

Glycosylphosphatidylinositol(GPI)-anchor
biosynthesis
MPI-094

Glycerophospholipid
metabolism

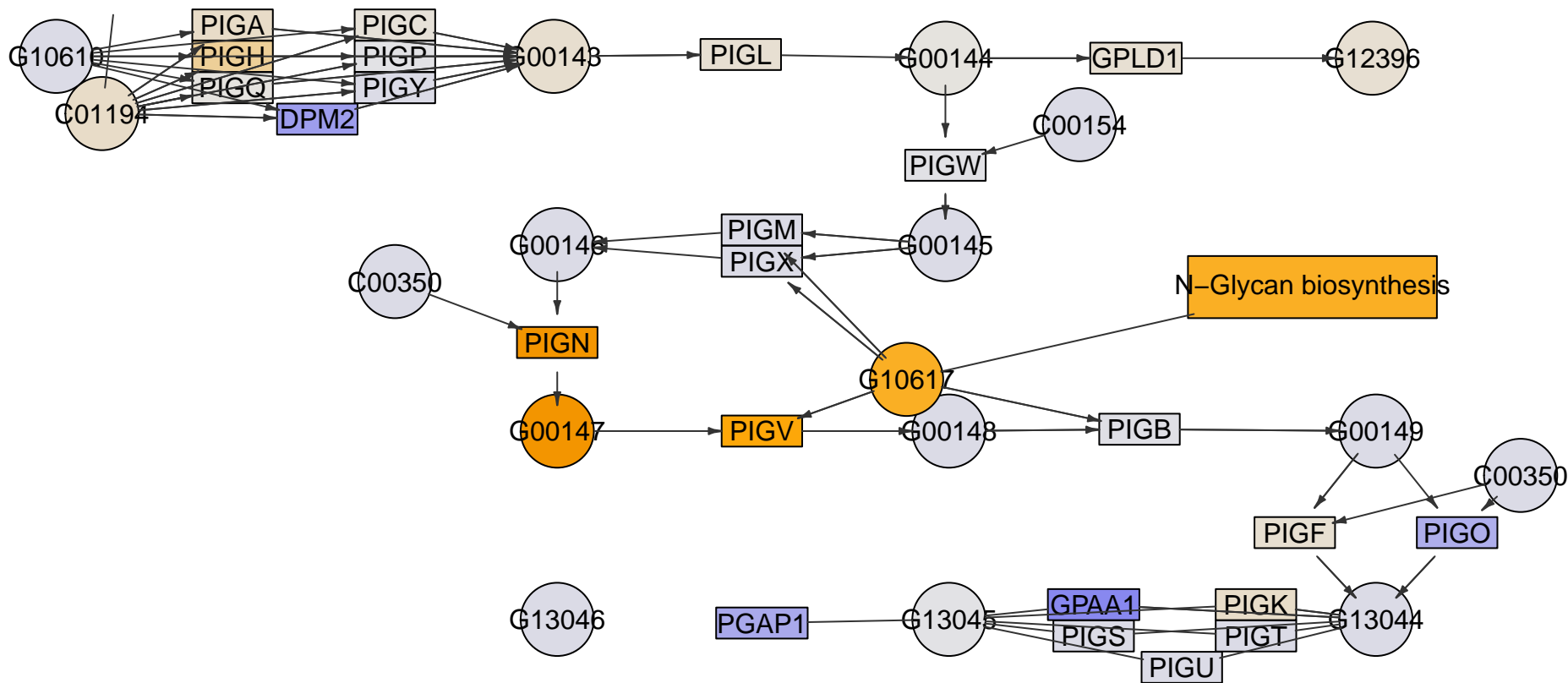

PIGK

PIGO

PIGG

PIGN

PIGZ

PIGB

PIGV

PIGM

PIGA

Glycosylphosphatidylinositol(GPI)-anchor
biosynthesis
MPI-099

Glycerophospholipid
metabolism

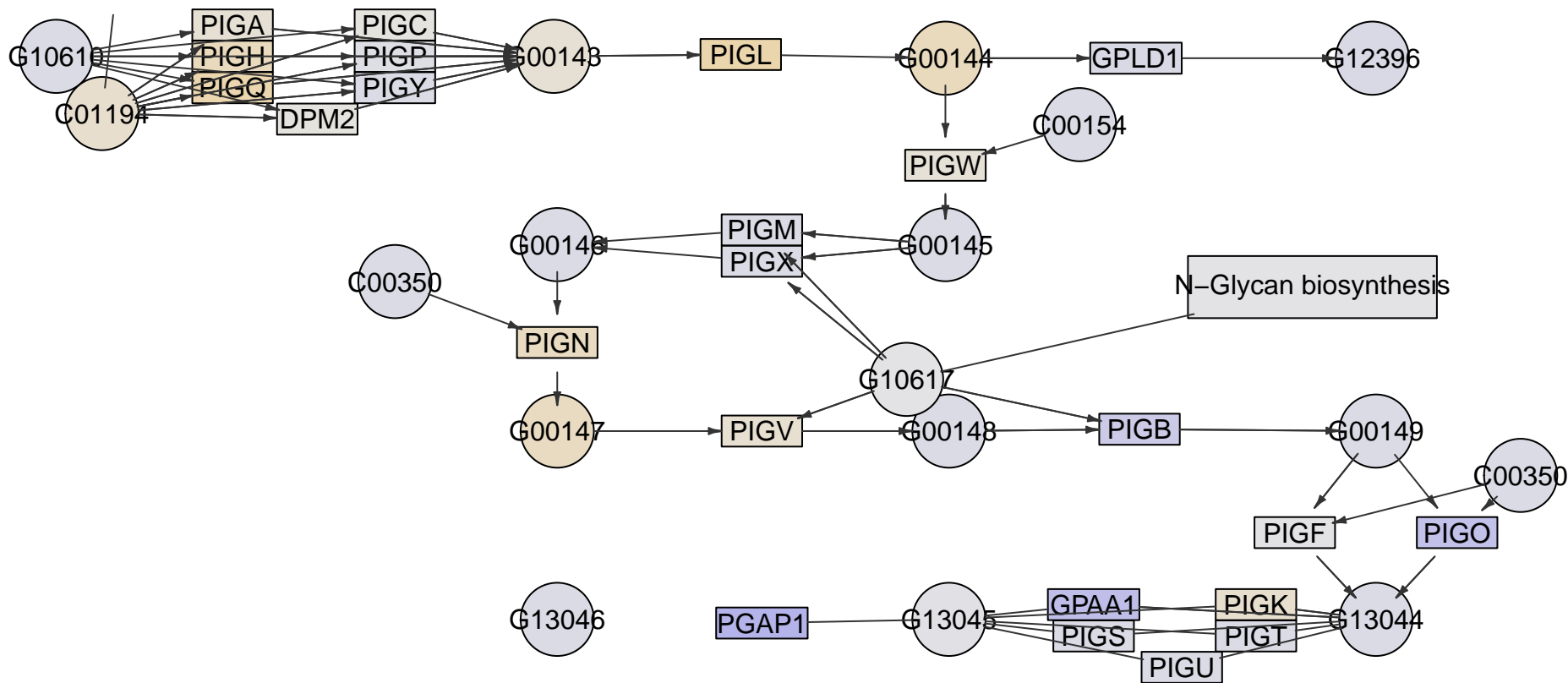

PIGK

PIGO

PIGG

PIGN

PIGZ

PIGB

PIGV

PIGM

PIGA

Glycosylphosphatidylinositol(GPI)-anchor
biosynthesis
MPI-104

Glycerophospholipid
metabolism

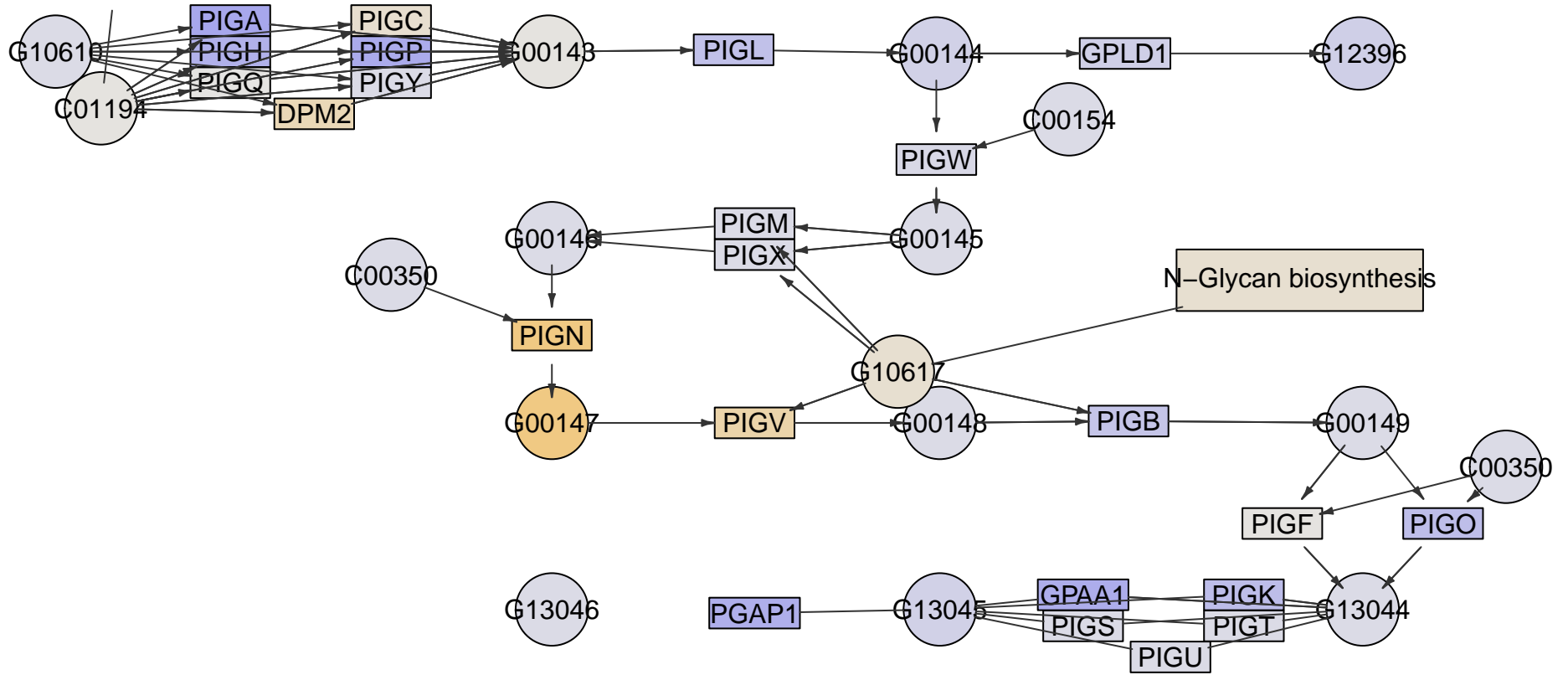

PIGK

PIGO

PIGG

PIGN

PIGZ

PIGB

PIGV

PIGM

PIGA

Glycosylphosphatidylinositol(GPI)-anchor
biosynthesis
MPI-107

Glycerophospholipid
metabolism

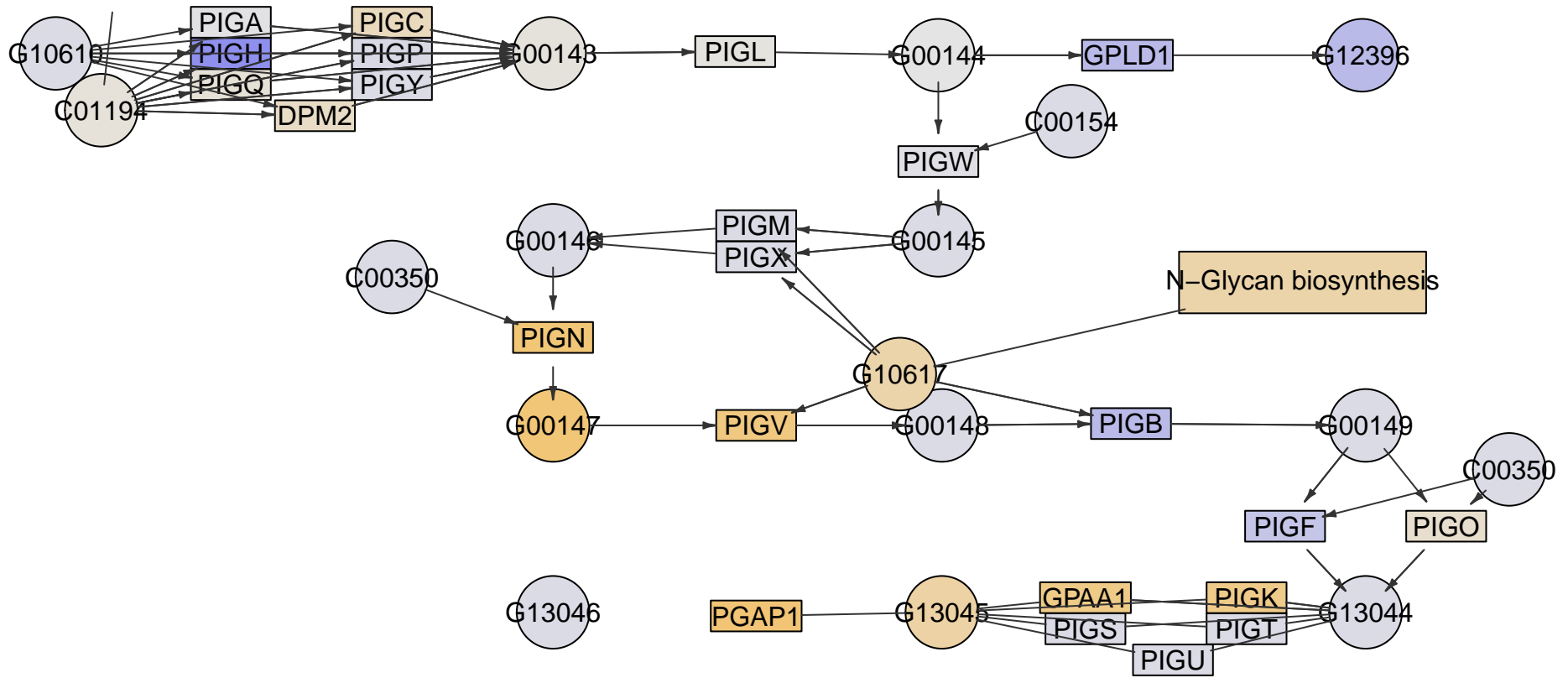

N-Glycan biosynthesis

PIGK

PIGO

PIGG

PIGN

PIGZ

PIGB

PIGV

PIGM

PIGA

Glycosylphosphatidylinositol(GPI)-anchor
biosynthesis
MPI-112

Glycerophospholipid
metabolism

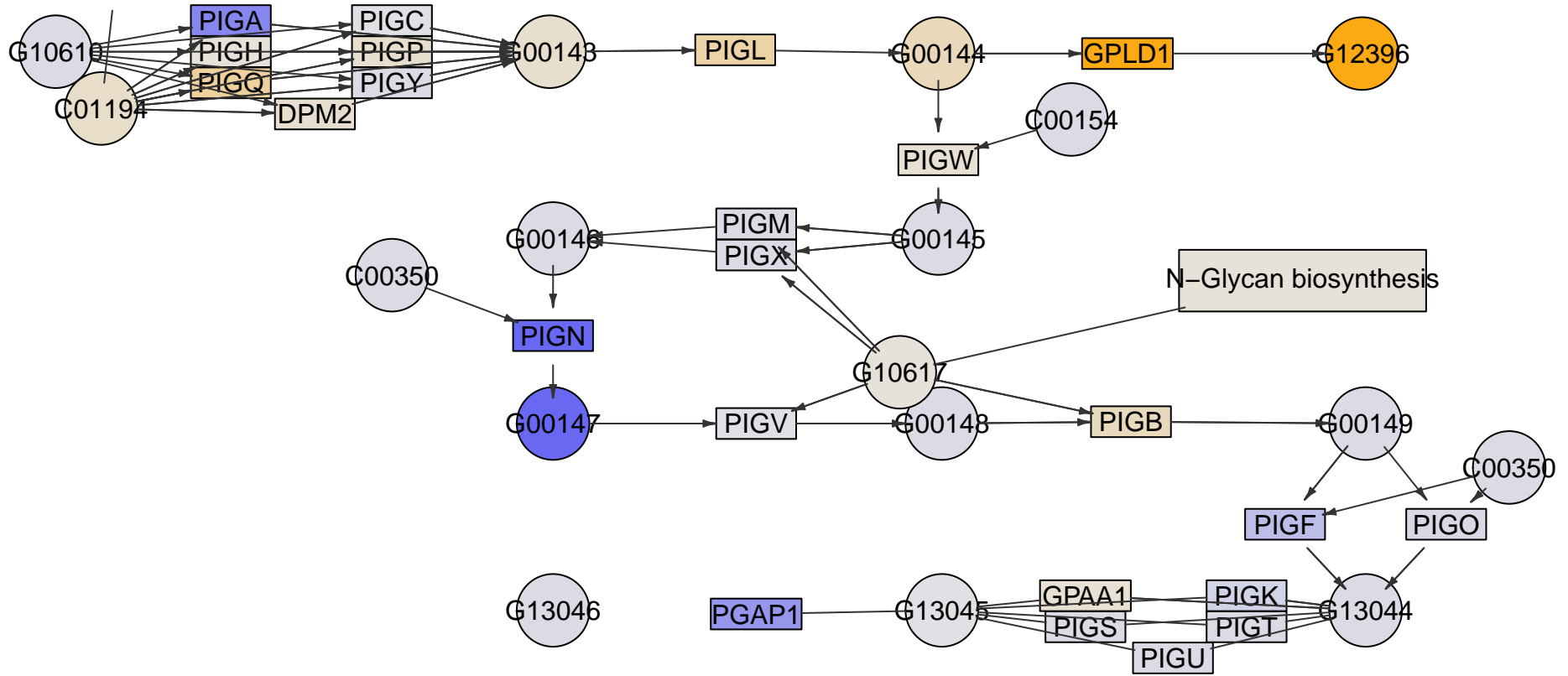

PIGK

PIGO

PIGG

PIGN

PIGZ

PIGB

PIGV

PIGM

PIGA

Glycosylphosphatidylinositol(GPI)-anchor
biosynthesis
MPI-116

Glycerophospholipid
metabolism

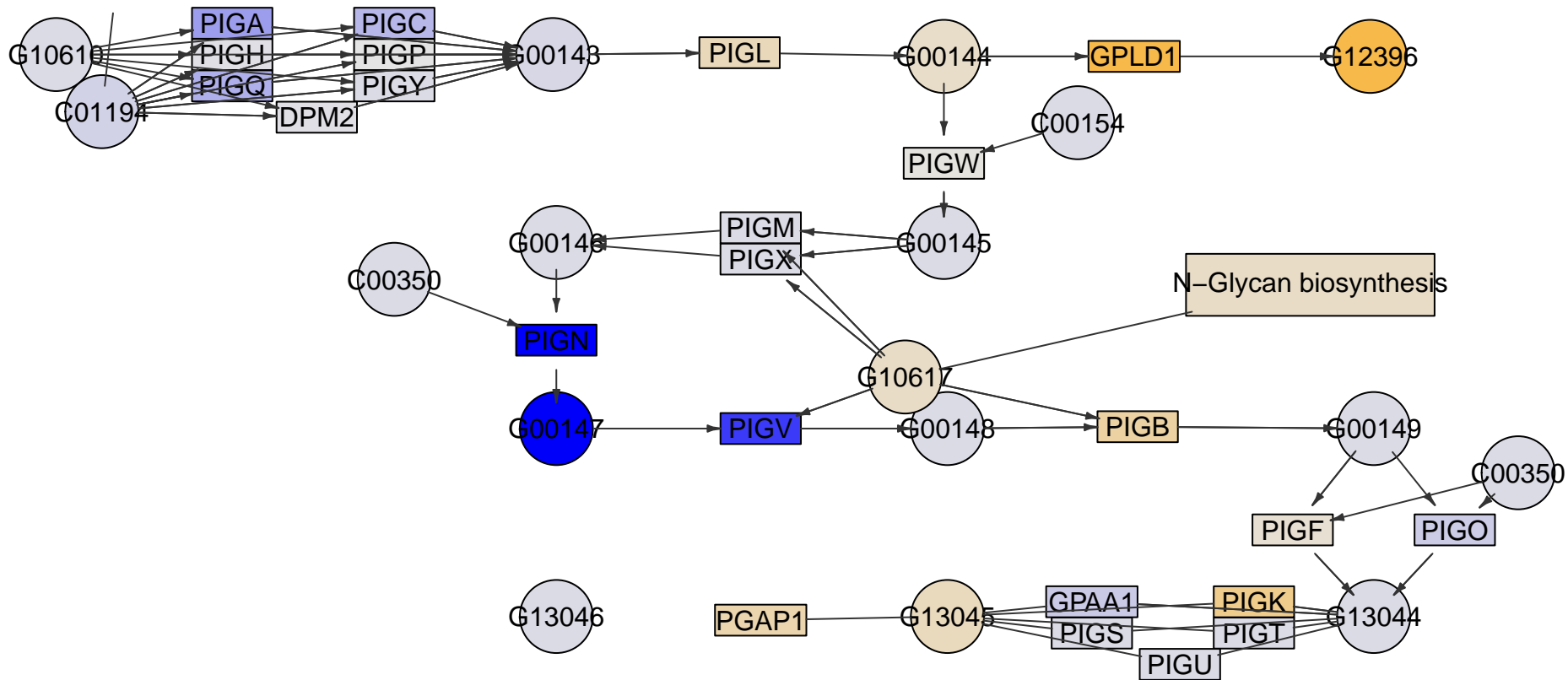

PIGK

PIGO

PIGG

PIGN

PIGZ

PIGB

PIGV

PIGM

PIGA

Glycosylphosphatidylinositol(GPI)-anchor
biosynthesis
MPI-117

Glycerophospholipid
metabolism

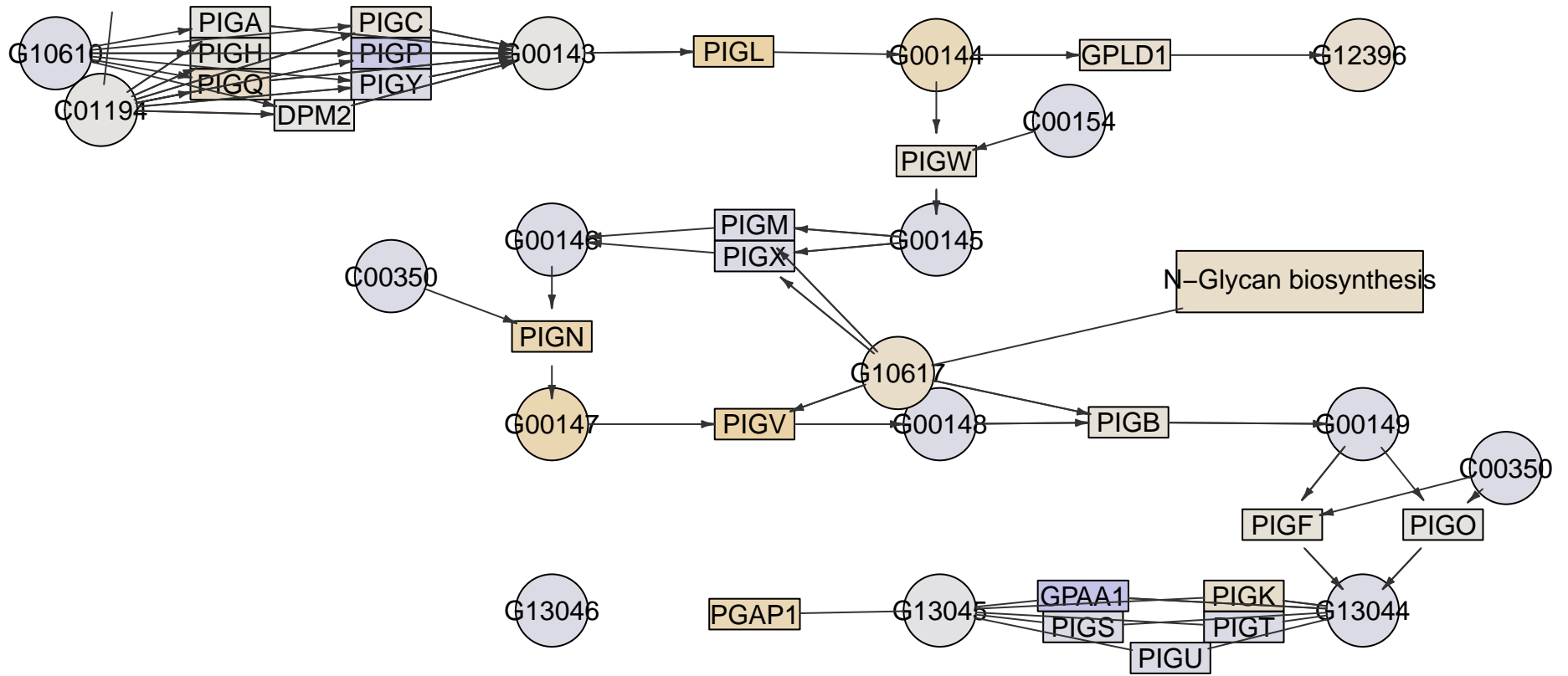

N-Glycan biosynthesis

PIGK

PIGO

PIGG

PIGN

PIGZ

PIGB

PIGV

PIGM

PIGA

Glycosylphosphatidylinositol(GPI)-anchor
biosynthesis
MPI-120

Glycerophospholipid
metabolism

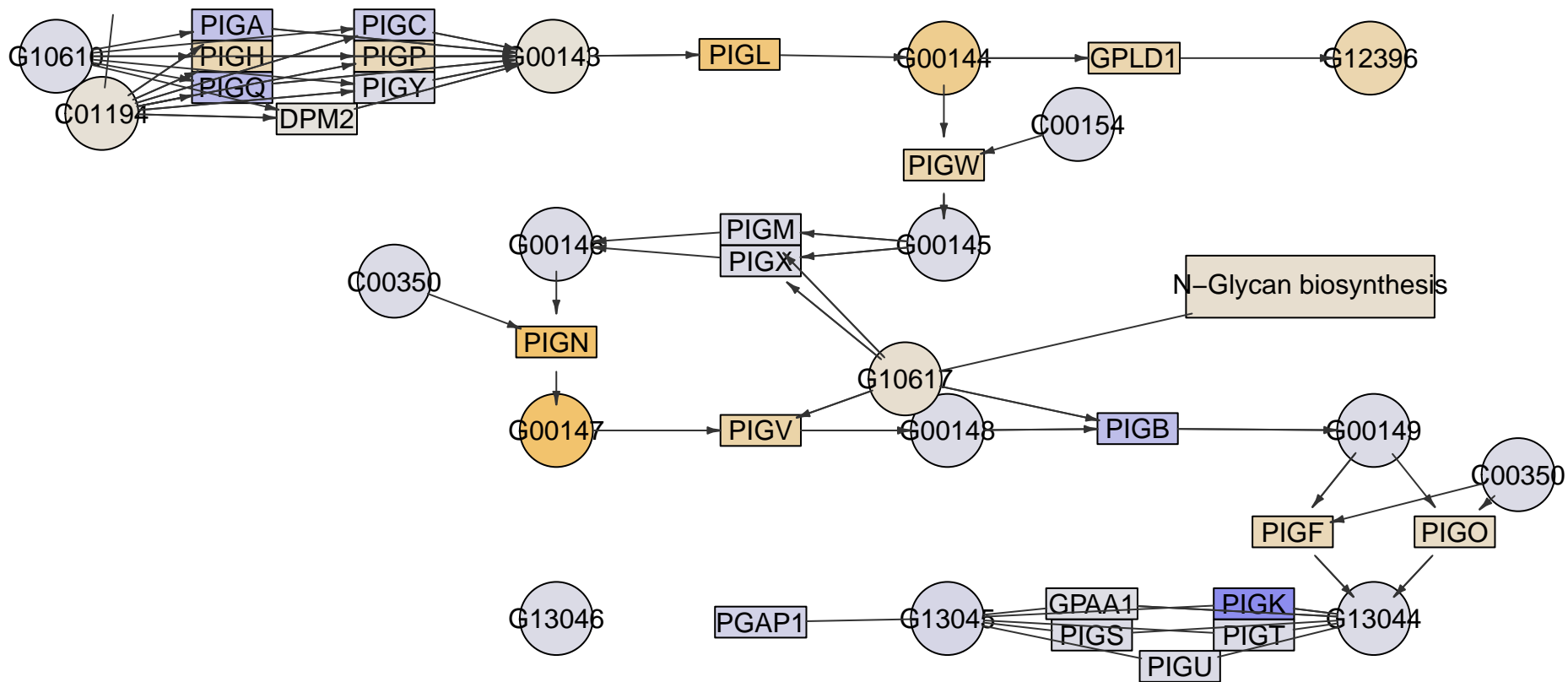

PIGK

PIGO

PIGG

PIGN

PIGZ

PIGB

PIGV

PIGM

PIGA

Glycosylphosphatidylinositol(GPI)-anchor
biosynthesis
MPI-121

Glycerophospholipid
metabolism

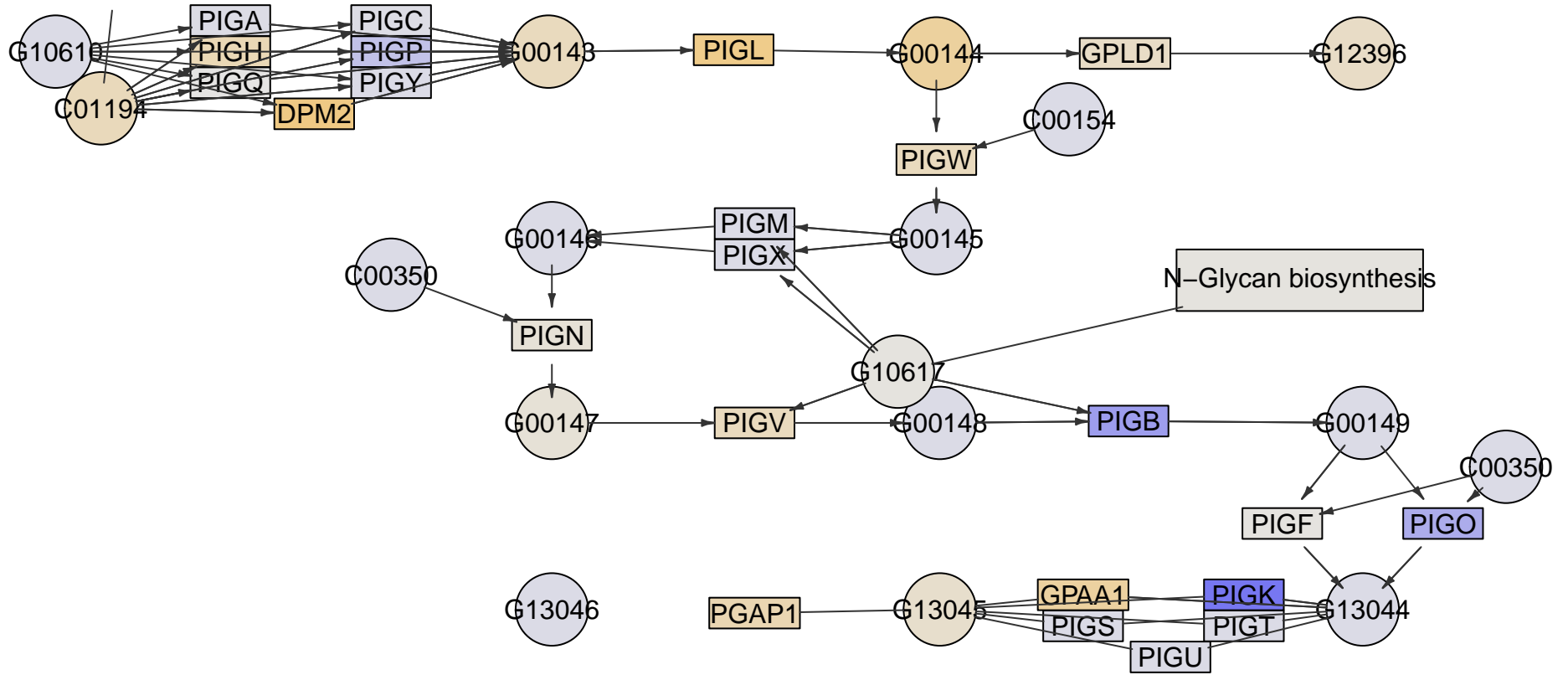

PIGK

PIGO

PIGG

PIGN

PIGZ

PIGB

PIGV

PIGM

PIGA

Glycosylphosphatidylinositol(GPI)-anchor
biosynthesis
MPI-124

Glycerophospholipid
metabolism

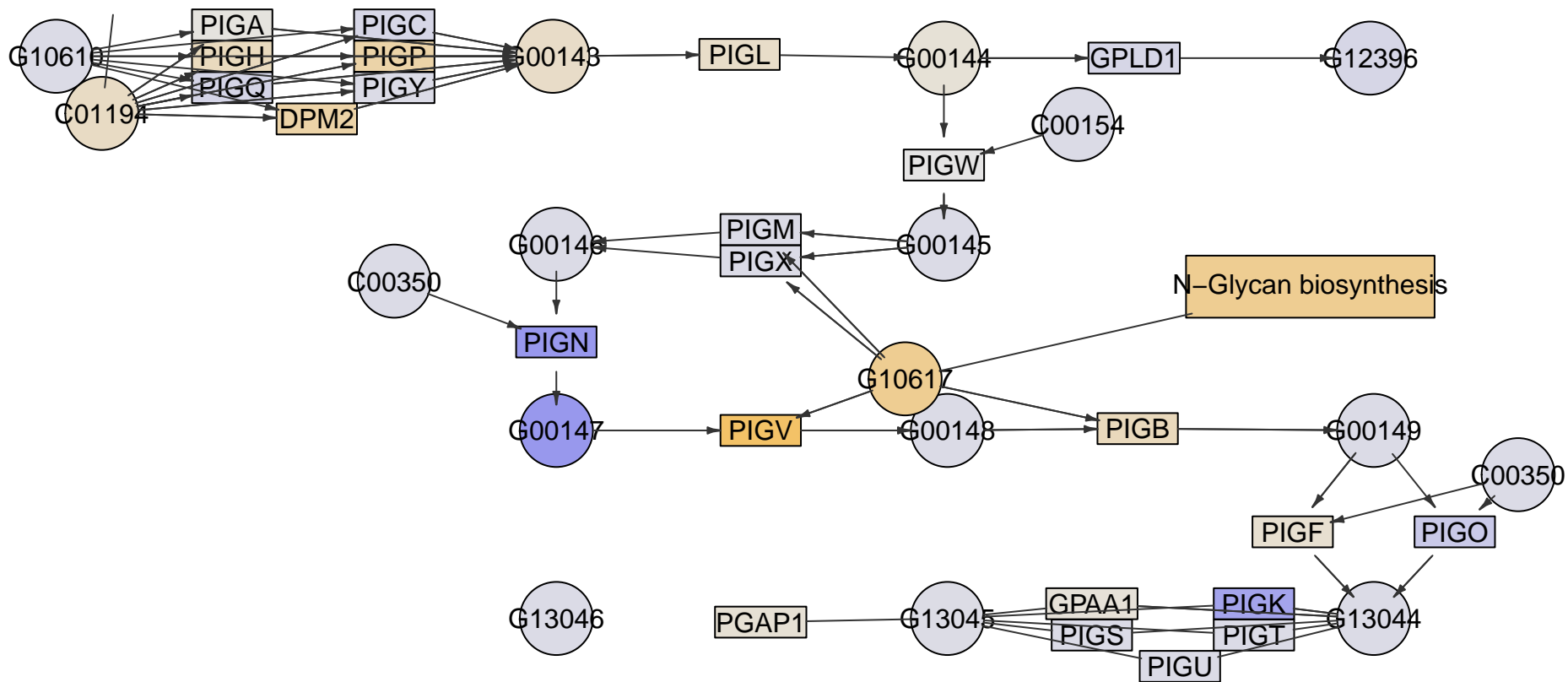

PIGK

PIGO

PIGG

PIGN

PIGZ

PIGB

PIGV

PIGM

PIGA

Glycosylphosphatidylinositol(GPI)-anchor
biosynthesis
MPI-126

Glycerophospholipid
metabolism

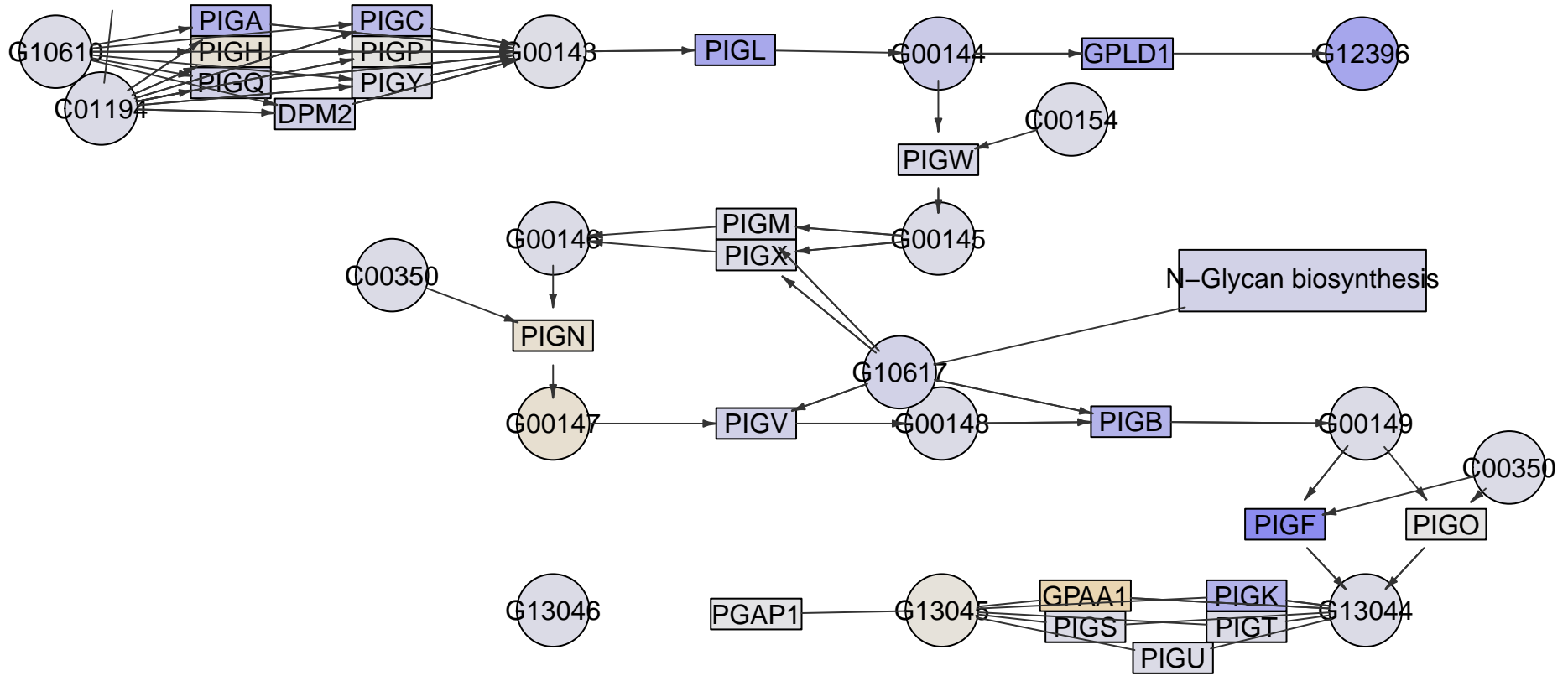

PIGK

PIGO

PIGG

PIGN

PIGZ

PIGB

PIGV

PIGM

PIGA

Glycosylphosphatidylinositol(GPI)-anchor
biosynthesis
MPI-131

Glycerophospholipid
metabolism

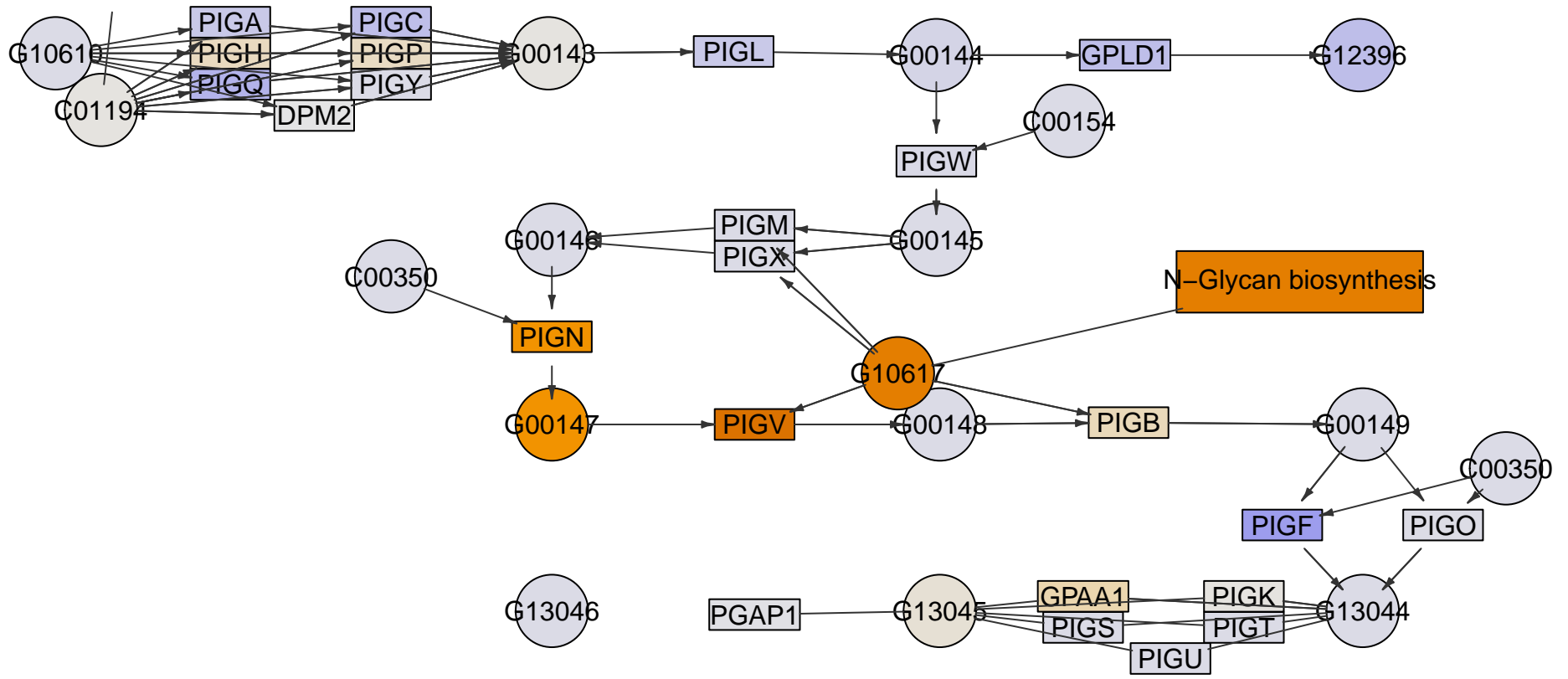

N-Glycan biosynthesis

- PIGK
- PIGO
- PIGG
- PIGN
- PIGZ
- PIGB
- PIGV
- PIGM
- PIGA

Glycosylphosphatidylinositol(GPI)-anchor
biosynthesis
MPI-143

Glycerophospholipid
metabolism

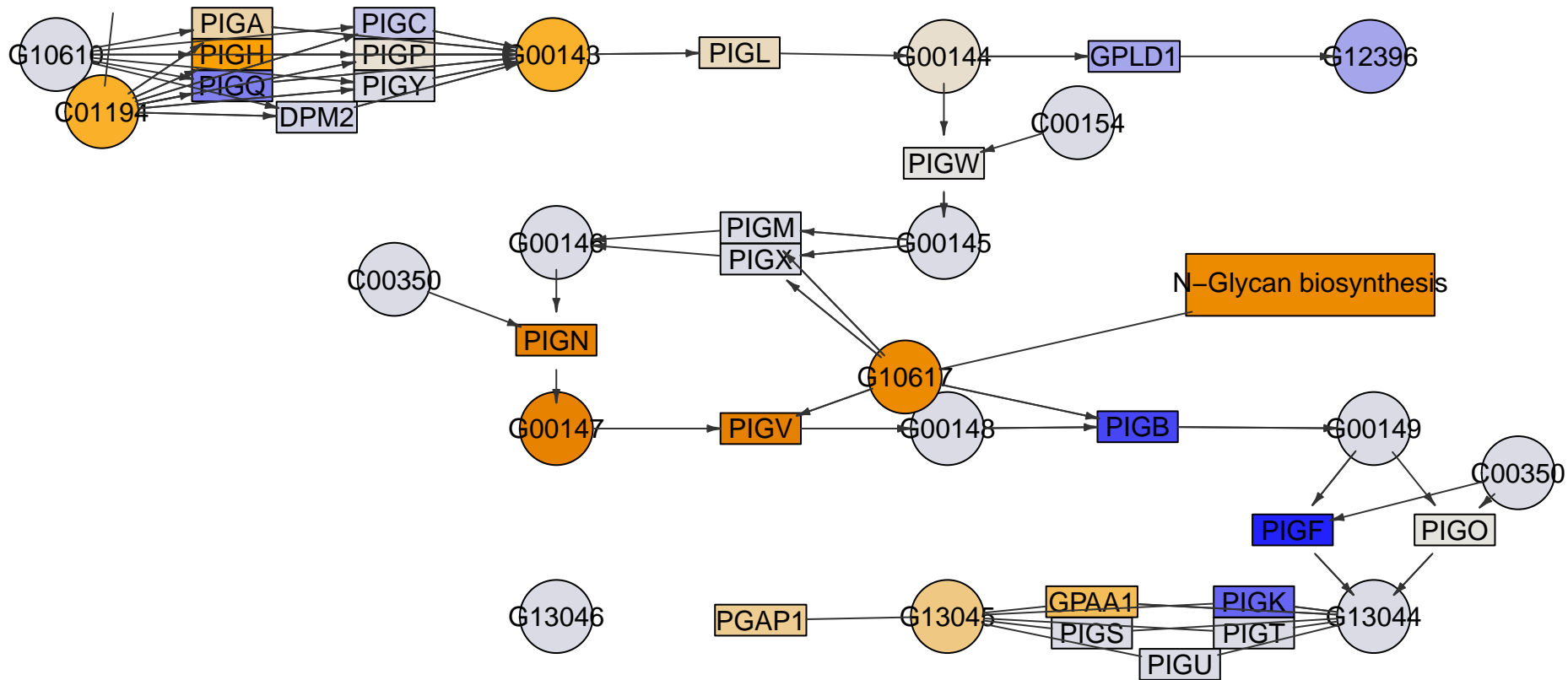

PIGK

PIGO

PIGG

PIGN

PIGZ

PIGB

PIGV

PIGM

PIGA

Glycosylphosphatidylinositol(GPI)-anchor
biosynthesis
MPI-148

Glycerophospholipid
metabolism

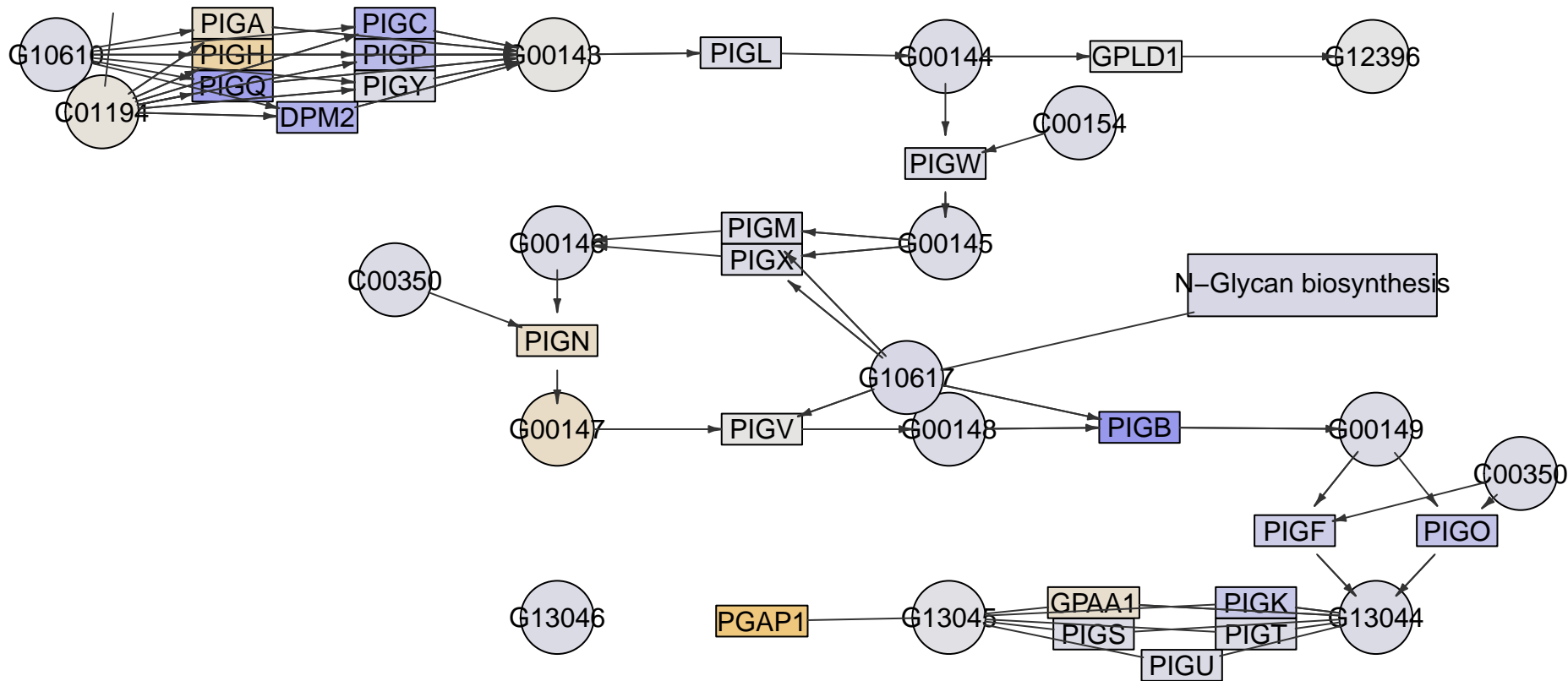

PIGK

PIGO

PIGG

PIGN

PIGZ

PIGB

PIGV

PIGM

PIGA

Glycosylphosphatidylinositol(GPI)-anchor
biosynthesis
MPI-161

Glycerophospholipid
metabolism

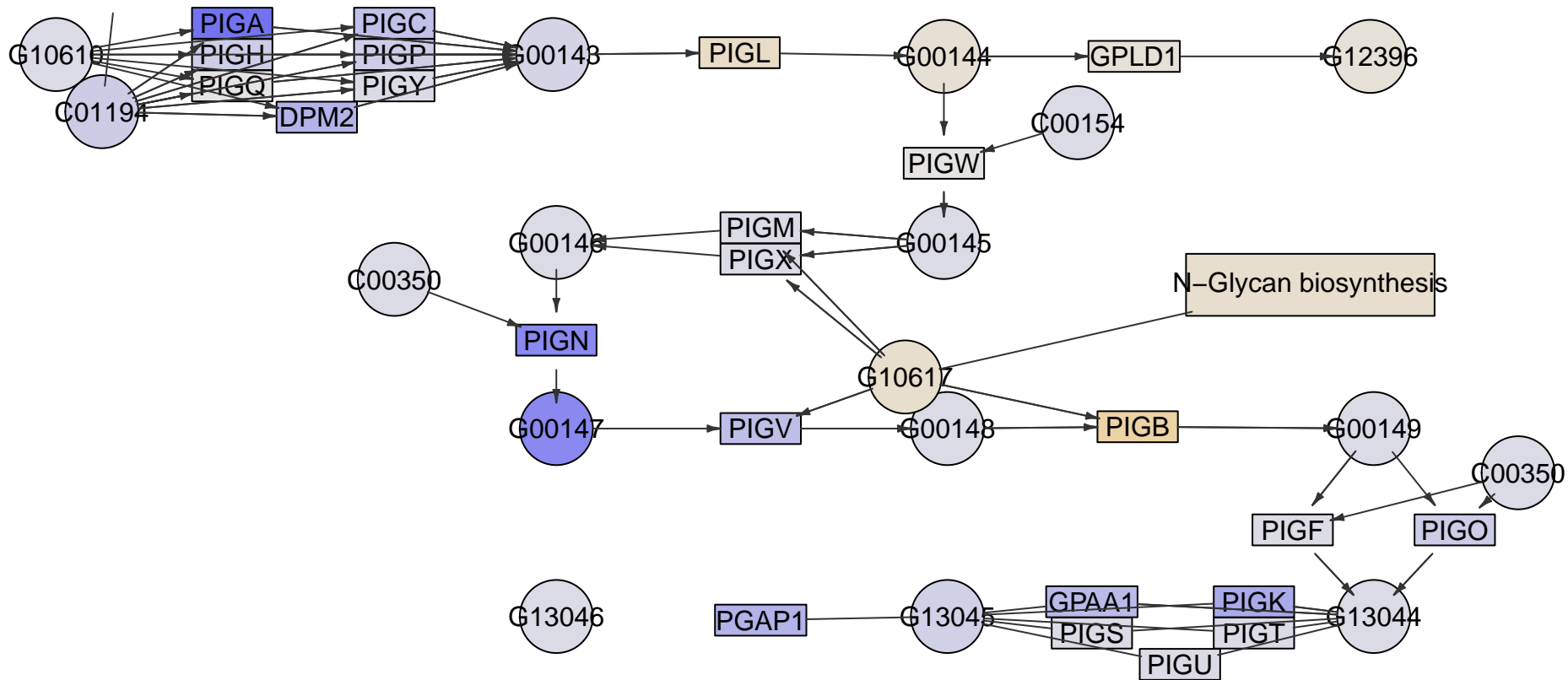

PIGK

PIGO

PIGG

PIGN

PIGZ

PIGB

PIGV

PIGM

PIGA

Glycosylphosphatidylinositol(GPI)-anchor
biosynthesis
MPI-162

Glycerophospholipid
metabolism

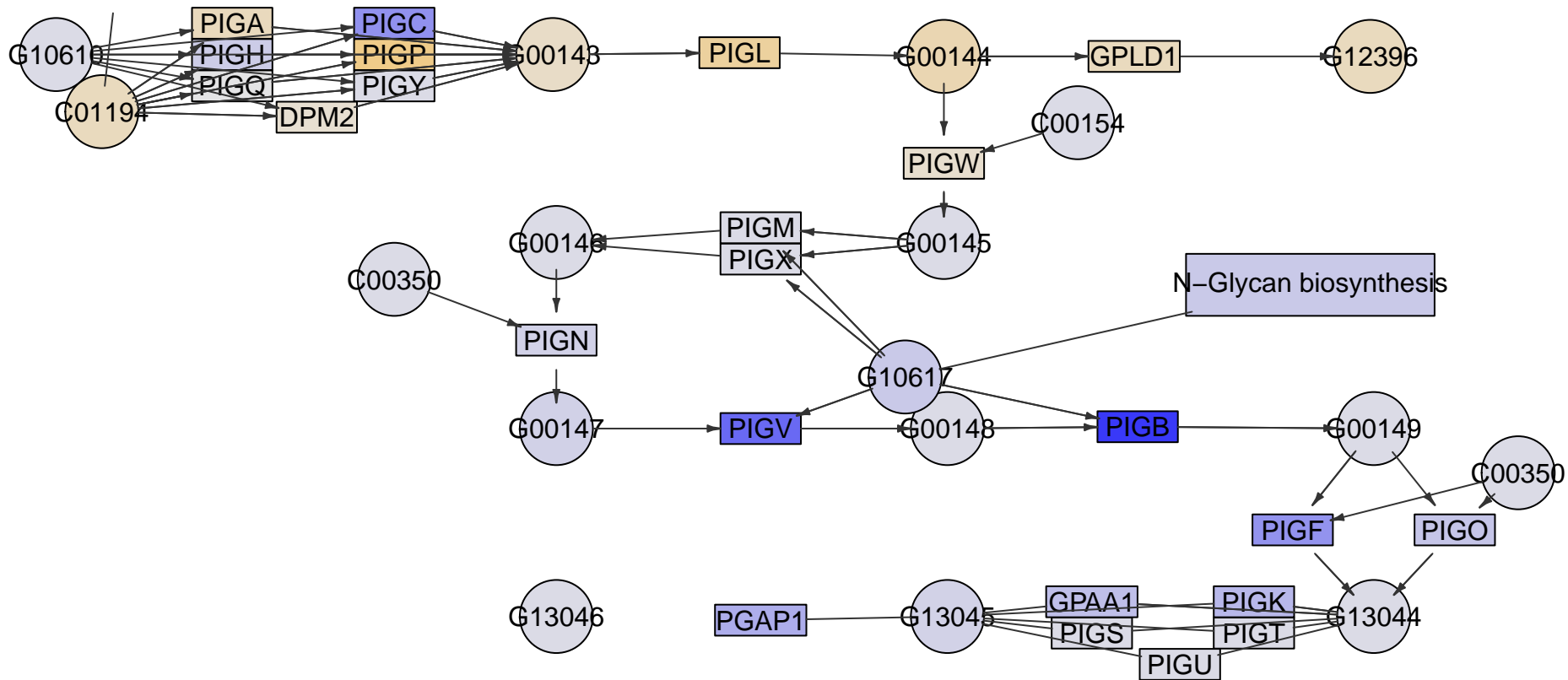

PIGK

PIGO

PIGG

PIGN

PIGZ

PIGB

PIGV

PIGM

PIGA

Glycosylphosphatidylinositol(GPI)-anchor
biosynthesis
MPI-165

Glycerophospholipid
metabolism

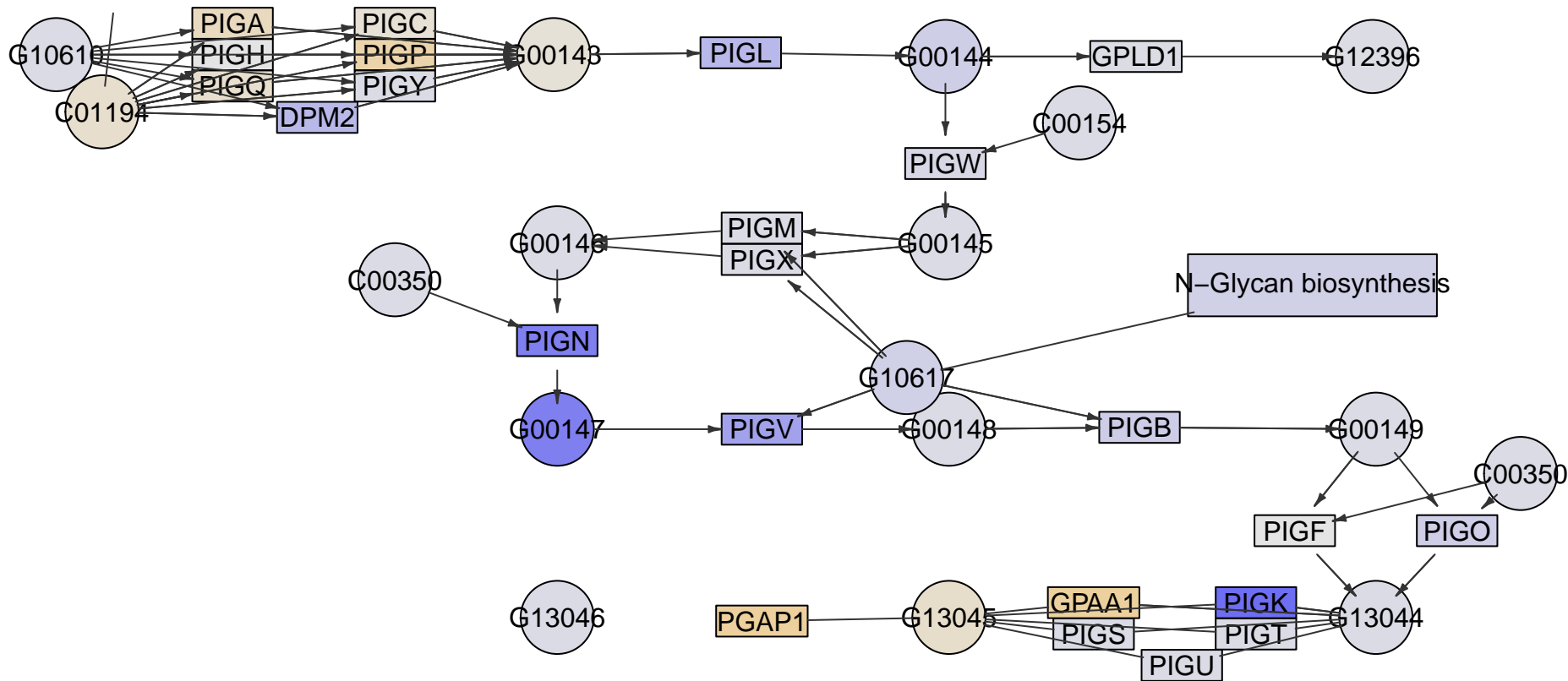

PIGK

PIGO

PIGG

PIGN

PIGZ

PIGB

PIGV

PIGM

PIGA

Glycosylphosphatidylinositol(GPI)-anchor
biosynthesis
MPI-169

Glycerophospholipid
metabolism

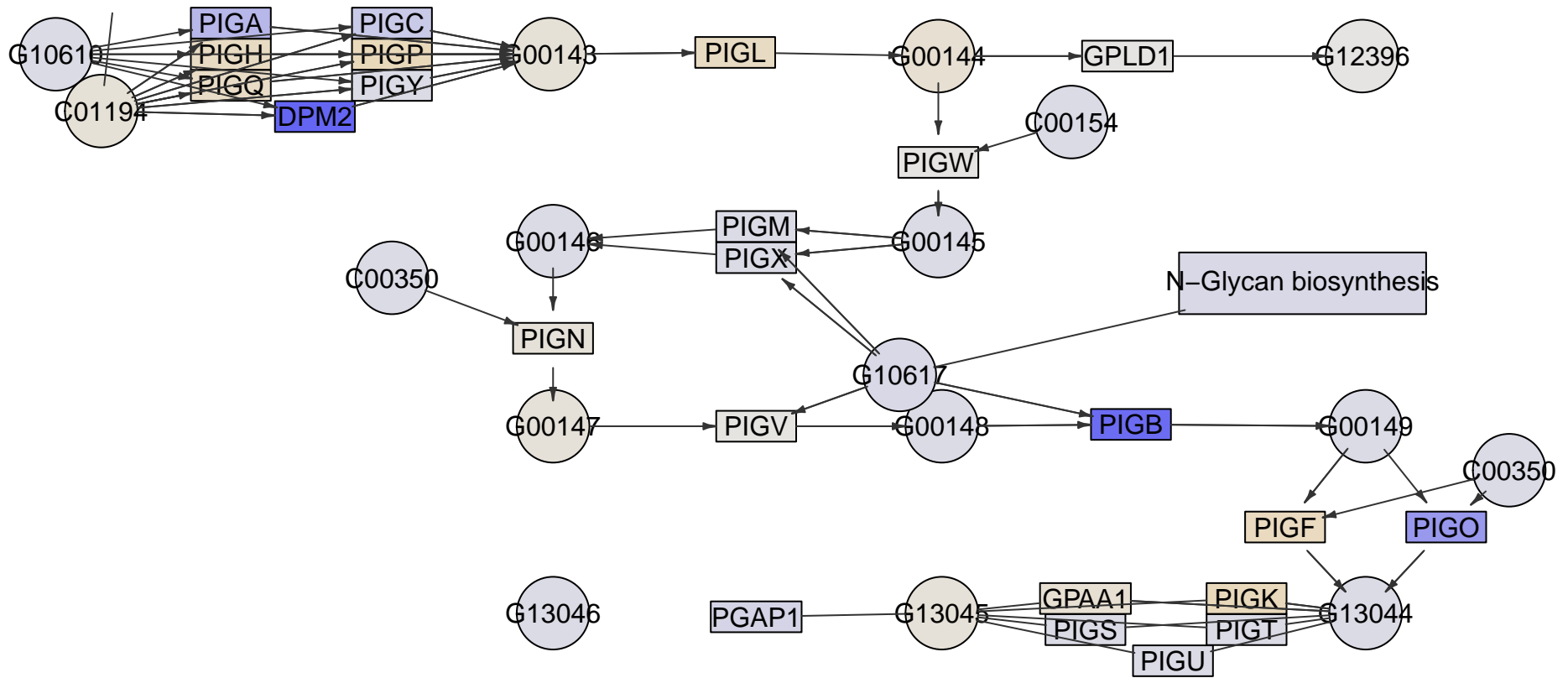

PIGK

PIGO

PIGG

PIGN

PIGZ

PIGB

PIGV

PIGM

PIGA

Glycosylphosphatidylinositol(GPI)-anchor
biosynthesis
MPI-175

Glycerophospholipid
metabolism

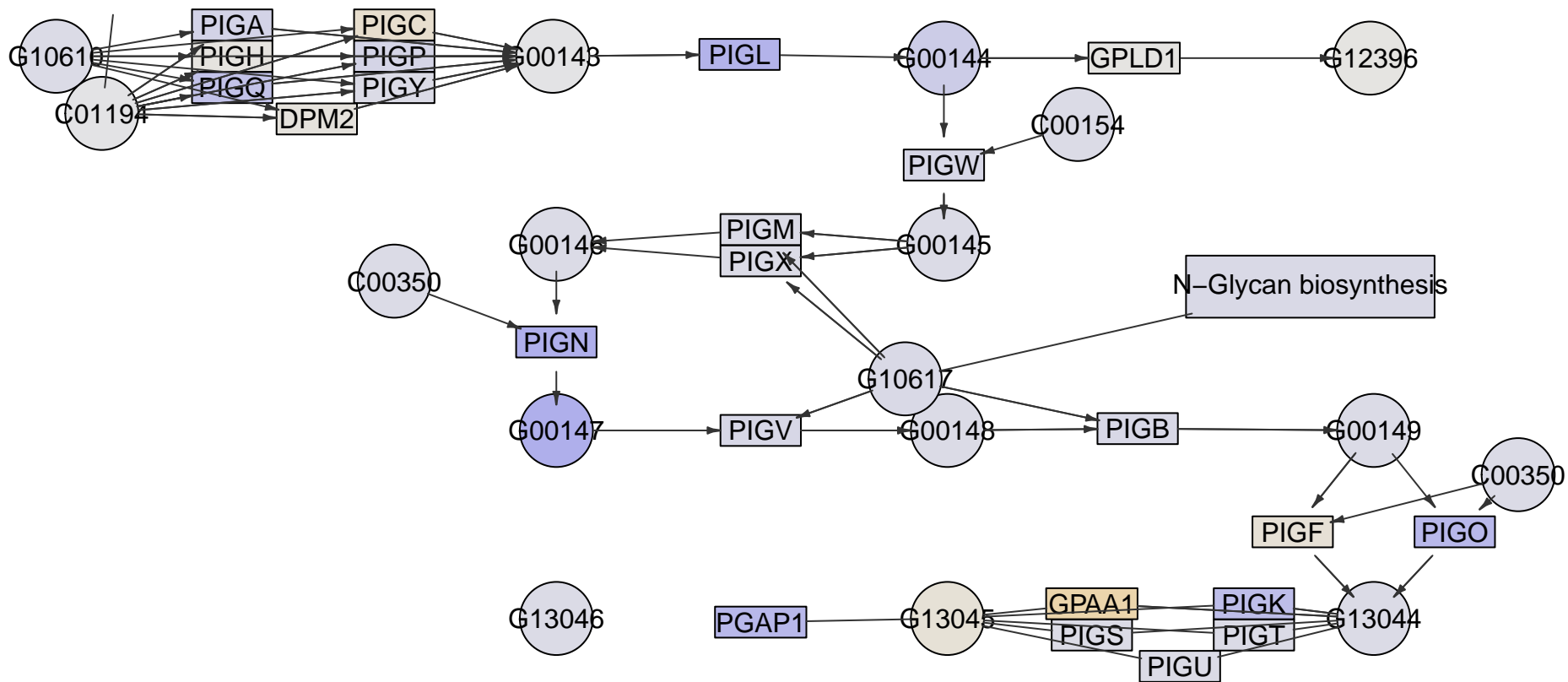

PIGK

PIGO

PIGG

PIGN

PIGZ

PIGB

PIGV

PIGM

PIGA

Glycosylphosphatidylinositol(GPI)-anchor
biosynthesis
MPI-187

Glycerophospholipid
metabolism

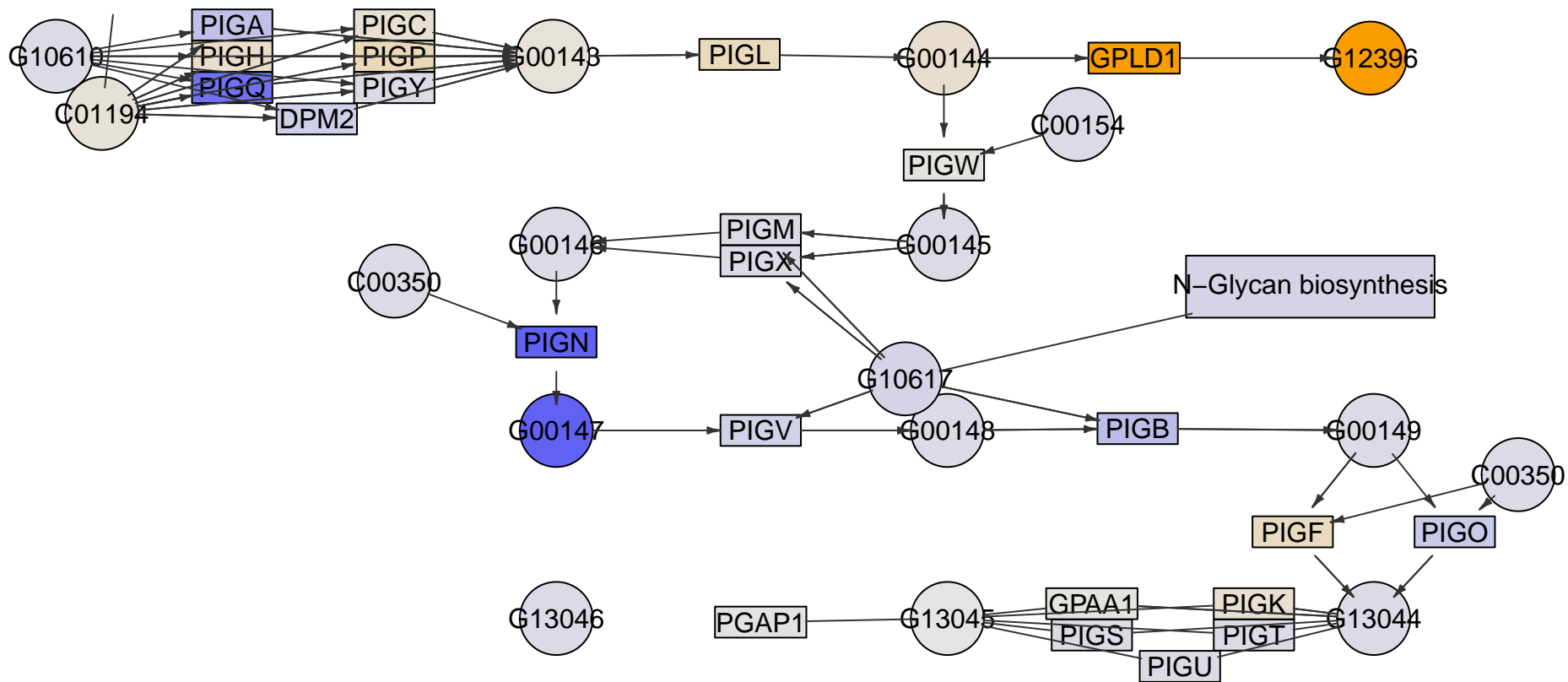

PIGK

PIGO

PIGG

PIGN

PIGZ

PIGB

PIGV

PIGM

PIGA

Glycosylphosphatidylinositol(GPI)-anchor
biosynthesis
MPI-193

Glycerophospholipid
metabolism

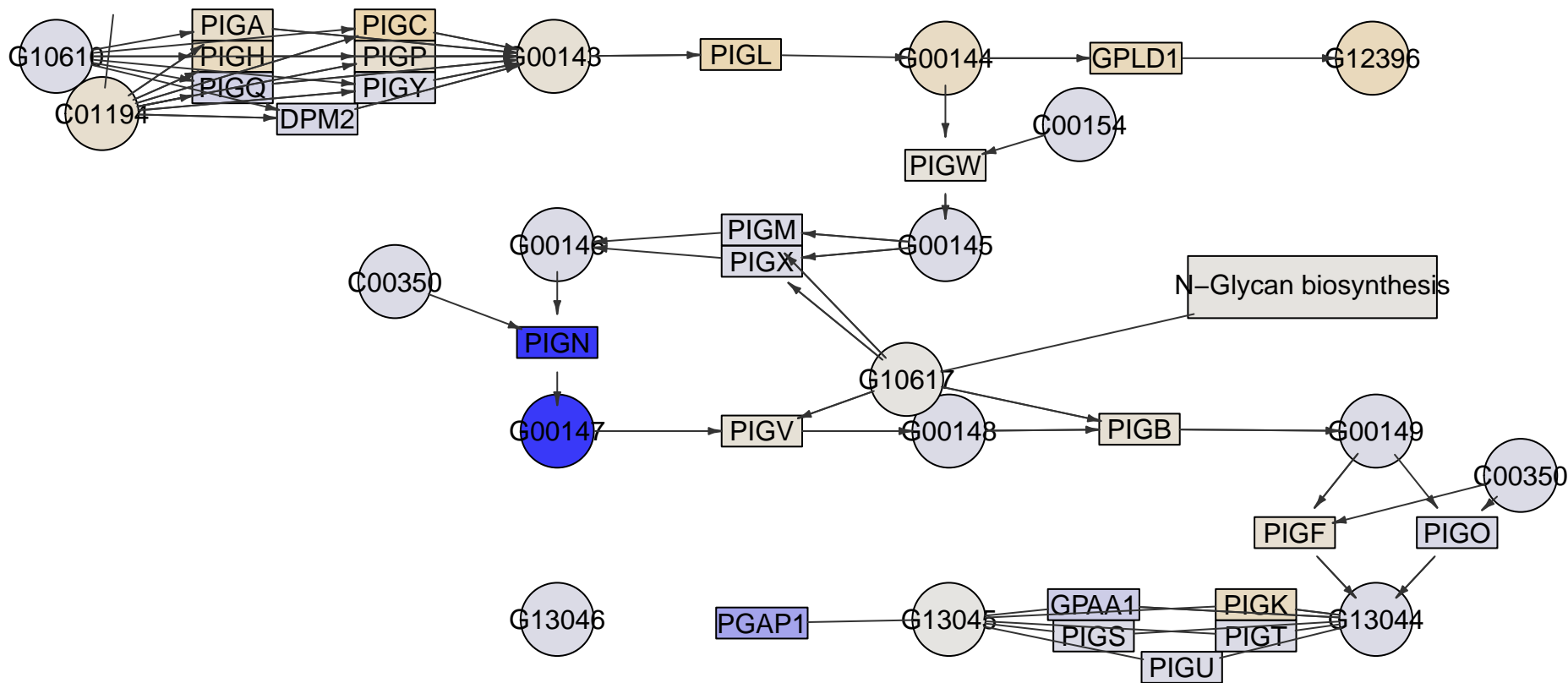

N-Glycan biosynthesis

PIGK

PIGO

PIGG

PIGN

PIGZ

PIGB

PIGV

PIGM

PIGA

Glycosylphosphatidylinositol(GPI)-anchor
biosynthesis
MPI-216

Glycerophospholipid
metabolism

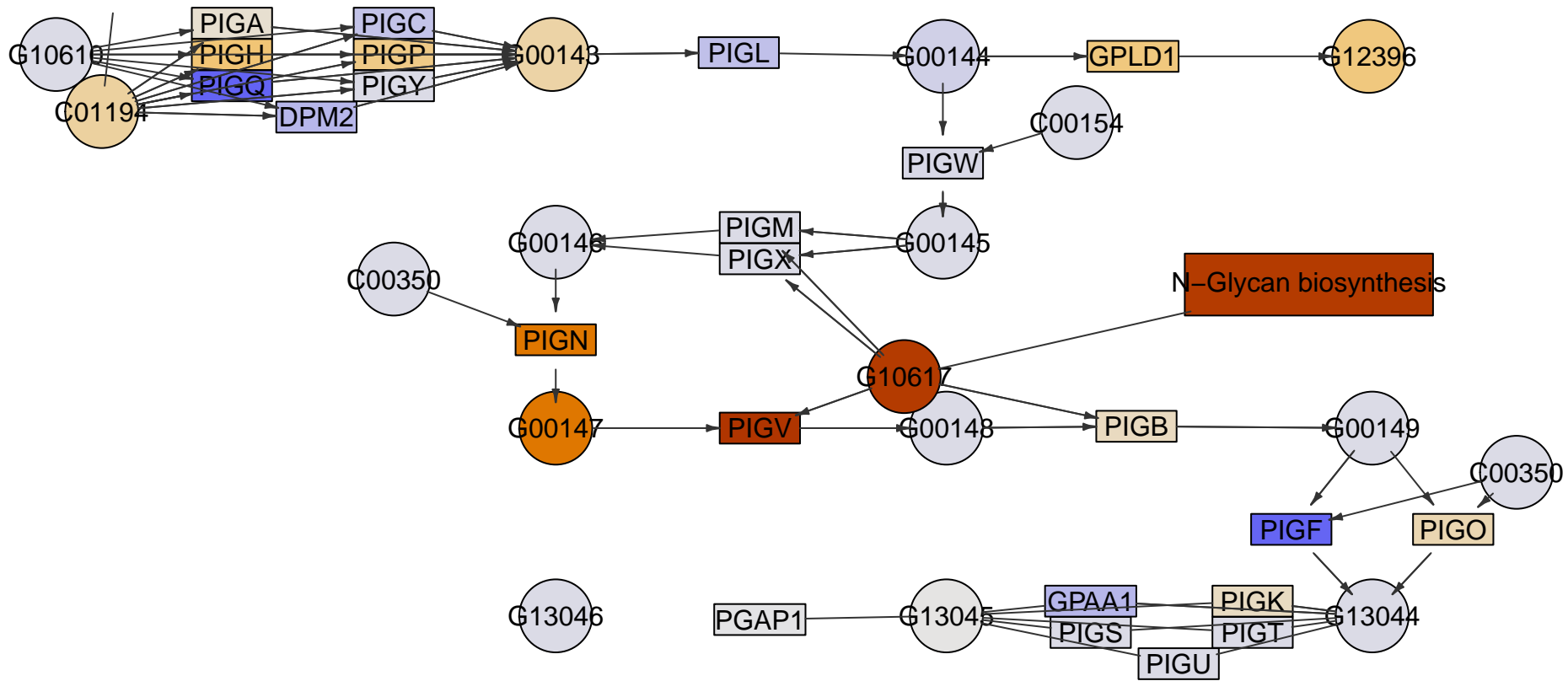

PIGK

PIGO

PIGG

PIGN

PIGZ

PIGB

PIGV

PIGM

PIGA

Glycosylphosphatidylinositol(GPI)-anchor
biosynthesis
MPI-222

Glycerophospholipid
metabolism

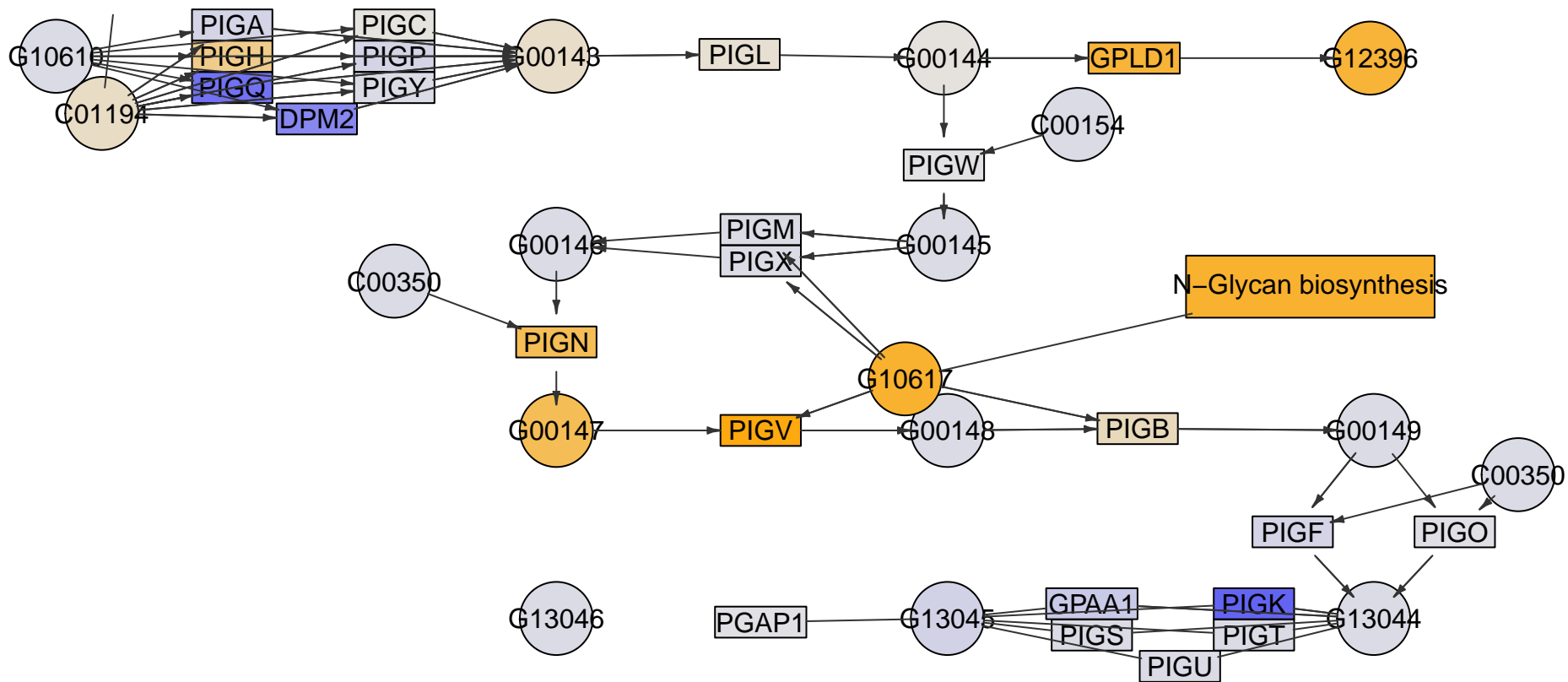

PIGK

PIGO

PIGG

PIGN

PIGZ

PIGB

PIGV

PIGM

PIGA

Glycosylphosphatidylinositol(GPI)-anchor
biosynthesis
MPI-225

Glycerophospholipid
metabolism

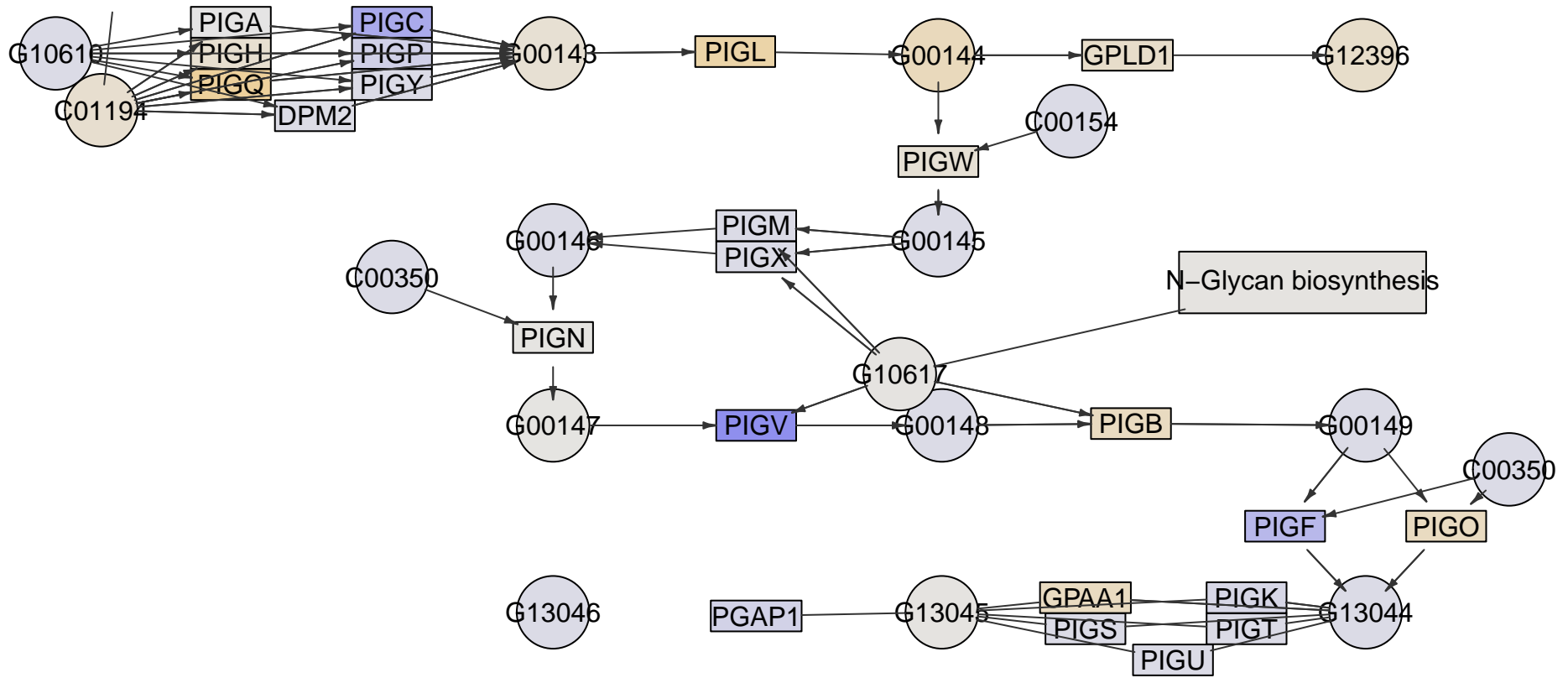

PIGK

PIGO

PIGG

PIGN

PIGZ

PIGB

PIGV

PIGM

PIGA

Glycosylphosphatidylinositol(GPI)-anchor
biosynthesis
MPI-242

Glycerophospholipid
metabolism

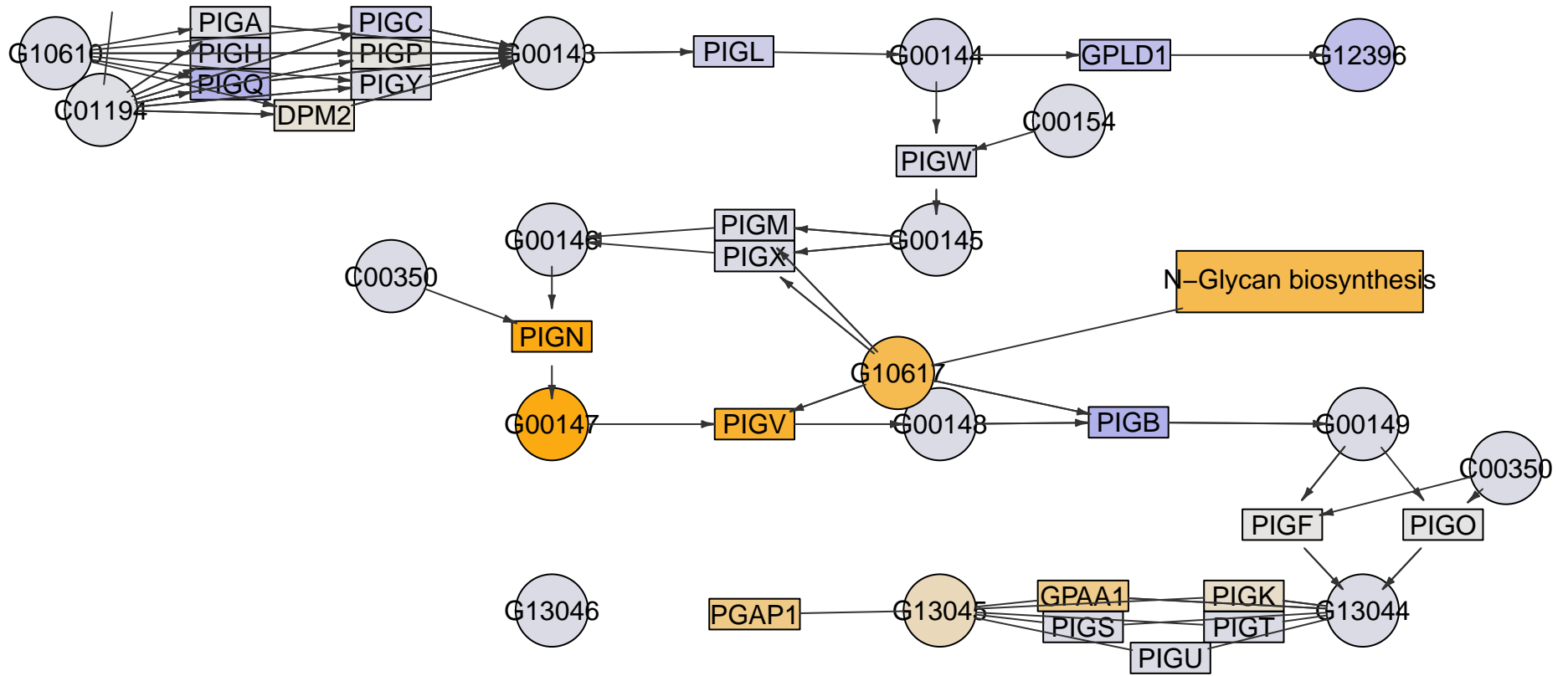

PIGK

PIGO

PIGG

PIGN

PIGZ

PIGB

PIGV

PIGM

PIGA

Glycosylphosphatidylinositol(GPI)-anchor
biosynthesis
MPI-245

Glycerophospholipid
metabolism

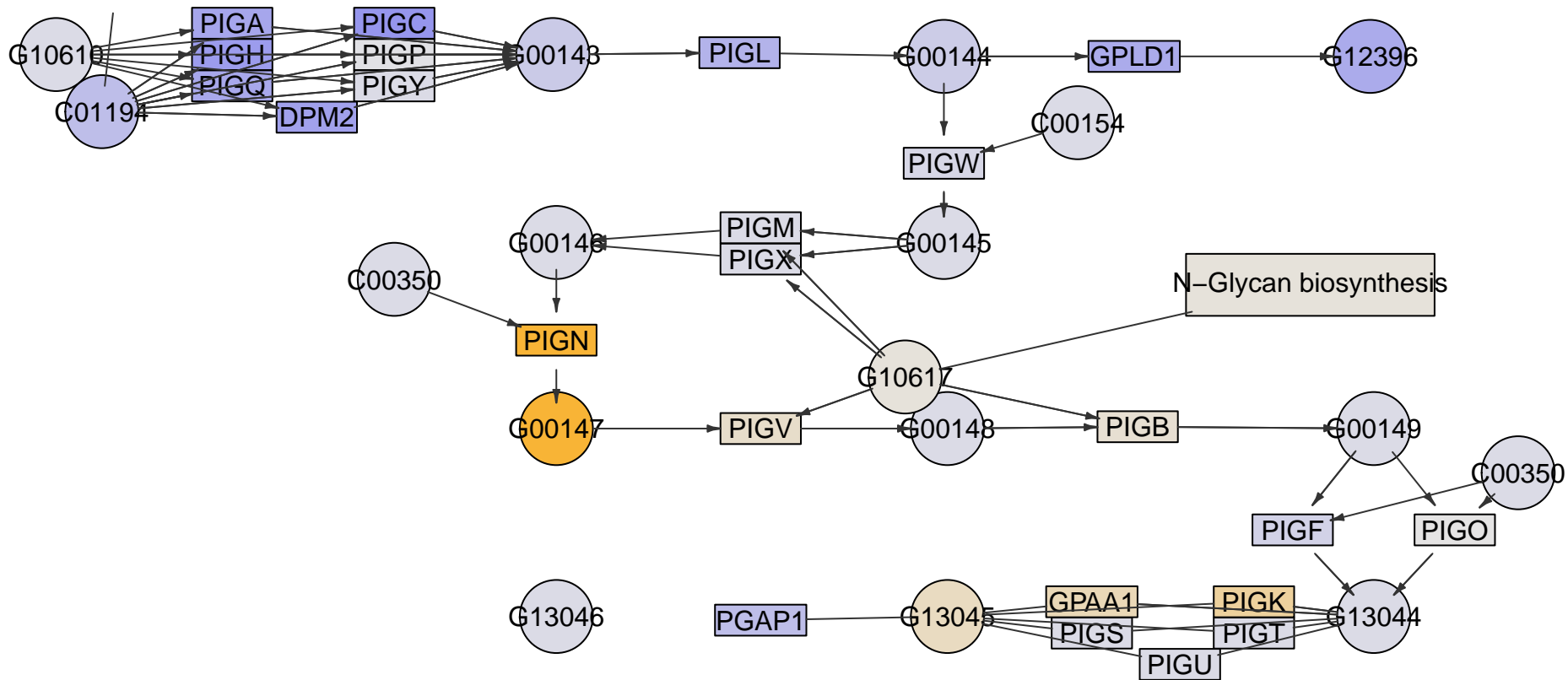

N-Glycan biosynthesis

PIGK

PIGO

PIGG

PIGN

PIGZ

PIGB

PIGV

PIGM

PIGA

Glycosylphosphatidylinositol(GPI)-anchor
biosynthesis
MPI-248

Glycerophospholipid
metabolism

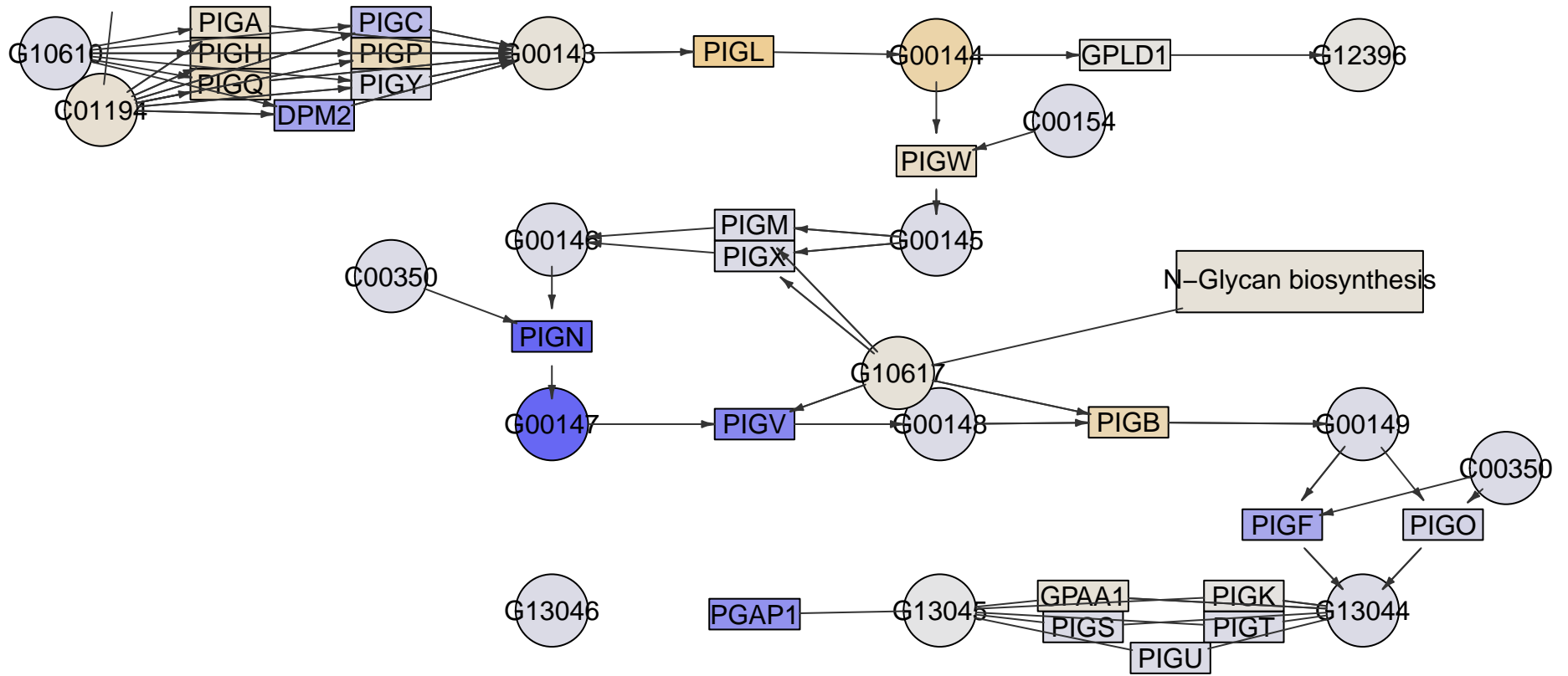

PIGK

PIGO

PIGG

PIGN

PIGZ

PIGB

PIGV

PIGM

PIGA

Glycosylphosphatidylinositol(GPI)-anchor
biosynthesis
MPI-249

Glycerophospholipid
metabolism

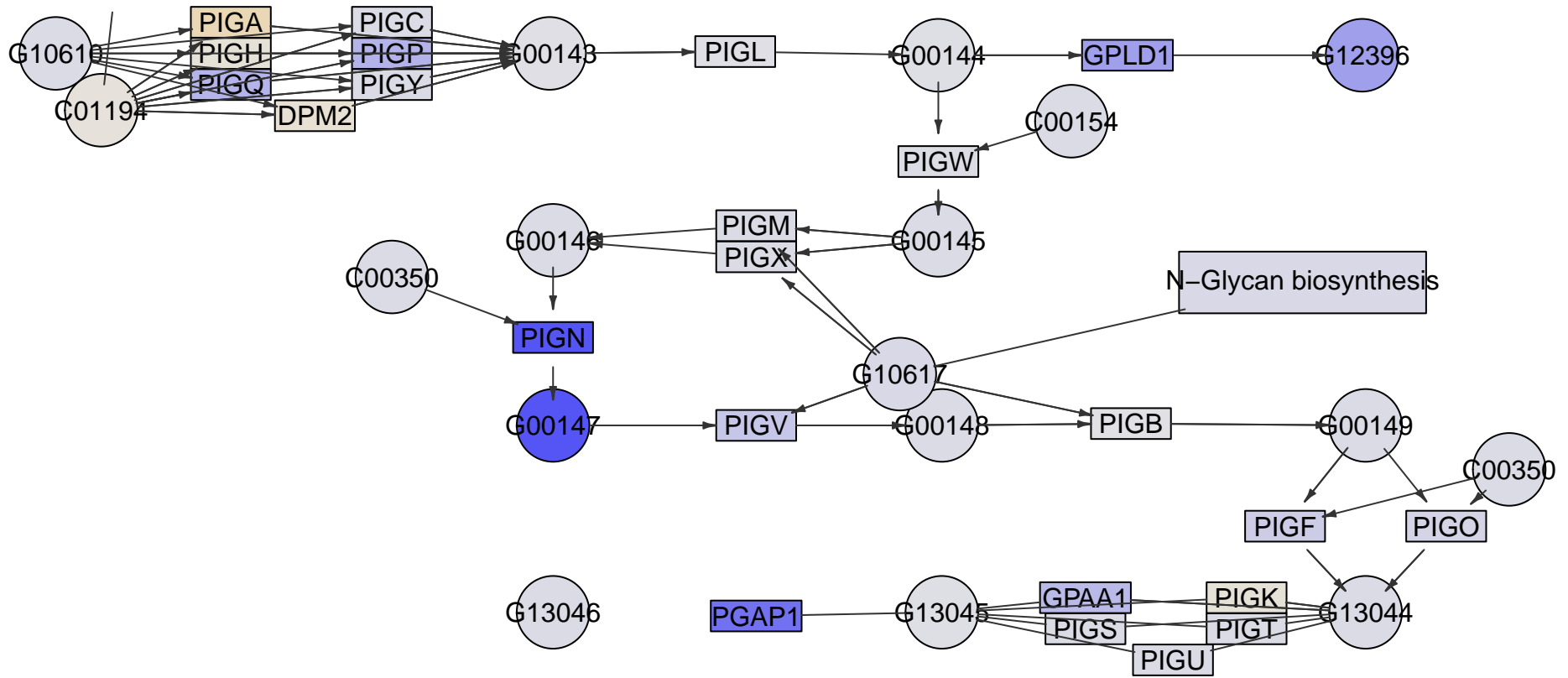

PIGK

PIGO

PIGG

PIGN

PIGZ

PIGB

PIGV

PIGM

PIGA

N-Glycan biosynthesis

Glycosylphosphatidylinositol(GPI)-anchor
biosynthesis
MPI-250

Glycerophospholipid
metabolism

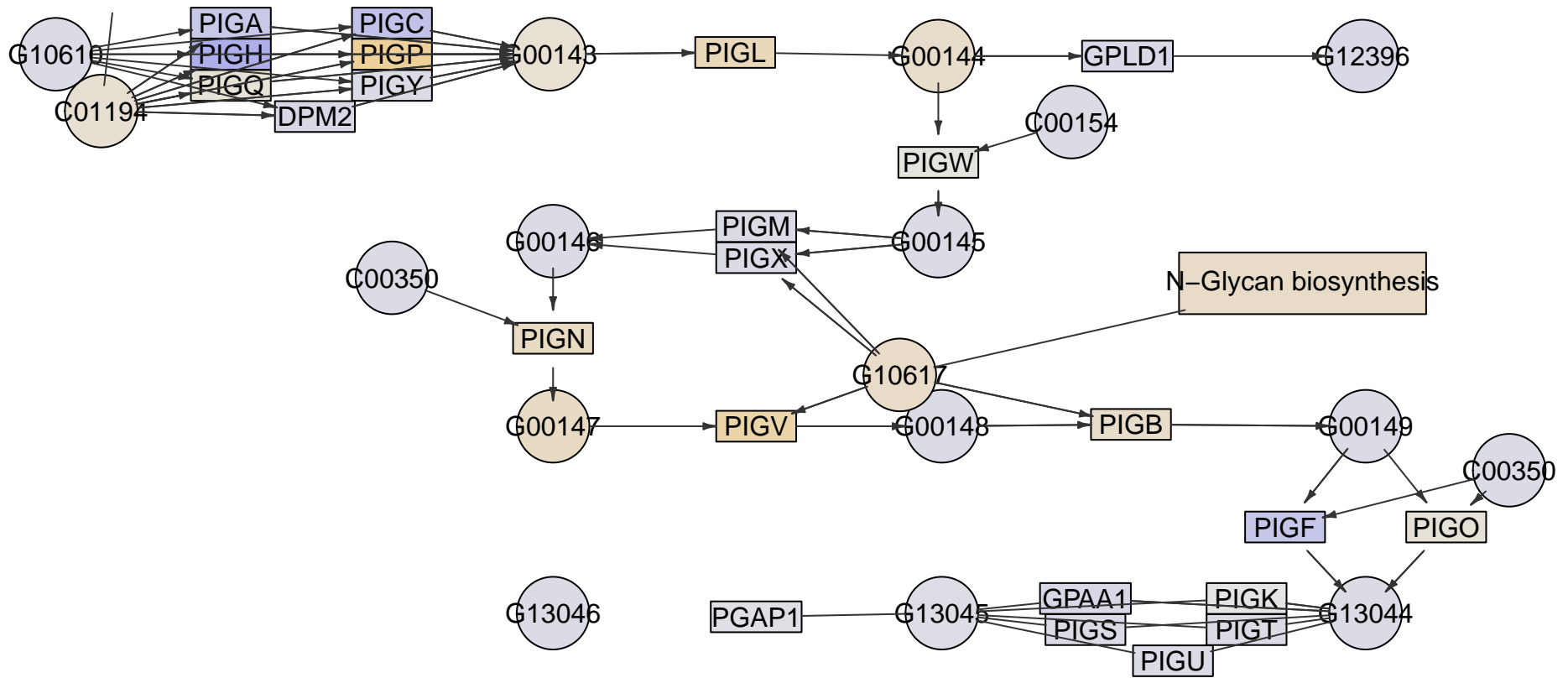

PIGK

PIGO

PIGG

PIGN

PIGZ

PIGB

PIGV

PIGM

PIGA

Glycosylphosphatidylinositol(GPI)-anchor
biosynthesis
MPI-008

Glycerophospholipid
metabolism

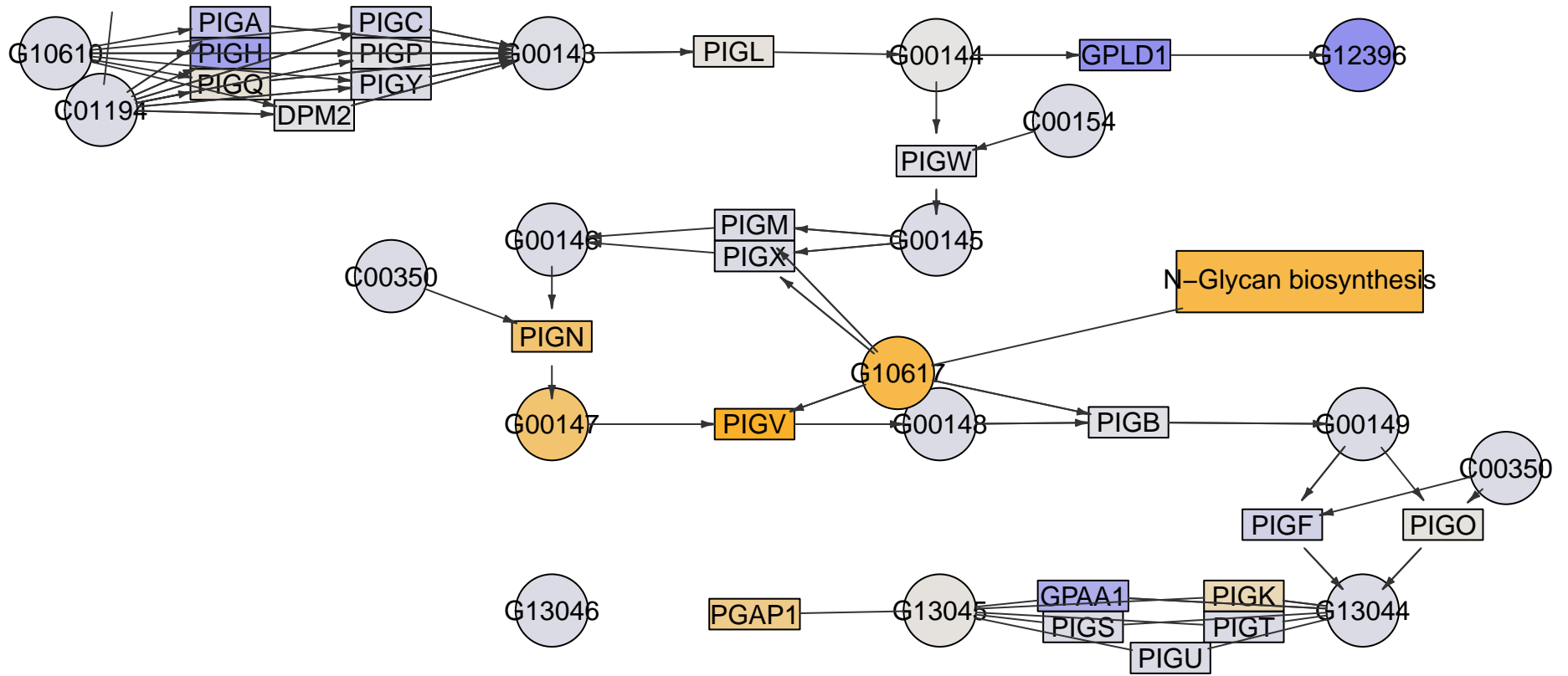

PIGK

PIGO

PIGG

PIGN

PIGZ

PIGB

PIGV

PIGM

PIGA

N-Glycan biosynthesis

Glycosylphosphatidylinositol(GPI)-anchor
biosynthesis
MPI-009

Glycerophospholipid
metabolism

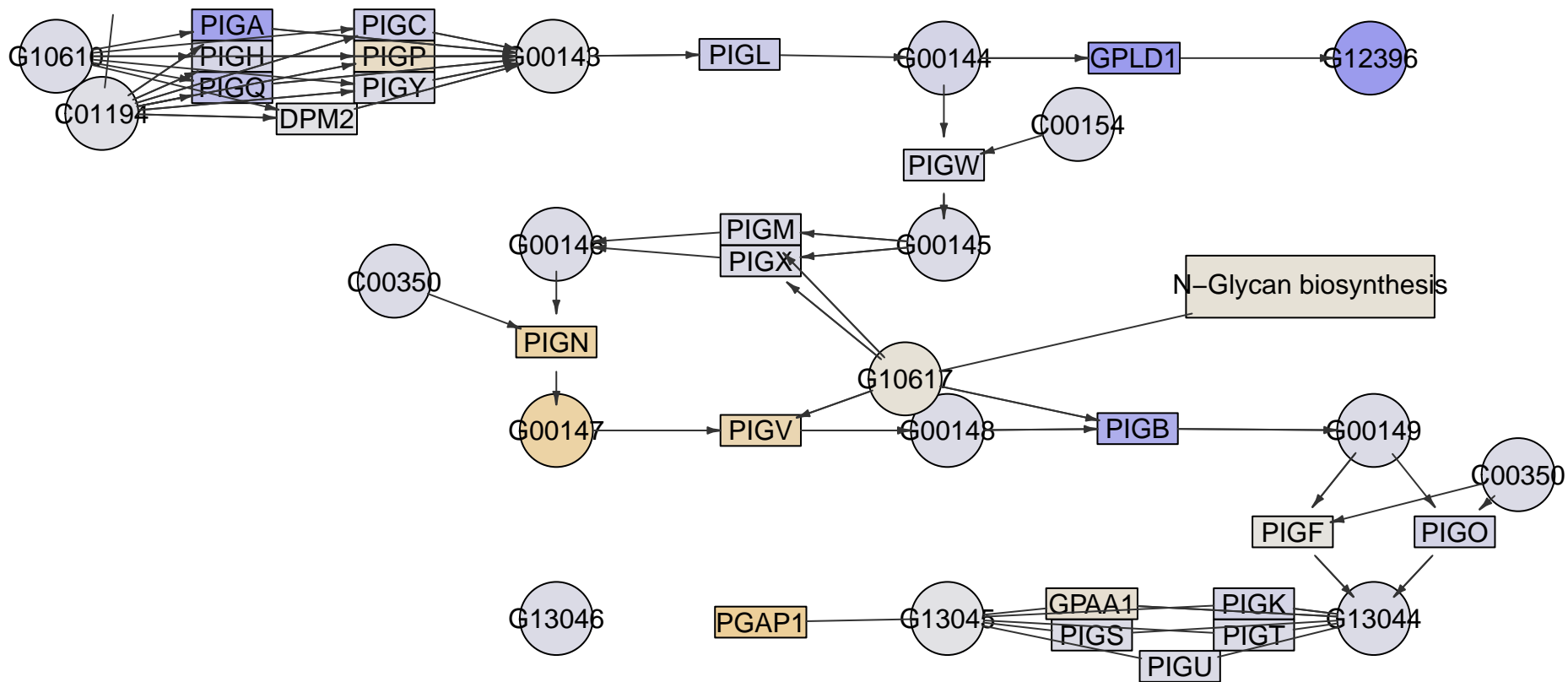

PIGK

PIGO

PIGG

PIGN

PIGZ

PIGB

PIGV

PIGM

PIGA

Glycosylphosphatidylinositol(GPI)-anchor
biosynthesis
MPI-010

Glycerophospholipid
metabolism

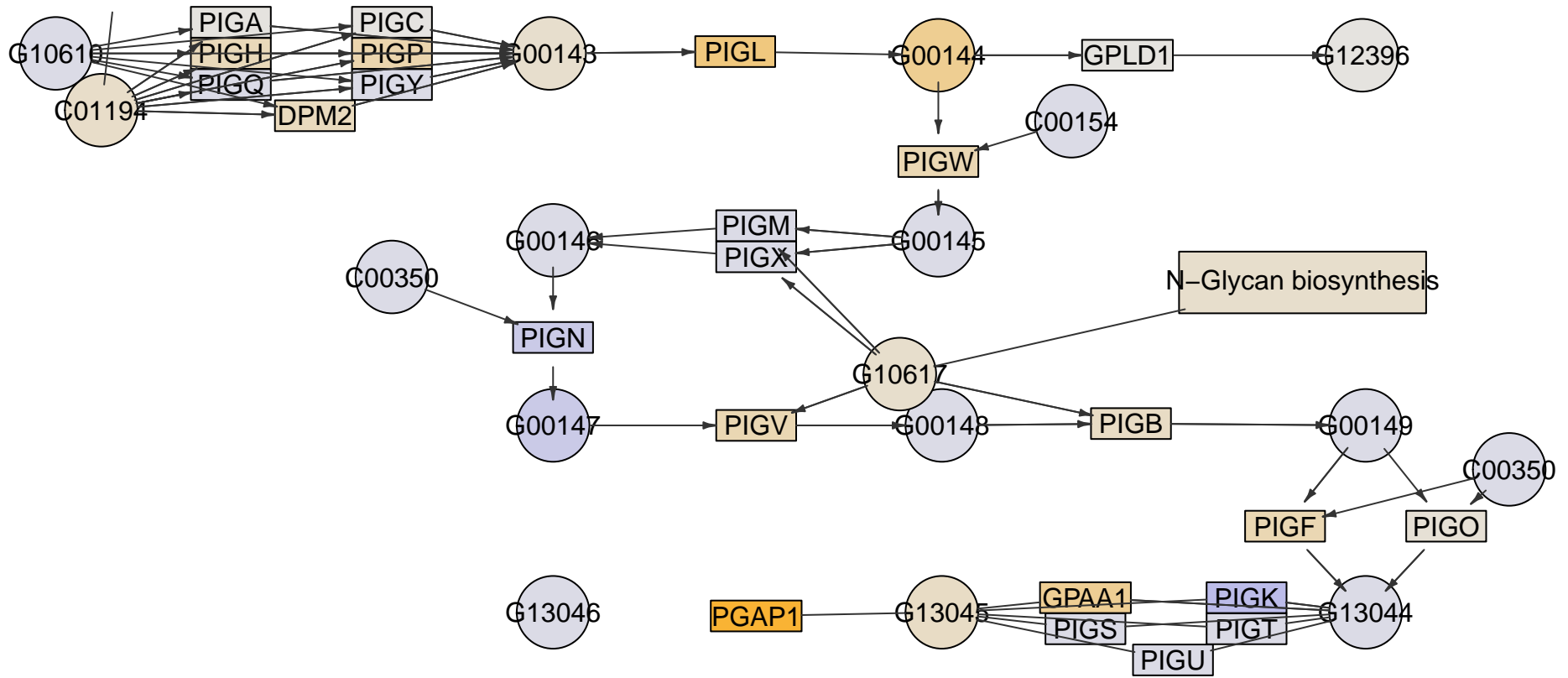

PIGK

PIGO

PIGG

PIGN

PIGZ

PIGB

PIGV

PIGM

PIGA

Glycosylphosphatidylinositol(GPI)-anchor
biosynthesis
MPI-012

Glycerophospholipid
metabolism

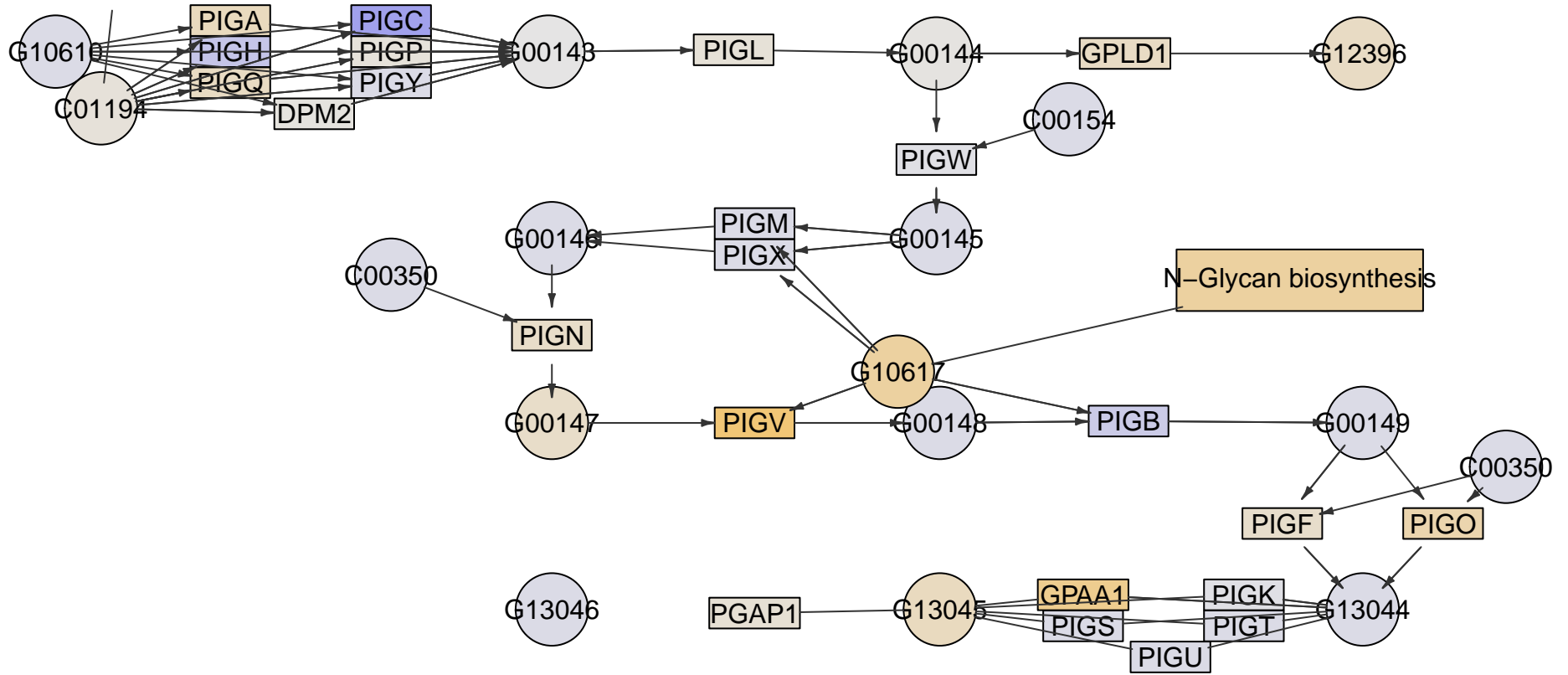

PIGK

PIGO

PIGG

PIGN

PIGZ

PIGB

PIGV

PIGM

PIGA

Glycosylphosphatidylinositol(GPI)-anchor
biosynthesis
MPI-013

Glycerophospholipid
metabolism

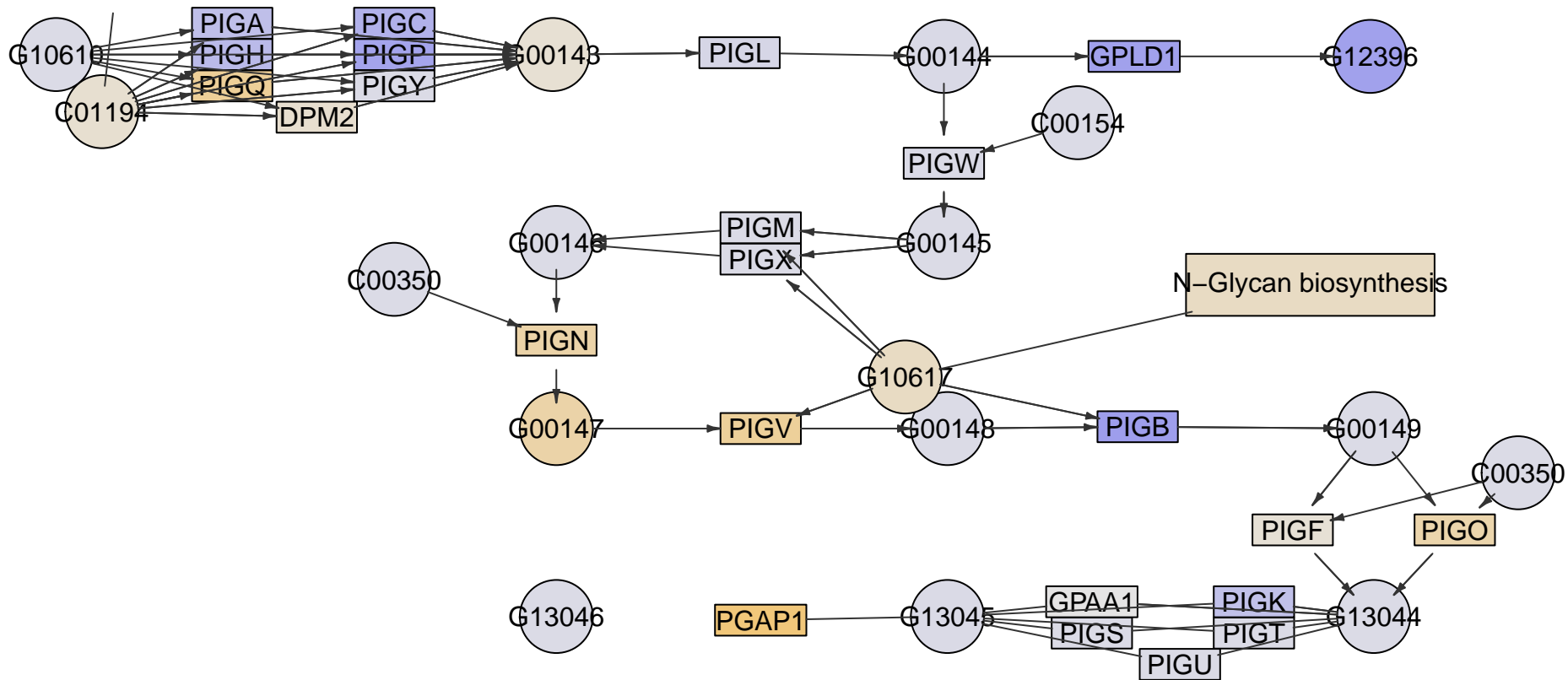

PIGK

PIGO

PIGG

PIGN

PIGZ

PIGB

PIGV

PIGM

PIGA

Glycosylphosphatidylinositol(GPI)-anchor
biosynthesis
MPI-014

Glycerophospholipid
metabolism

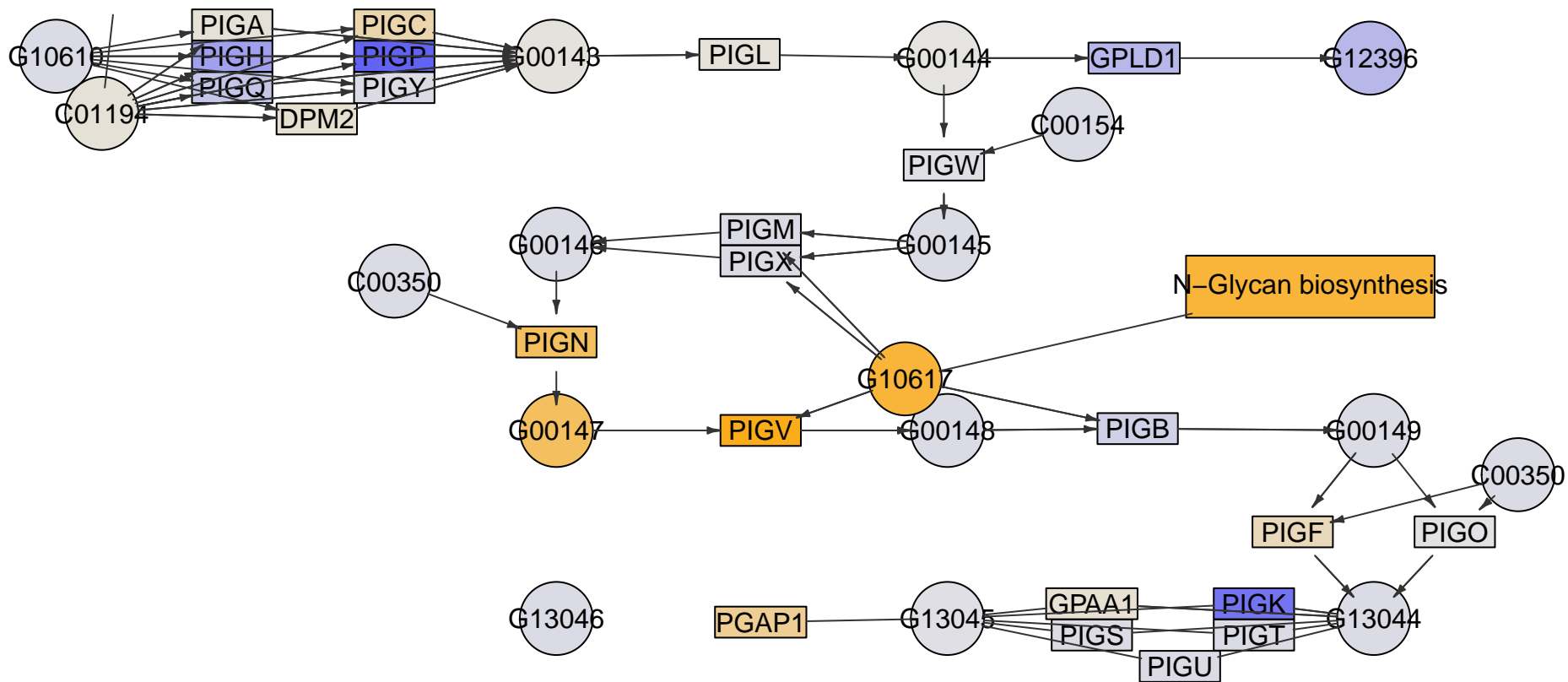

PIGK

PIGO

PIGG

PIGN

PIGZ

PIGB

PIGV

PIGM

PIGA

Glycosylphosphatidylinositol(GPI)-anchor
biosynthesis
MPI-015

Glycerophospholipid
metabolism

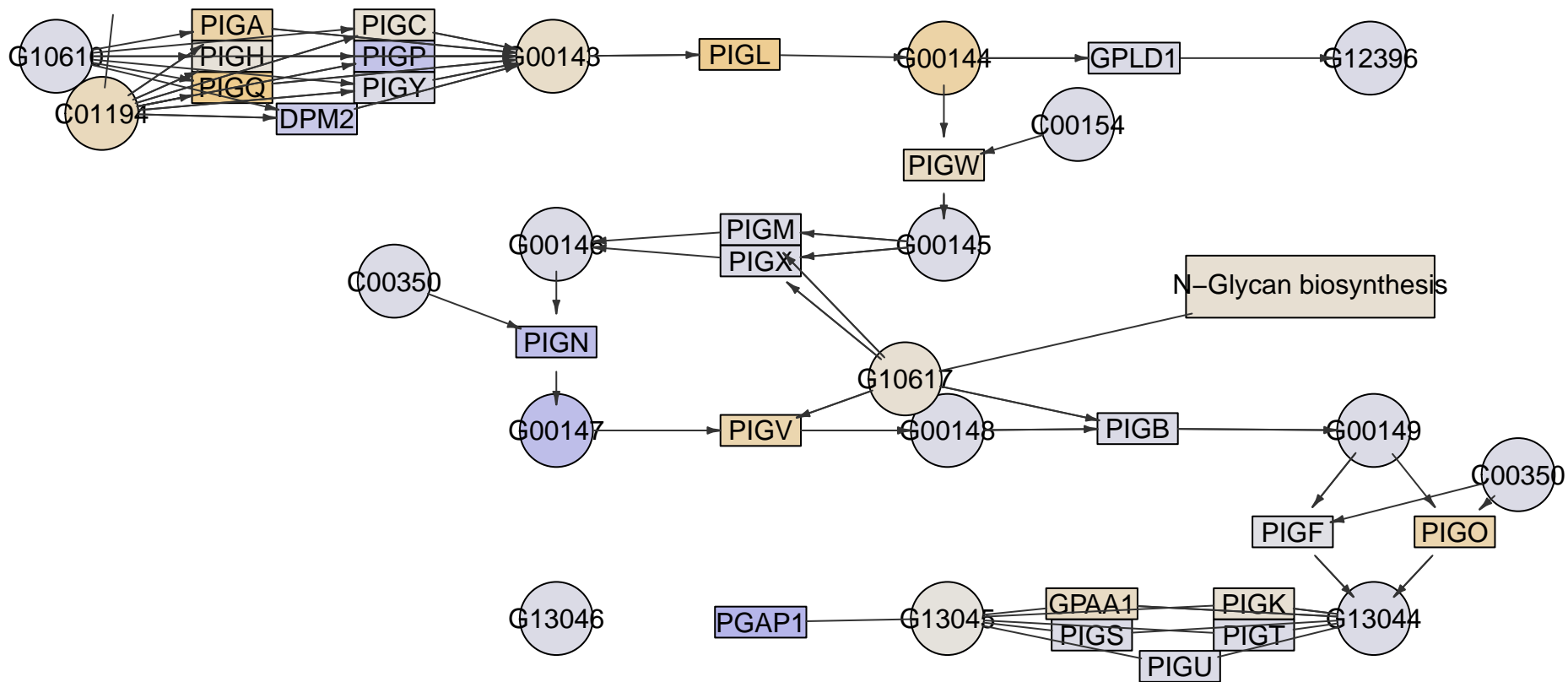

N-Glycan biosynthesis

PIGK

PIGO

PIGG

PIGN

PIGZ

PIGB

PIGV

PIGM

PIGA

Glycosylphosphatidylinositol(GPI)-anchor
biosynthesis
MPI-021

Glycerophospholipid
metabolism

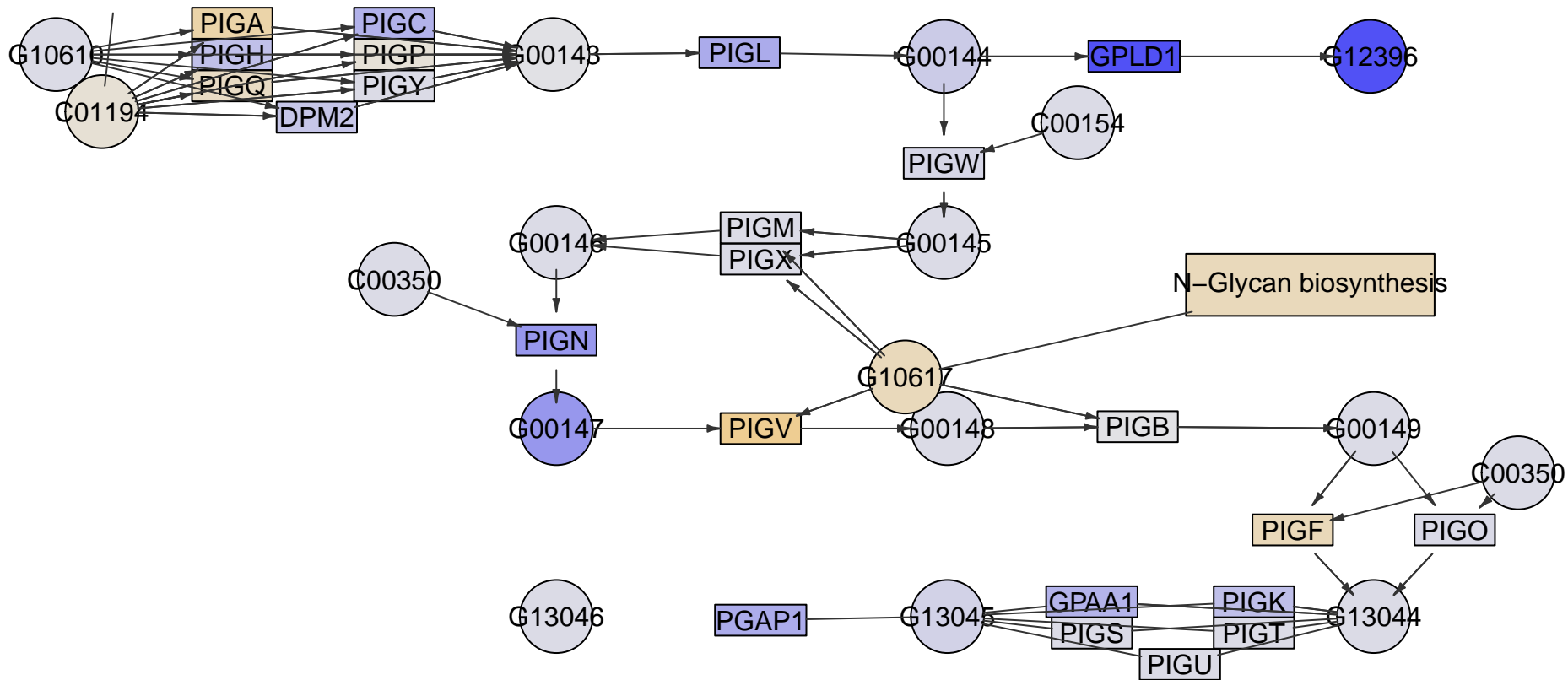

PIGK

PIGO

PIGG

PIGN

PIGZ

PIGB

PIGV

PIGM

PIGA

Glycosylphosphatidylinositol(GPI)-anchor
biosynthesis
MPI-022

Glycerophospholipid
metabolism

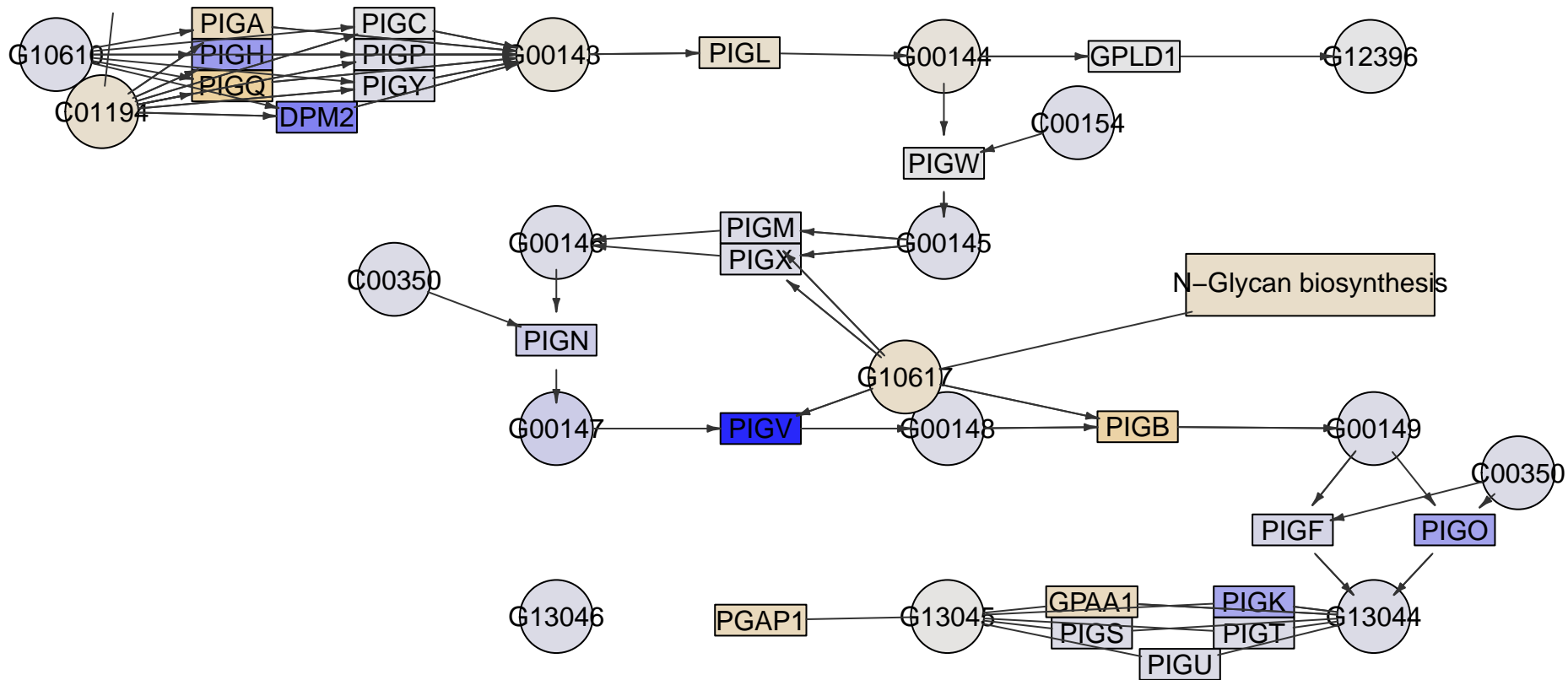

PIGK

PIGO

PIGG

PIGN

PIGZ

PIGB

PIGV

PIGM

PIGA

Glycosylphosphatidylinositol(GPI)-anchor
biosynthesis
MPI-025

Glycerophospholipid
metabolism

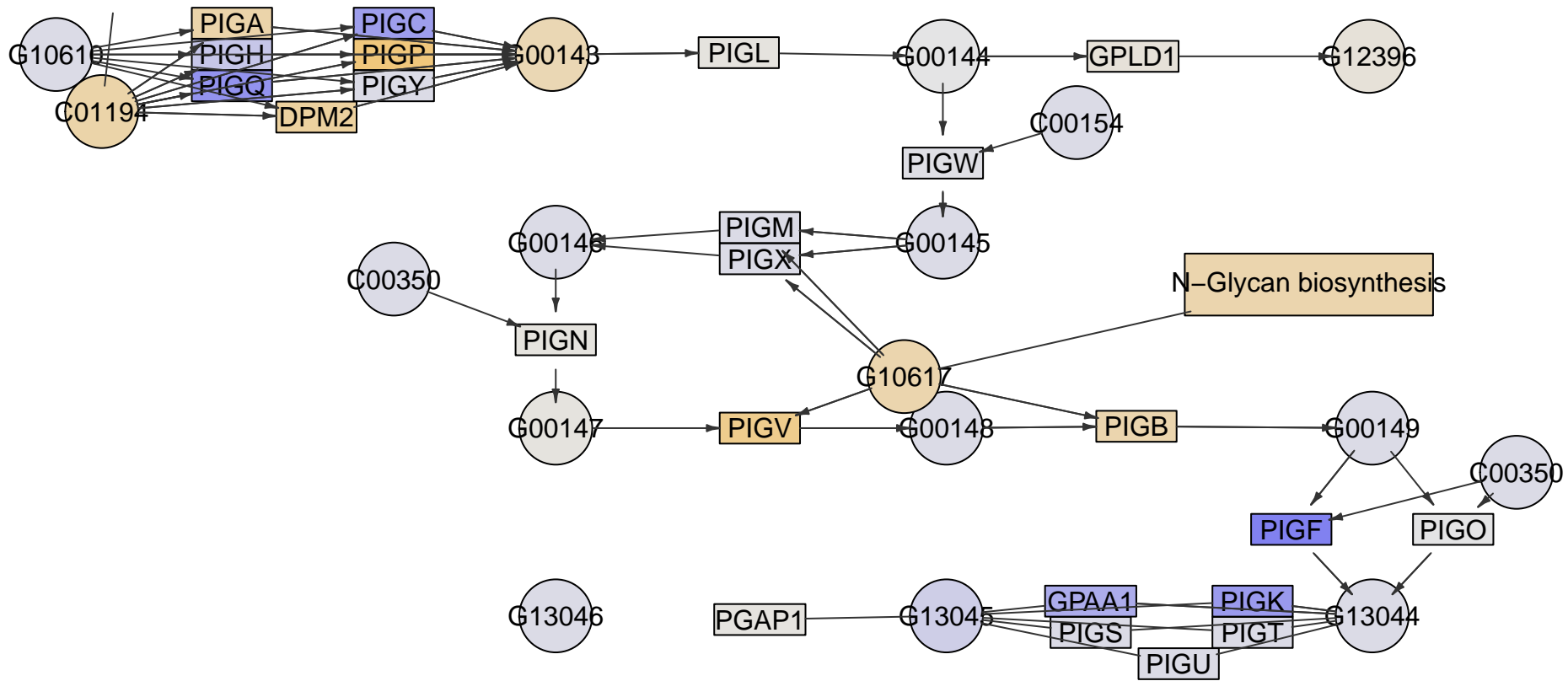

PIGK

PIGO

PIGG

PIGN

PIGZ

PIGB

PIGV

PIGM

PIGA

Glycosylphosphatidylinositol(GPI)-anchor
biosynthesis
MPI-029

Glycerophospholipid
metabolism

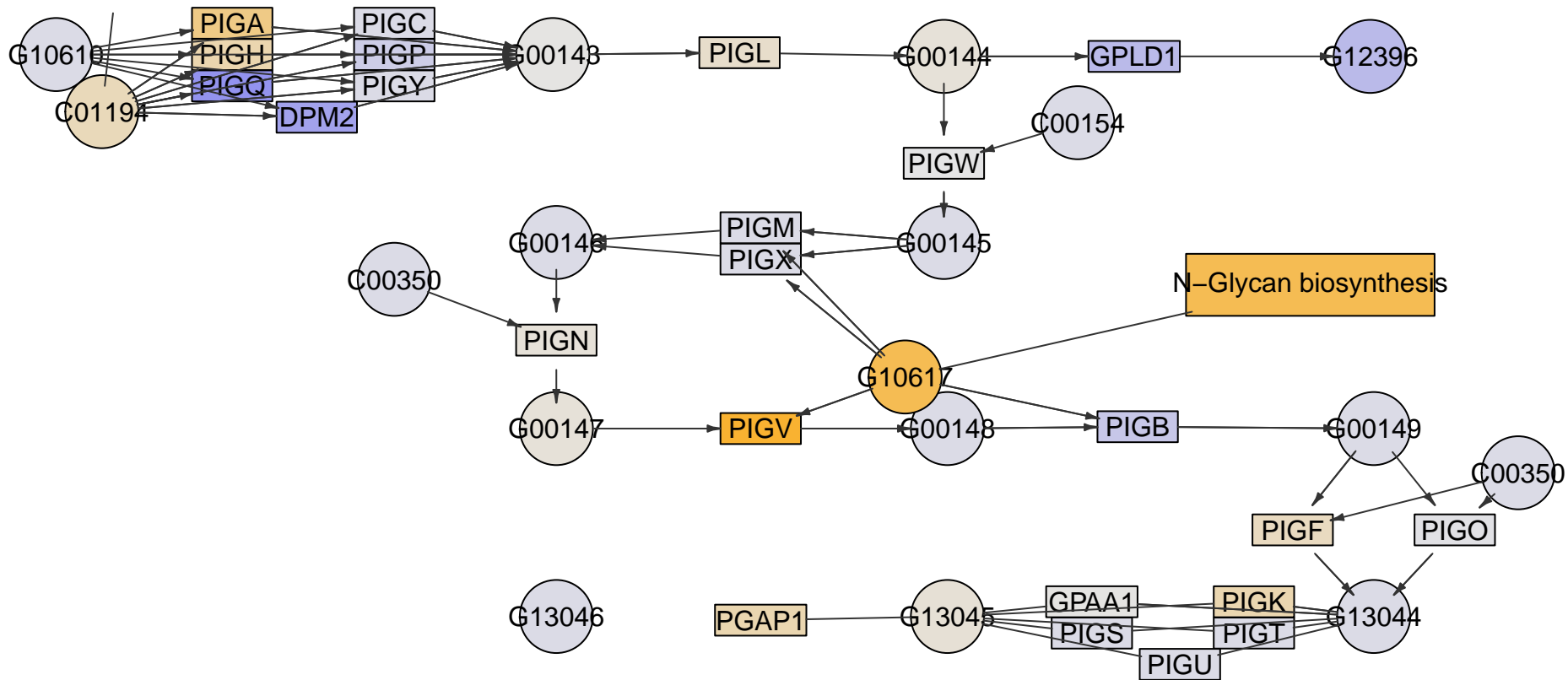

N-Glycan biosynthesis

PIGK

PIGO

PIGG

PIGN

PIGZ

PIGB

PIGV

PIGM

PIGA

Glycosylphosphatidylinositol(GPI)-anchor
biosynthesis
MPI-030

Glycerophospholipid
metabolism

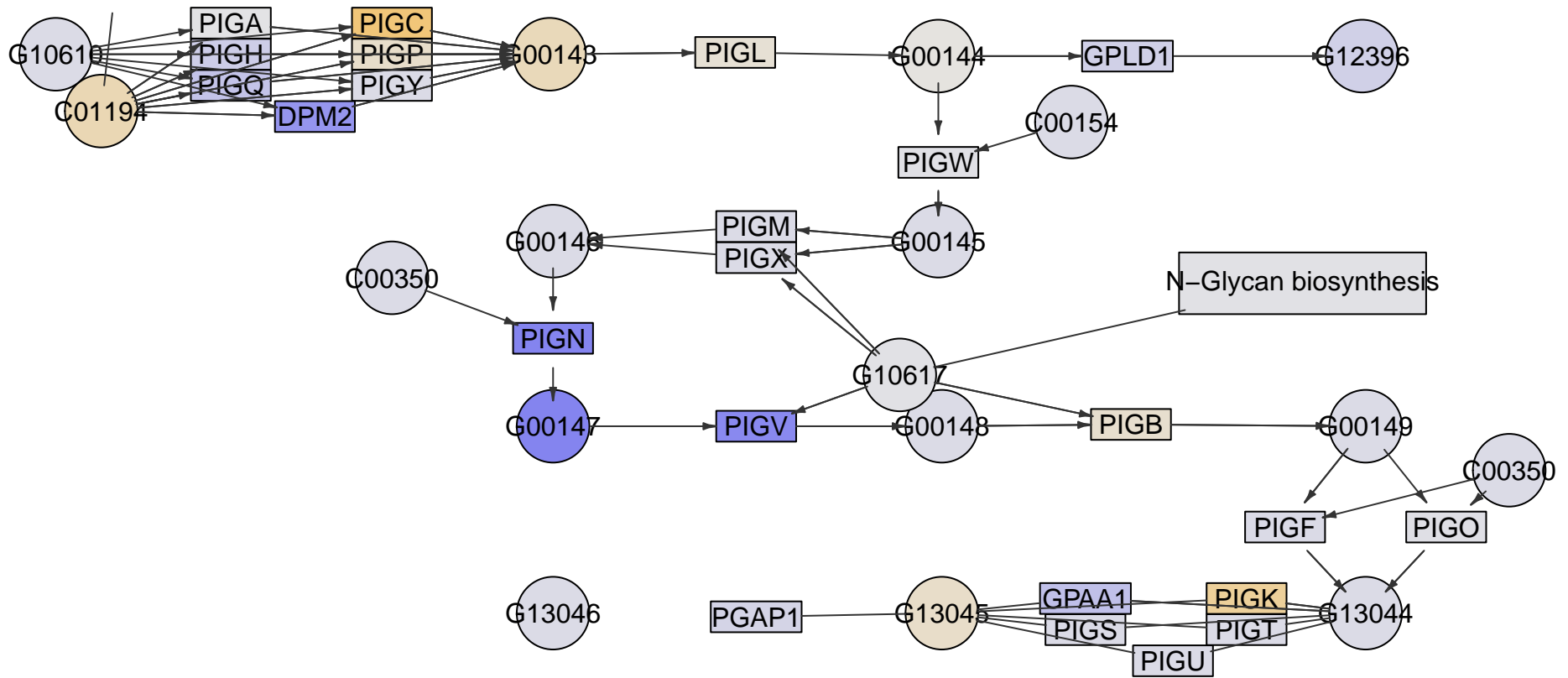

PIGK

PIGO

PIGG

PIGN

PIGZ

PIGB

PIGV

PIGM

PIGA

Glycosylphosphatidylinositol(GPI)-anchor
biosynthesis
MPI-031

Glycerophospholipid
metabolism

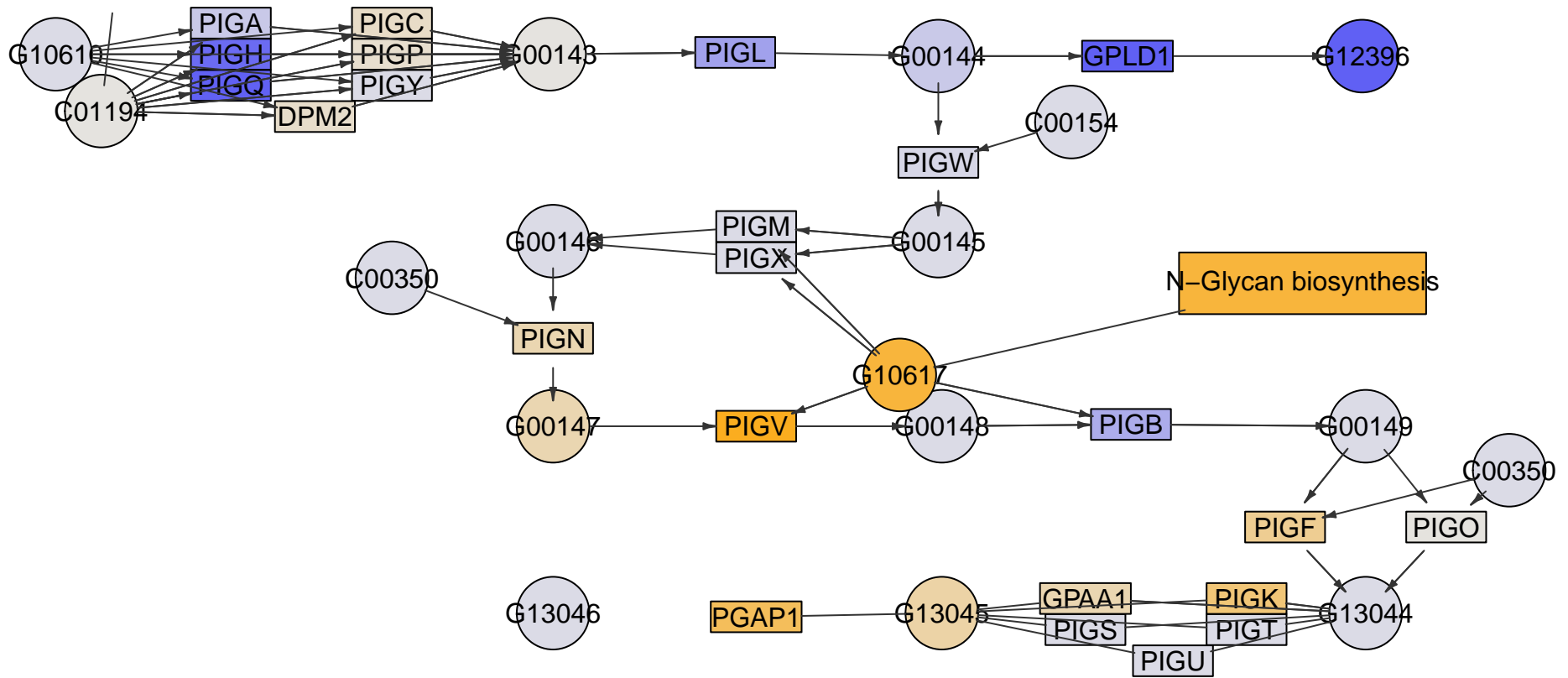

PIGK

PIGO

PIGG

PIGN

PIGZ

PIGB

PIGV

PIGM

PIGA

Glycosylphosphatidylinositol(GPI)-anchor
biosynthesis
MPI-039

Glycerophospholipid
metabolism

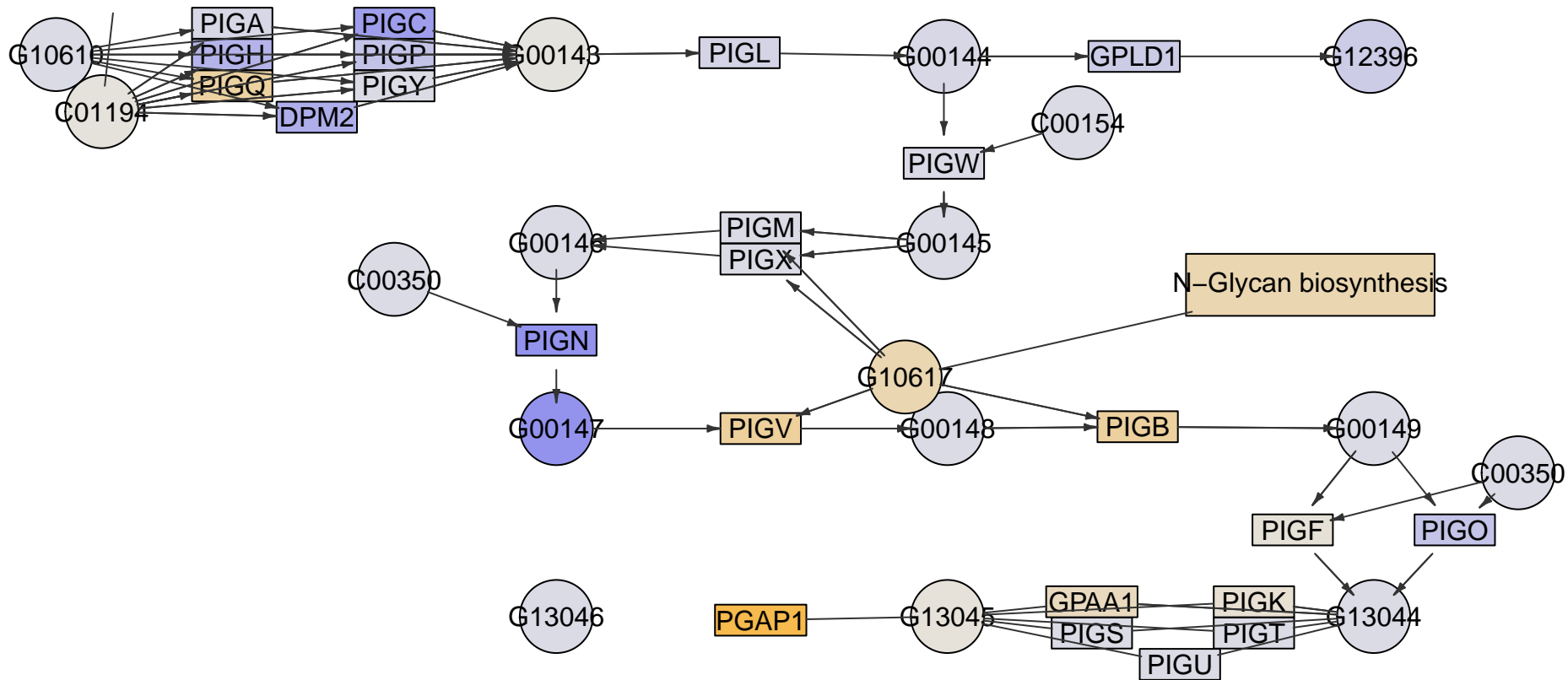

PIGK

PIGO

PIGG

PIGN

PIGZ

PIGB

PIGV

PIGM

PIGA

Glycosylphosphatidylinositol(GPI)-anchor
biosynthesis
MPI-040

Glycerophospholipid
metabolism

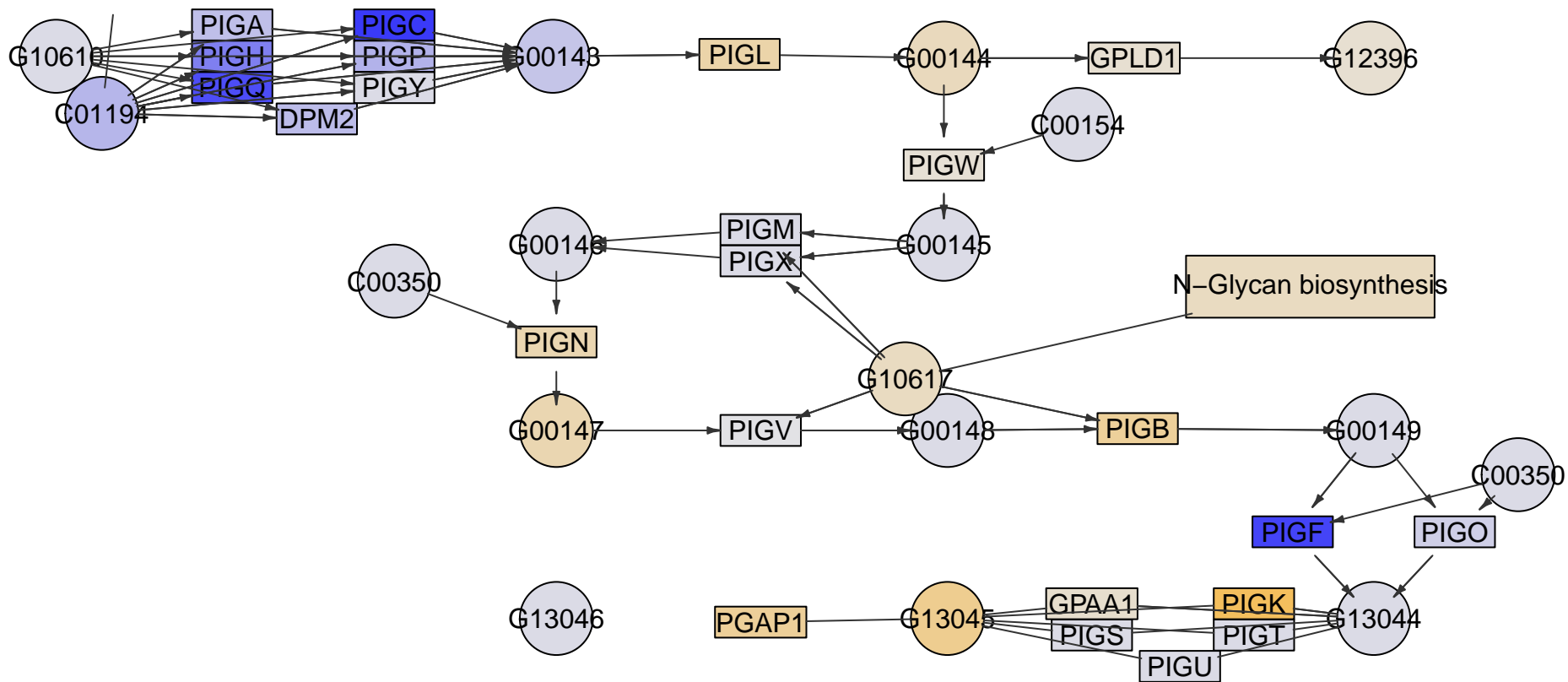

PIGK

PIGO

PIGG

PIGN

PIGZ

PIGB

PIGV

PIGM

PIGA

Glycosylphosphatidylinositol(GPI)-anchor
biosynthesis
MPI-045

Glycerophospholipid
metabolism

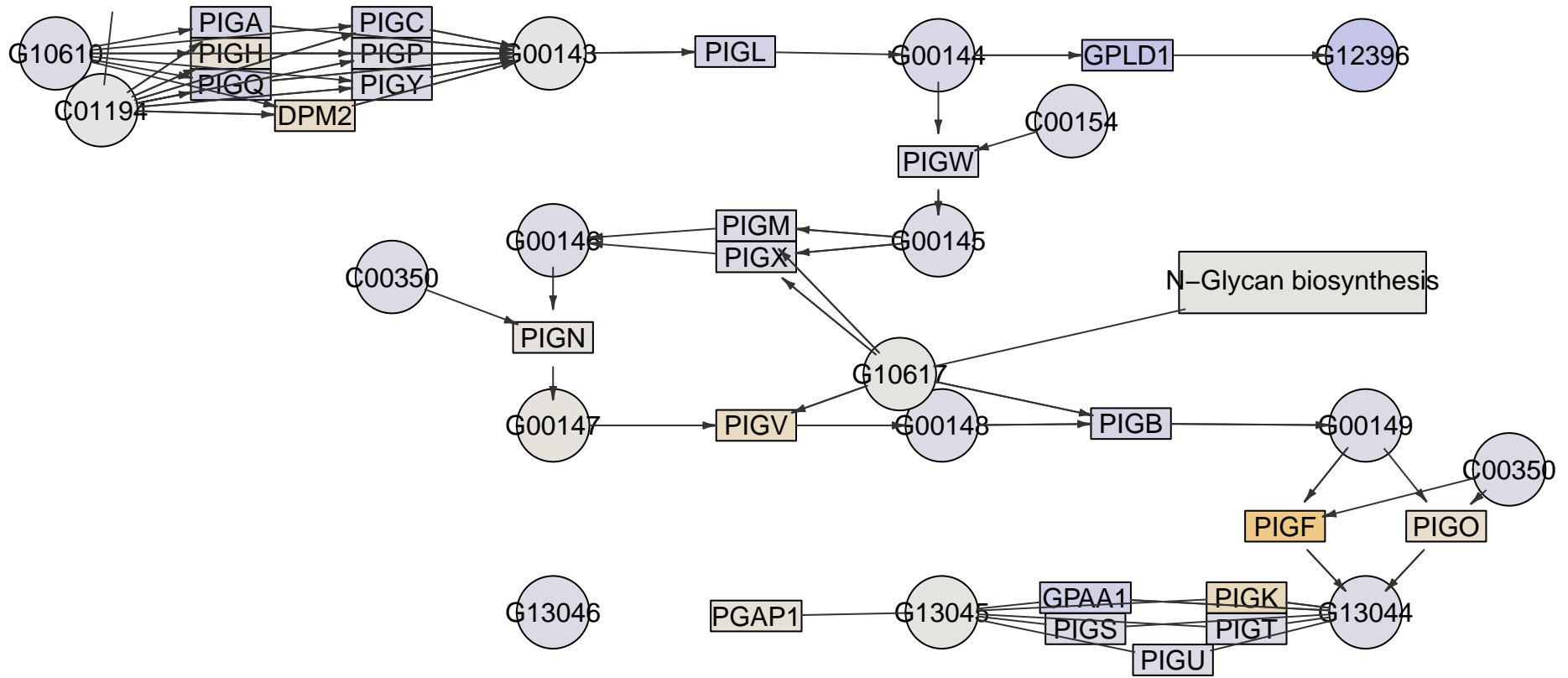

PIGK

PIGO

PIGG

PIGN

PIGZ

PIGB

PIGV

PIGM

PIGA

Glycosylphosphatidylinositol(GPI)-anchor
biosynthesis
MPI-047

Glycerophospholipid
metabolism

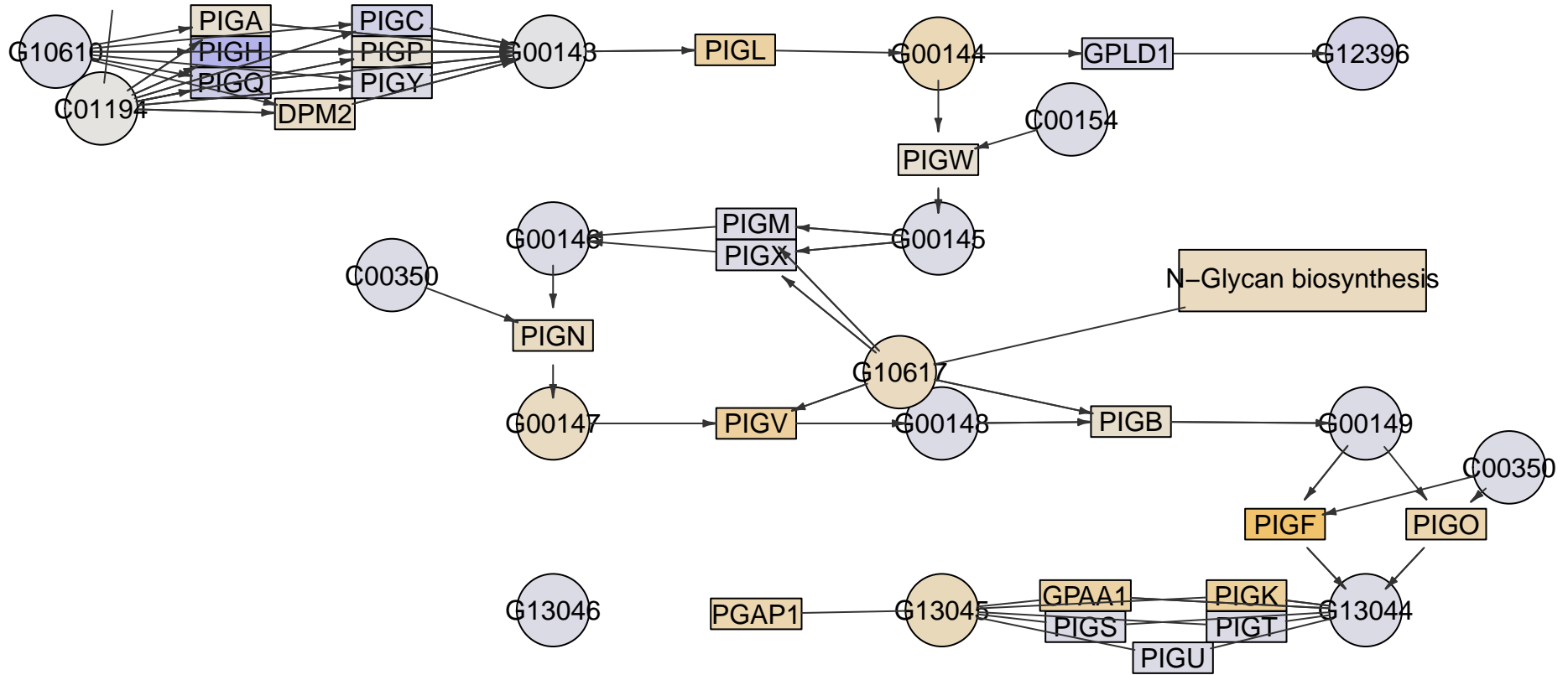

PIGK

PIGO

PIGG

PIGN

PIGZ

PIGB

PIGV

PIGM

PIGA

Glycosylphosphatidylinositol(GPI)-anchor
biosynthesis
MPI-053

Glycerophospholipid
metabolism

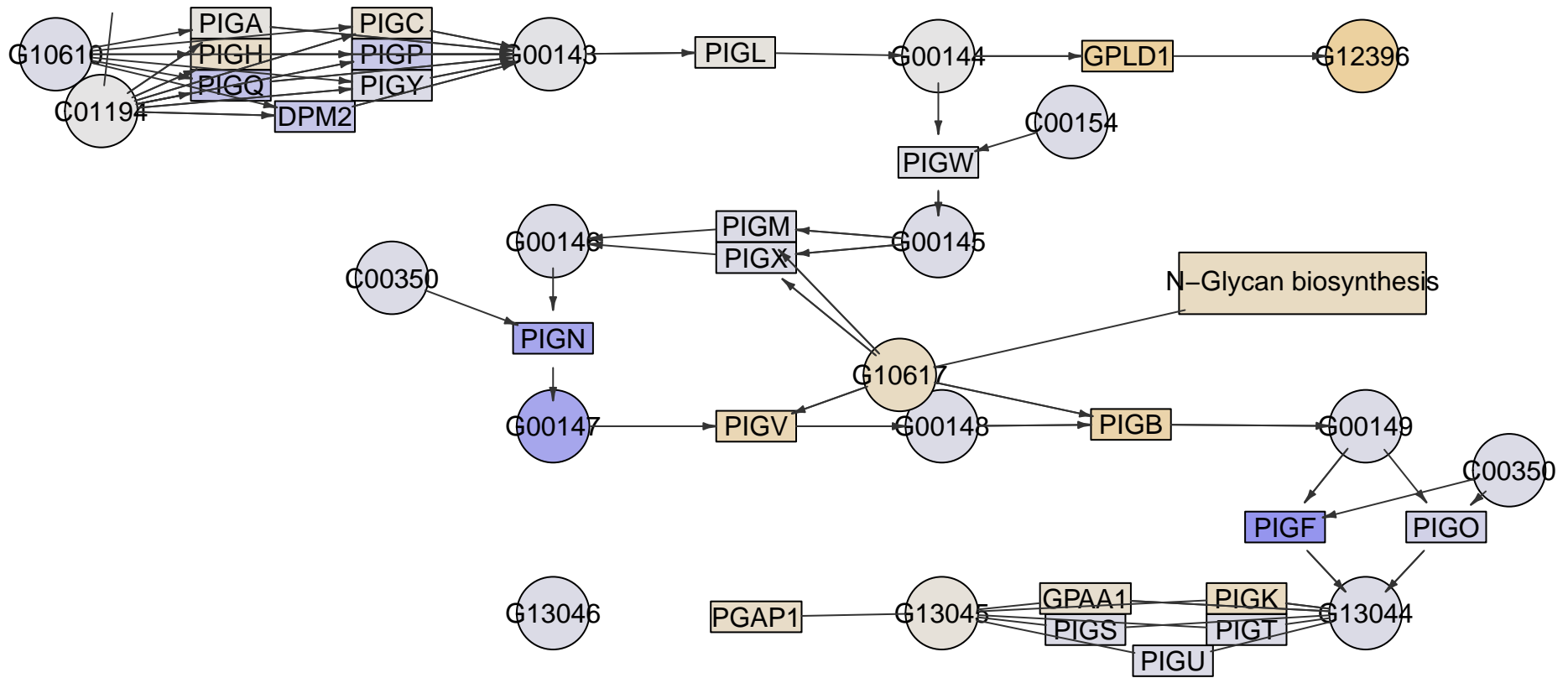

PIGK

PIGO

PIGG

PIGN

PIGZ

PIGB

PIGV

PIGM

PIGA

Glycosylphosphatidylinositol(GPI)-anchor
biosynthesis
MPI-062

Glycerophospholipid
metabolism

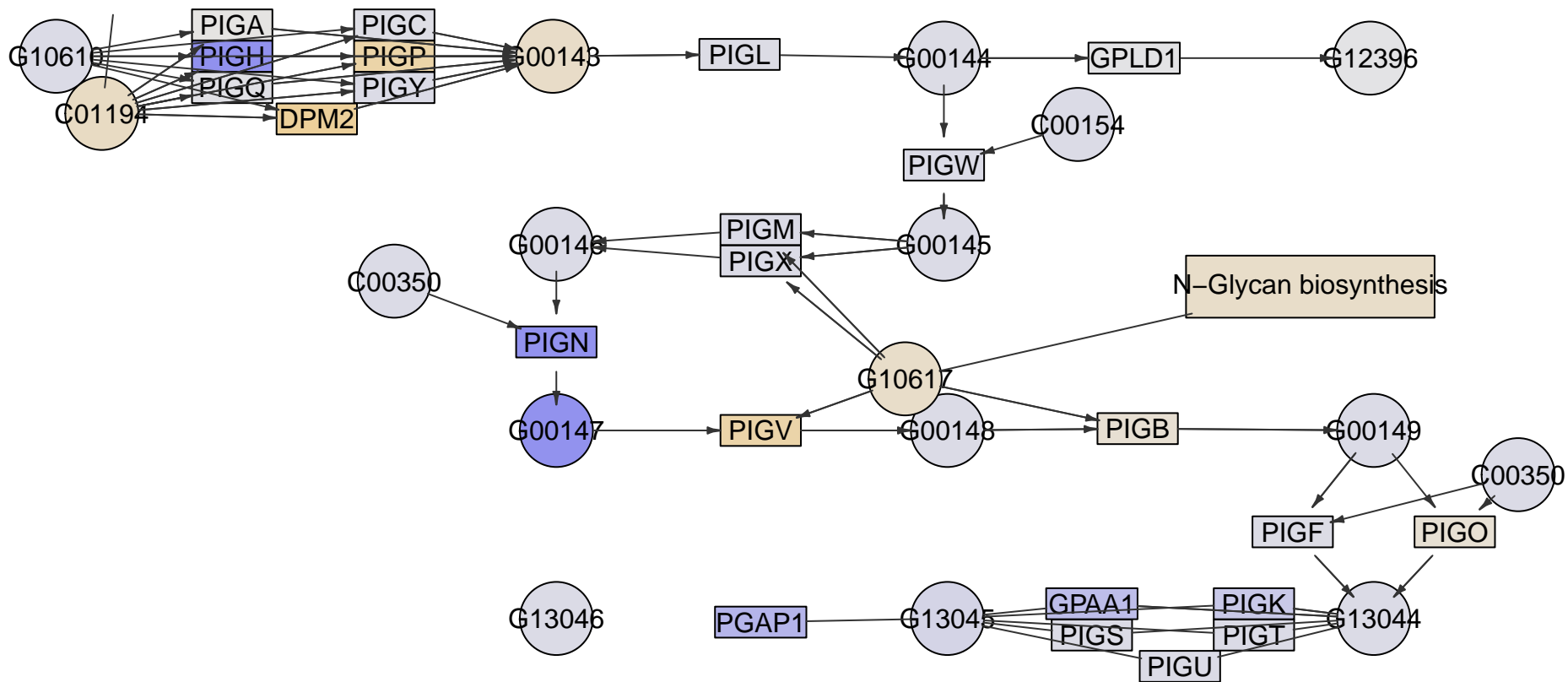

PIGK

PIGO

PIGG

PIGN

PIGZ

PIGB

PIGV

PIGM

PIGA

Glycosylphosphatidylinositol(GPI)-anchor
biosynthesis
MPI-063

Glycerophospholipid
metabolism

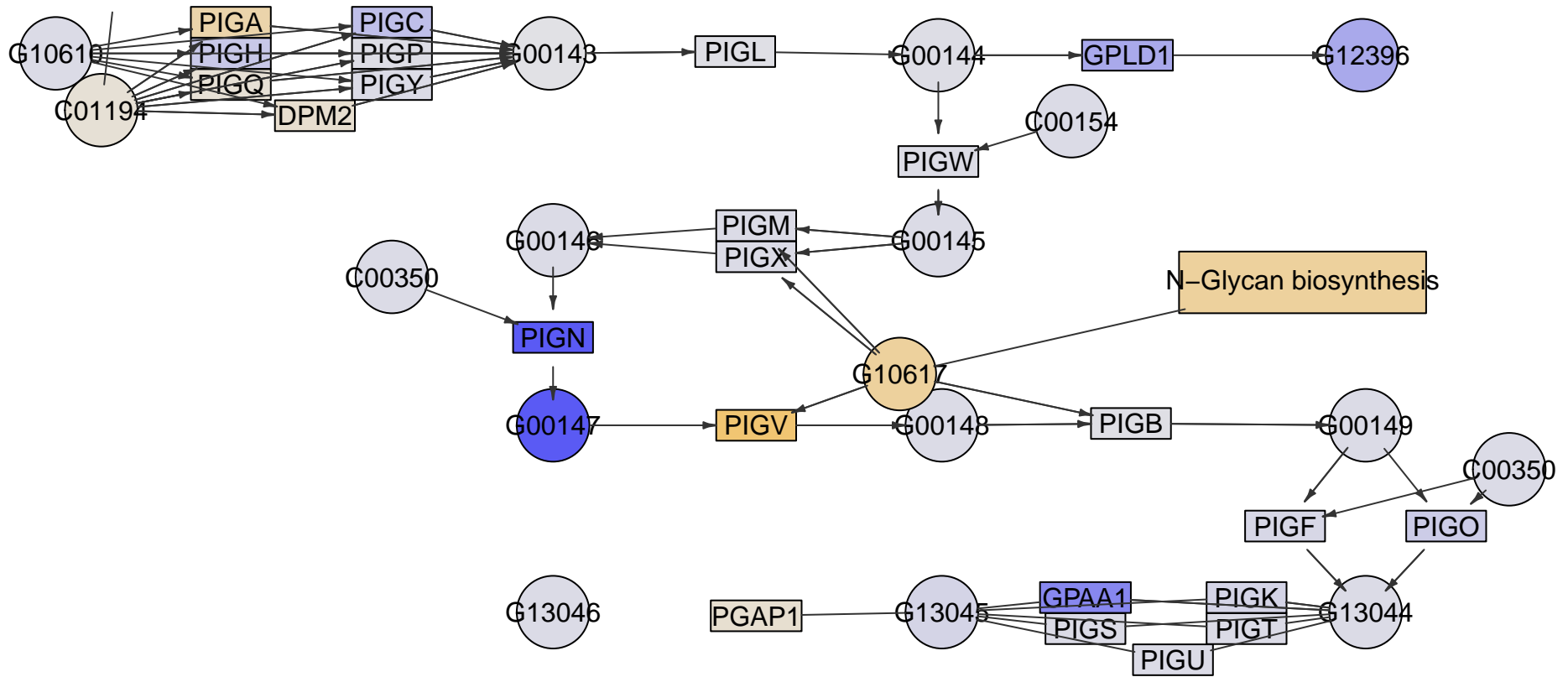

PIGK

PIGO

PIGG

PIGN

PIGZ

PIGB

PIGV

PIGM

PIGA

Glycosylphosphatidylinositol(GPI)-anchor
biosynthesis
MPI-069

Glycerophospholipid
metabolism

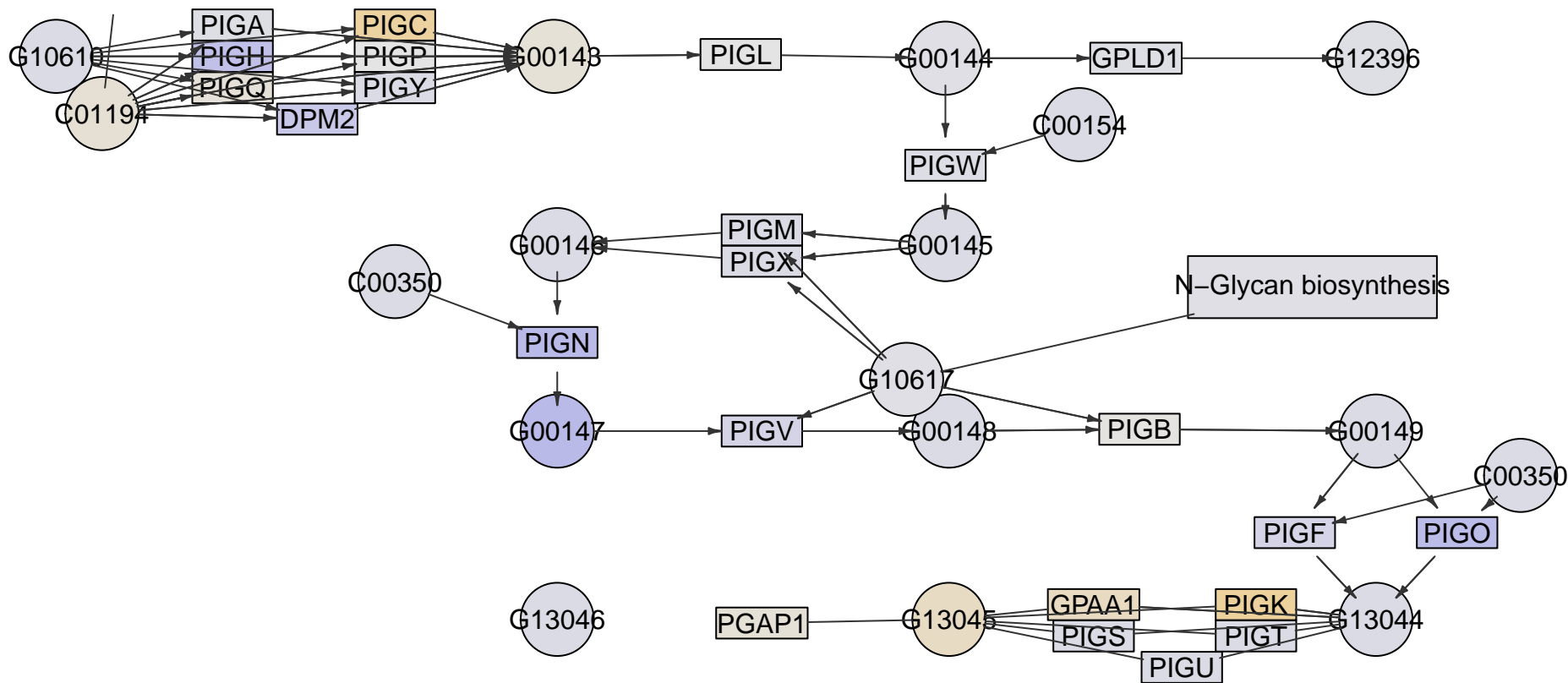

PIGK

PIGO

PIGG

PIGN

PIGZ

PIGB

PIGV

PIGM

PIGA

Glycosylphosphatidylinositol(GPI)-anchor
biosynthesis
MPI-073

Glycerophospholipid
metabolism

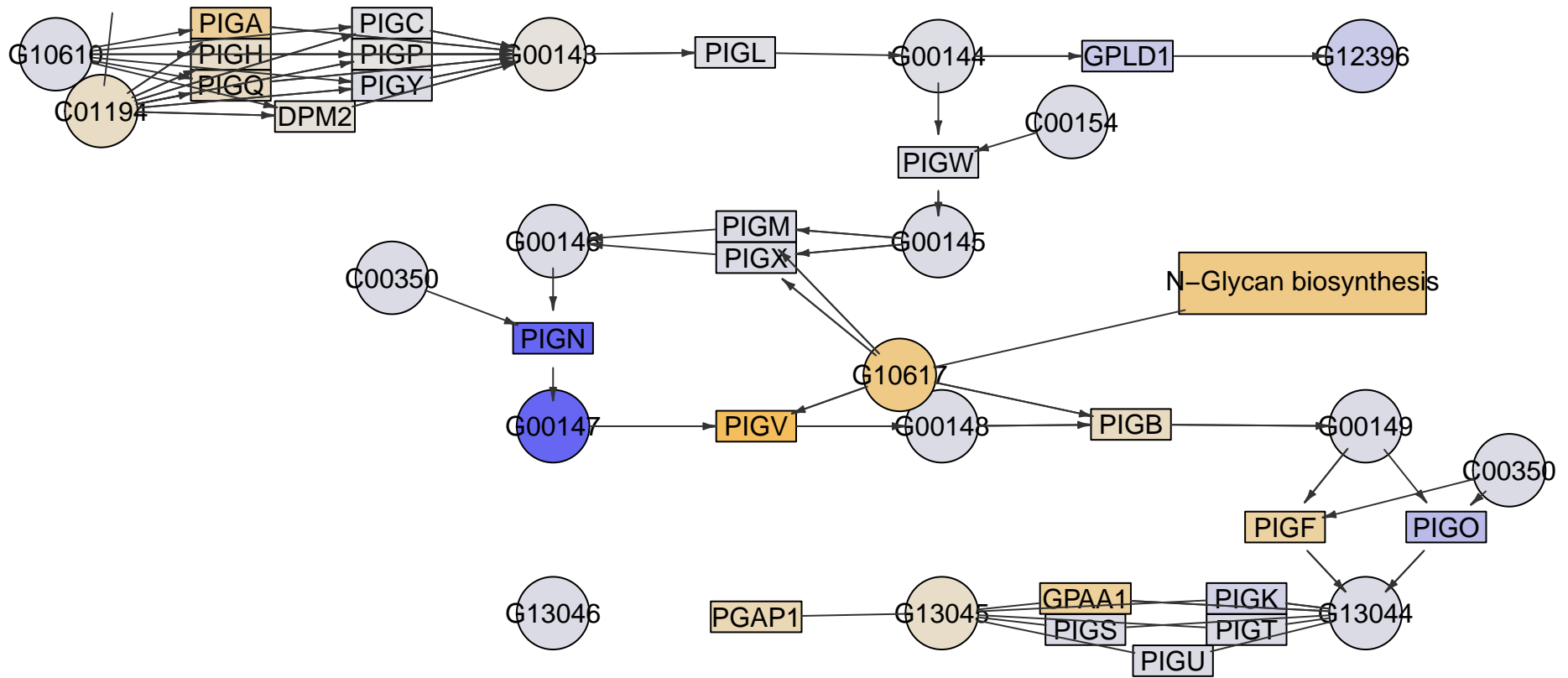

PIGK

PIGO

PIGG

PIGN

PIGZ

PIGB

PIGV

PIGM

PIGA

Glycosylphosphatidylinositol(GPI)-anchor
biosynthesis
MPI-074

Glycerophospholipid
metabolism

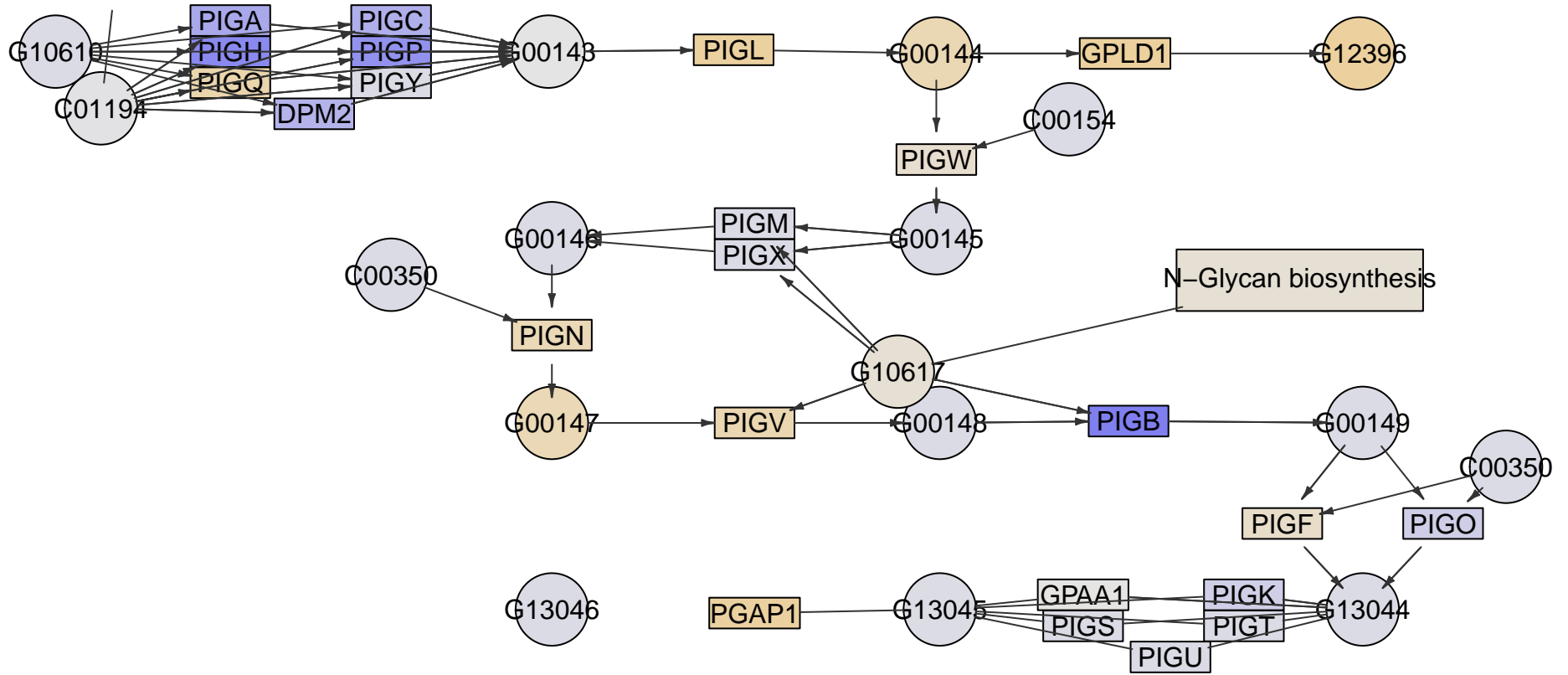

PIGK

PIGO

PIGG

PIGN

PIGZ

PIGB

PIGV

PIGM

PIGA

Glycosylphosphatidylinositol(GPI)-anchor
biosynthesis
MPI-076

Glycerophospholipid
metabolism

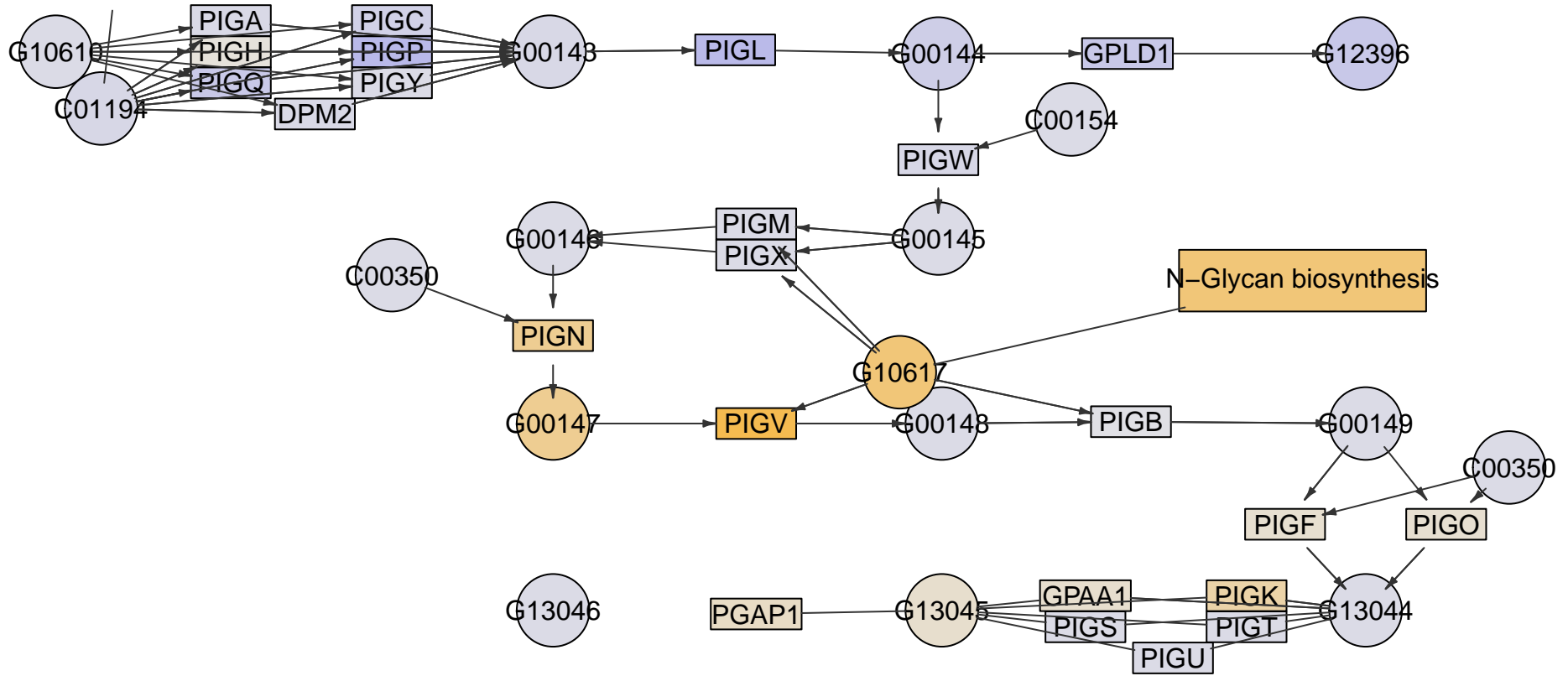

N-Glycan biosynthesis

PIGK

PIGO

PIGG

PIGN

PIGZ

PIGB

PIGV

PIGM

PIGA

Glycosylphosphatidylinositol(GPI)-anchor
biosynthesis
MPI-083

Glycerophospholipid
metabolism

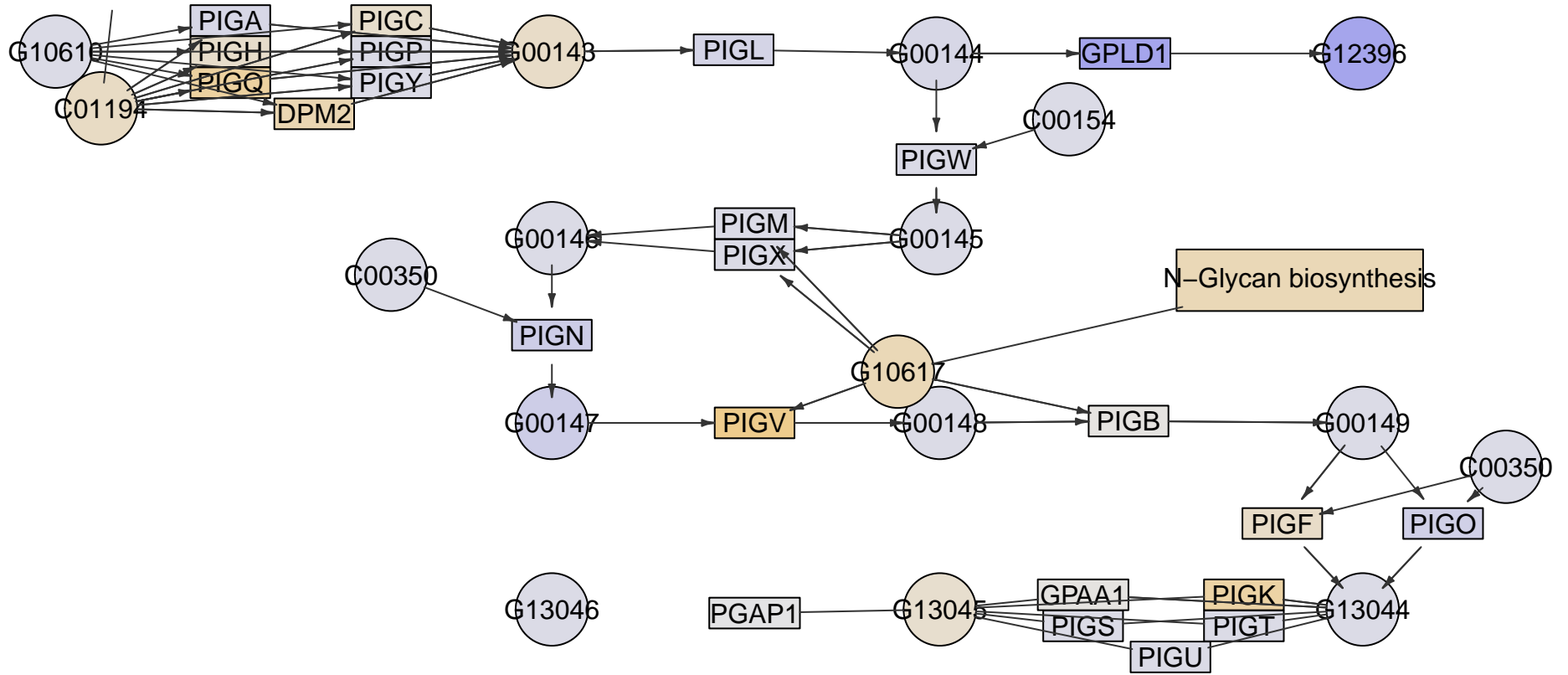

PIGK

PIGO

PIGG

PIGN

PIGZ

PIGB

PIGV

PIGM

PIGA

Glycosylphosphatidylinositol(GPI)-anchor
biosynthesis
MPI-088

Glycerophospholipid
metabolism

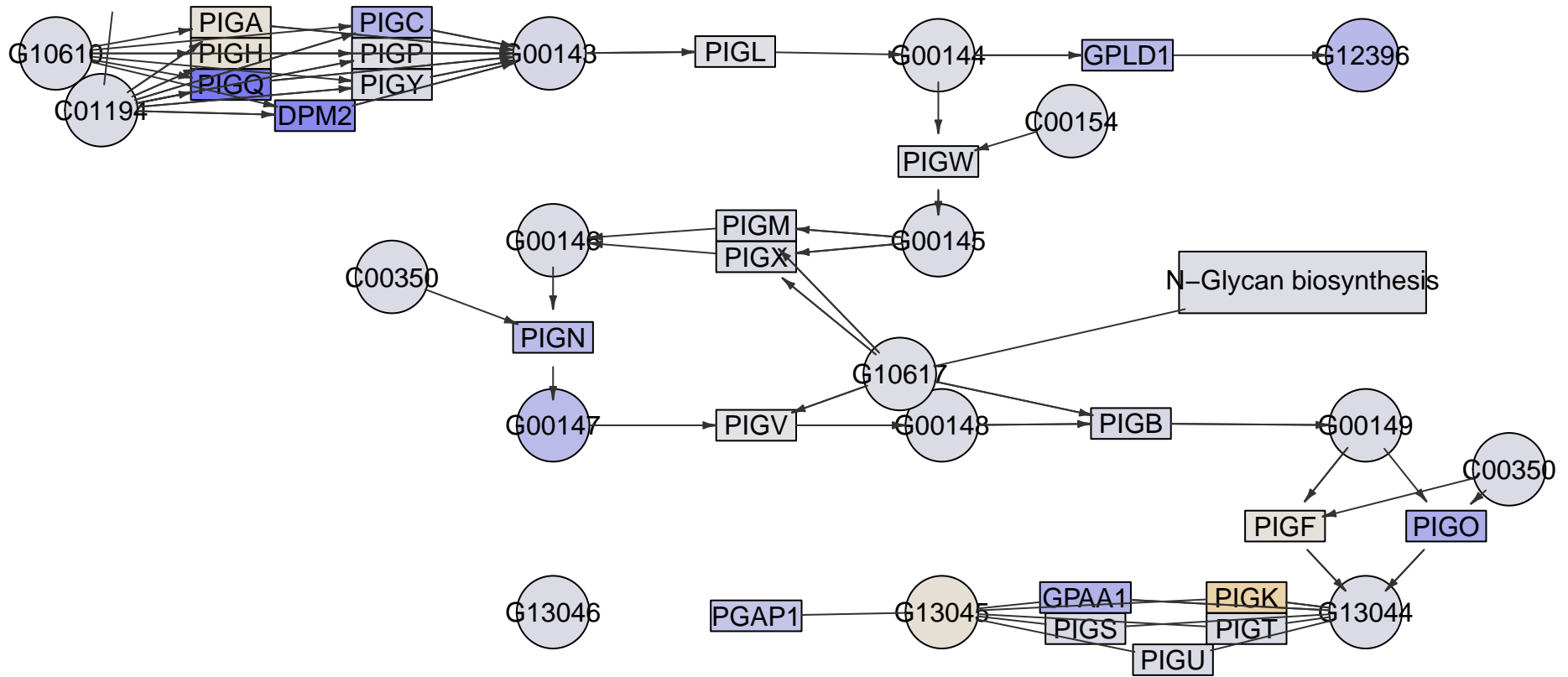

PIGK

PIGO

PIGG

PIGN

PIGZ

PIGB

PIGV

PIGM

PIGA

Glycosylphosphatidylinositol(GPI)-anchor
biosynthesis
MPI-092

Glycerophospholipid
metabolism

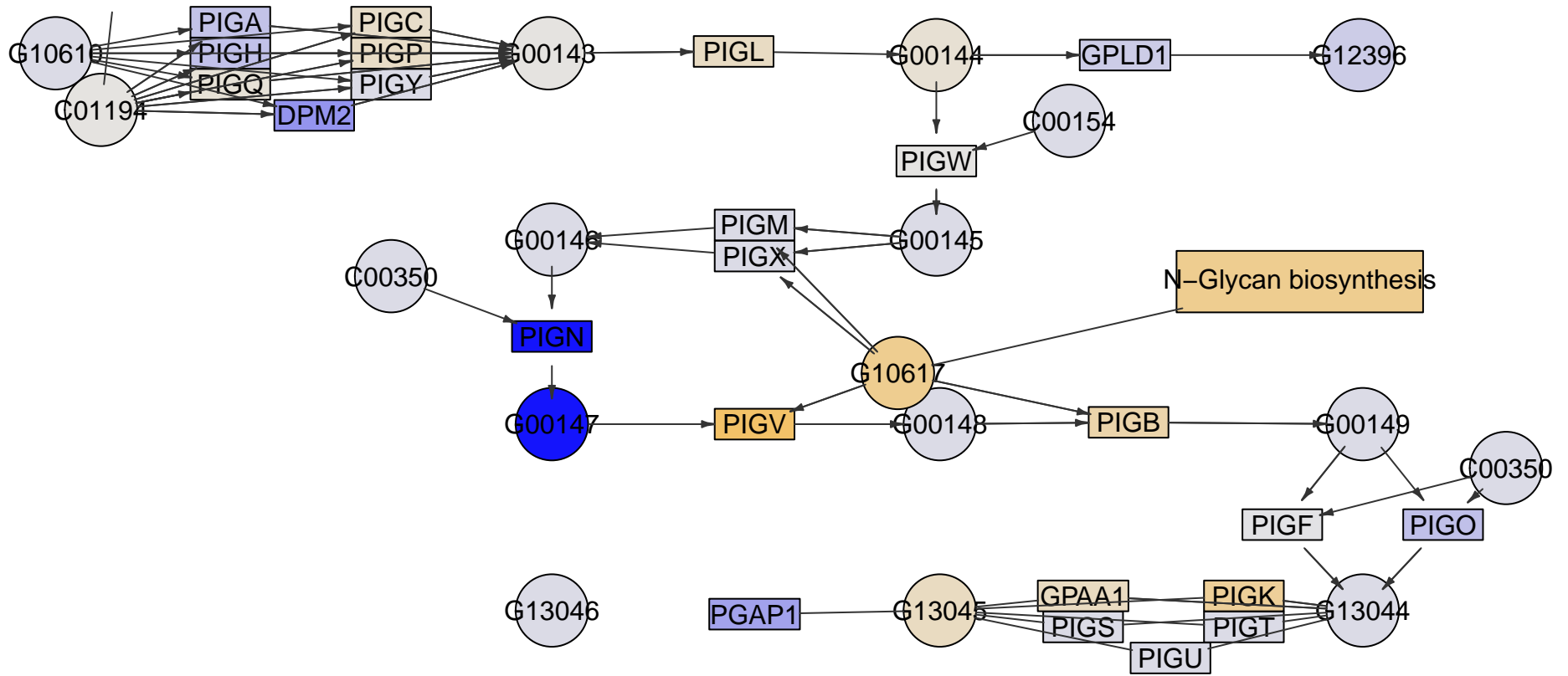

PIGK

PIGO

PIGG

PIGN

PIGZ

PIGB

PIGV

PIGM

PIGA

Glycosylphosphatidylinositol(GPI)-anchor
biosynthesis
MPI-096

Glycerophospholipid
metabolism

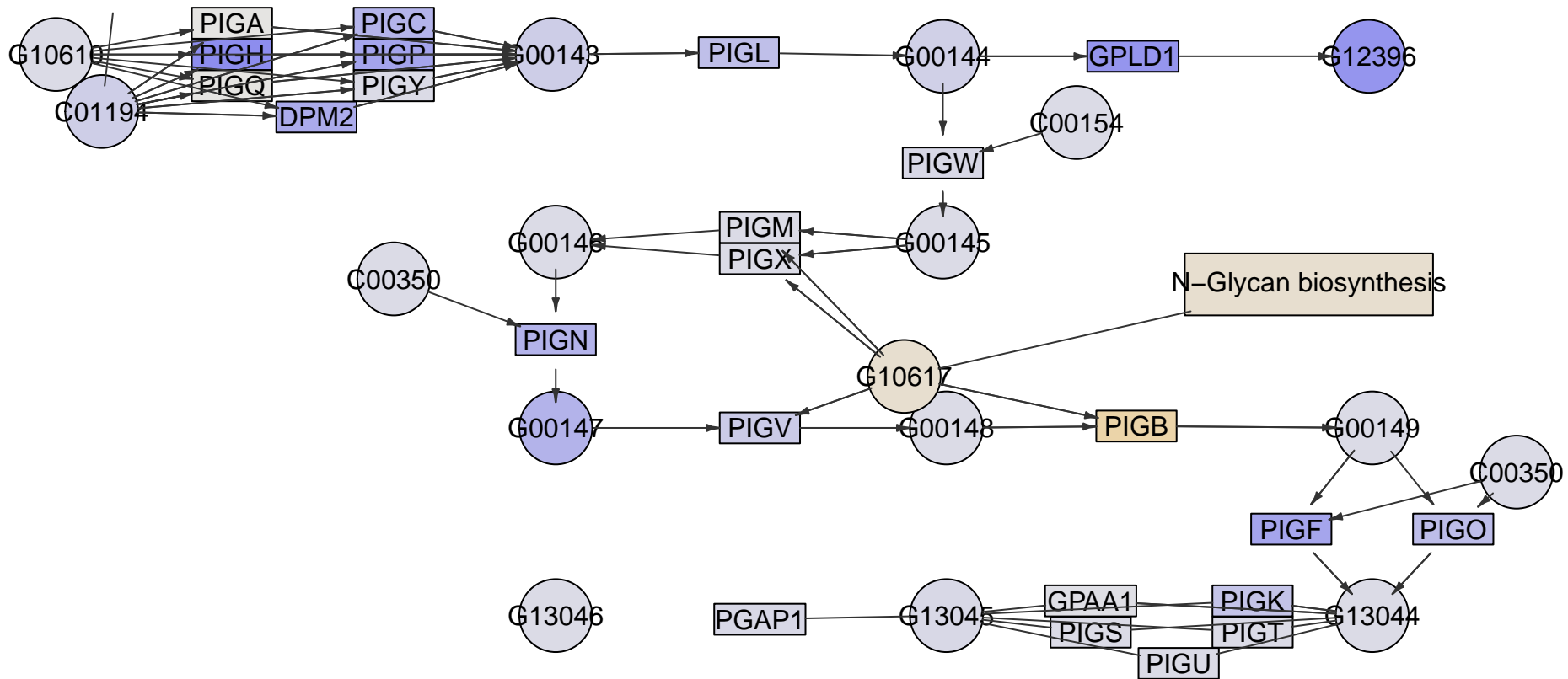

PIGK

PIGO

PIGG

PIGN

PIGZ

PIGB

PIGV

PIGM

PIGA

Glycosylphosphatidylinositol(GPI)-anchor
biosynthesis
MPI-098

Glycerophospholipid
metabolism

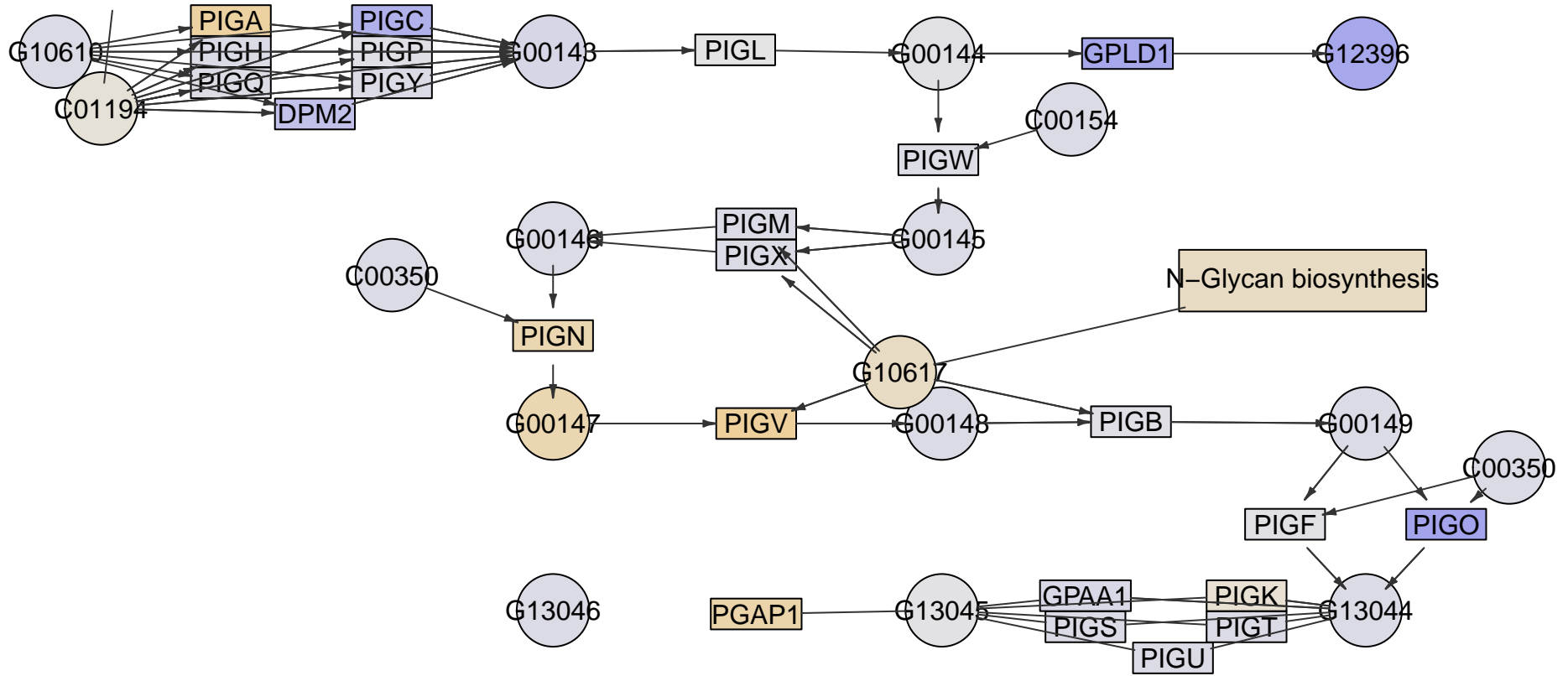

PIGK

PIGO

PIGG

PIGN

PIGZ

PIGB

PIGV

PIGM

PIGA

Glycosylphosphatidylinositol(GPI)-anchor
biosynthesis
MPI-100

Glycerophospholipid
metabolism

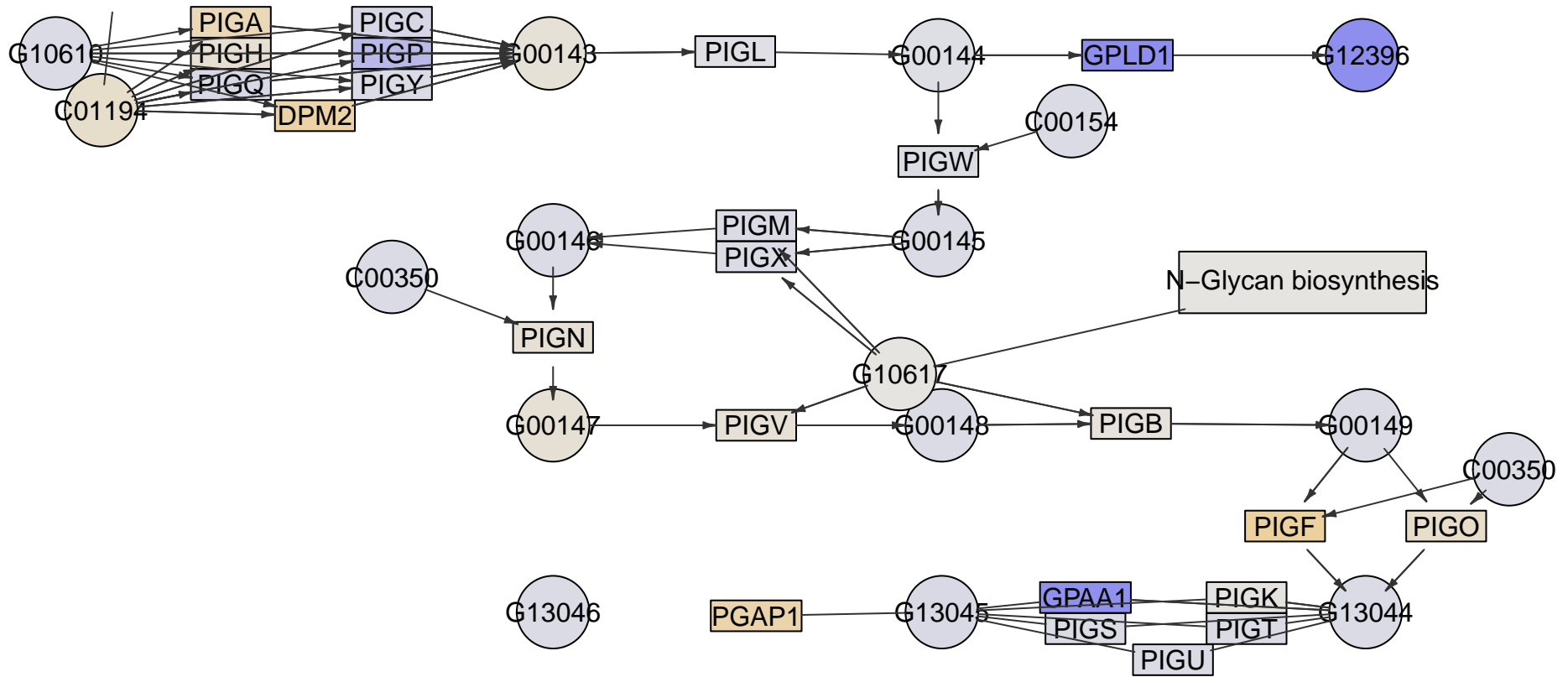

PIGK

PIGO

PIGG

PIGN

PIGZ

PIGB

PIGV

PIGM

PIGA

Glycosylphosphatidylinositol(GPI)-anchor
biosynthesis
MPI-105

Glycerophospholipid
metabolism

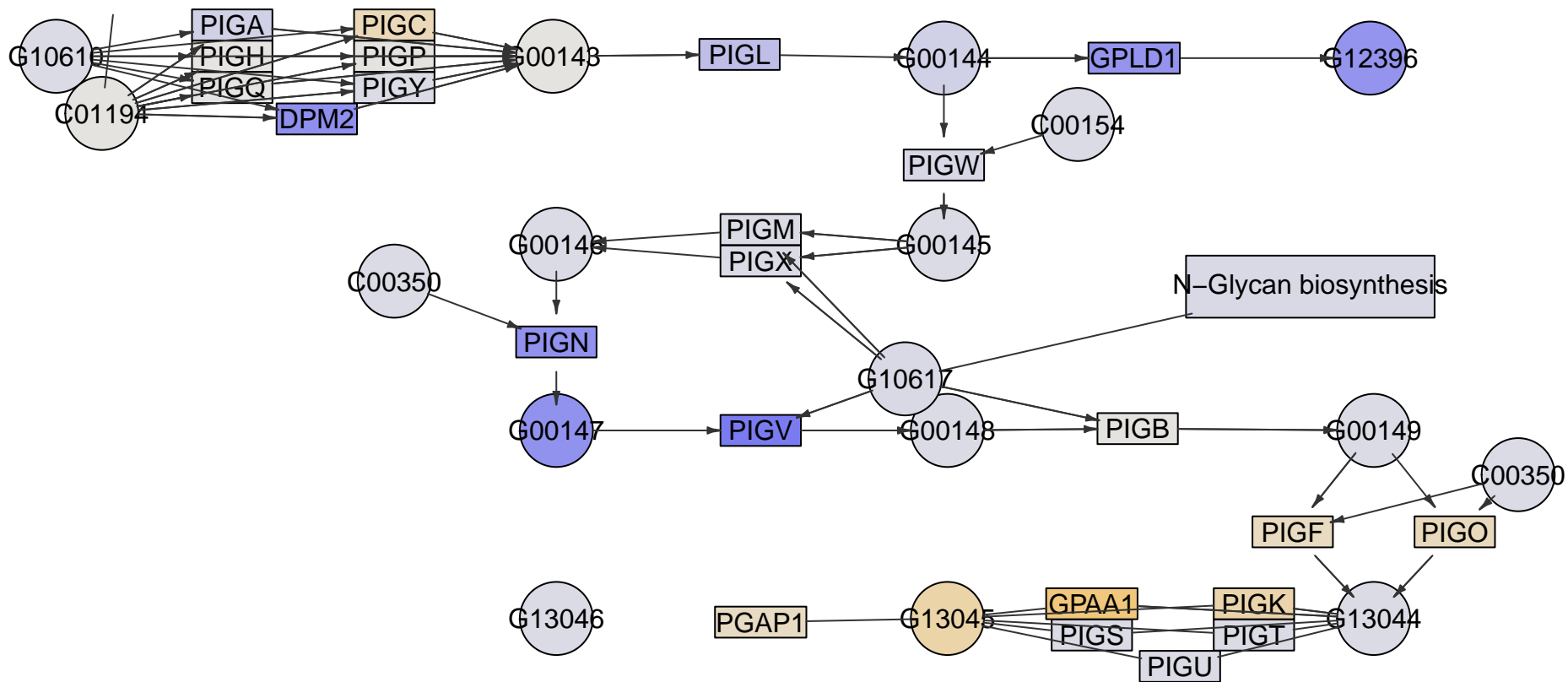

PIGK

PIGO

PIGG

PIGN

PIGZ

PIGB

PIGV

PIGM

PIGA

Glycosylphosphatidylinositol(GPI)-anchor
biosynthesis
MPI-106

Glycerophospholipid
metabolism

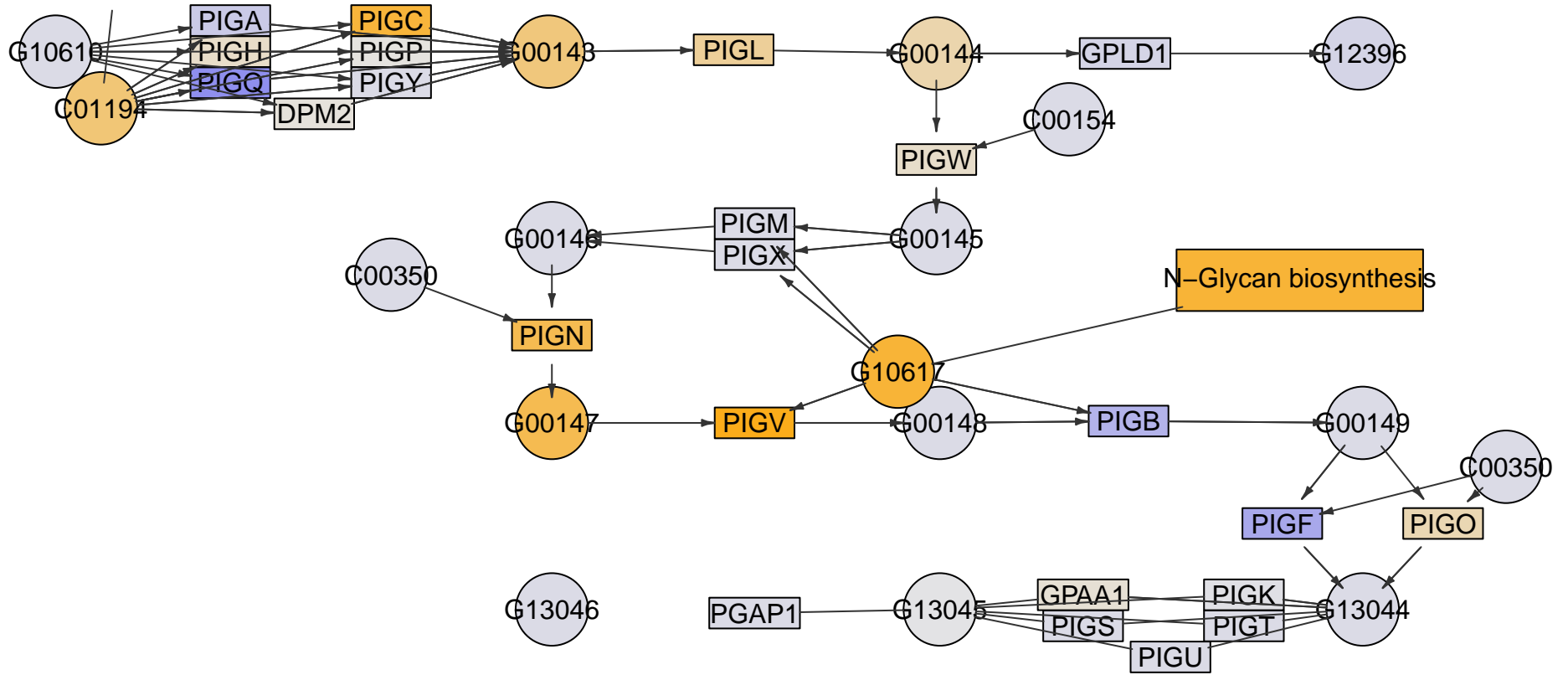

PIGK

PIGO

PIGG

PIGN

PIGZ

PIGB

PIGV

PIGM

PIGA

Glycosylphosphatidylinositol(GPI)-anchor
biosynthesis
MPI-108

Glycerophospholipid
metabolism

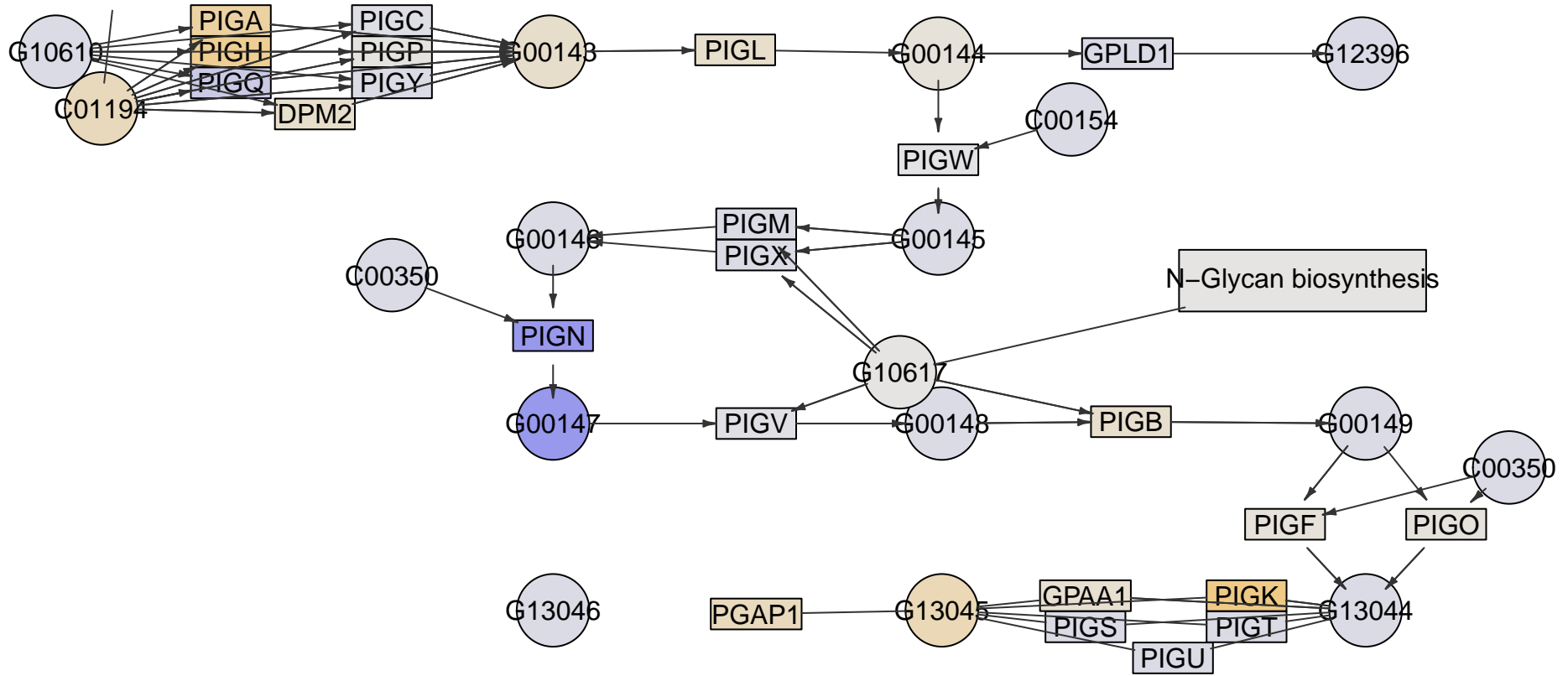

PIGK

PIGO

PIGG

PIGN

PIGZ

PIGB

PIGV

PIGM

PIGA

Glycosylphosphatidylinositol(GPI)-anchor
biosynthesis
MPI-109

Glycerophospholipid
metabolism

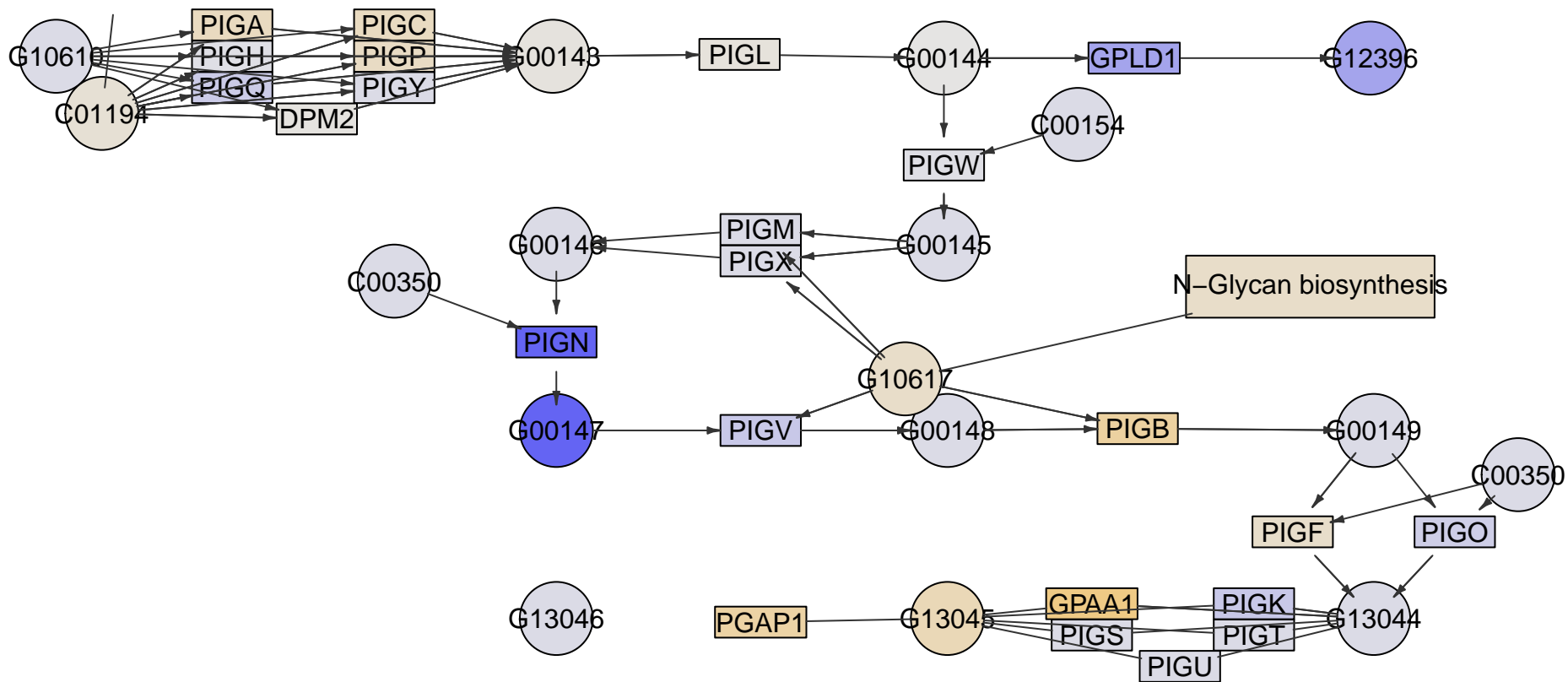

PIGK

PIGO

PIGG

PIGN

PIGZ

PIGB

PIGV

PIGM

PIGA

Glycosylphosphatidylinositol(GPI)-anchor
biosynthesis
MPI-110

Glycerophospholipid
metabolism

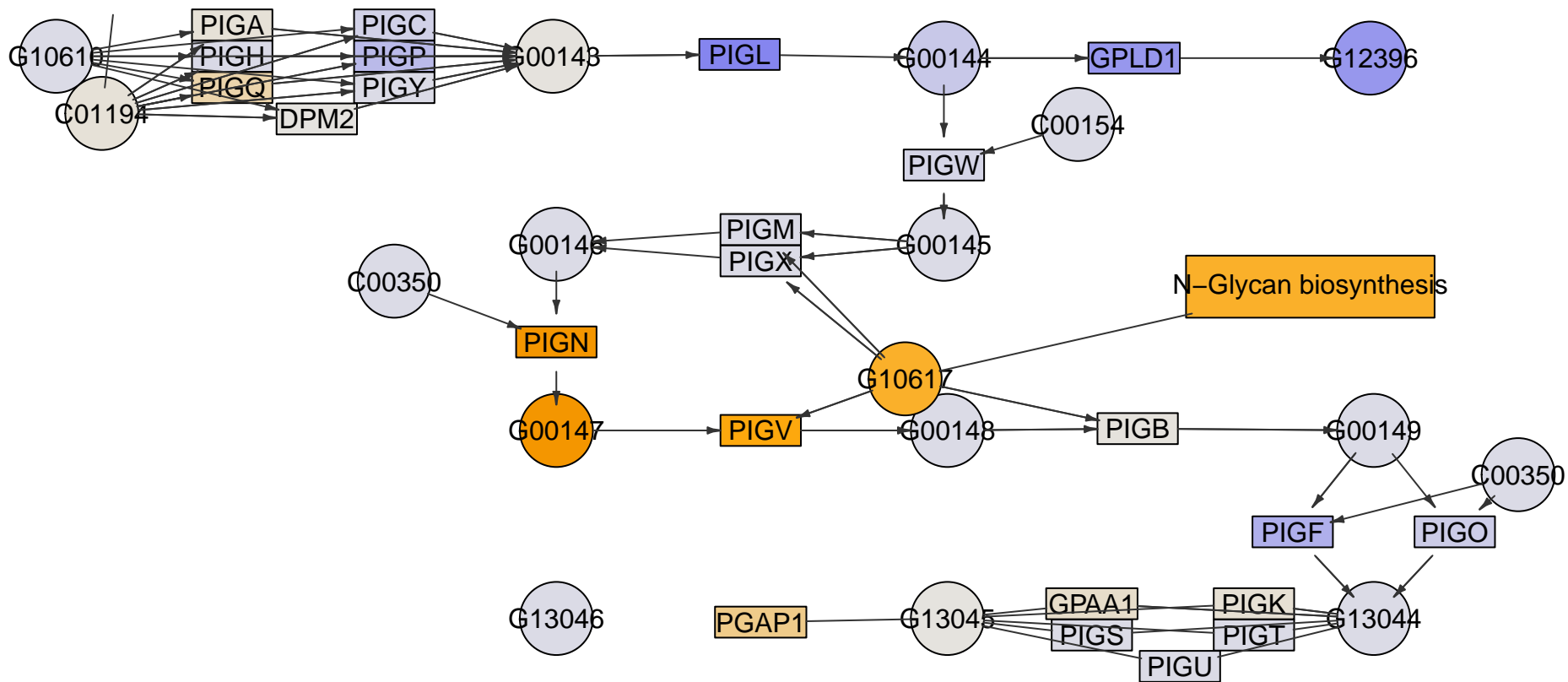

PIGK

PIGO

PIGG

PIGN

PIGZ

PIGB

PIGV

PIGM

PIGA

Glycosylphosphatidylinositol(GPI)-anchor
biosynthesis
MPI-111

Glycerophospholipid
metabolism

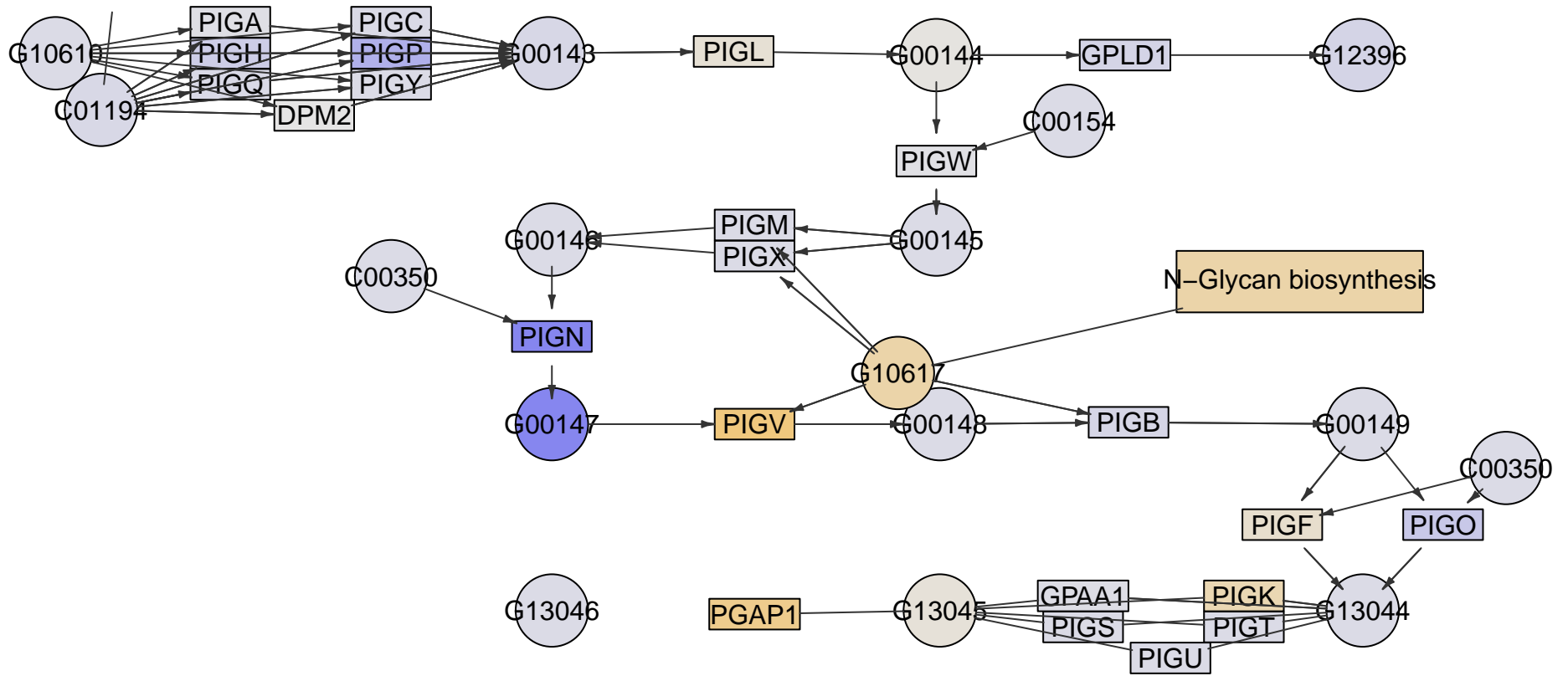

N-Glycan biosynthesis

PIGK

PIGO

PIGG

PIGN

PIGZ

PIGB

PIGV

PIGM

PIGA

Glycosylphosphatidylinositol(GPI)-anchor
biosynthesis
MPI-113

Glycerophospholipid
metabolism

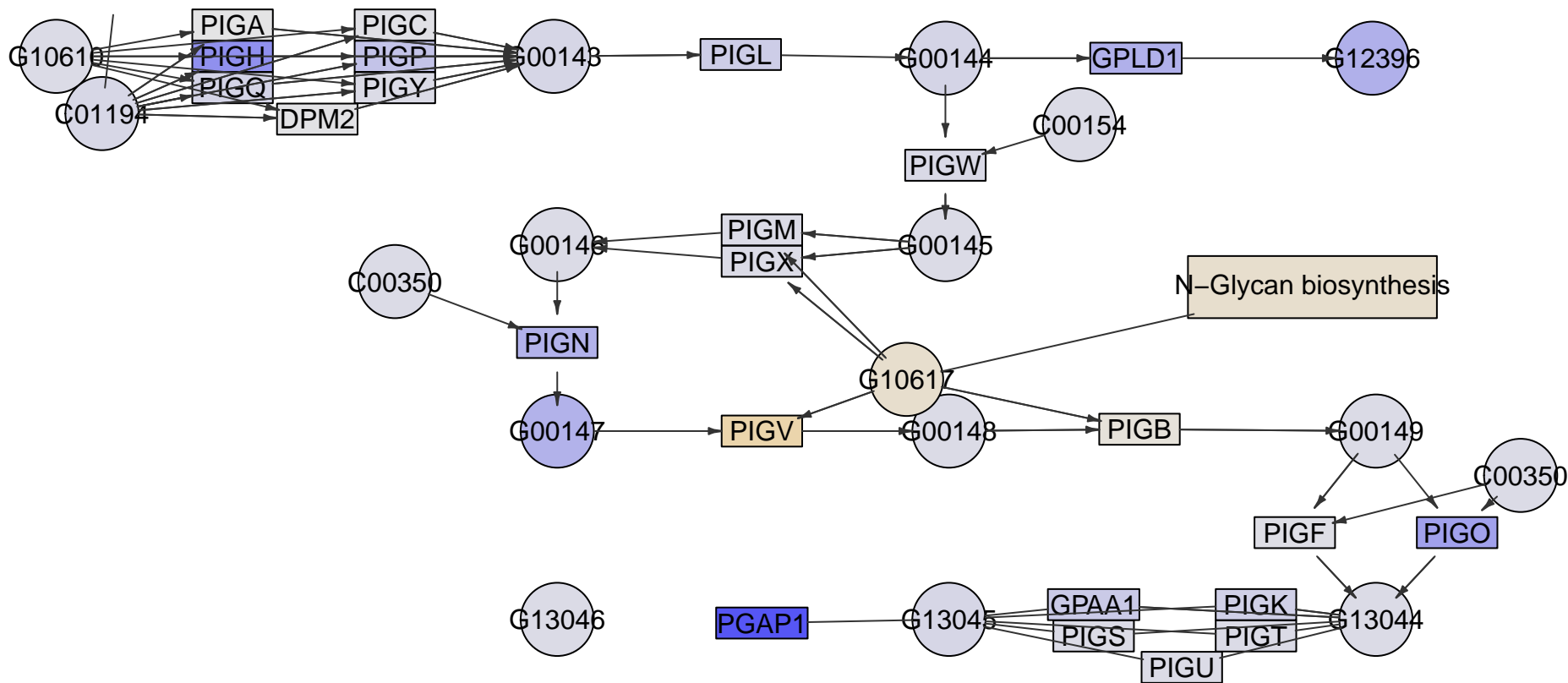

N-Glycan biosynthesis

PIGK

PIGO

PIGG

PIGN

PIGZ

PIGB

PIGV

PIGM

PIGA

Glycosylphosphatidylinositol(GPI)-anchor
biosynthesis
MPI-115

Glycerophospholipid
metabolism

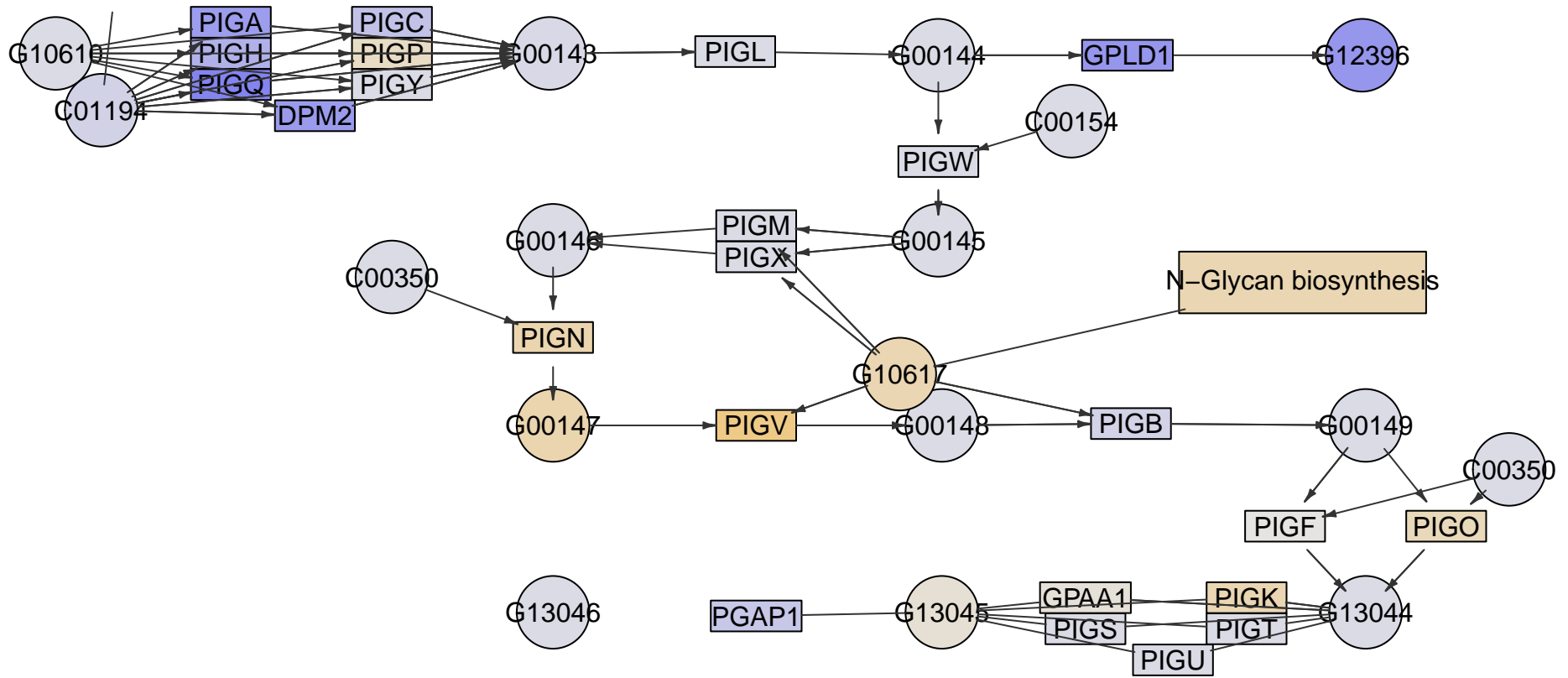

PIGK

PIGO

PIGG

PIGN

PIGZ

PIGB

PIGV

PIGM

PIGA

Glycosylphosphatidylinositol(GPI)-anchor
biosynthesis
MPI-118

Glycerophospholipid
metabolism

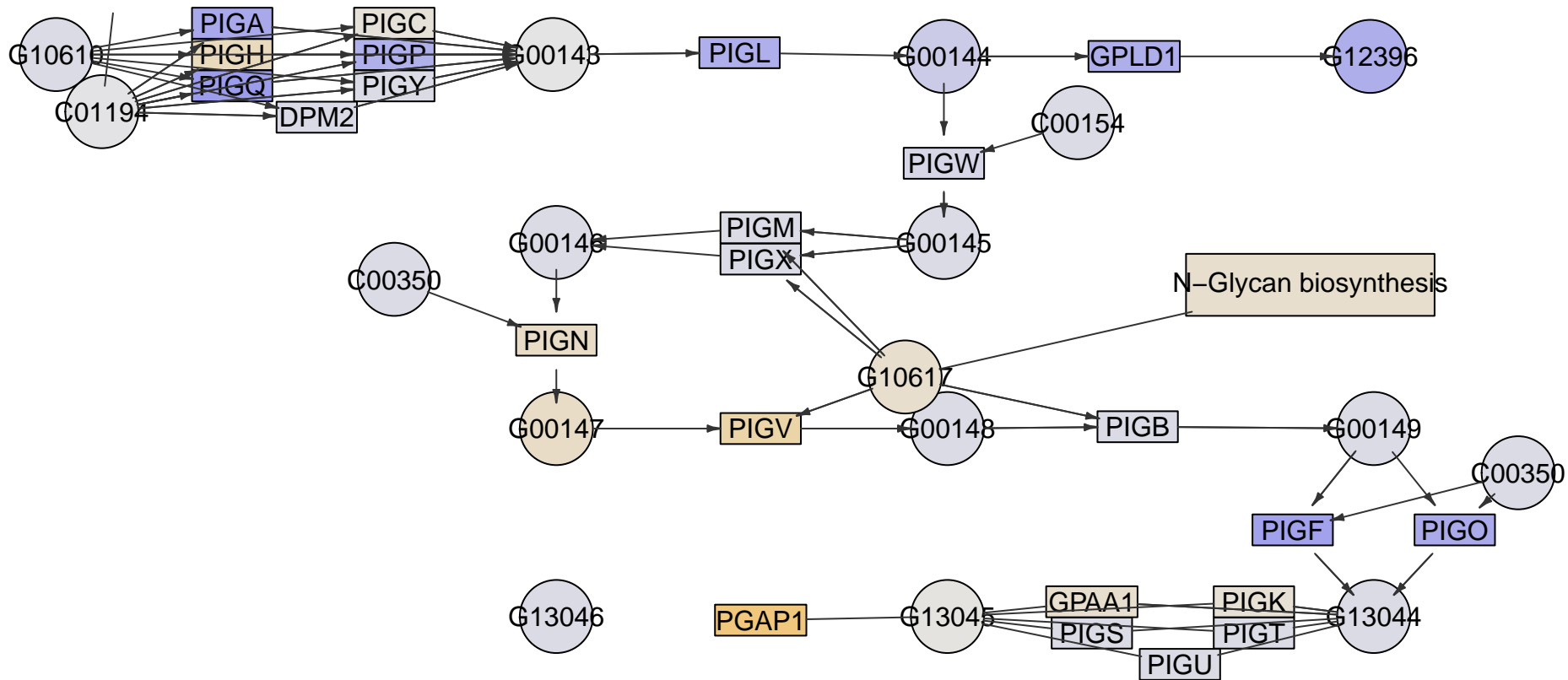

N-Glycan biosynthesis

PIGK

PIGO

PIGG

PIGN

PIGZ

PIGB

PIGV

PIGM

PIGA

Glycosylphosphatidylinositol(GPI)-anchor
biosynthesis
MPI-119

Glycerophospholipid
metabolism

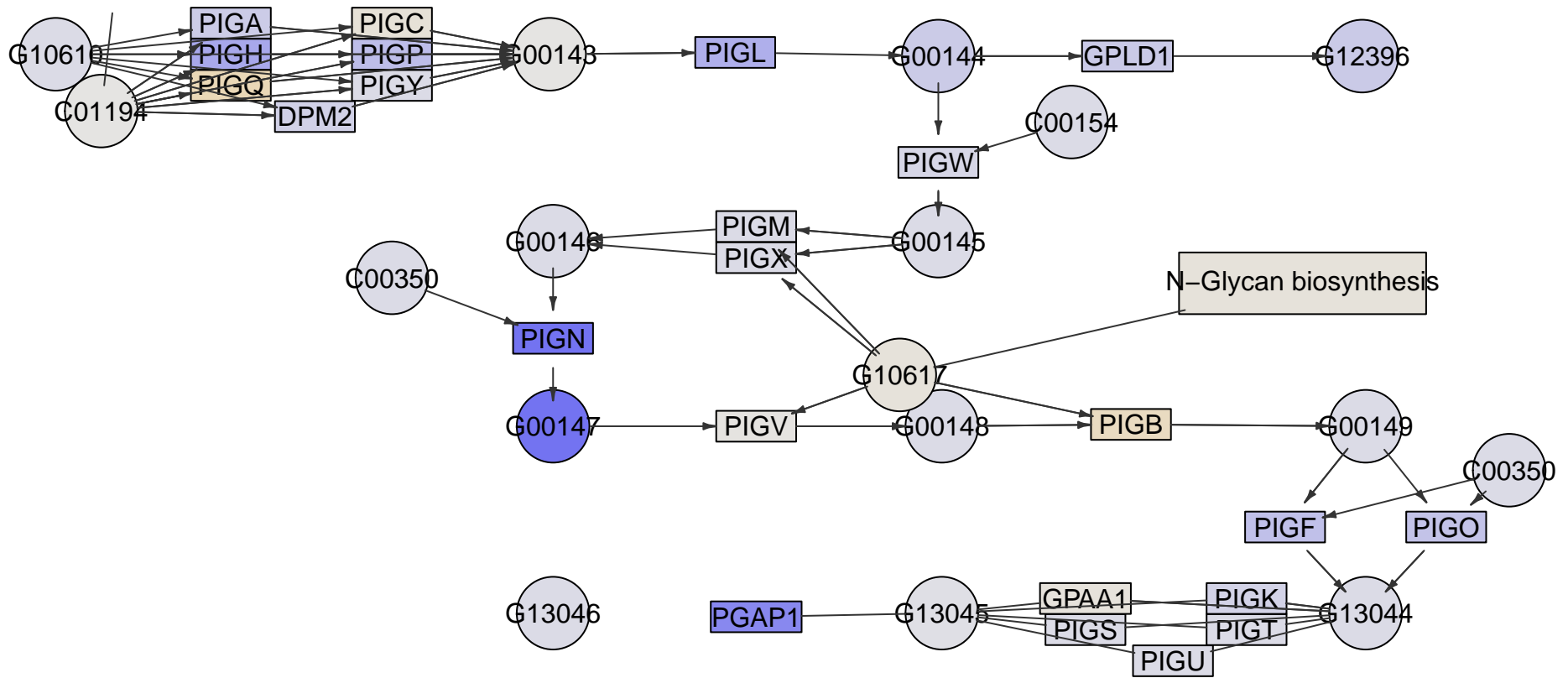

PIGK

PIGO

PIGG

PIGN

PIGZ

PIGB

PIGV

PIGM

PIGA

Glycosylphosphatidylinositol(GPI)-anchor
biosynthesis
MPI-122

Glycerophospholipid
metabolism

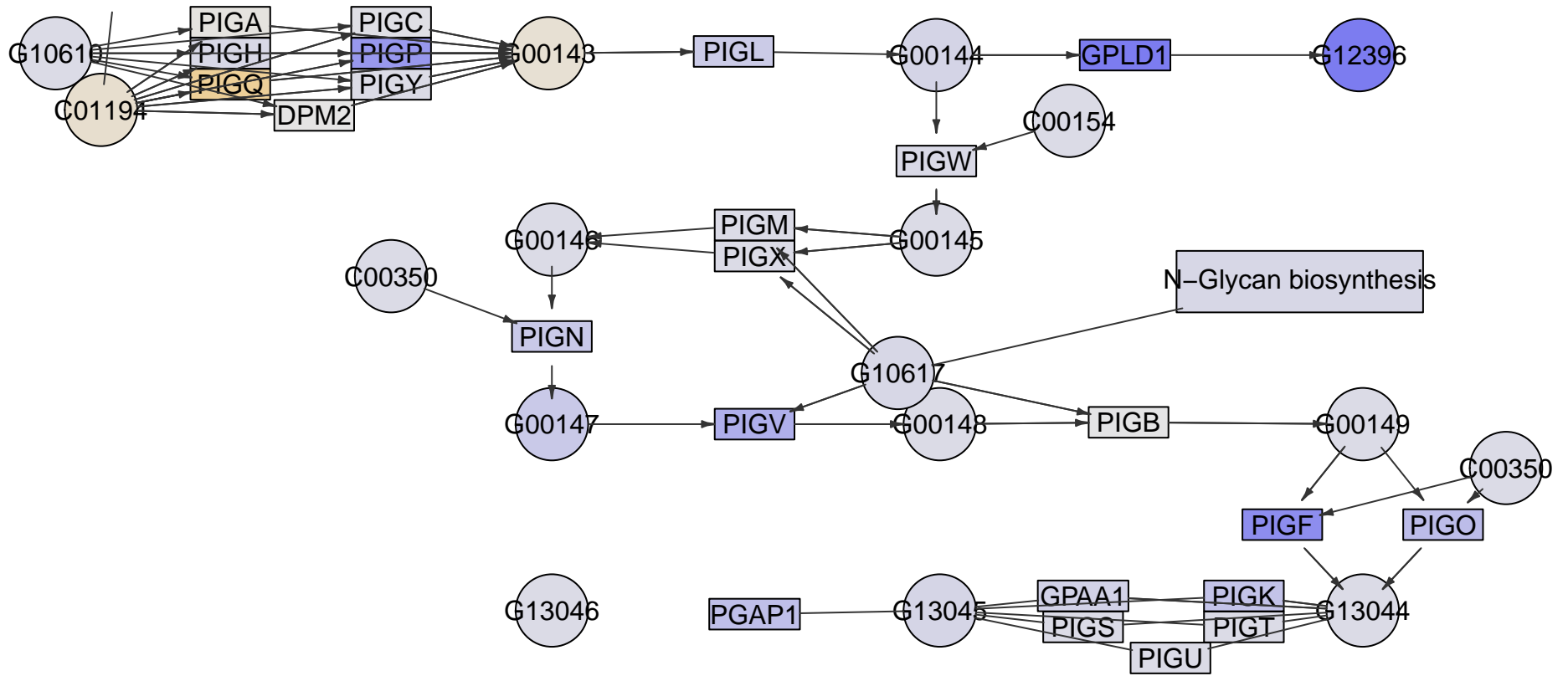

PIGK

PIGO

PIGG

PIGN

PIGZ

PIGB

PIGV

PIGM

PIGA

Glycosylphosphatidylinositol(GPI)-anchor
biosynthesis
MPI-127

Glycerophospholipid
metabolism

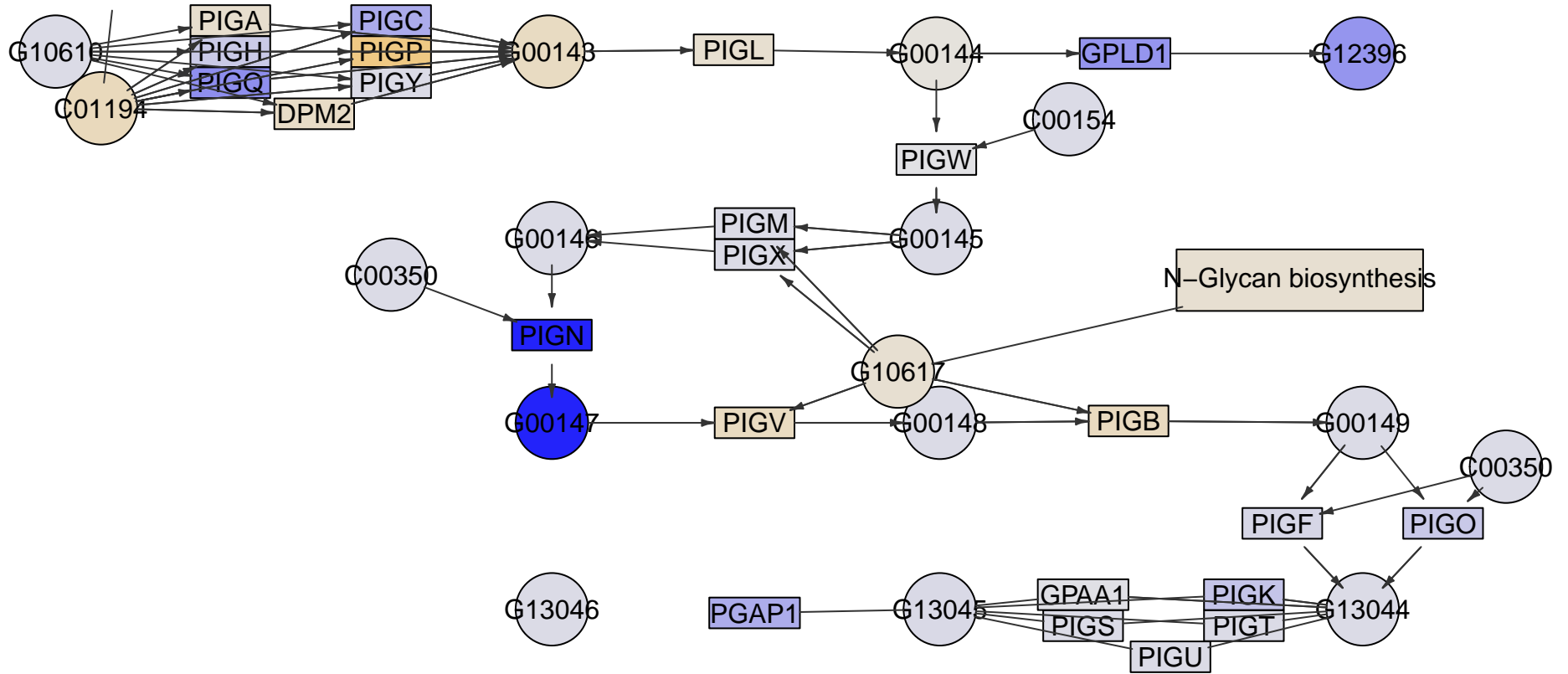

PIGK

PIGO

PIGG

PIGN

PIGZ

PIGB

PIGV

PIGM

PIGA

Glycosylphosphatidylinositol(GPI)-anchor
biosynthesis
MPI-128

Glycerophospholipid
metabolism

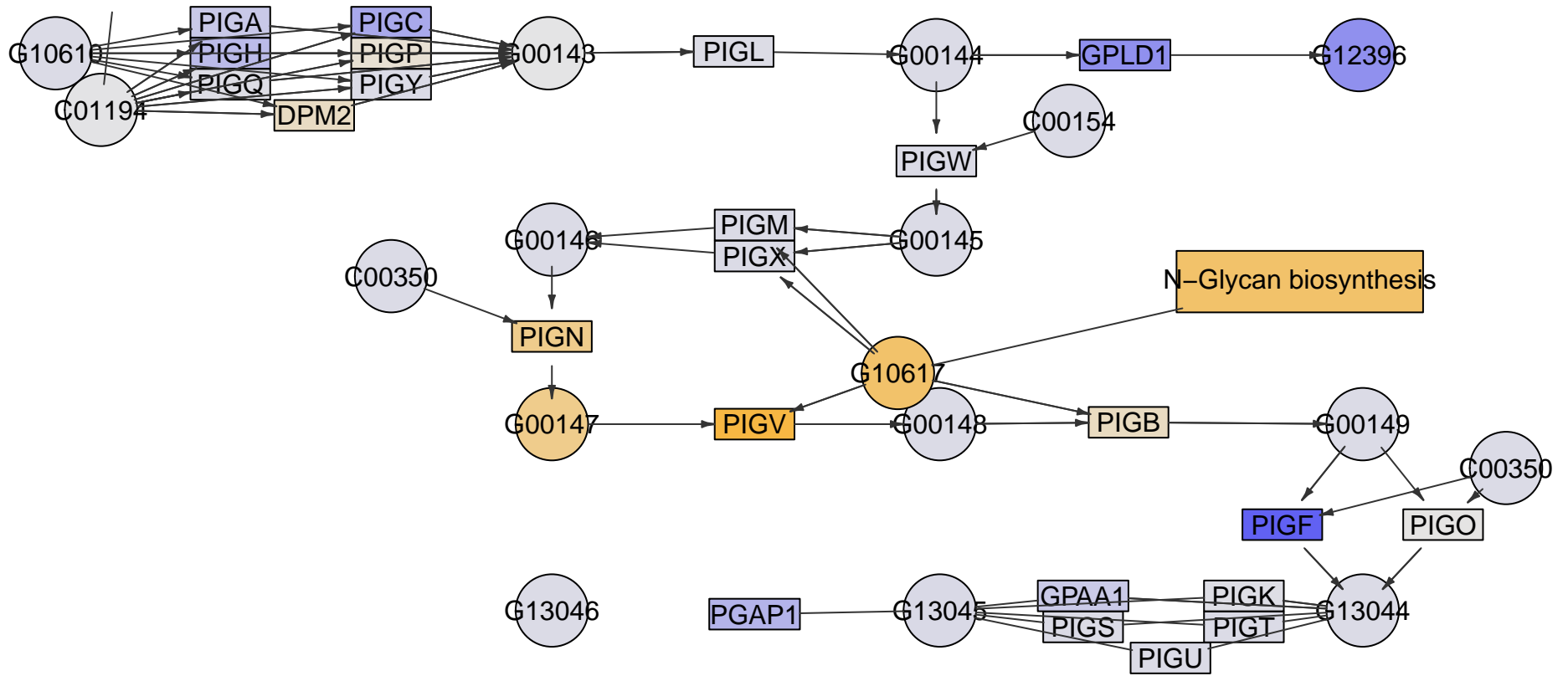

PIGK

PIGO

PIGG

PIGN

PIGZ

PIGB

PIGV

PIGM

PIGA

Glycosylphosphatidylinositol(GPI)-anchor
biosynthesis
MPI-129

Glycerophospholipid
metabolism

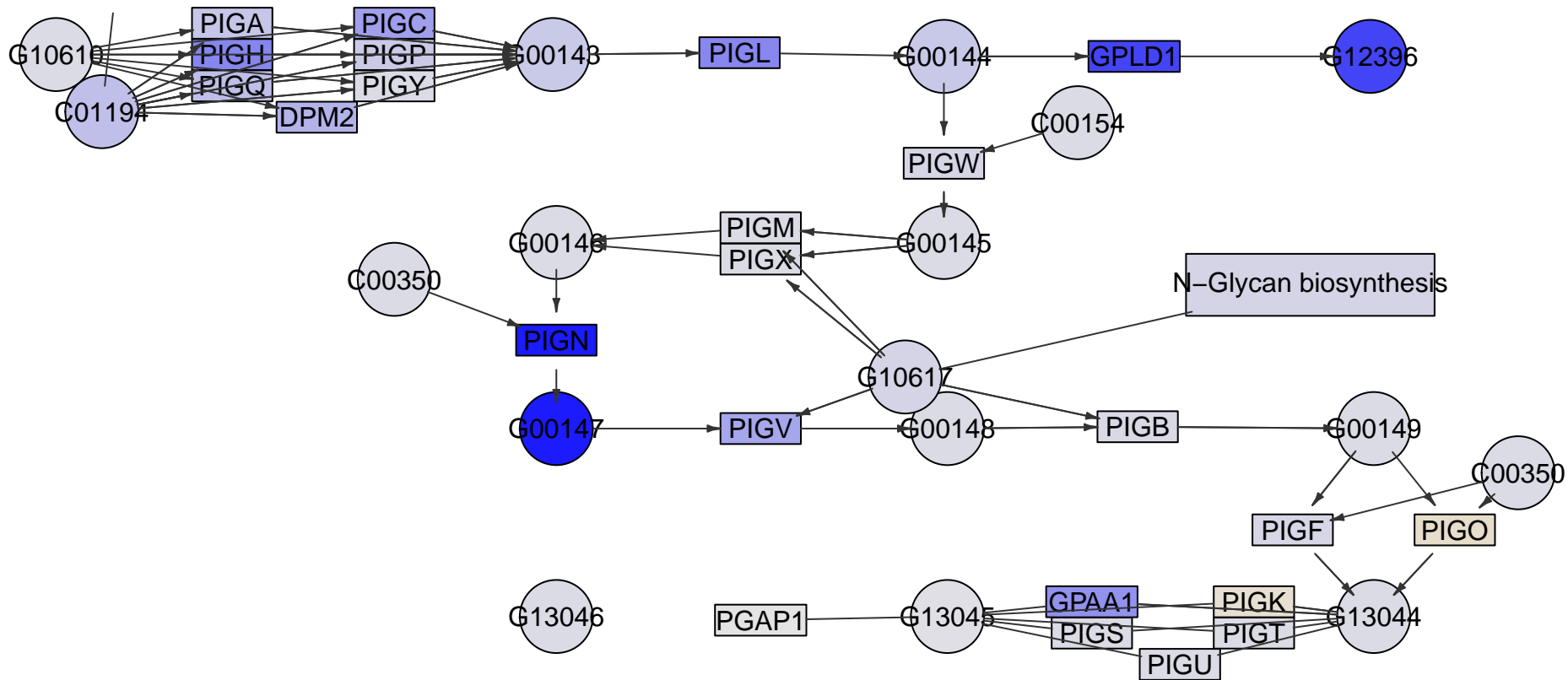

PIGK

PIGO

PIGG

PIGN

PIGZ

PIGB

PIGV

PIGM

PIGA

Glycosylphosphatidylinositol(GPI)-anchor
biosynthesis
MPI-130

Glycerophospholipid
metabolism

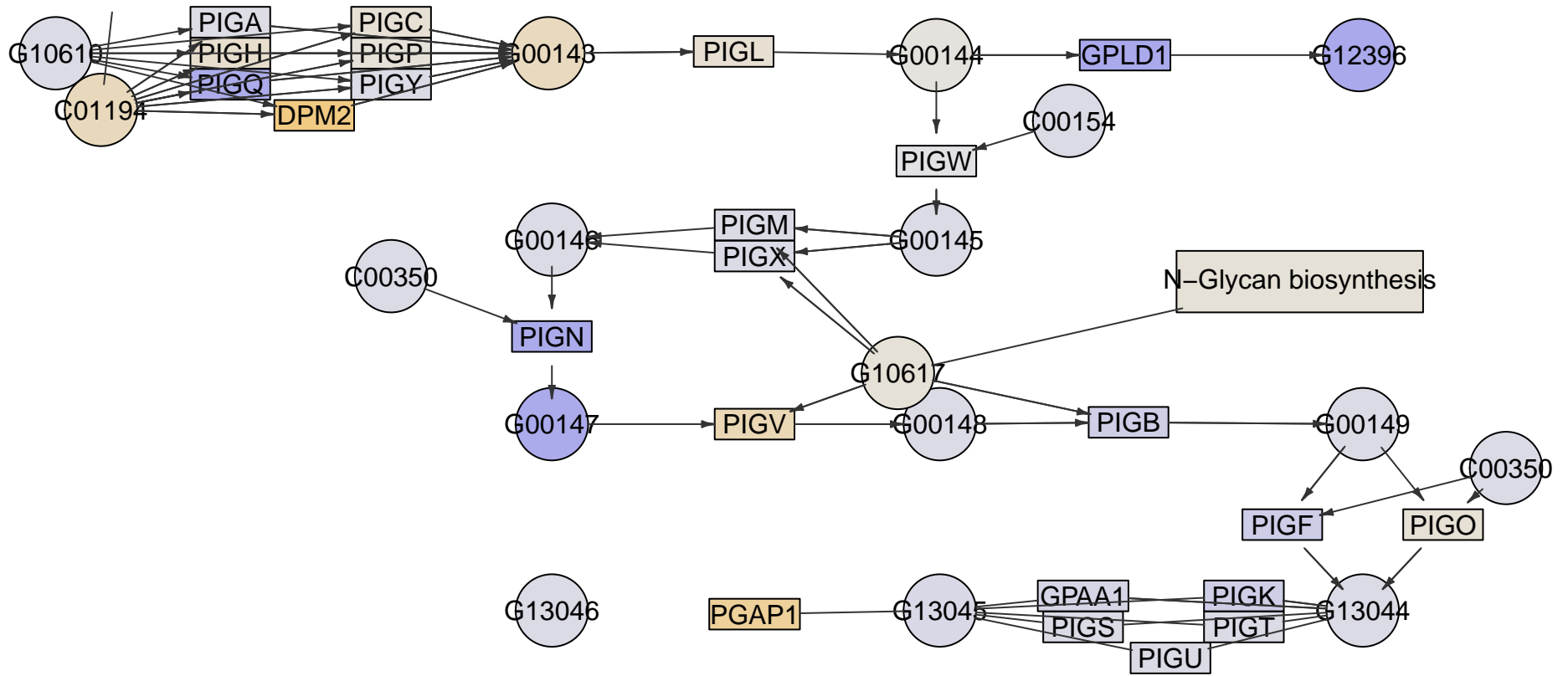

PIGK

PIGO

PIGG

PIGN

PIGZ

PIGB

PIGV

PIGM

PIGA

Glycosylphosphatidylinositol(GPI)-anchor
biosynthesis
MPI-132

Glycerophospholipid
metabolism

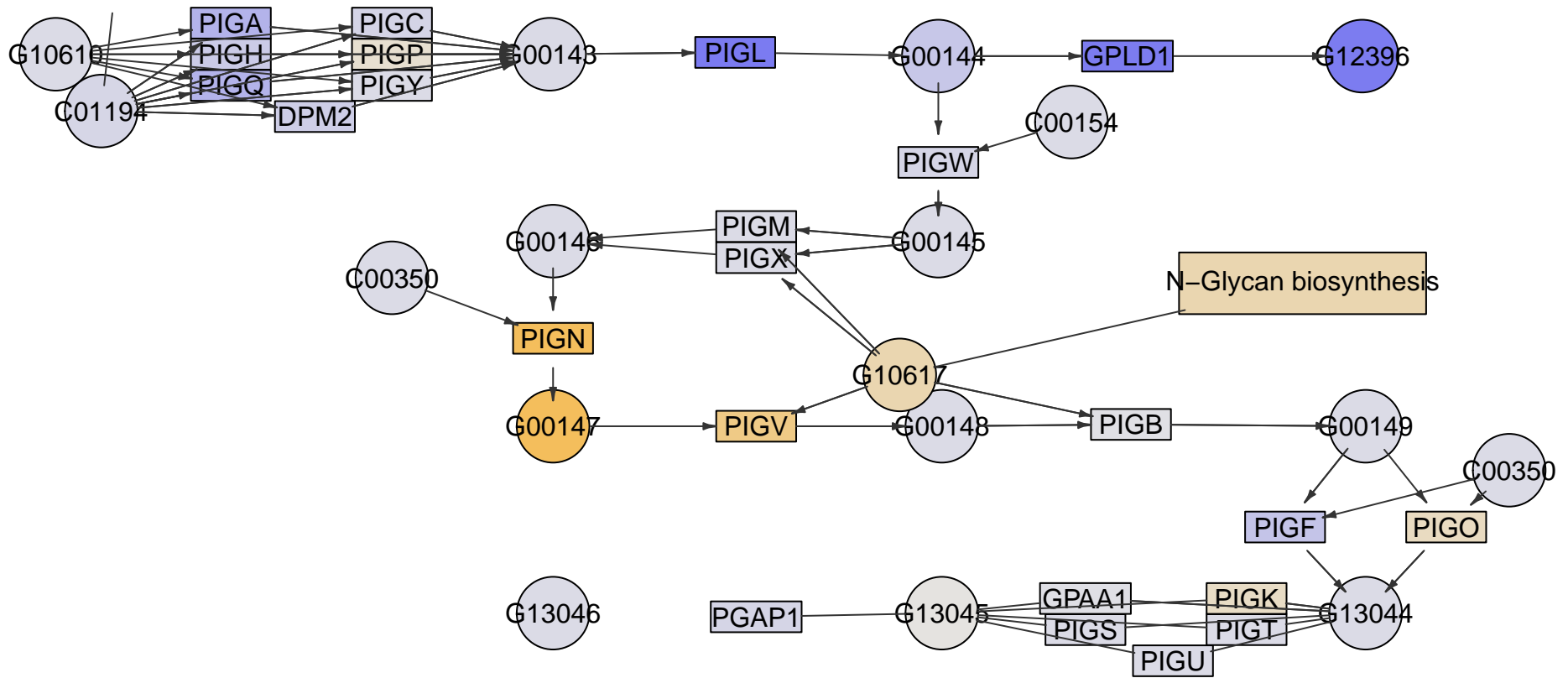

N-Glycan biosynthesis

PIGK

PIGO

PIGG

PIGN

PIGZ

PIGB

PIGV

PIGM

PIGA

Glycosylphosphatidylinositol(GPI)-anchor
biosynthesis
MPI-133

Glycerophospholipid
metabolism

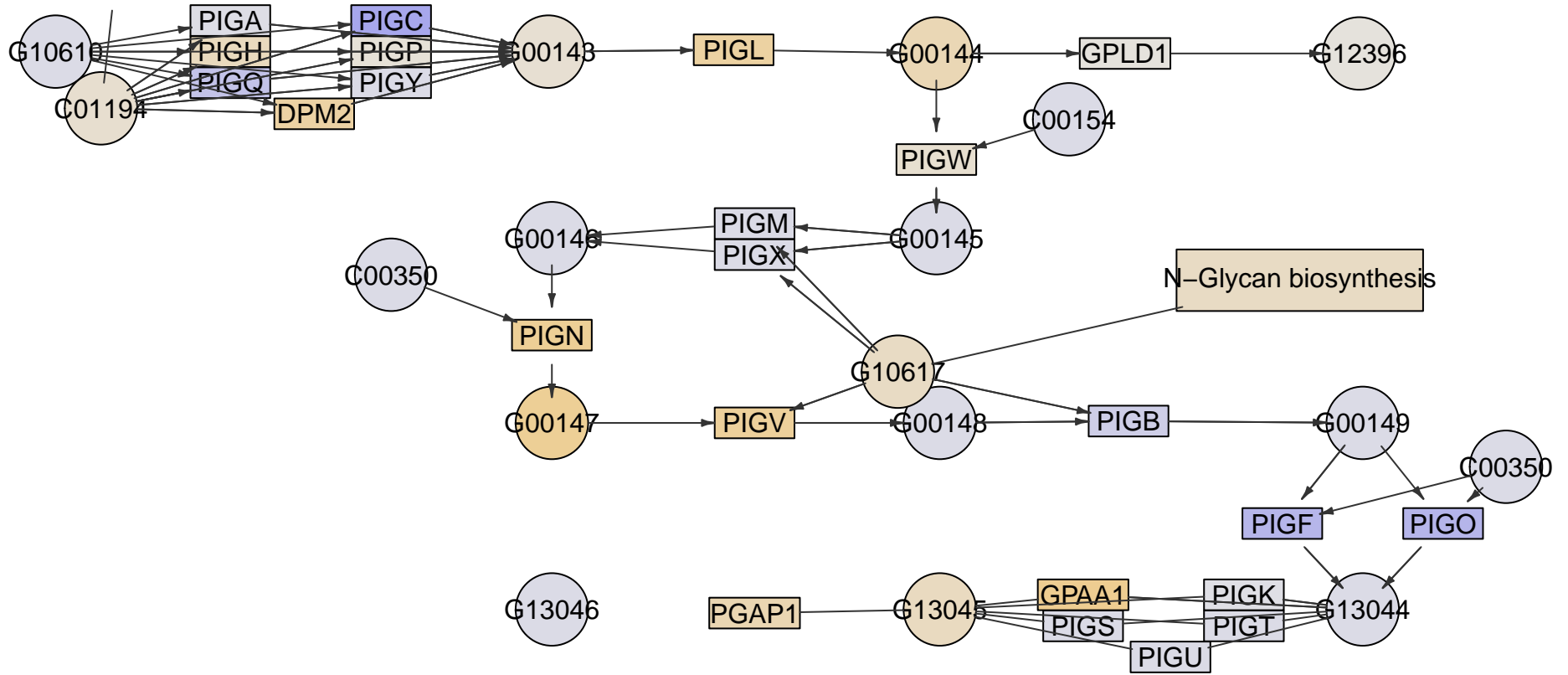

PIGK

PIGO

PIGG

PIGN

PIGZ

PIGB

PIGV

PIGM

PIGA

Glycosylphosphatidylinositol(GPI)-anchor
biosynthesis
MPI-134

Glycerophospholipid
metabolism

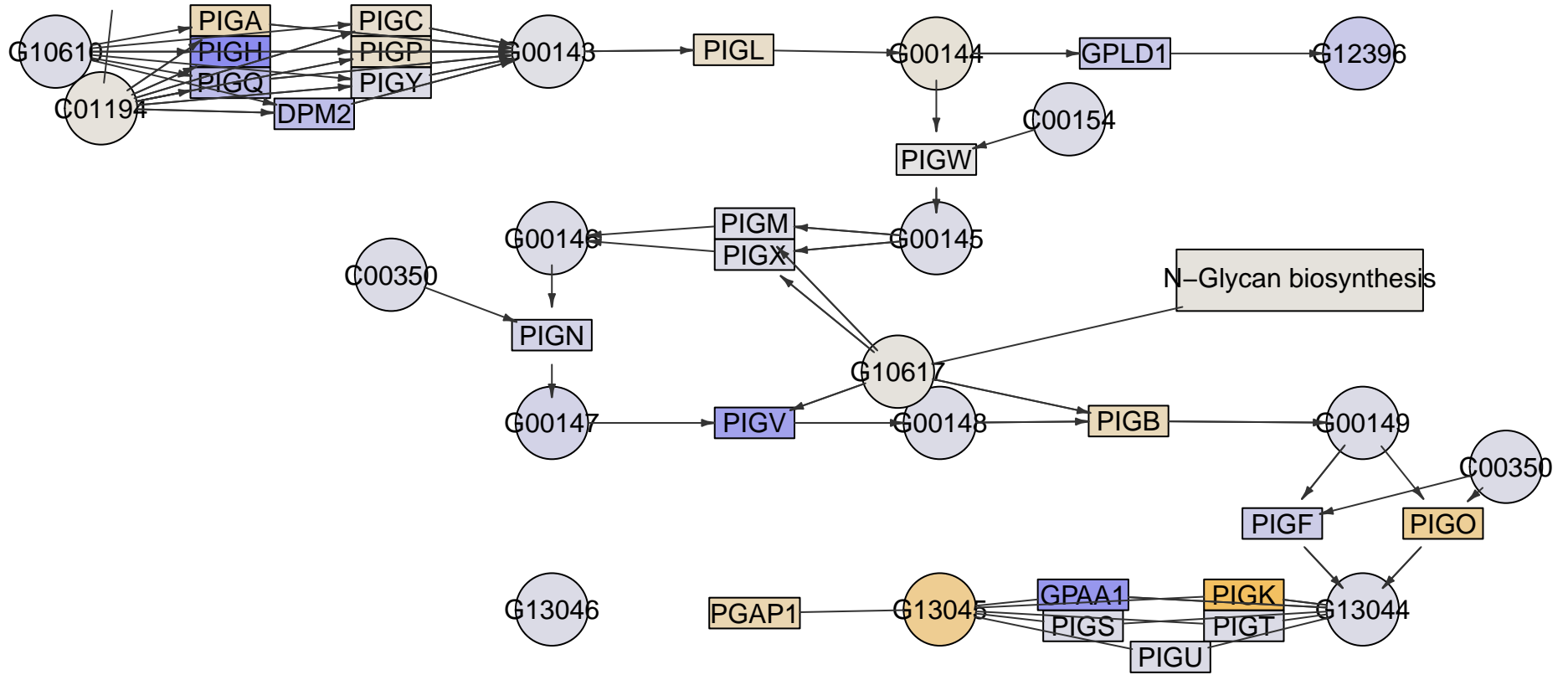

N-Glycan biosynthesis

PIGK

PIGO

PIGG

PIGN

PIGZ

PIGB

PIGV

PIGM

PIGA

Glycosylphosphatidylinositol(GPI)-anchor
biosynthesis
MPI-135

Glycerophospholipid
metabolism

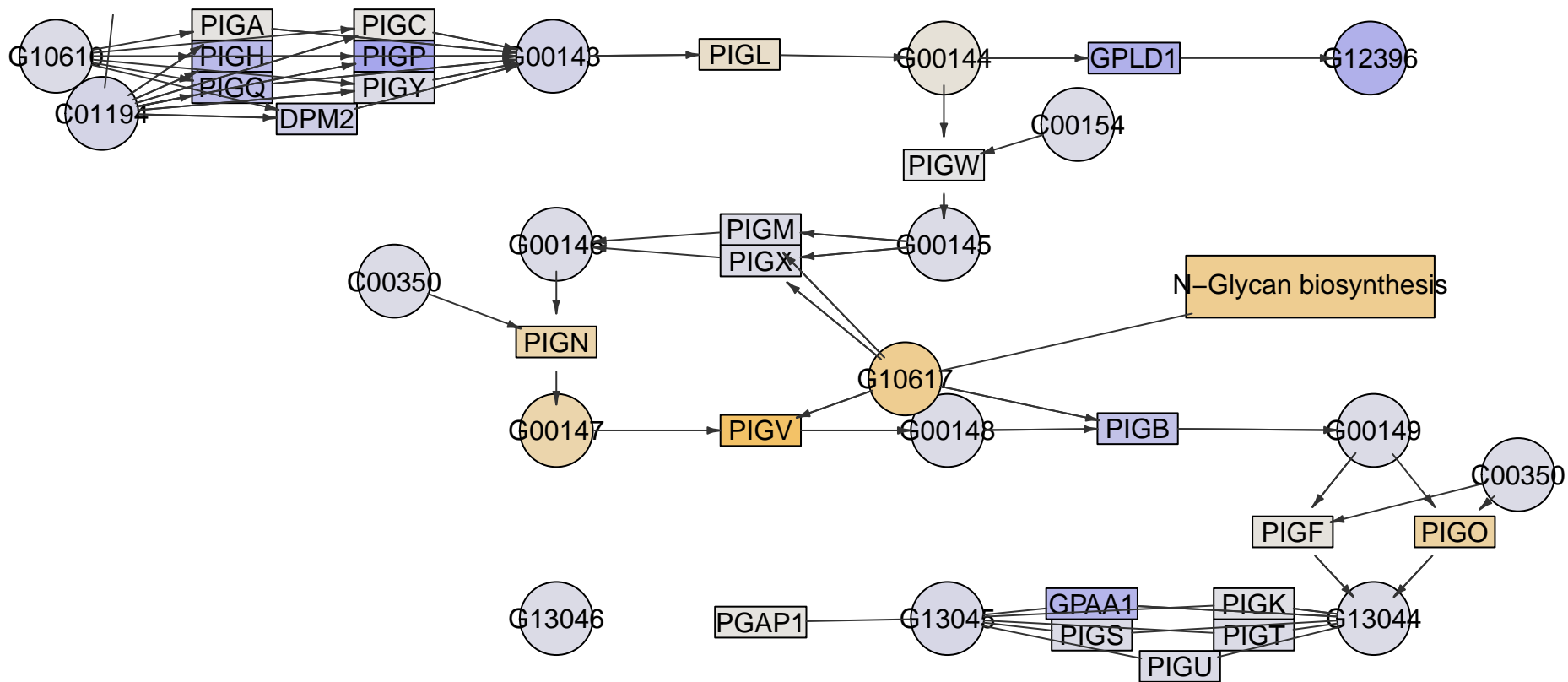

PIGK

PIGO

PIGG

PIGN

PIGZ

PIGB

PIGV

PIGM

PIGA

Glycosylphosphatidylinositol(GPI)-anchor
biosynthesis
MPI-136

Glycerophospholipid
metabolism

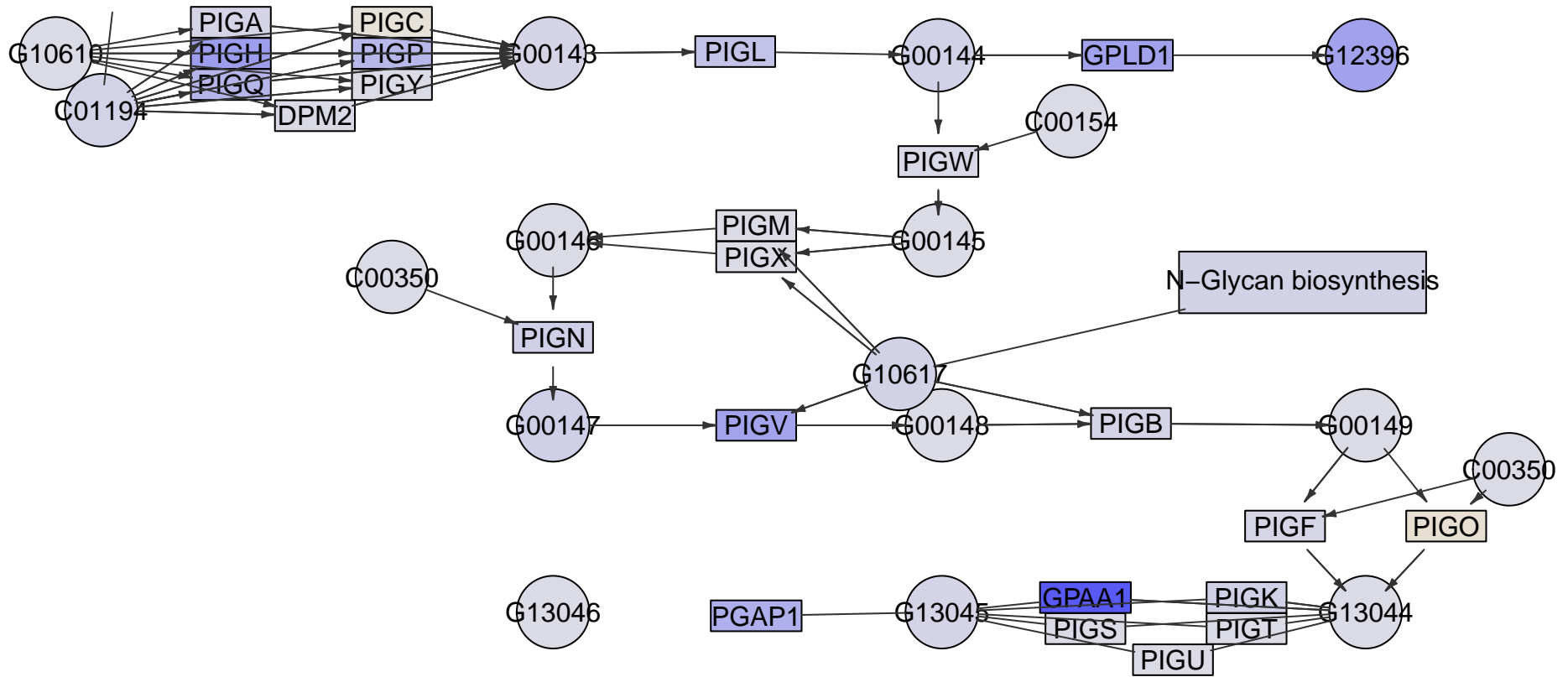

N-Glycan biosynthesis

PIGK

PIGO

PIGG

PIGN

PIGZ

PIGB

PIGV

PIGM

PIGA

Glycosylphosphatidylinositol(GPI)-anchor
biosynthesis
MPI-141

Glycerophospholipid
metabolism

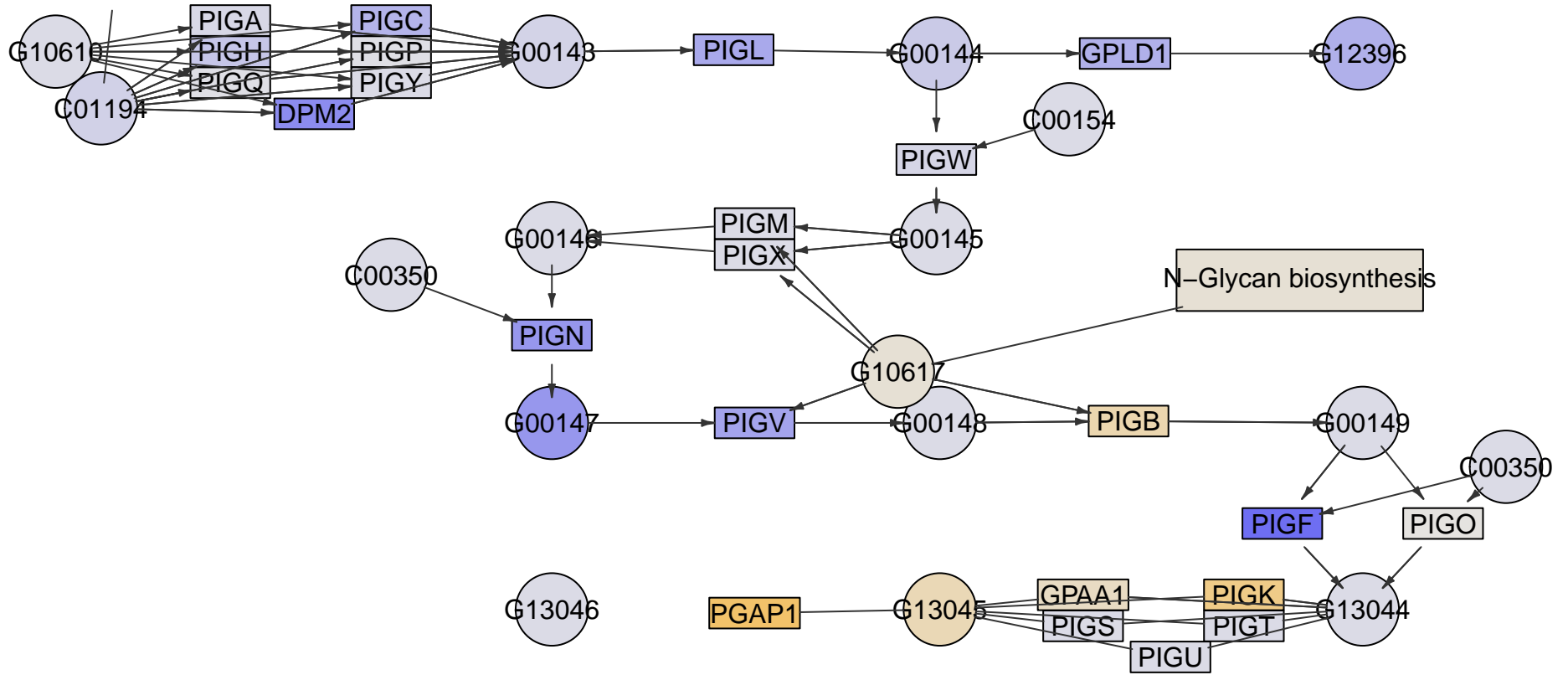

PIGK

PIGO

PIGG

PIGN

PIGZ

PIGB

PIGV

PIGM

PIGA

Glycosylphosphatidylinositol(GPI)-anchor
biosynthesis
MPI-142

Glycerophospholipid
metabolism

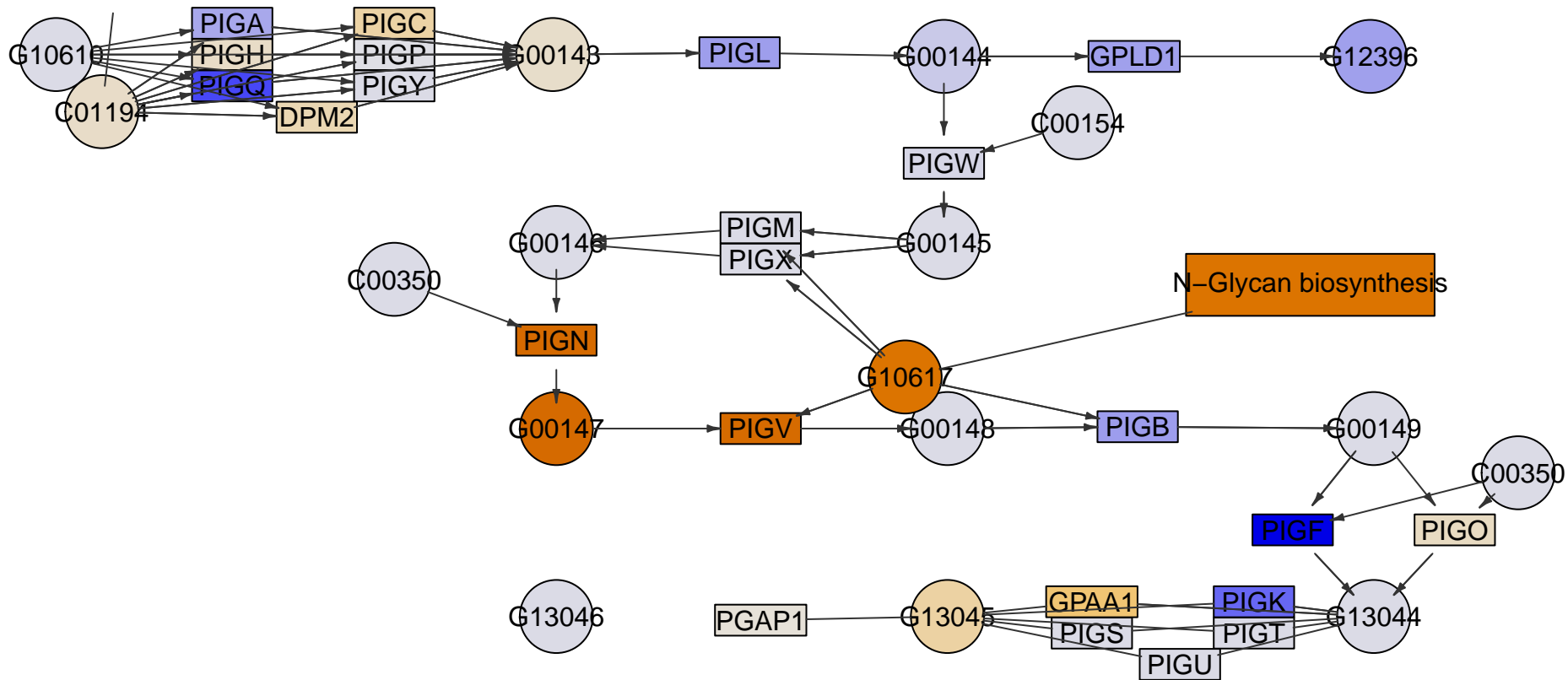

PIGK

PIGO

PIGG

PIGN

PIGZ

PIGB

PIGV

PIGM

PIGA

Glycosylphosphatidylinositol(GPI)-anchor
biosynthesis
MPI-145

Glycerophospholipid
metabolism

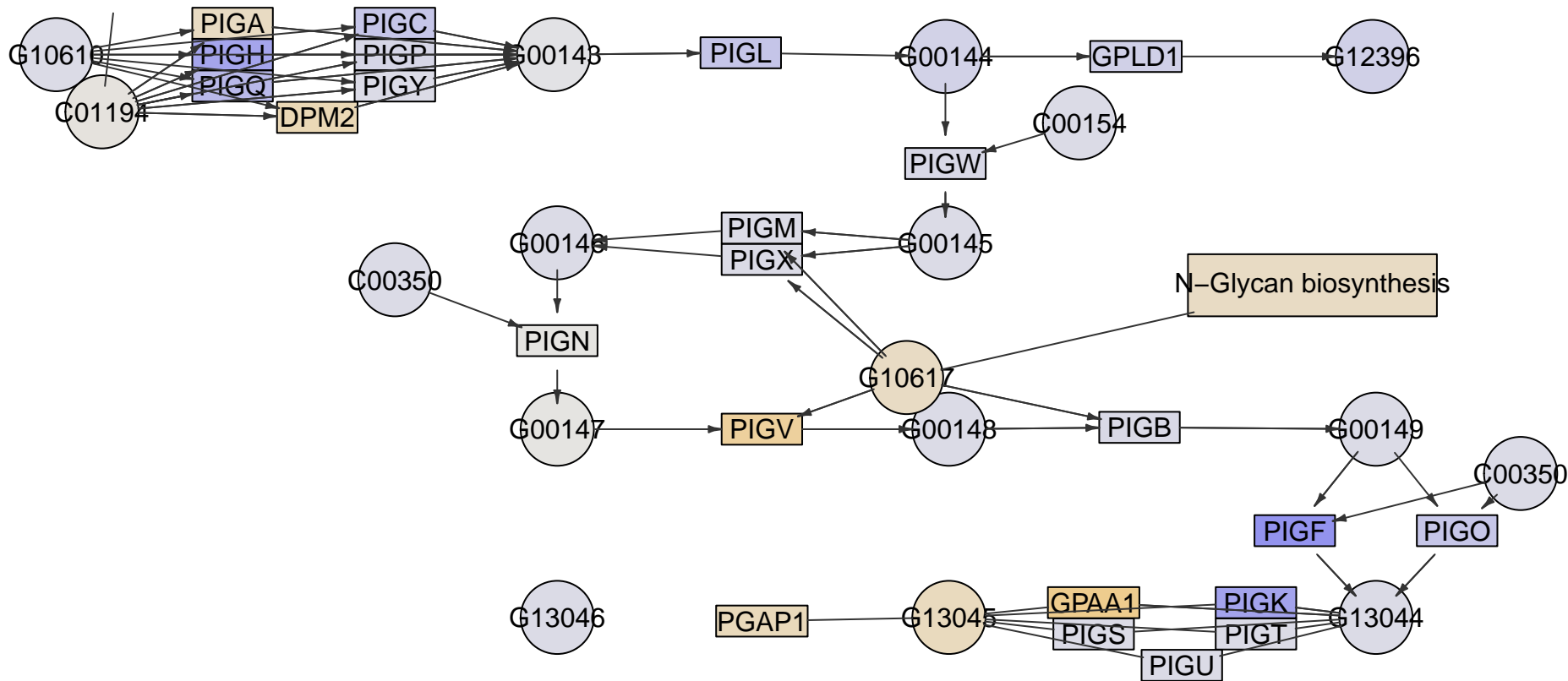

PIGK

PIGO

PIGG

PIGN

PIGZ

PIGB

PIGV

PIGM

PIGA

Glycosylphosphatidylinositol(GPI)-anchor
biosynthesis
MPI-146

Glycerophospholipid
metabolism

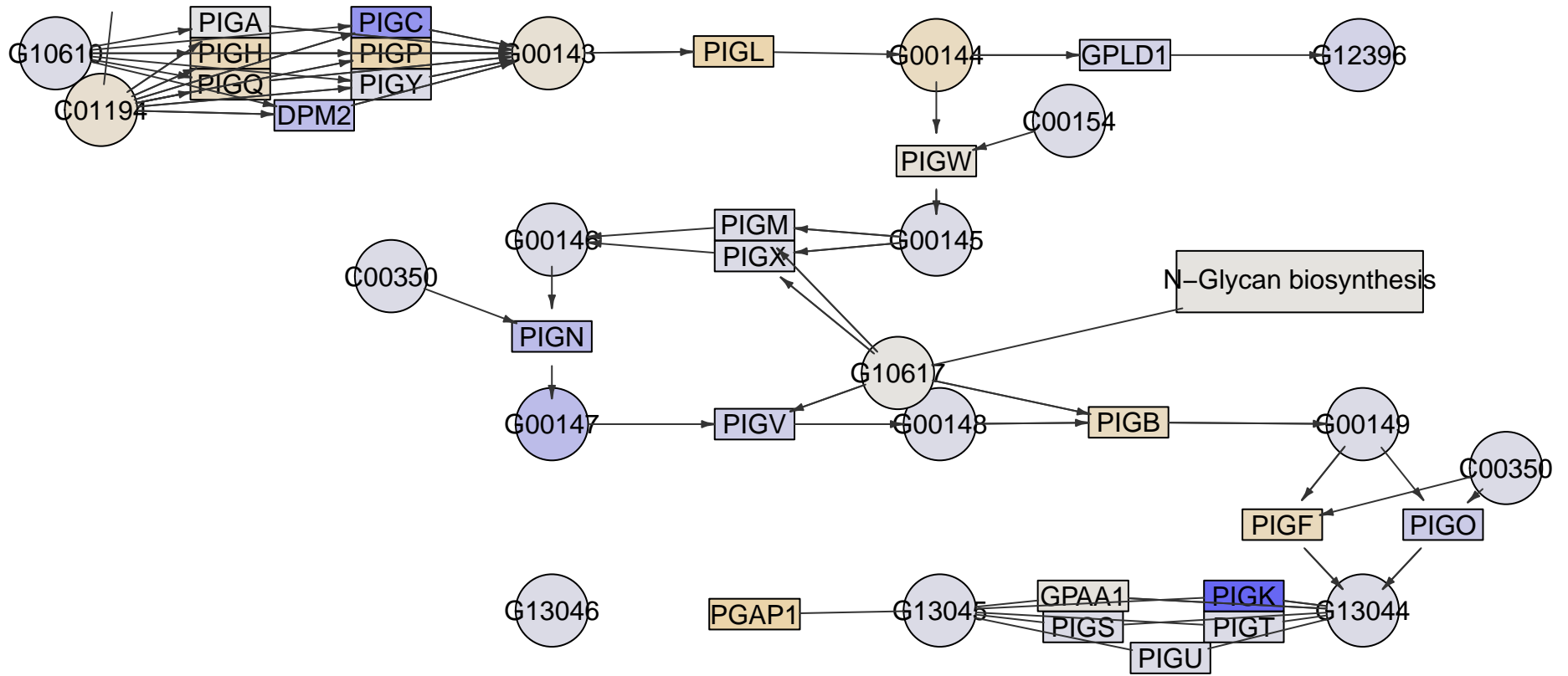

PIGK

PIGO

PIGG

PIGN

PIGZ

PIGB

PIGV

PIGM

PIGA

Glycosylphosphatidylinositol(GPI)-anchor
biosynthesis
MPI-149

Glycerophospholipid
metabolism

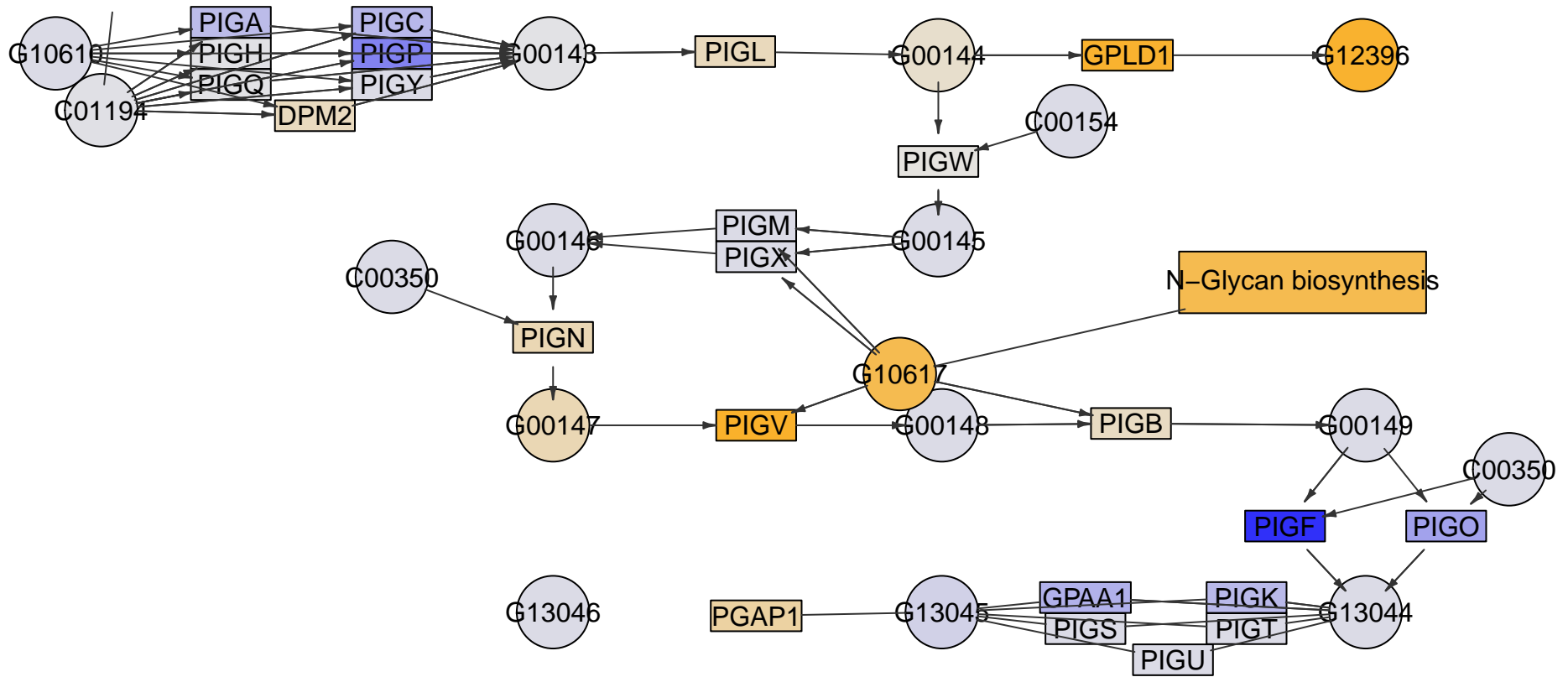

N-Glycan biosynthesis

PIGK

PIGO

PIGG

PIGN

PIGZ

PIGB

PIGV

PIGM

PIGA

Glycosylphosphatidylinositol(GPI)-anchor
biosynthesis
MPI-150

Glycerophospholipid
metabolism

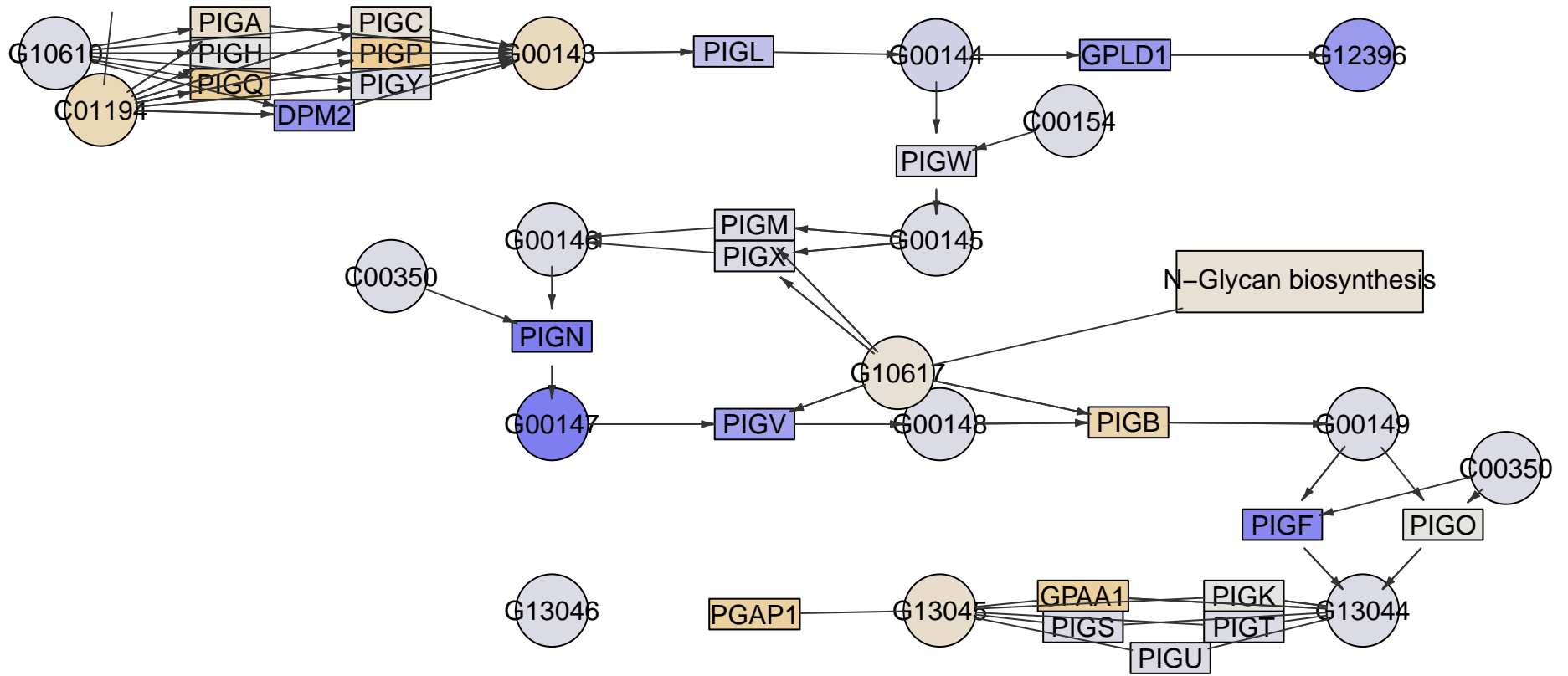

PIGK

PIGO

PIGG

PIGN

PIGZ

PIGB

PIGV

PIGM

PIGA

Glycosylphosphatidylinositol(GPI)-anchor
biosynthesis
MPI-151

Glycerophospholipid
metabolism

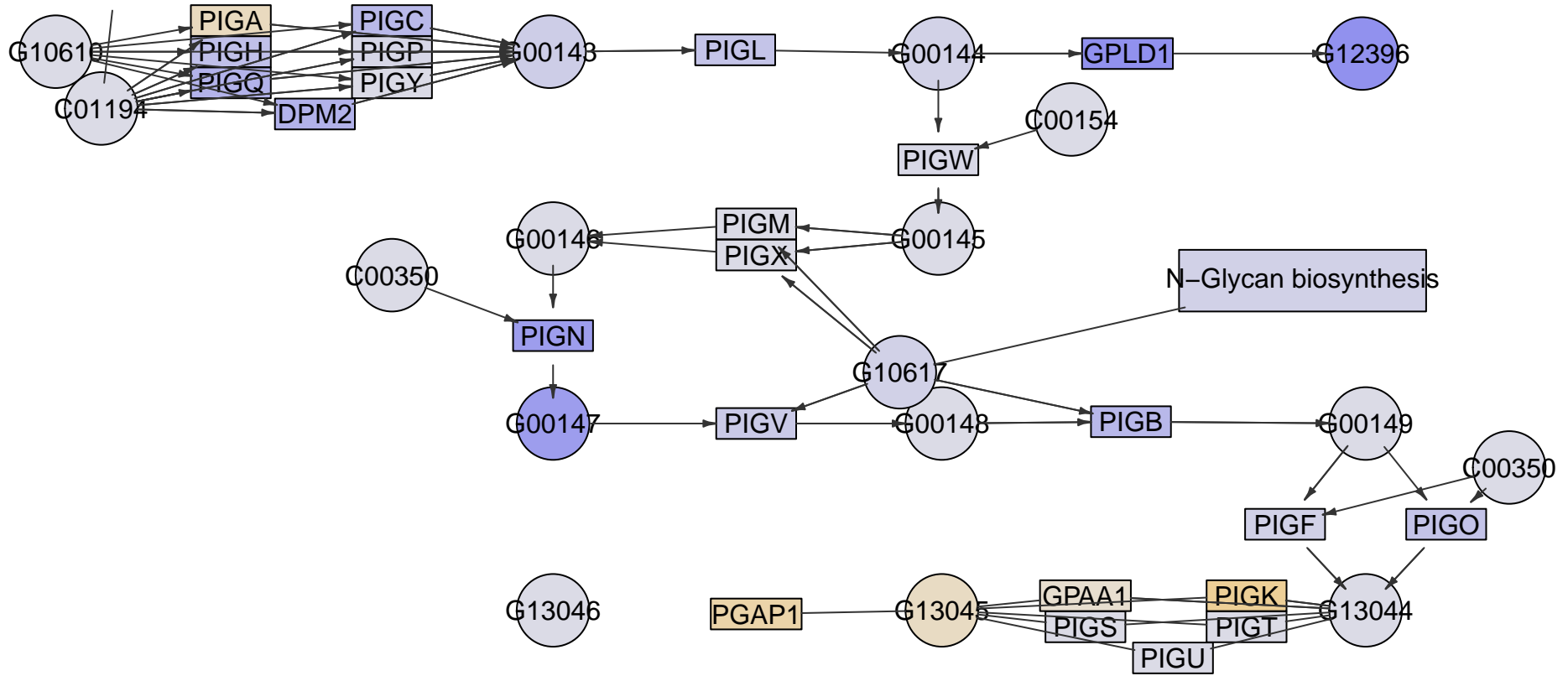

PIGK

PIGO

PIGG

PIGN

PIGZ

PIGB

PIGV

PIGM

PIGA

Glycosylphosphatidylinositol(GPI)-anchor
biosynthesis
MPI-152

Glycerophospholipid
metabolism

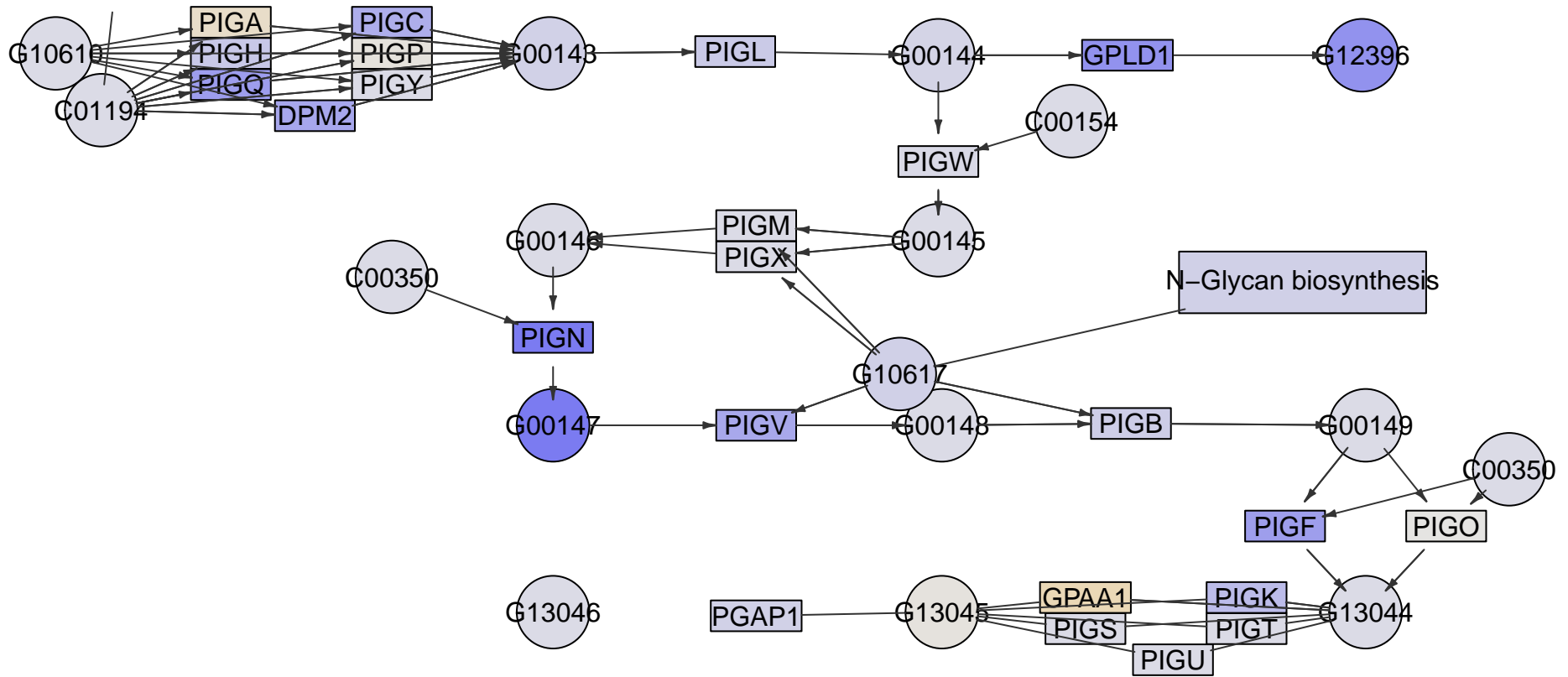

N-Glycan biosynthesis

PIGK

PIGO

PIGG

PIGN

PIGZ

PIGB

PIGV

PIGM

PIGA

Glycosylphosphatidylinositol(GPI)-anchor
biosynthesis
MPI-153

Glycerophospholipid
metabolism

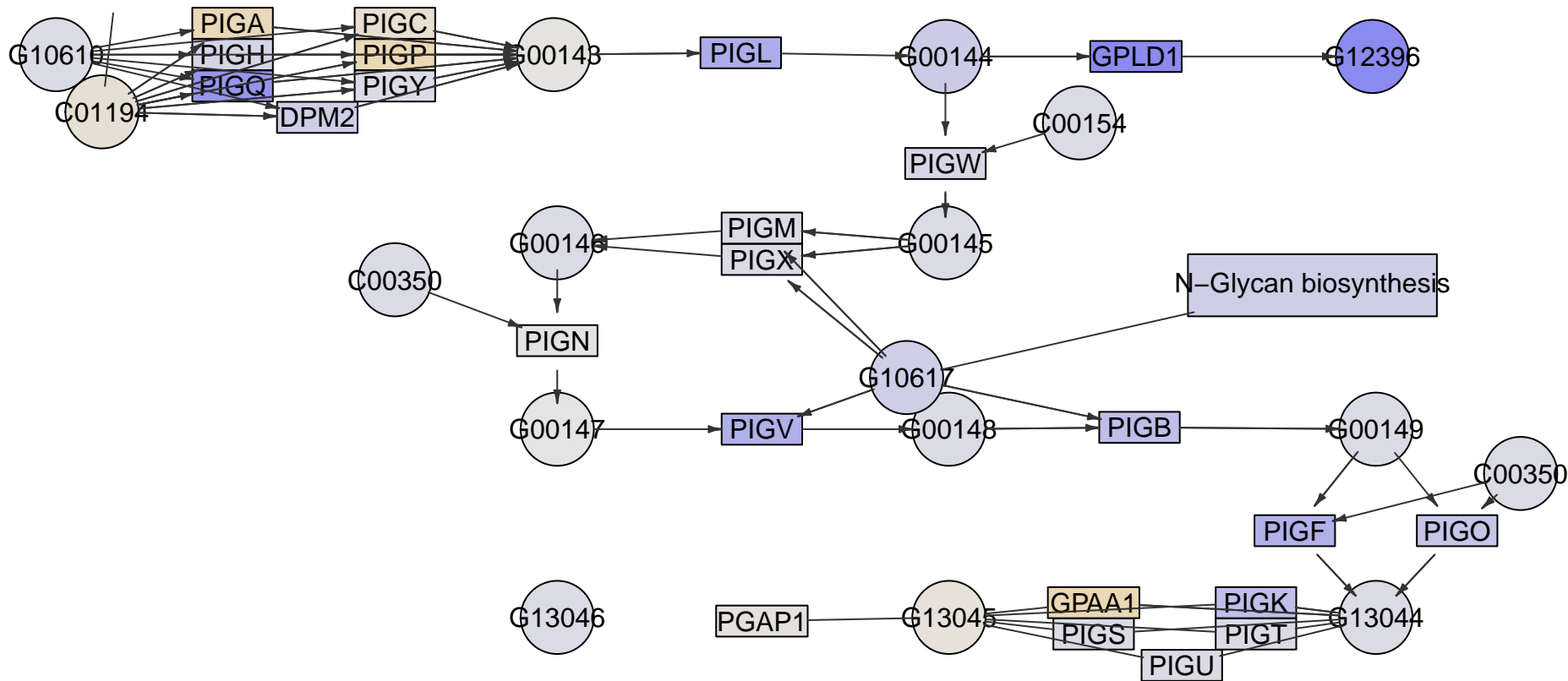

PIGK

PIGO

PIGG

PIGN

PIGZ

PIGB

PIGV

PIGM

PIGA

Glycosylphosphatidylinositol(GPI)-anchor
biosynthesis
MPI-154

Glycerophospholipid
metabolism

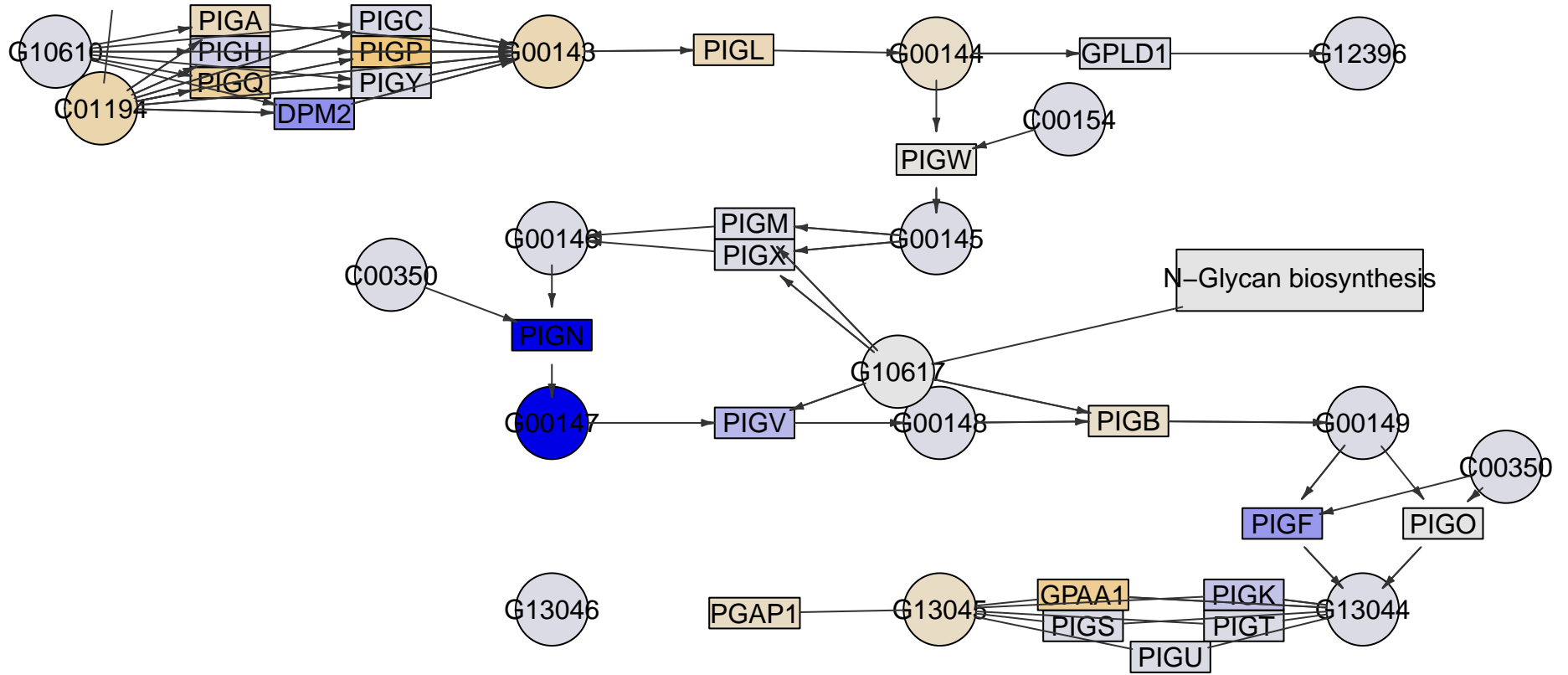

PIGK

PIGO

PIGG

PIGN

PIGZ

PIGB

PIGV

PIGM

PIGA

Glycosylphosphatidylinositol(GPI)-anchor
biosynthesis
MPI-155

Glycerophospholipid
metabolism

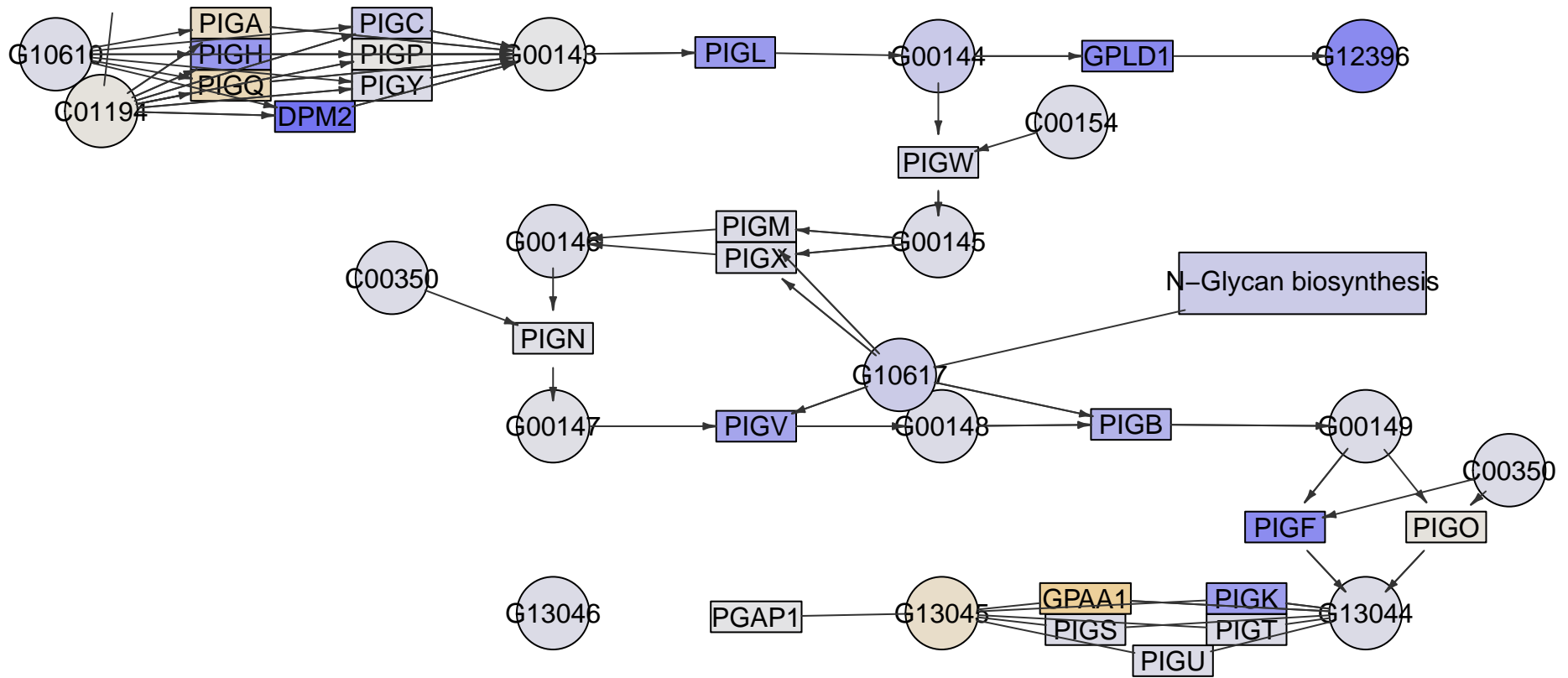

PIGK

PIGO

PIGG

PIGN

PIGZ

PIGB

PIGV

PIGM

PIGA

Glycosylphosphatidylinositol(GPI)-anchor
biosynthesis
MPI-159

Glycerophospholipid
metabolism

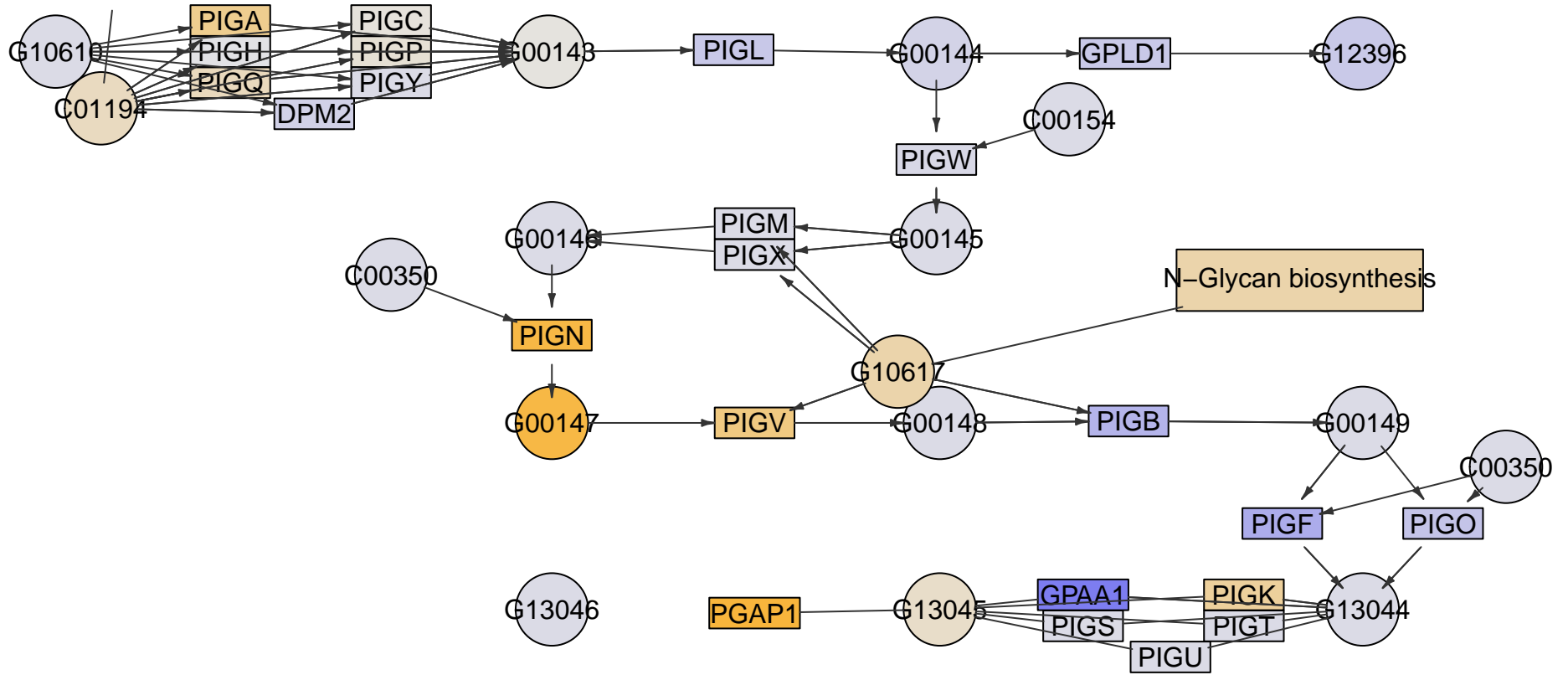

PIGK

PIGO

PIGG

PIGN

PIGZ

PIGB

PIGV

PIGM

PIGA

Glycosylphosphatidylinositol(GPI)-anchor
biosynthesis
MPI-163

Glycerophospholipid
metabolism

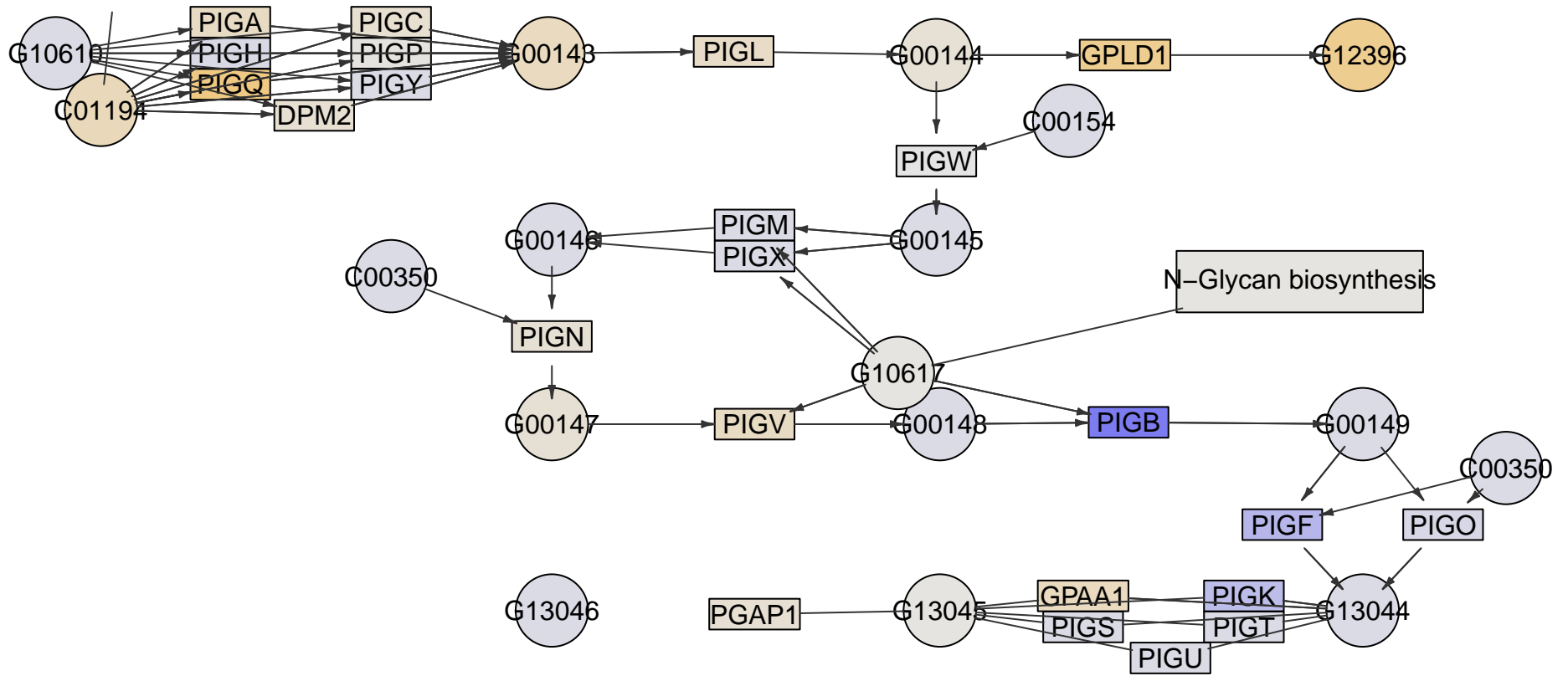

PIGK

PIGO

PIGG

PIGN

PIGZ

PIGB

PIGV

PIGM

PIGA

Glycosylphosphatidylinositol(GPI)-anchor
biosynthesis
MPI-164

Glycerophospholipid
metabolism

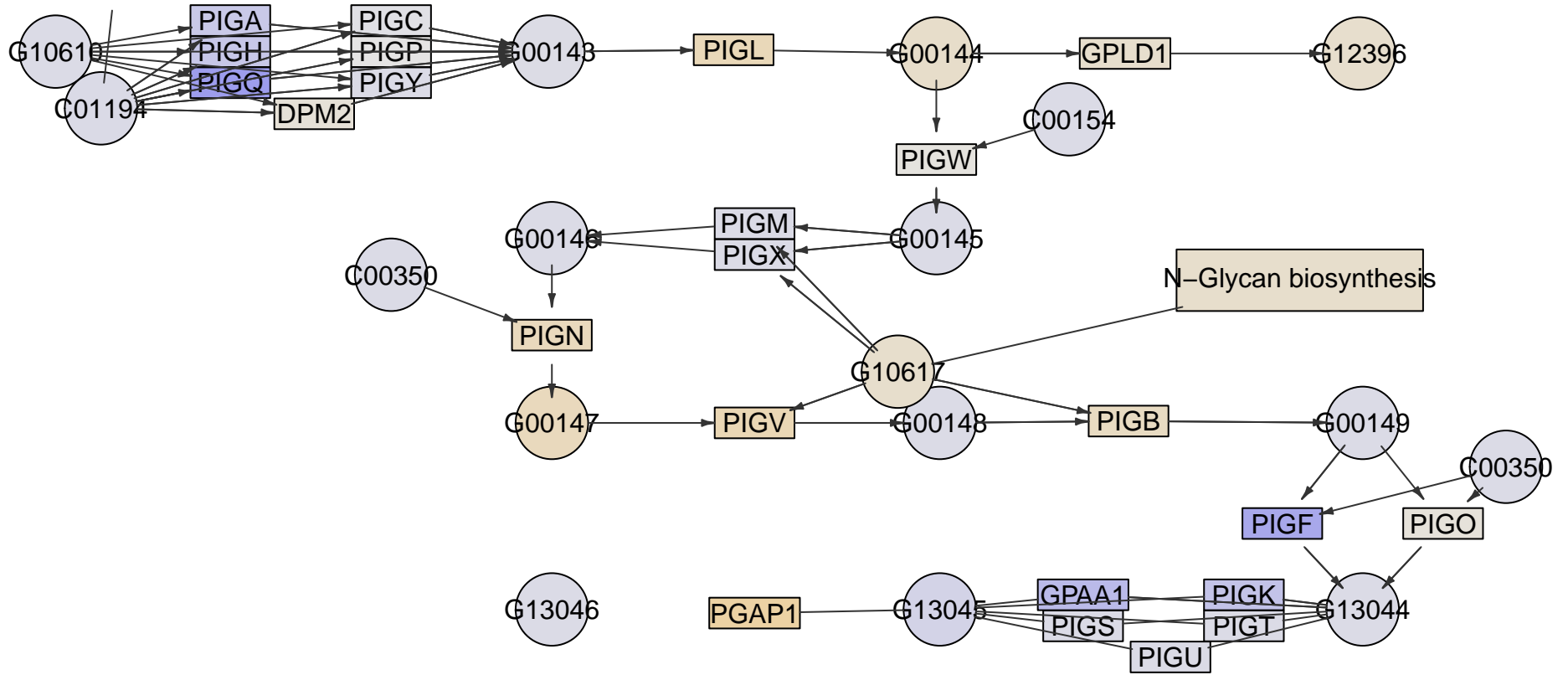

PIGK

PIGO

PIGG

PIGN

PIGZ

PIGB

PIGV

PIGM

PIGA

Glycosylphosphatidylinositol(GPI)-anchor
biosynthesis
MPI-166

Glycerophospholipid
metabolism

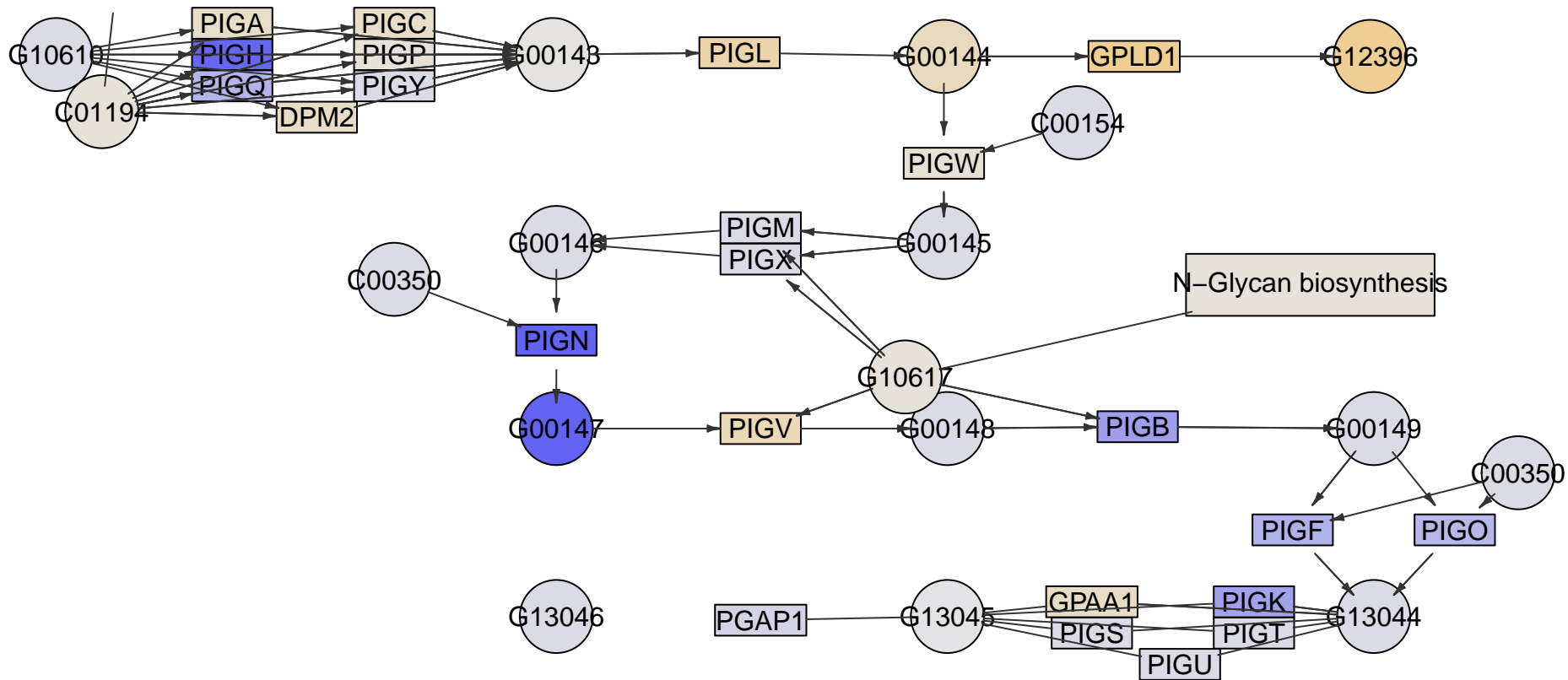

N-Glycan biosynthesis

PIGK

PIGO

PIGG

PIGN

PIGZ

PIGB

PIGV

PIGM

PIGA

Glycosylphosphatidylinositol(GPI)-anchor
biosynthesis
MPI-167

Glycerophospholipid
metabolism

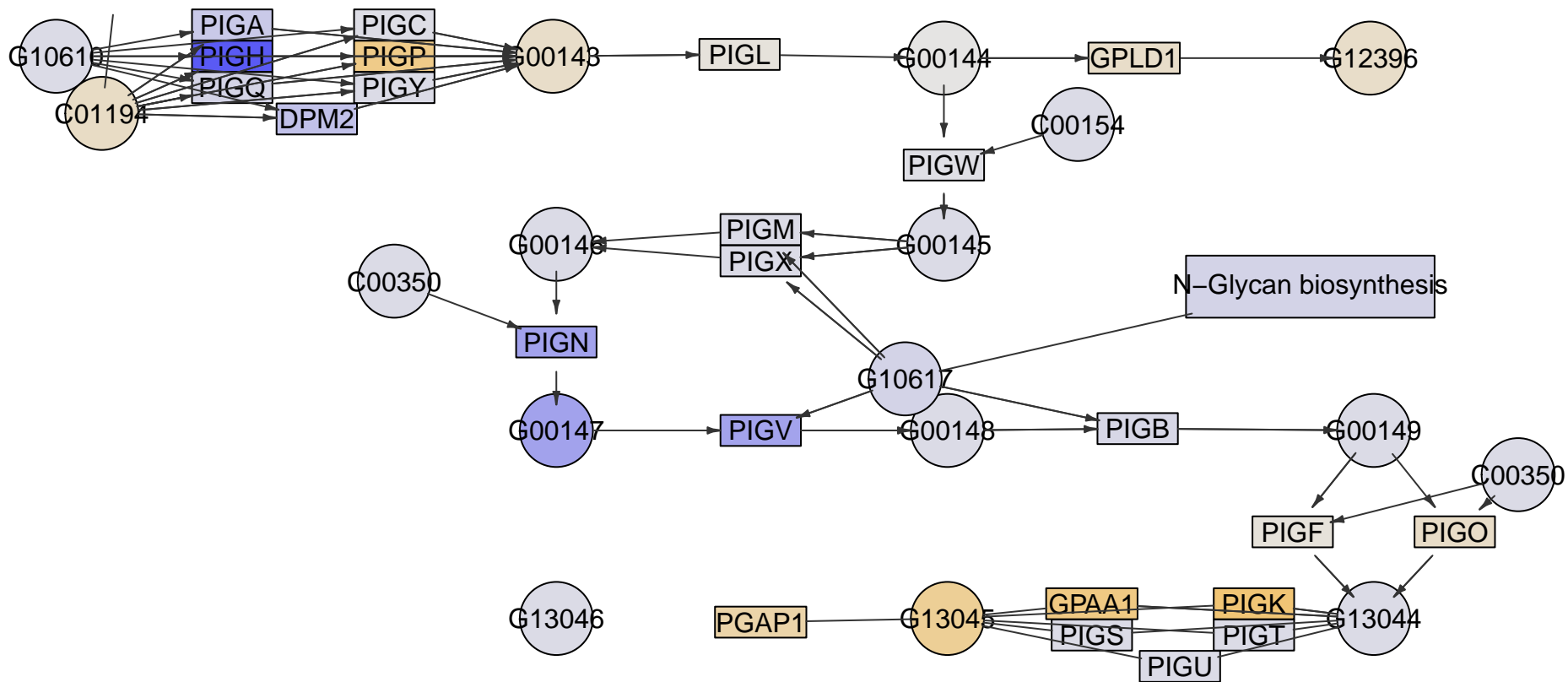

PIGK

PIGO

PIGG

PIGN

PIGZ

PIGB

PIGV

PIGM

PIGA

Glycosylphosphatidylinositol(GPI)-anchor
biosynthesis
MPI-168

Glycerophospholipid
metabolism

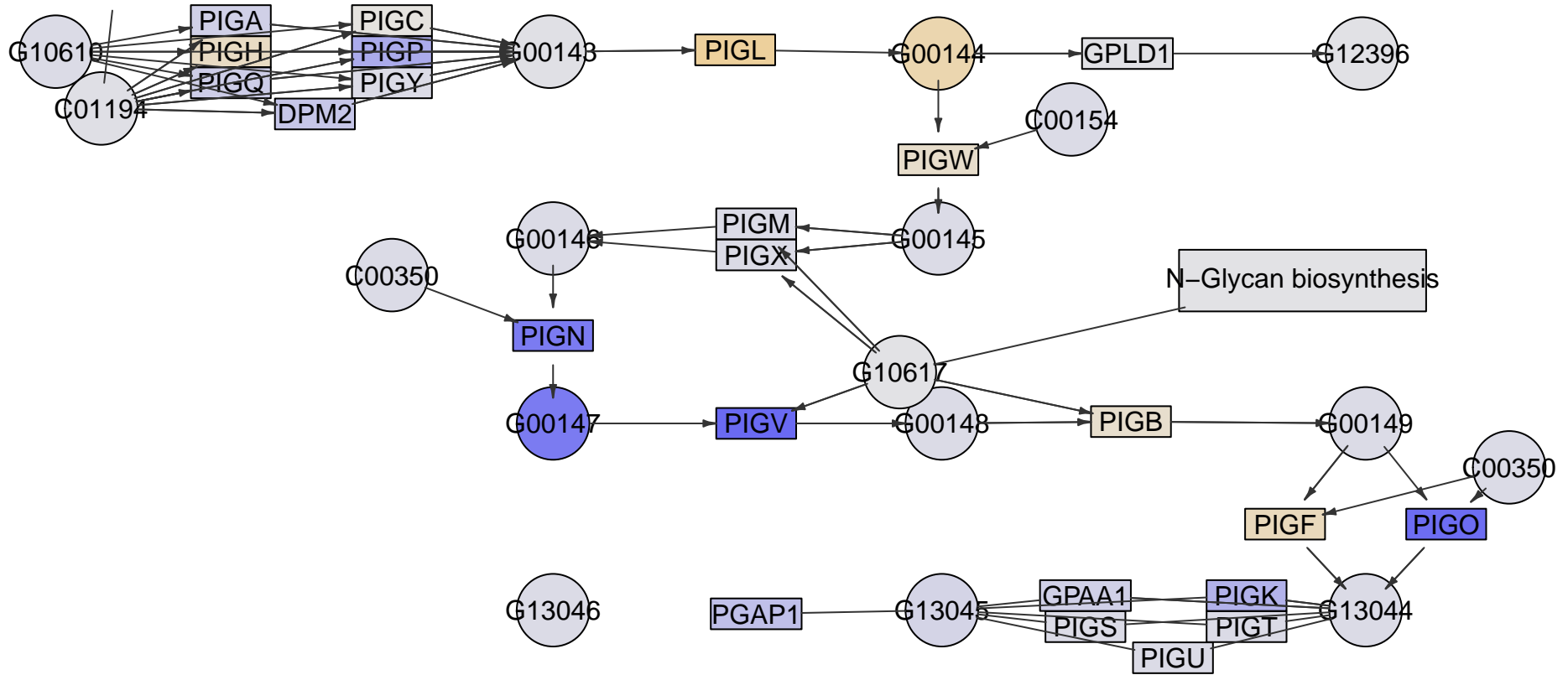

N-Glycan biosynthesis

PIGK

PIGO

PIGG

PIGN

PIGZ

PIGB

PIGV

PIGM

PIGA

Glycosylphosphatidylinositol(GPI)-anchor
biosynthesis
MPI-170

Glycerophospholipid
metabolism

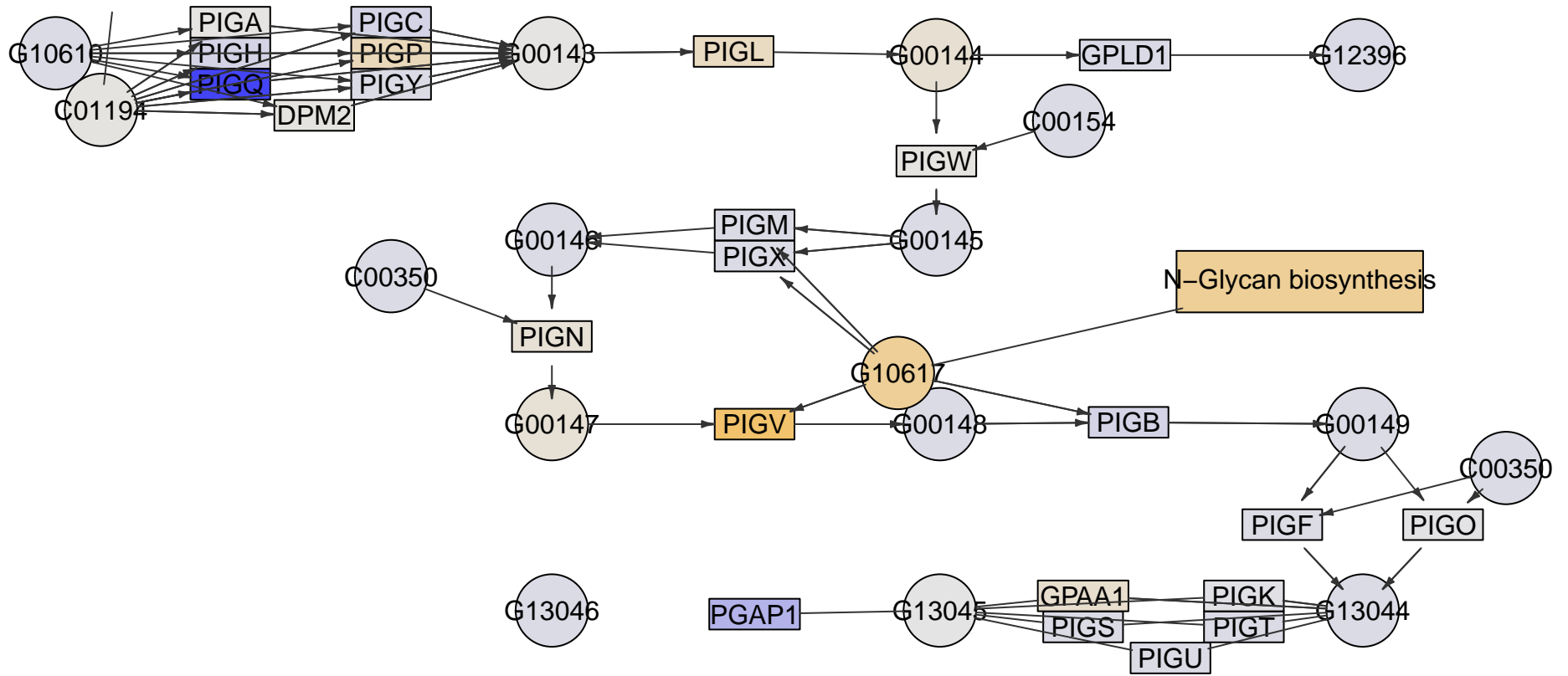

N-Glycan biosynthesis

PIGK

PIGO

PIGG

PIGN

PIGZ

PIGB

PIGV

PIGM

PIGA

Glycosylphosphatidylinositol(GPI)-anchor
biosynthesis
MPI-173

Glycerophospholipid
metabolism

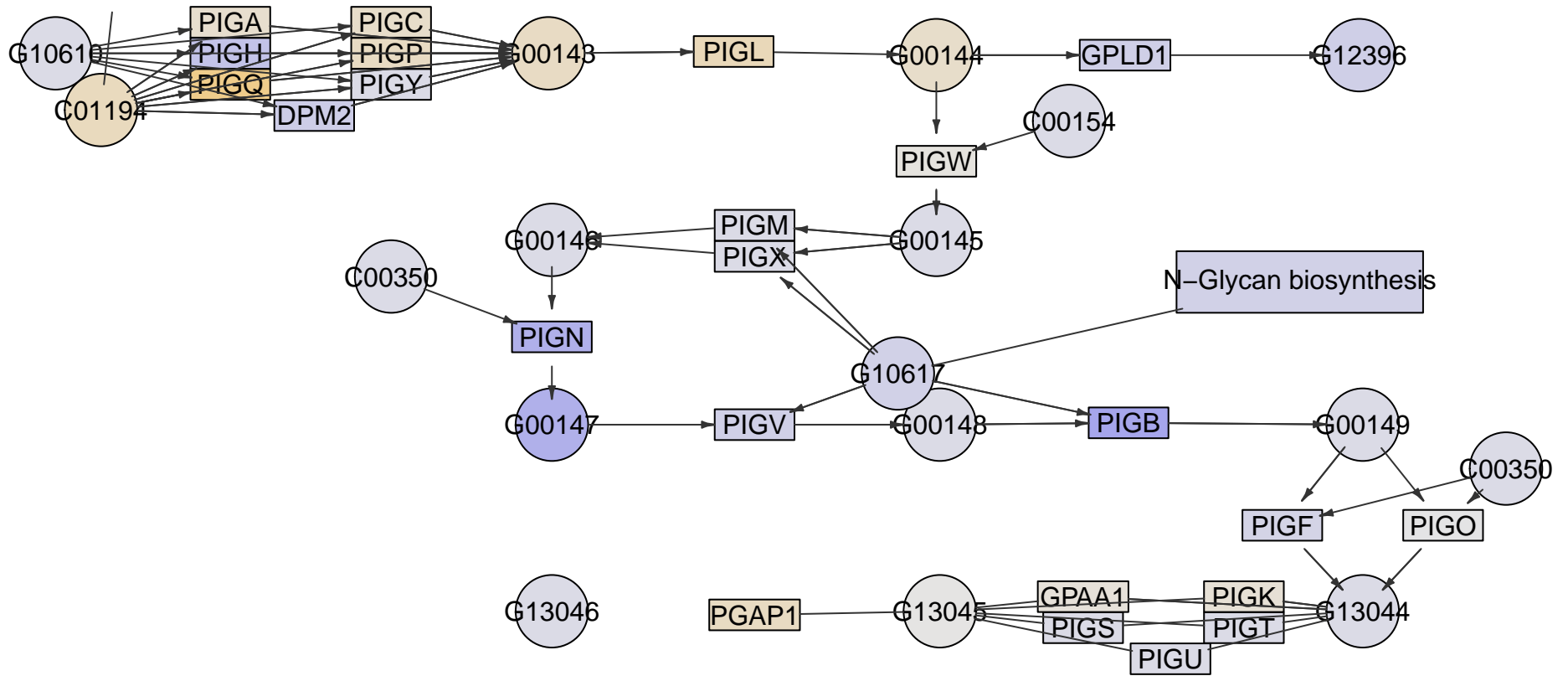

N-Glycan biosynthesis

PIGK

PIGO

PIGG

PIGN

PIGZ

PIGB

PIGV

PIGM

PIGA

Glycosylphosphatidylinositol(GPI)-anchor
biosynthesis
MPI-174

Glycerophospholipid
metabolism

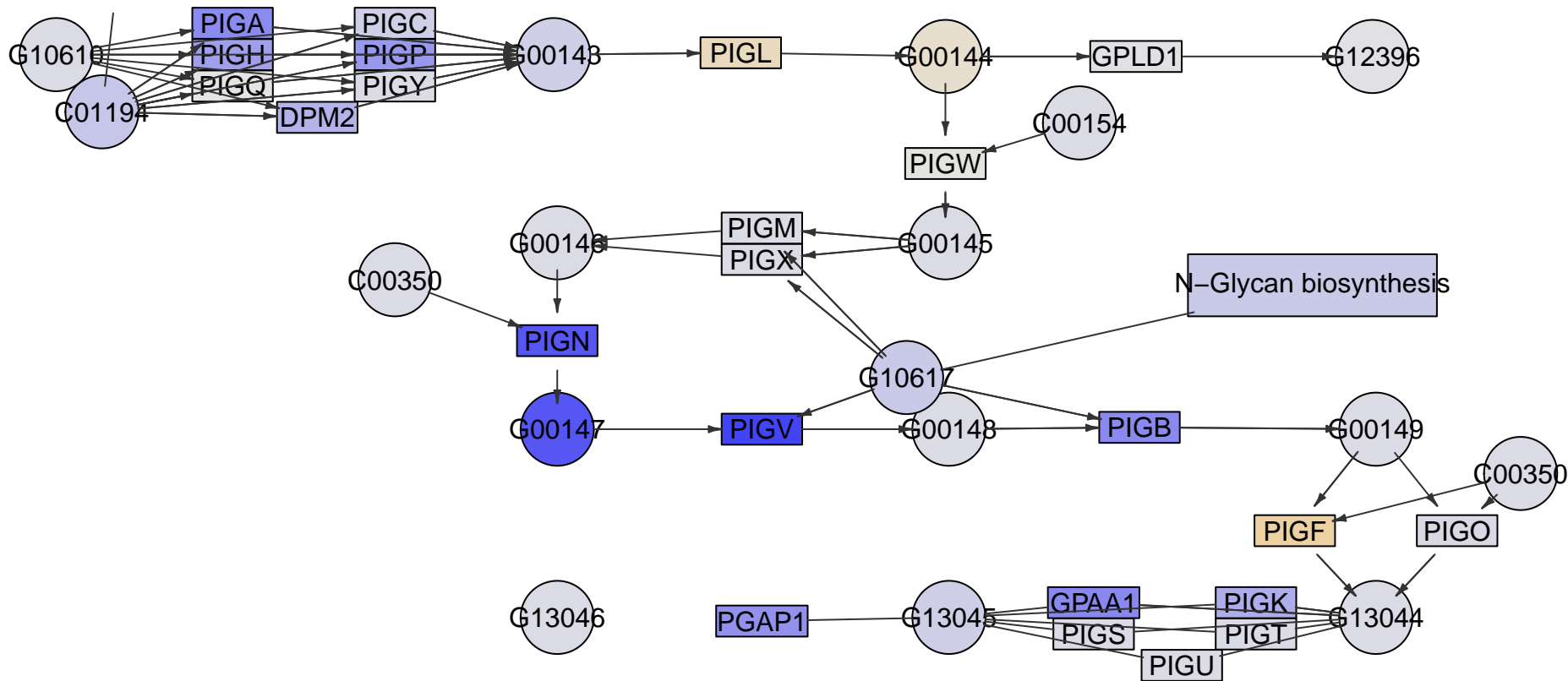

PIGK

PIGO

PIGG

PIGN

PIGZ

PIGB

PIGV

PIGM

PIGA

Glycosylphosphatidylinositol(GPI)-anchor
biosynthesis
MPI-176

Glycerophospholipid
metabolism

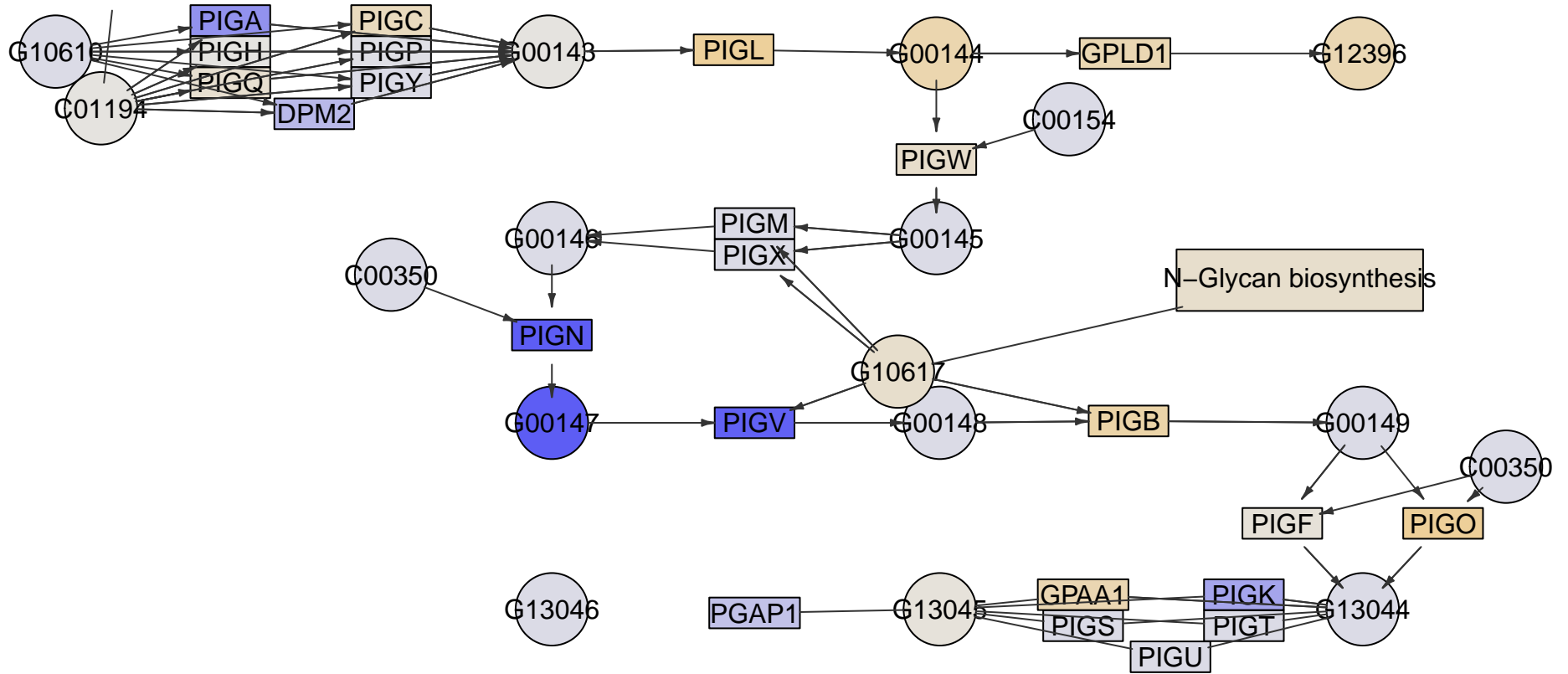

PIGK

PIGO

PIGG

PIGN

PIGZ

PIGB

PIGV

PIGM

PIGA

Glycosylphosphatidylinositol(GPI)-anchor
biosynthesis
MPI-177

Glycerophospholipid
metabolism

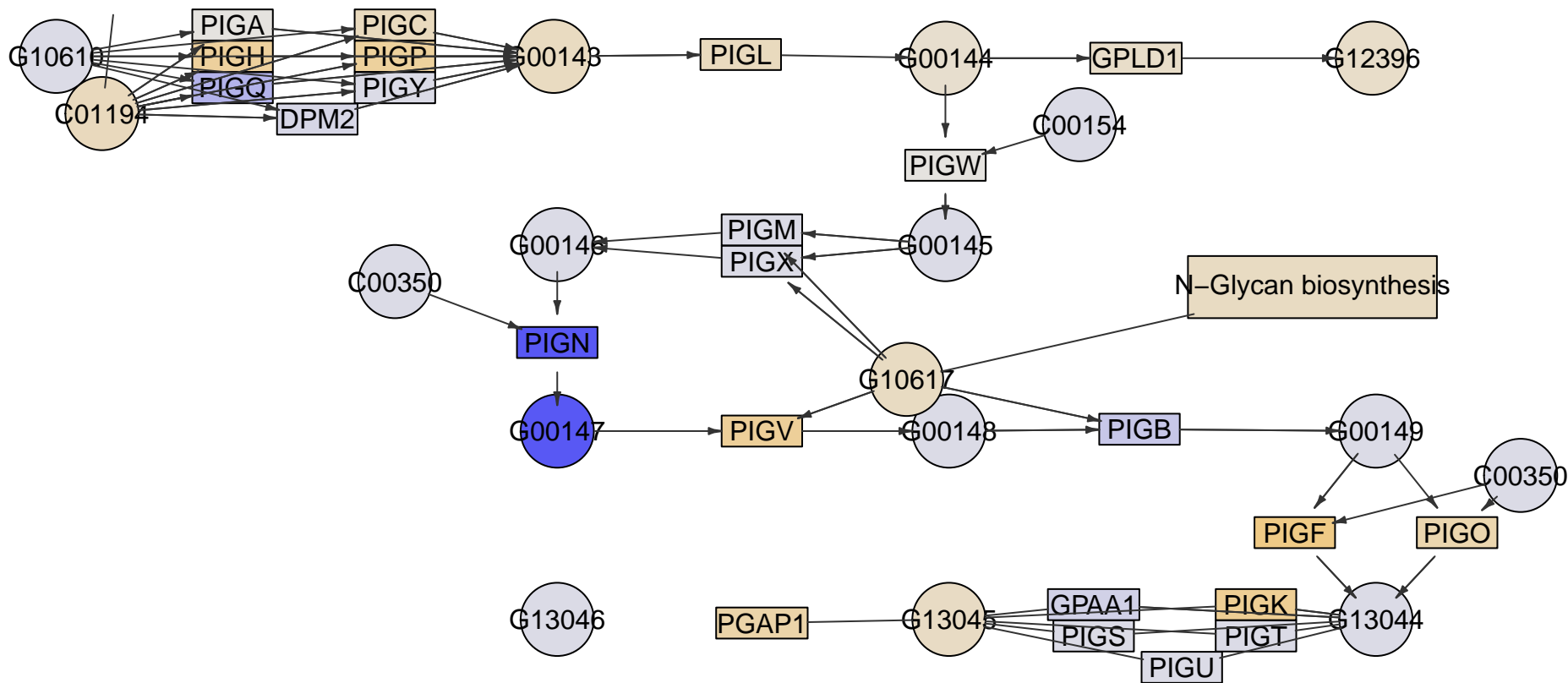

N-Glycan biosynthesis

PIGK

PIGO

PIGG

PIGN

PIGZ

PIGB

PIGV

PIGM

PIGA

Glycosylphosphatidylinositol(GPI)-anchor
biosynthesis
MPI-178

Glycerophospholipid
metabolism

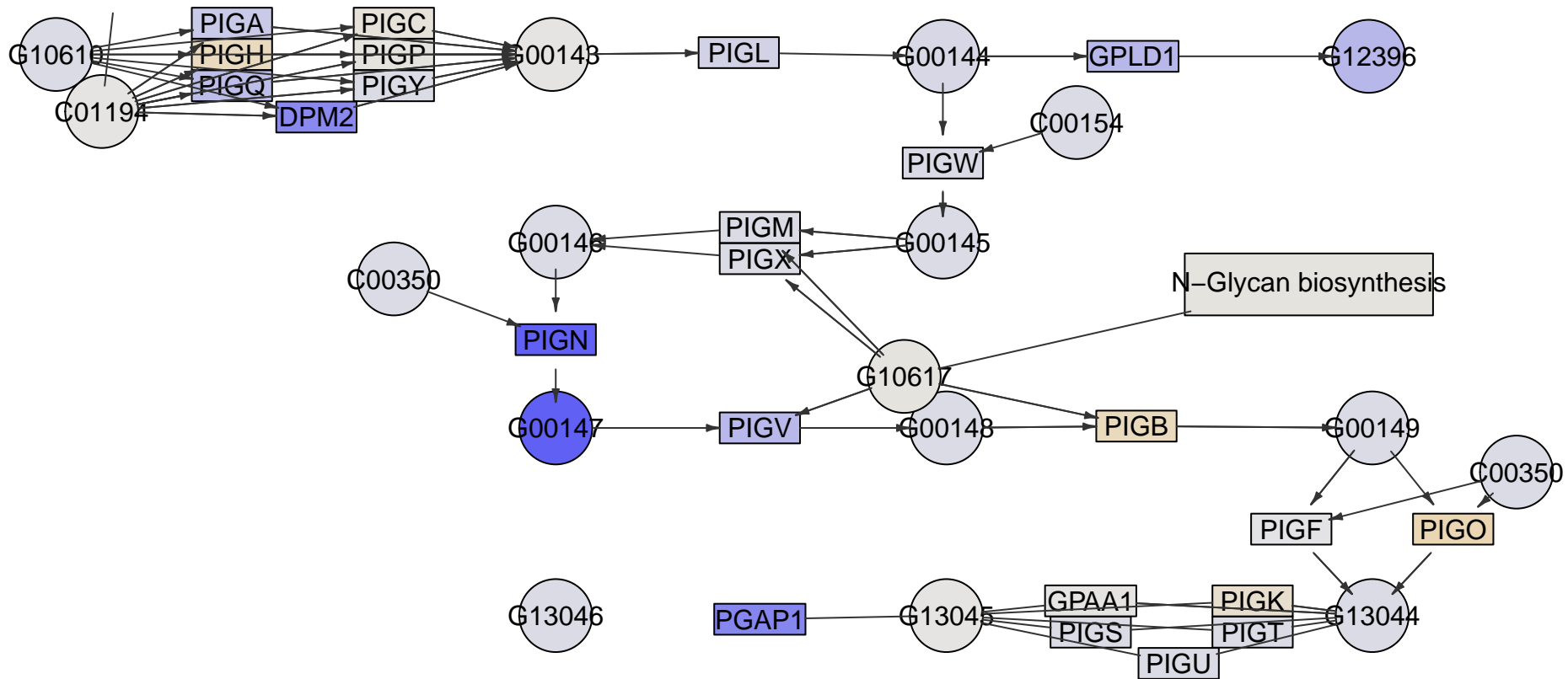

N-Glycan biosynthesis

PIGK

PIGO

PIGG

PIGN

PIGZ

PIGB

PIGV

PIGM

PIGA

Glycosylphosphatidylinositol(GPI)-anchor
biosynthesis
MPI-179

Glycerophospholipid
metabolism

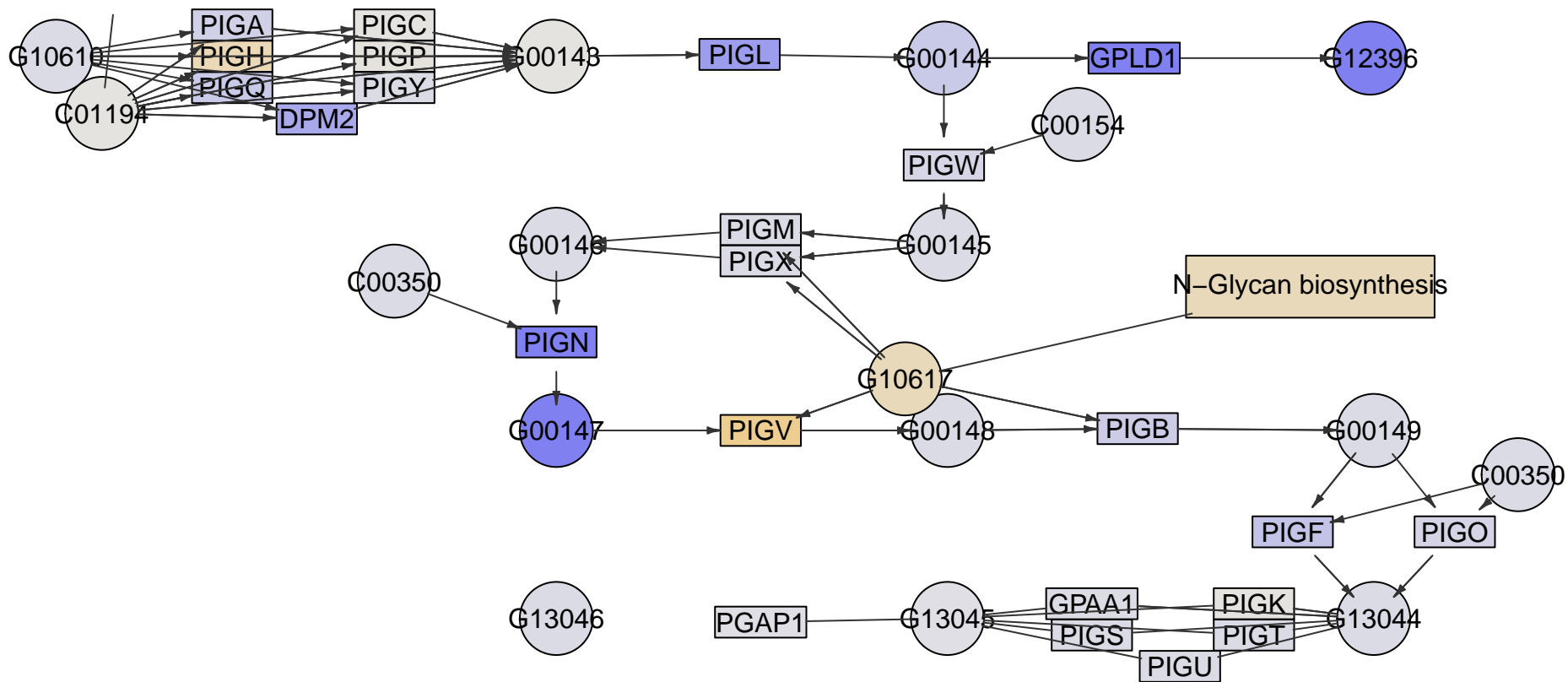

PIGK

PIGO

PIGG

PIGN

PIGZ

PIGB

PIGV

PIGM

PIGA

Glycosylphosphatidylinositol(GPI)-anchor
biosynthesis
MPI-180

Glycerophospholipid
metabolism

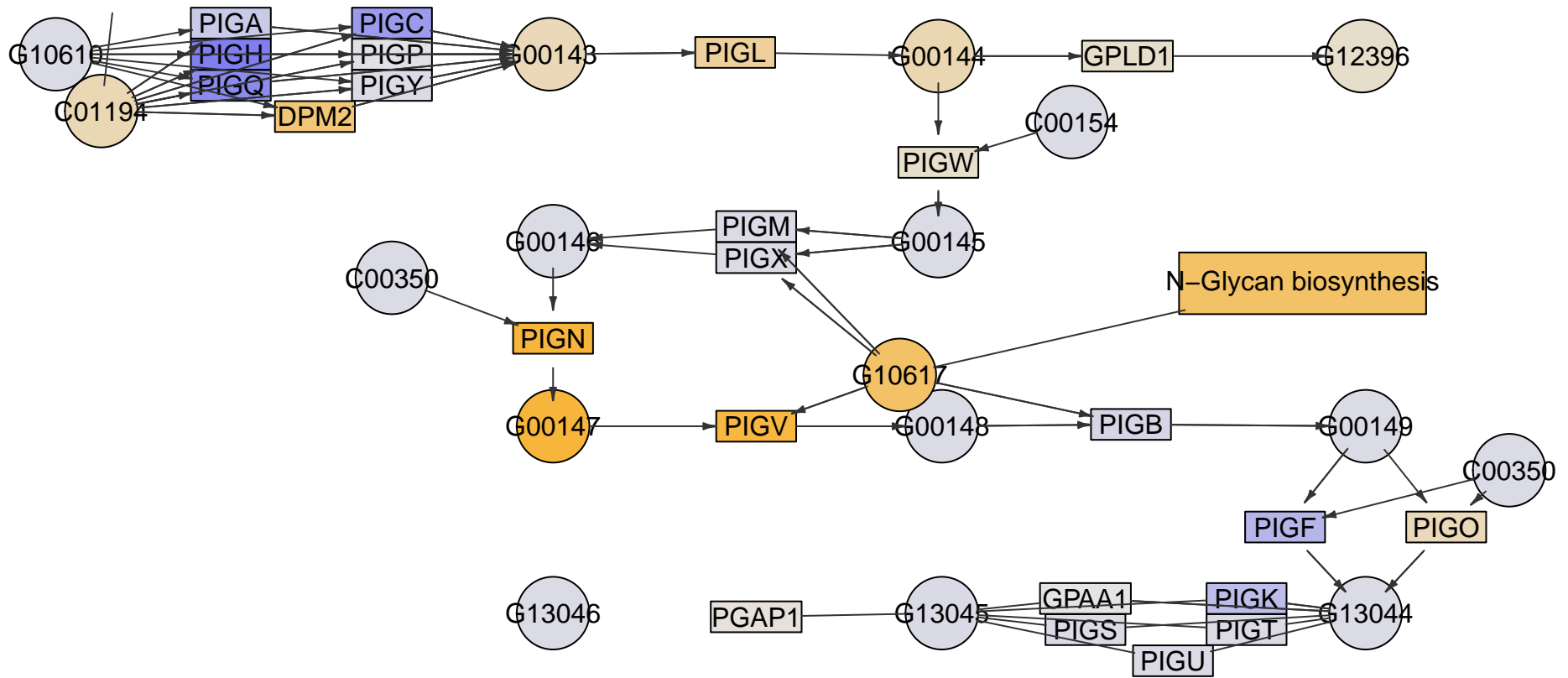

PIGK

PIGO

PIGG

PIGN

PIGZ

PIGB

PIGV

PIGM

PIGA

Glycosylphosphatidylinositol(GPI)-anchor
biosynthesis
MPI-182

Glycerophospholipid
metabolism

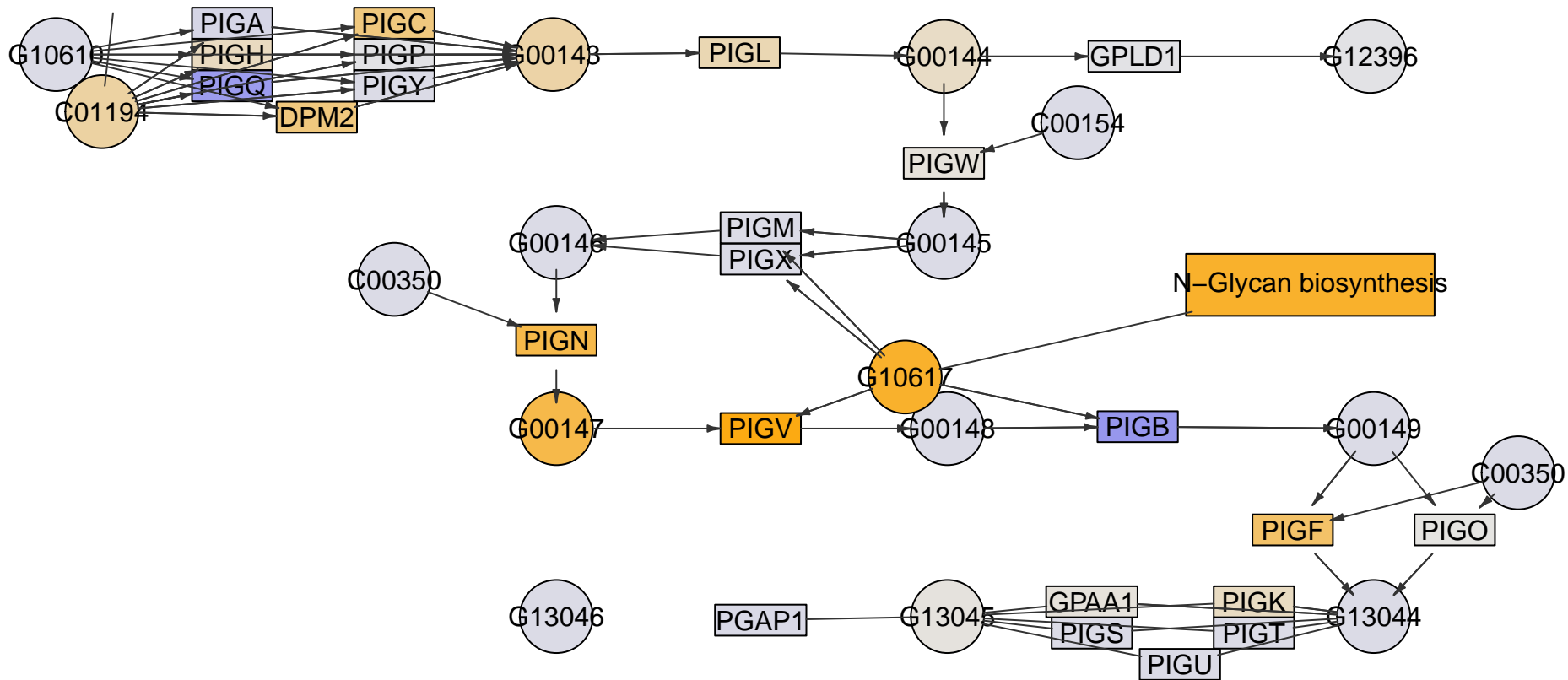

PIGK

PIGO

PIGG

PIGN

PIGZ

PIGB

PIGV

PIGM

PIGA

Glycosylphosphatidylinositol(GPI)-anchor
biosynthesis
MPI-183

Glycerophospholipid
metabolism

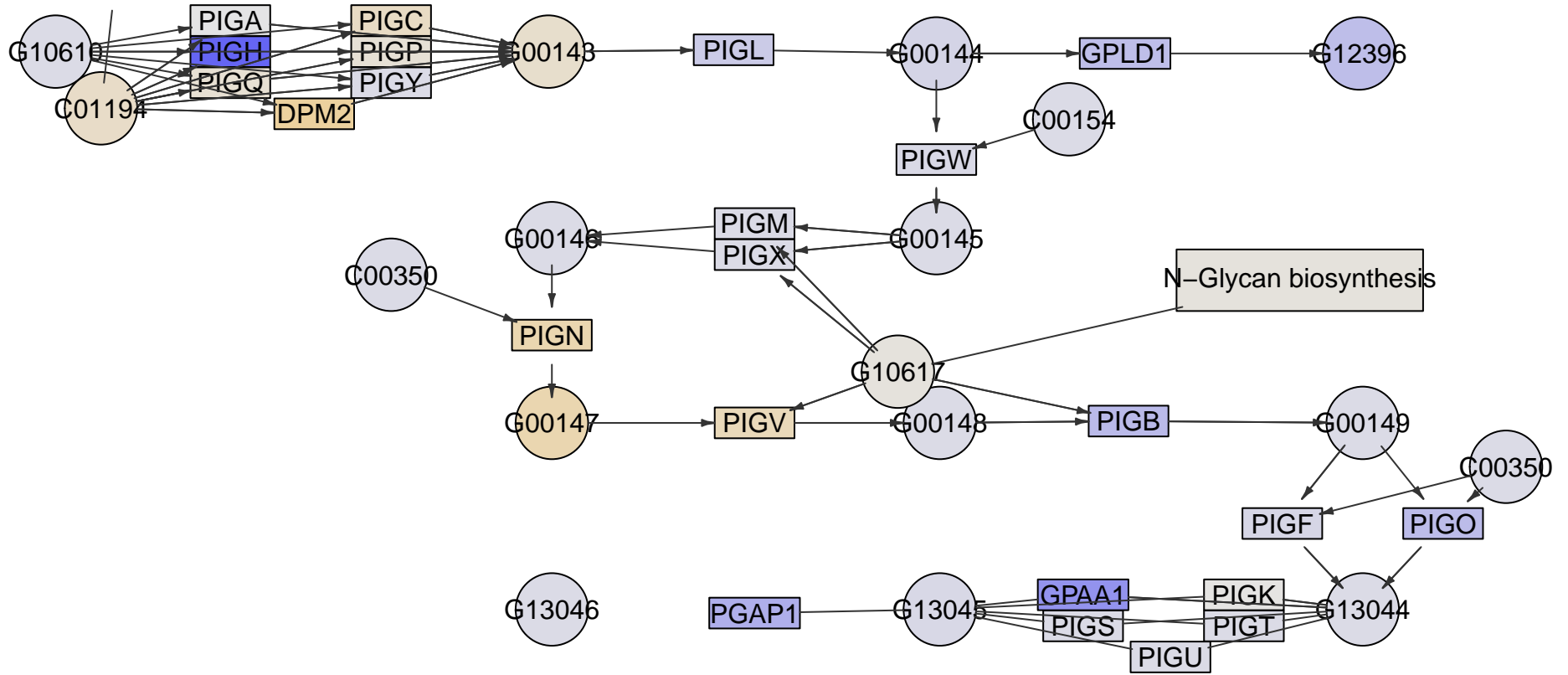

PIGK

PIGO

PIGG

PIGN

PIGZ

PIGB

PIGV

PIGM

PIGA

Glycosylphosphatidylinositol(GPI)-anchor
biosynthesis
MPI-184

Glycerophospholipid
metabolism

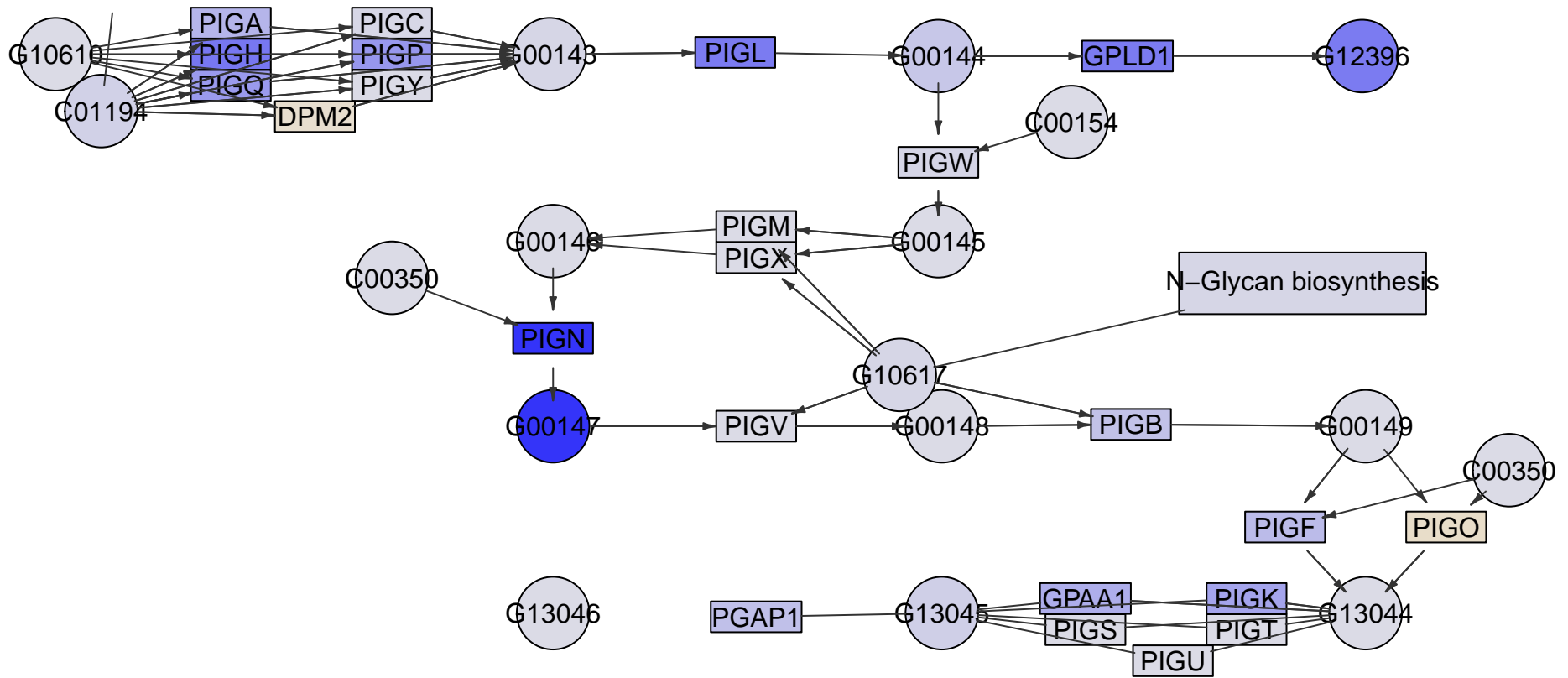

PIGK

PIGO

PIGG

PIGN

PIGZ

PIGB

PIGV

PIGM

PIGA

Glycosylphosphatidylinositol(GPI)-anchor
biosynthesis
MPI-185

Glycerophospholipid
metabolism

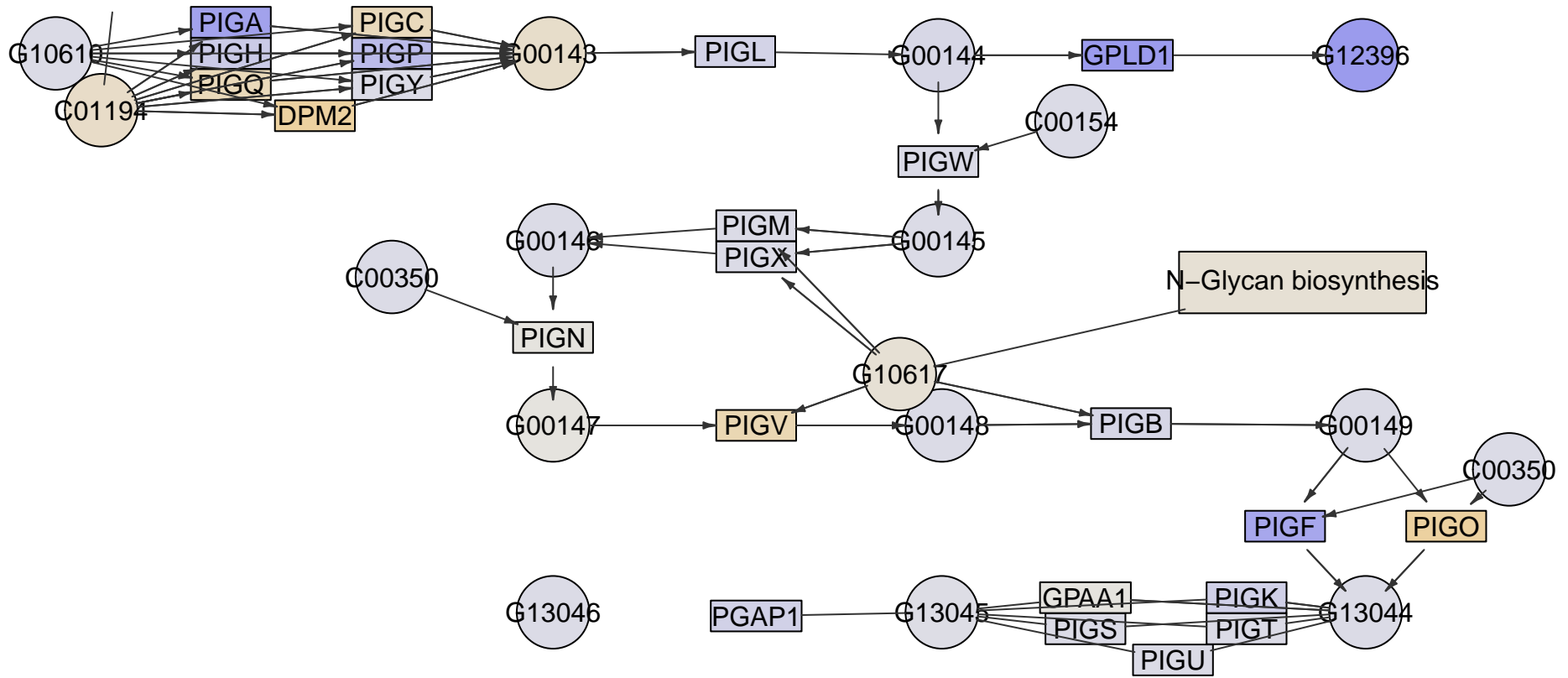

PIGK

PIGO

PIGG

PIGN

PIGZ

PIGB

PIGV

PIGM

PIGA

Glycosylphosphatidylinositol(GPI)-anchor
biosynthesis
MPI-186

Glycerophospholipid
metabolism

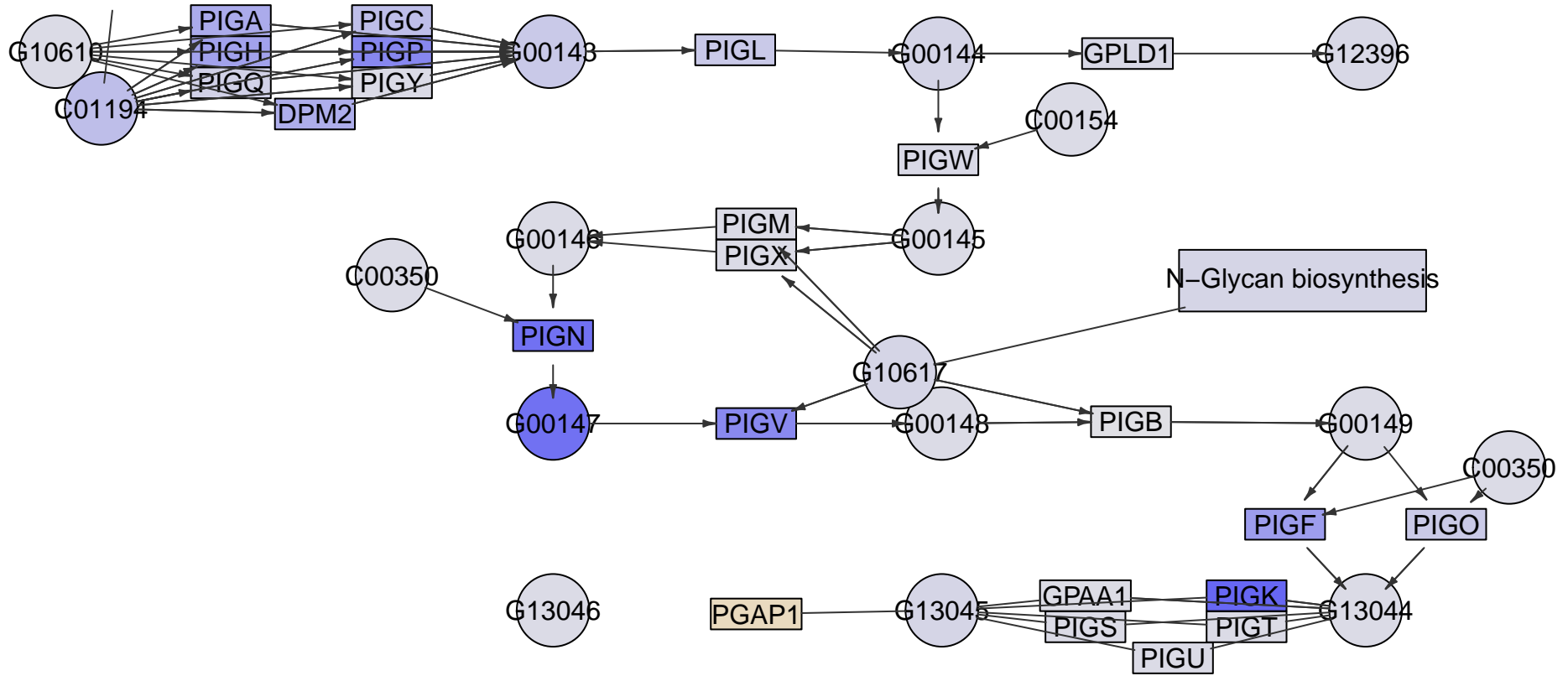

PIGK

PIGO

PIGG

PIGN

PIGZ

PIGB

PIGV

PIGM

PIGA

N-Glycan biosynthesis

Glycosylphosphatidylinositol(GPI)-anchor
biosynthesis
MPI-188

Glycerophospholipid
metabolism

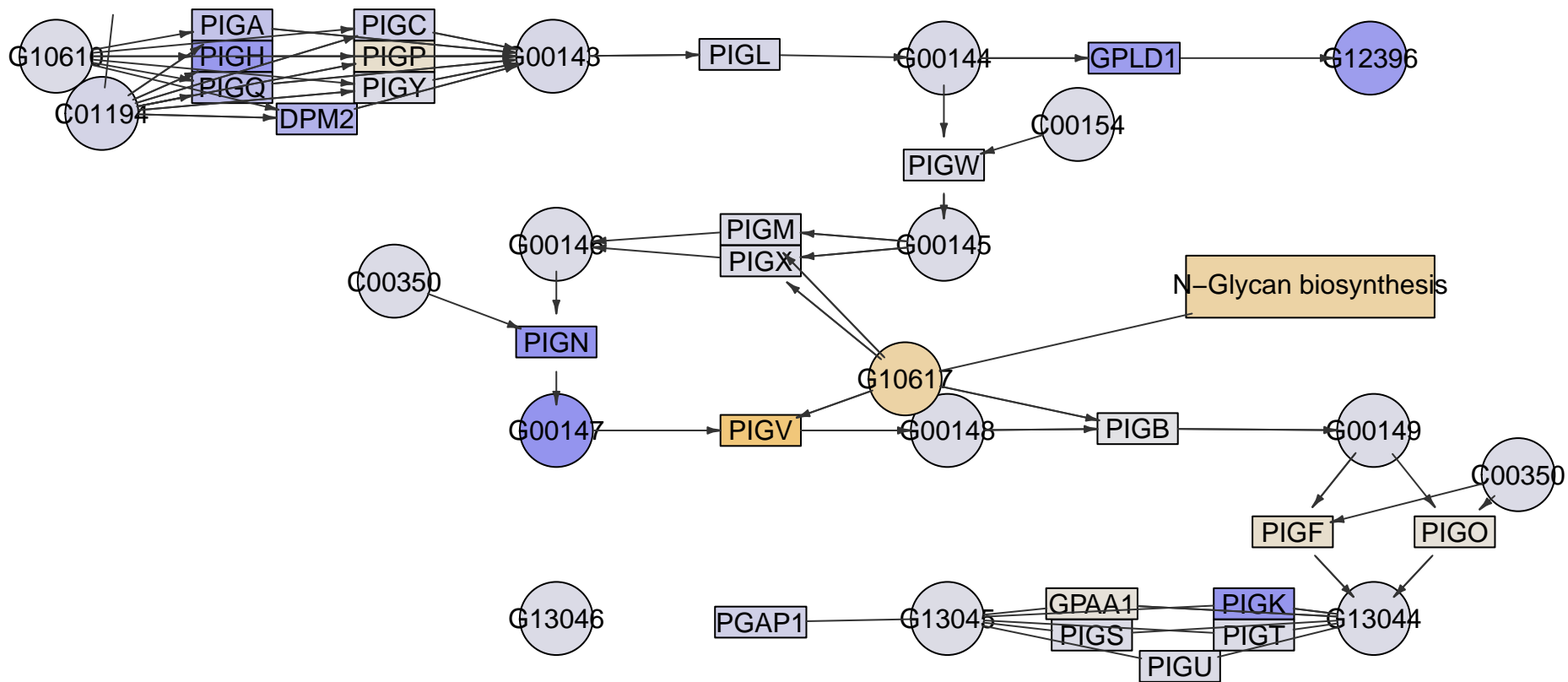

PIGK

PIGO

PIGG

PIGN

PIGZ

PIGB

PIGV

PIGM

PIGA

Glycosylphosphatidylinositol(GPI)-anchor
biosynthesis
MPI-189

Glycerophospholipid
metabolism

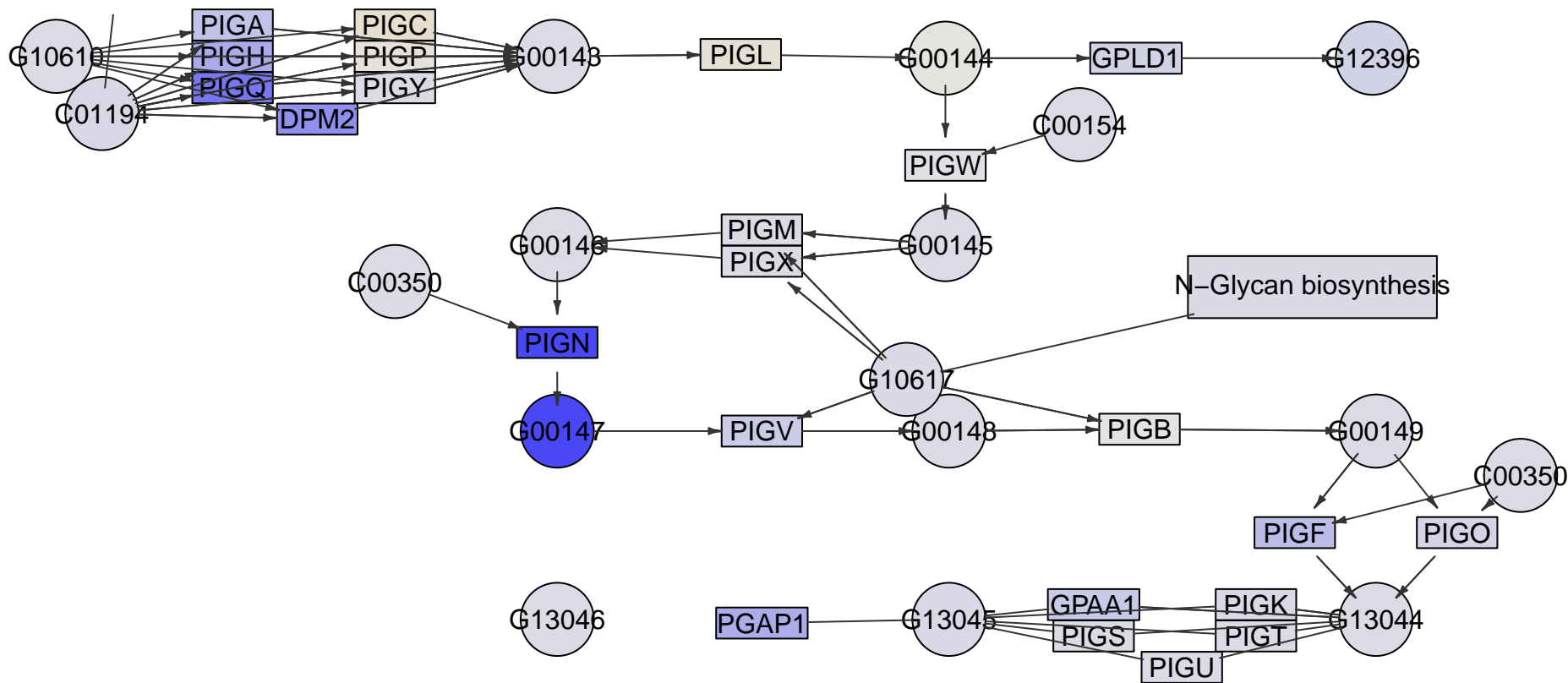

PIGK

PIGO

PIGG

PIGN

PIGZ

PIGB

PIGV

PIGM

PIGA

Glycosylphosphatidylinositol(GPI)-anchor
biosynthesis
MPI-190

Glycerophospholipid
metabolism

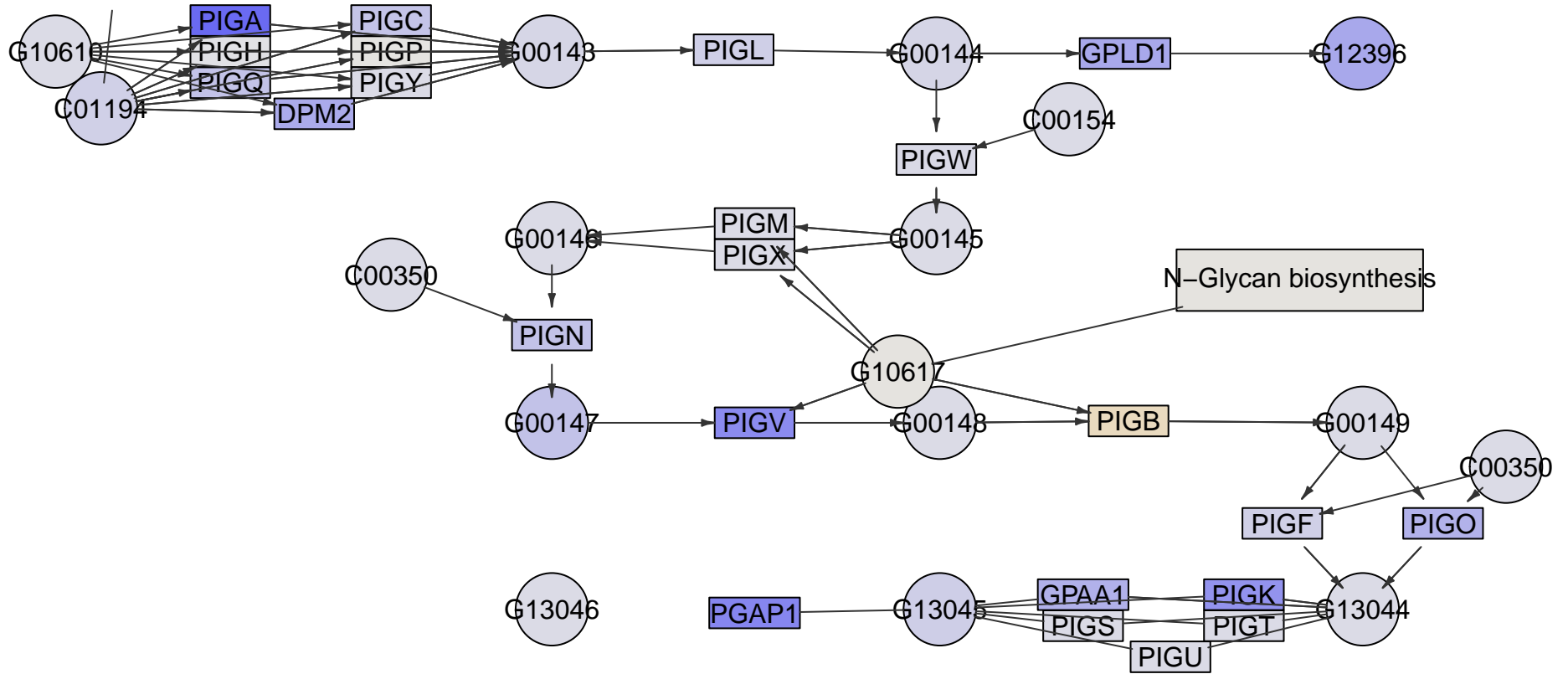

PIGK

PIGO

PIGG

PIGN

PIGZ

PIGB

PIGV

PIGM

PIGA

Glycosylphosphatidylinositol(GPI)-anchor
biosynthesis
MPI-191

Glycerophospholipid
metabolism

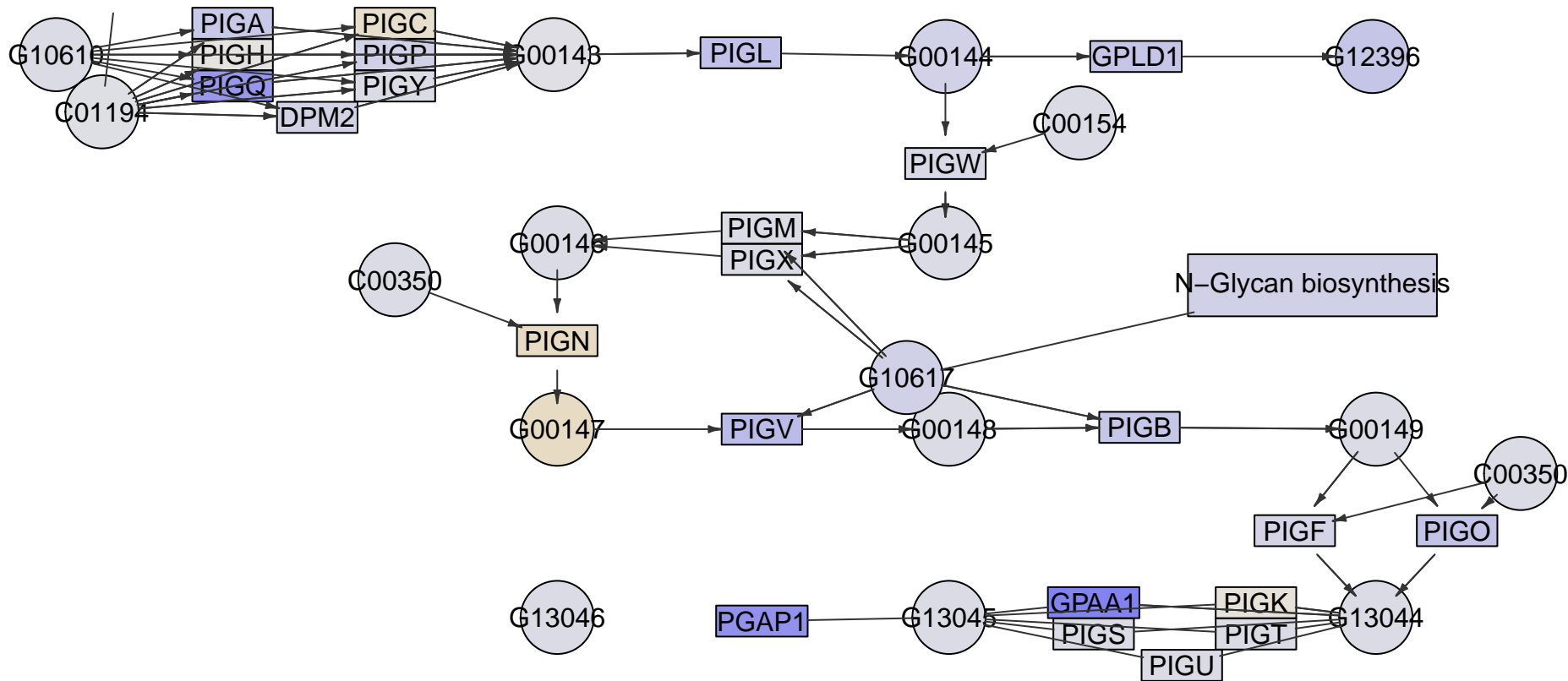

PIGK

PIGO

PIGG

PIGN

PIGZ

PIGB

PIGV

PIGM

PIGA

Glycosylphosphatidylinositol(GPI)-anchor
biosynthesis
MPI-192

Glycerophospholipid
metabolism

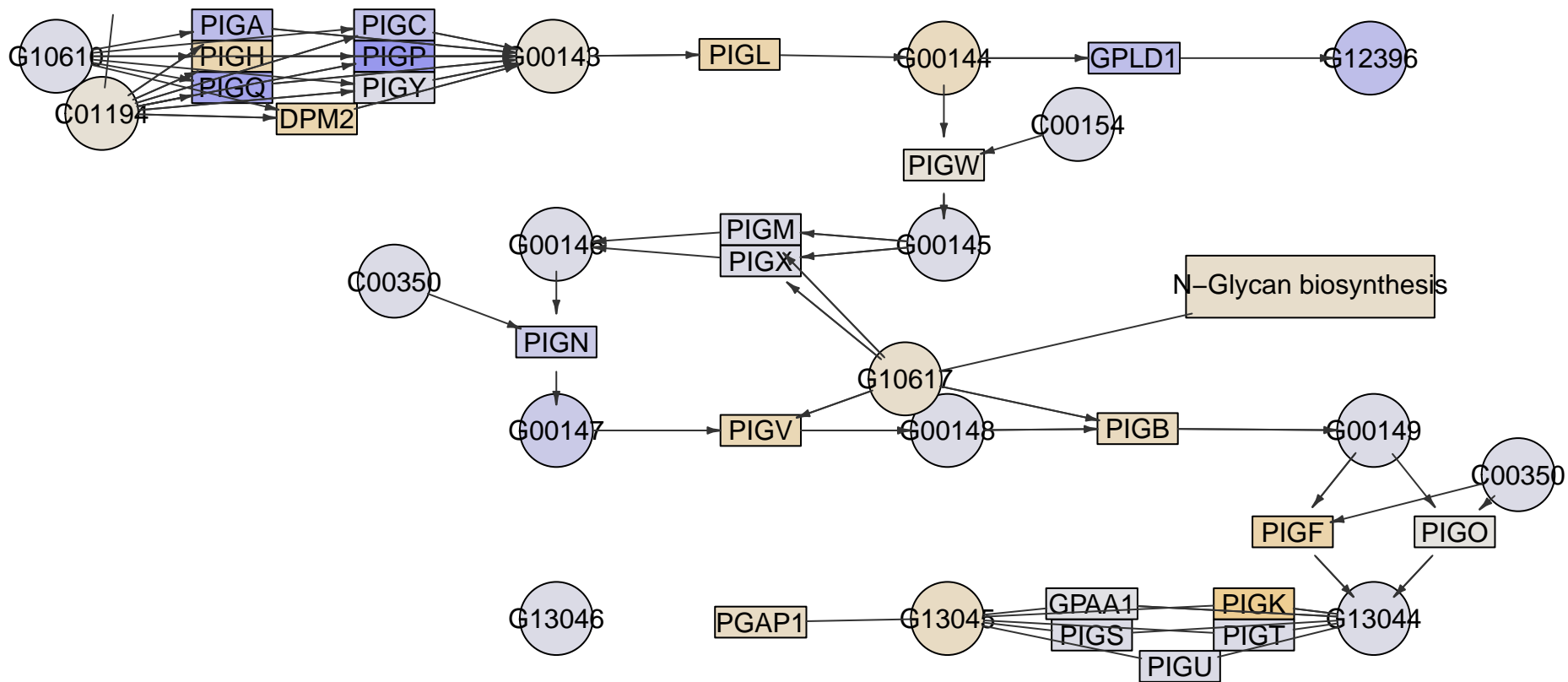

PIGK

PIGO

PIGG

PIGN

PIGZ

PIGB

PIGV

PIGM

PIGA

Glycosylphosphatidylinositol(GPI)-anchor
biosynthesis
MPI-194

Glycerophospholipid
metabolism

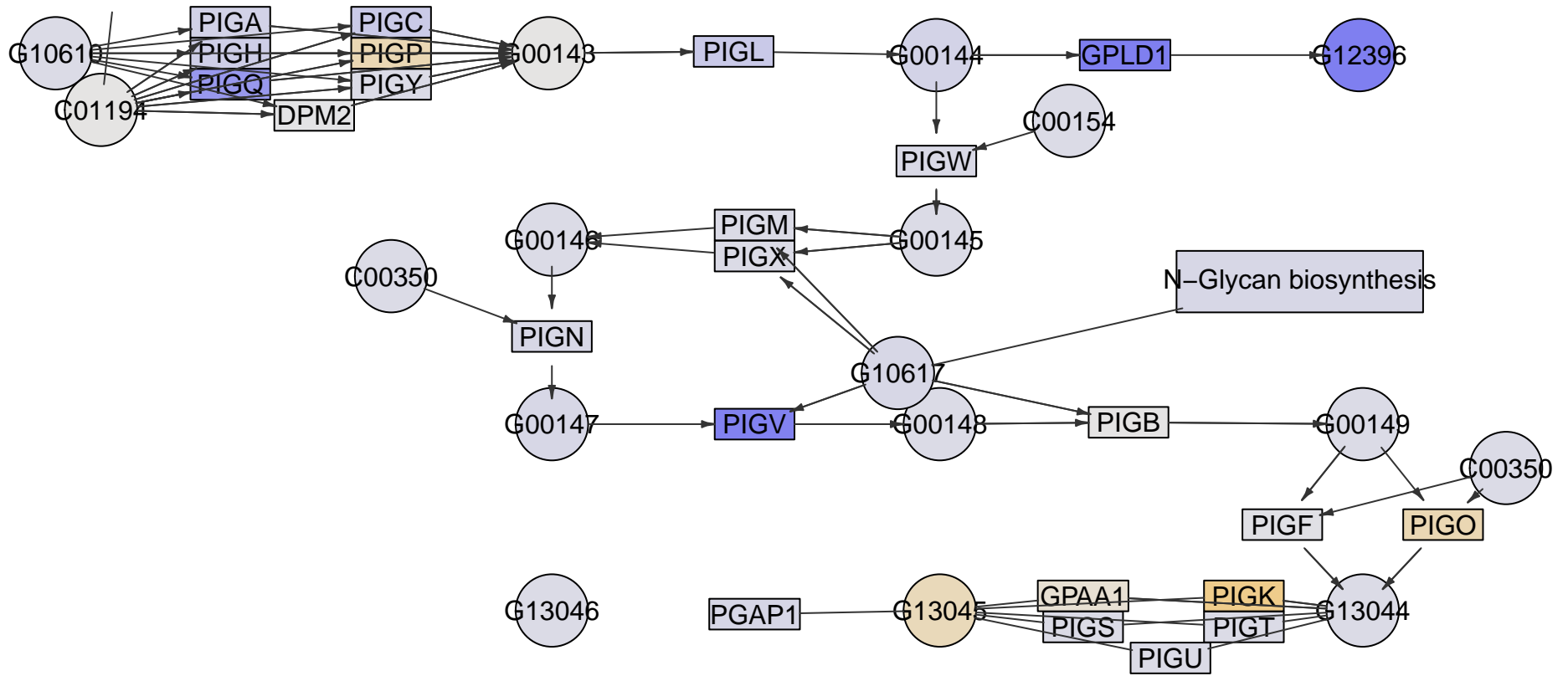

PIGK

PIGO

PIGG

PIGN

PIGZ

PIGB

PIGV

PIGM

PIGA

Glycosylphosphatidylinositol(GPI)-anchor
biosynthesis
MPI-195

Glycerophospholipid
metabolism

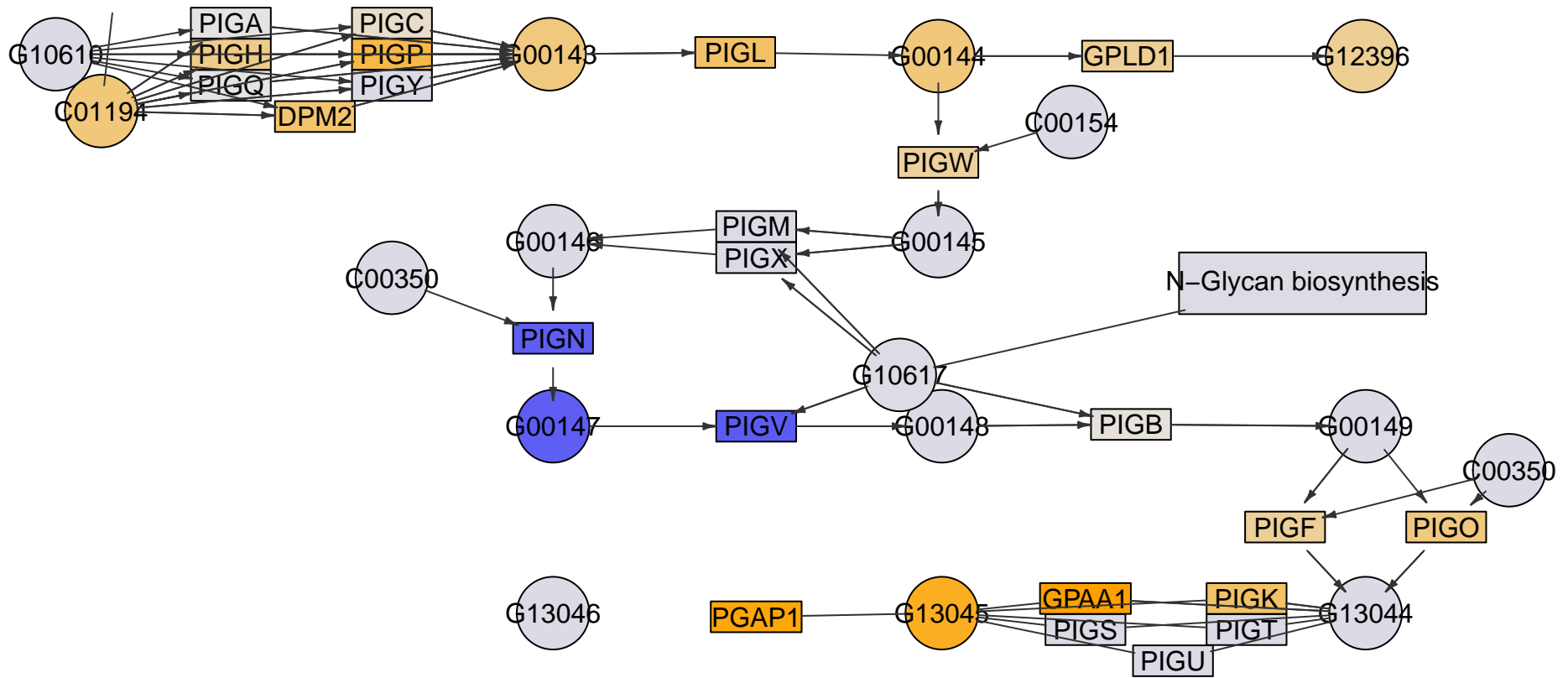

PIGK

PIGO

PIGG

PIGN

PIGZ

PIGB

PIGV

PIGM

PIGA

Glycosylphosphatidylinositol(GPI)-anchor
biosynthesis
MPI-196

Glycerophospholipid
metabolism

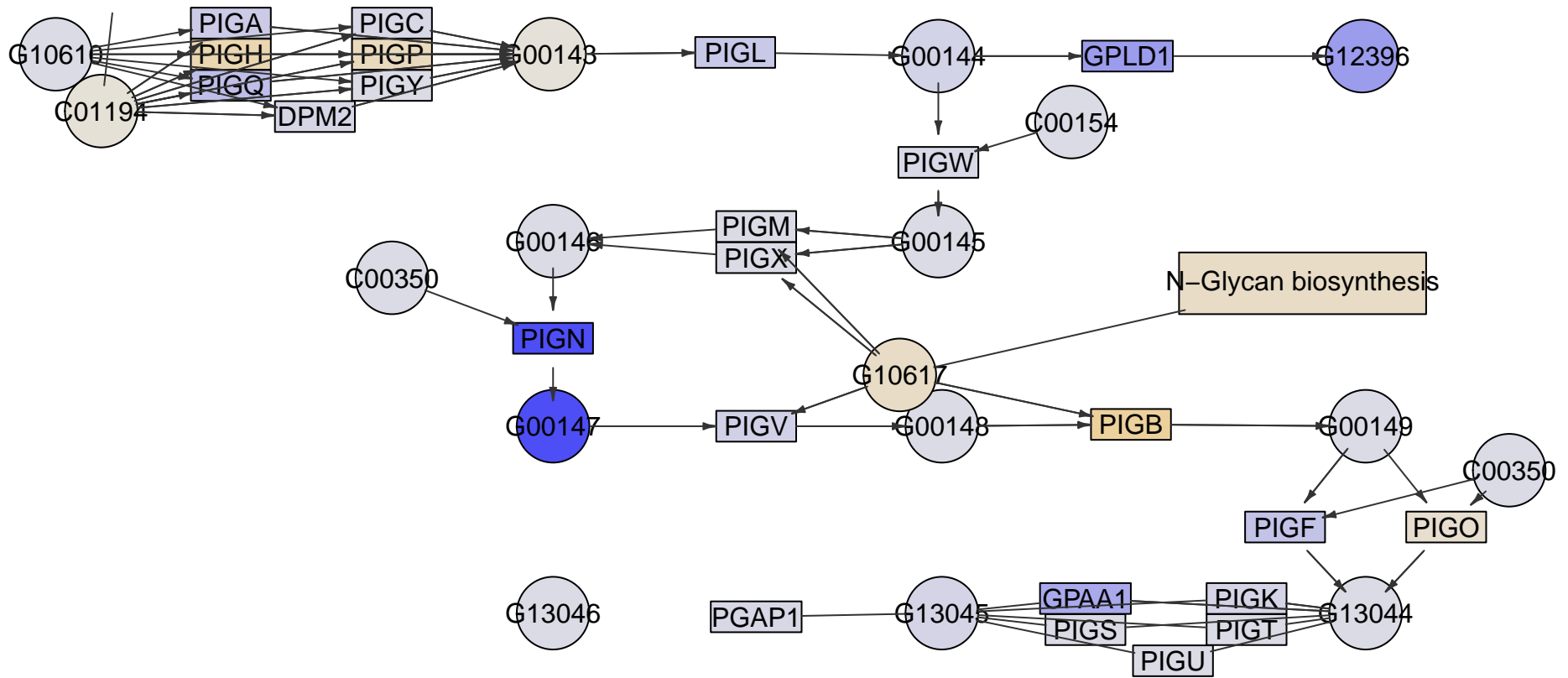

PIGK

PIGO

PIGG

PIGN

PIGZ

PIGB

PIGV

PIGM

PIGA

Glycosylphosphatidylinositol(GPI)-anchor
biosynthesis
MPI-198

Glycerophospholipid
metabolism

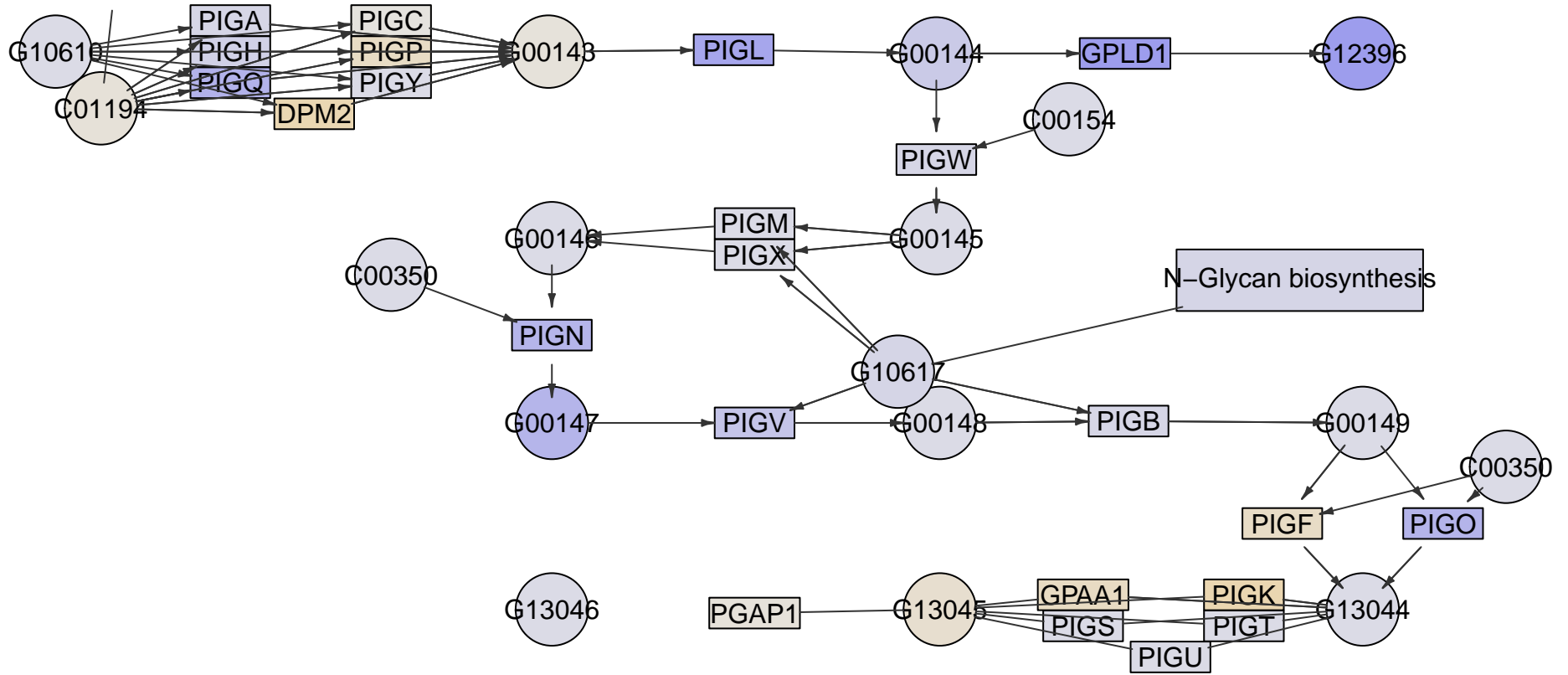

PIGK

PIGO

PIGG

PIGN

PIGZ

PIGB

PIGV

PIGM

PIGA

Glycosylphosphatidylinositol(GPI)-anchor
biosynthesis
MPI-199

Glycerophospholipid
metabolism

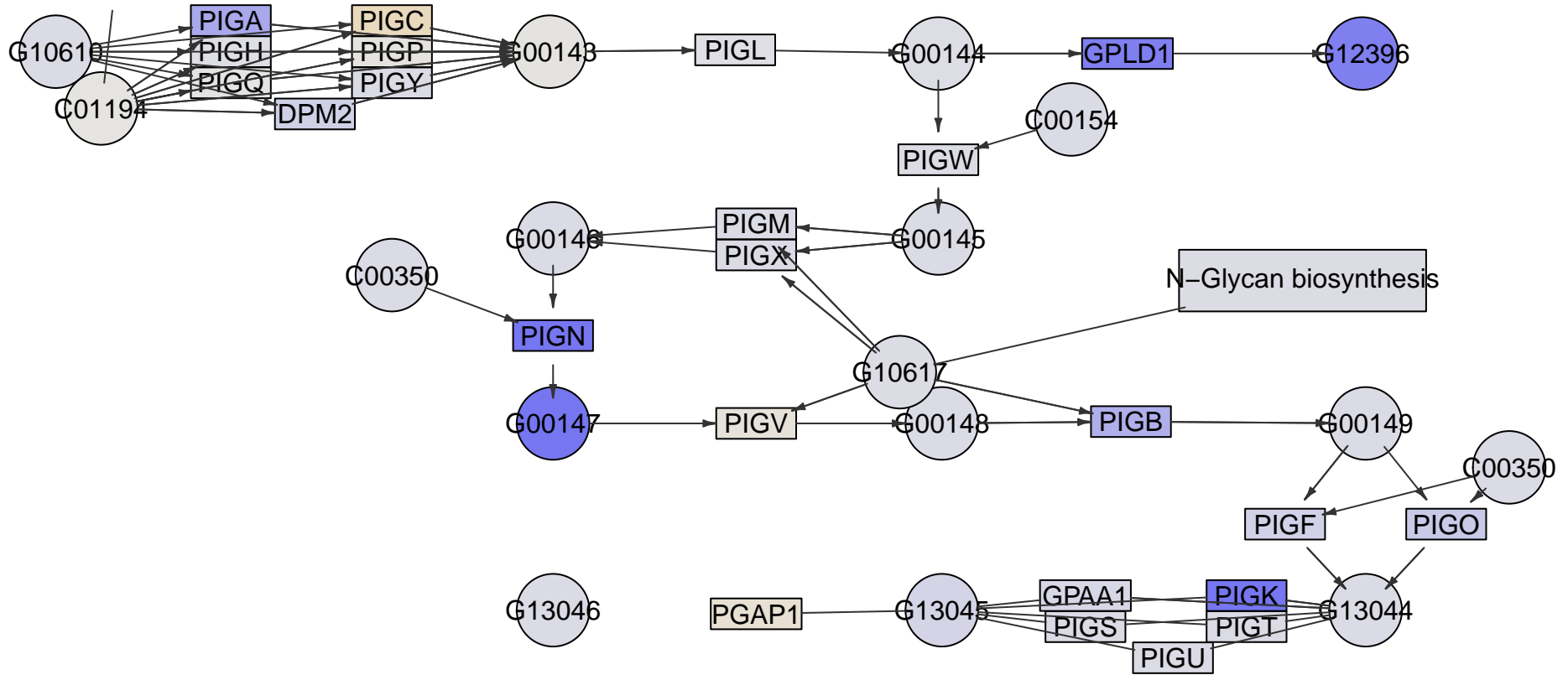

PIGK

PIGO

PIGG

PIGN

PIGZ

PIGB

PIGV

PIGM

PIGA

Glycosylphosphatidylinositol(GPI)-anchor
biosynthesis
MPI-200

Glycerophospholipid
metabolism

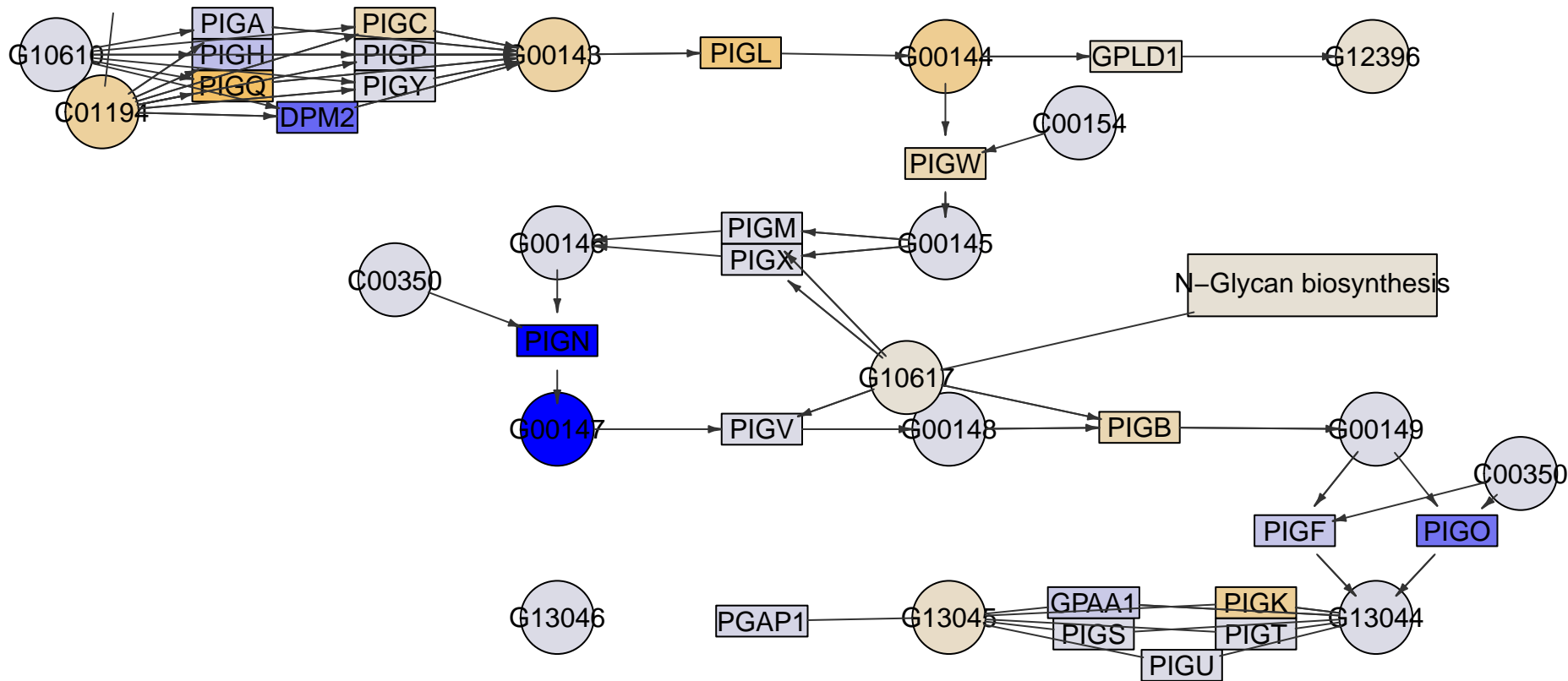

PIGK

PIGO

PIGG

PIGN

PIGZ

PIGB

PIGV

PIGM

PIGA

Glycosylphosphatidylinositol(GPI)-anchor
biosynthesis
MPI-201

Glycerophospholipid
metabolism

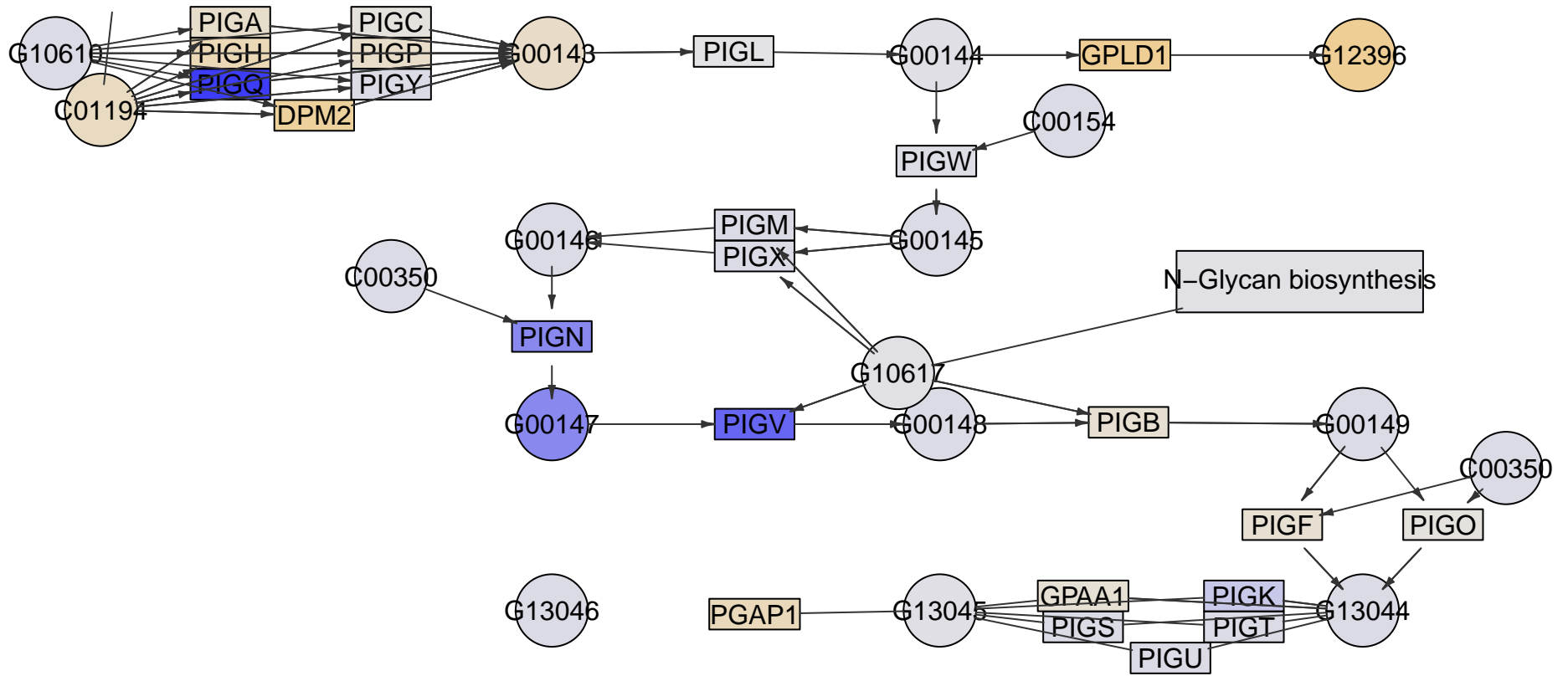

PIGK

PIGO

PIGG

PIGN

PIGZ

PIGB

PIGV

PIGM

PIGA

Glycosylphosphatidylinositol(GPI)-anchor
biosynthesis
MPI-202

Glycerophospholipid
metabolism

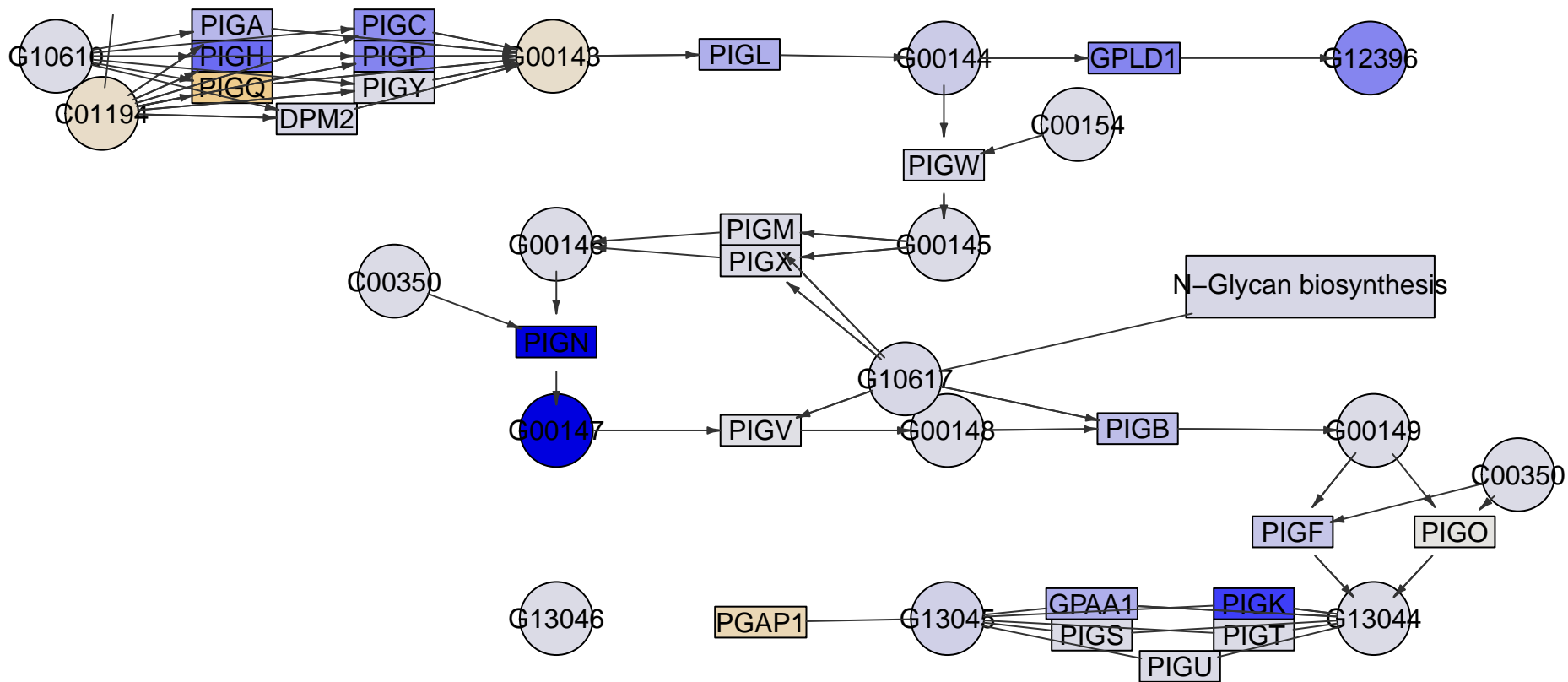

N-Glycan biosynthesis

PIGK

PIGO

PIGG

PIGN

PIGZ

PIGB

PIGV

PIGM

PIGA

Glycosylphosphatidylinositol(GPI)-anchor
biosynthesis
MPI-203

Glycerophospholipid
metabolism

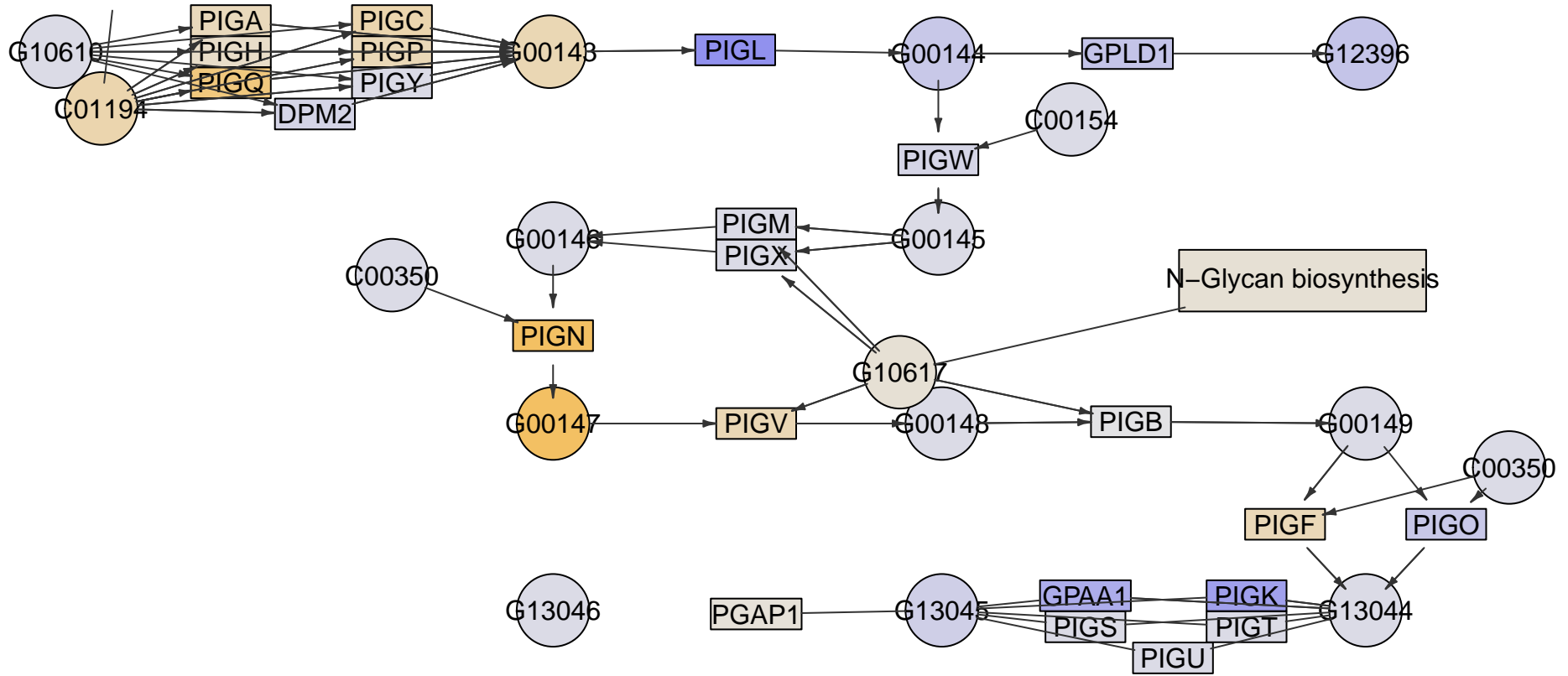

PIGK

PIGO

PIGG

PIGN

PIGZ

PIGB

PIGV

PIGM

PIGA

Glycosylphosphatidylinositol(GPI)-anchor
biosynthesis
MPI-204

Glycerophospholipid
metabolism

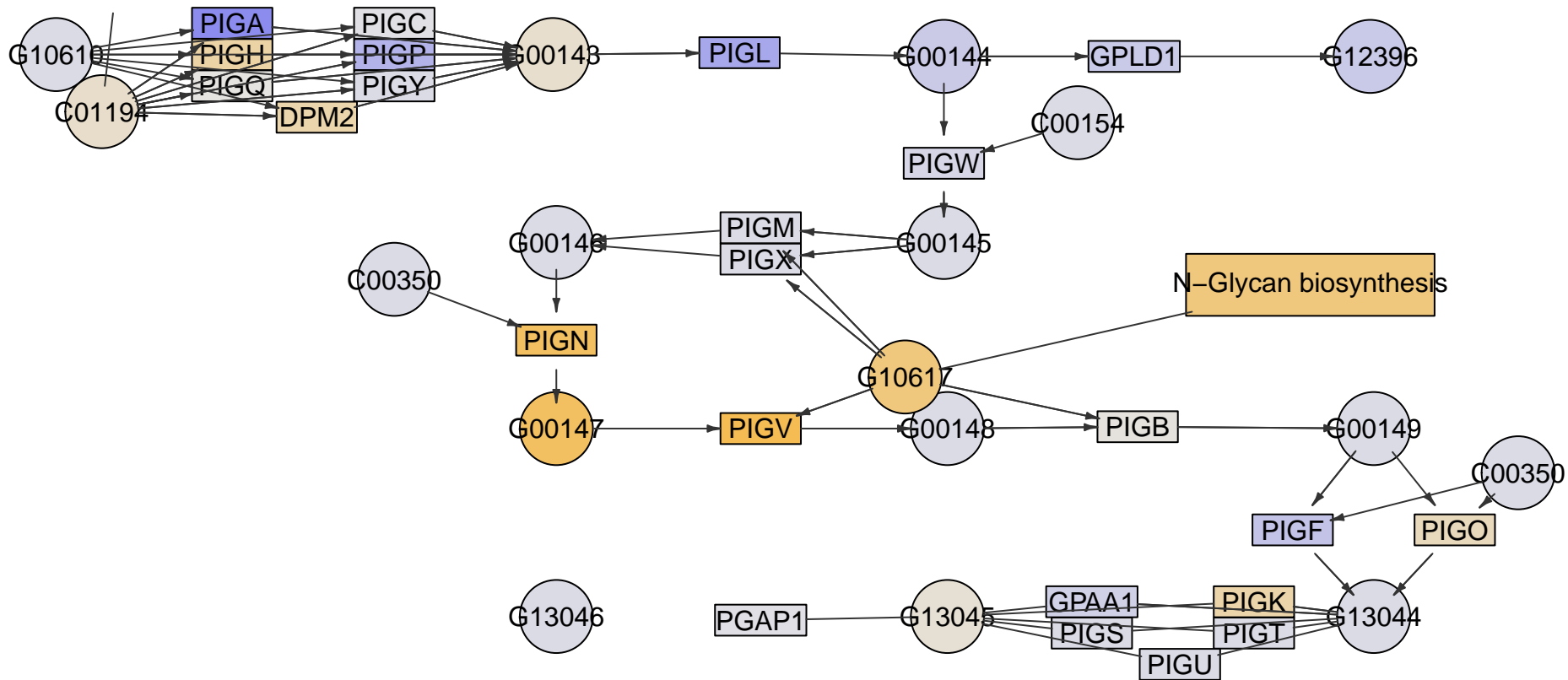

PIGK

PIGO

PIGG

PIGN

PIGZ

PIGB

PIGV

PIGM

PIGA

Glycosylphosphatidylinositol(GPI)-anchor
biosynthesis
MPI-205

Glycerophospholipid
metabolism

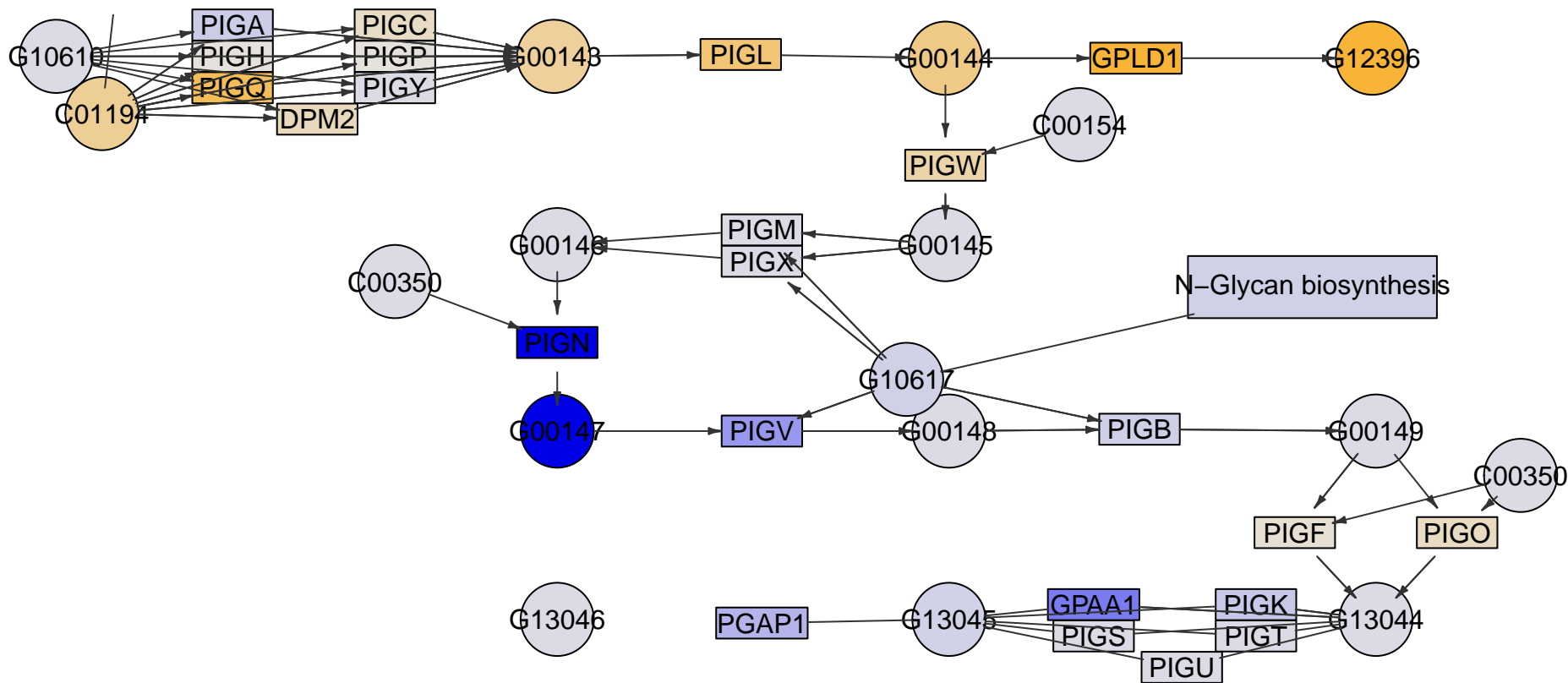

N-Glycan biosynthesis

PIGK

PIGO

PIGG

PIGN

PIGZ

PIGB

PIGV

PIGM

PIGA

Glycosylphosphatidylinositol(GPI)-anchor
biosynthesis
MPI-206

Glycerophospholipid
metabolism

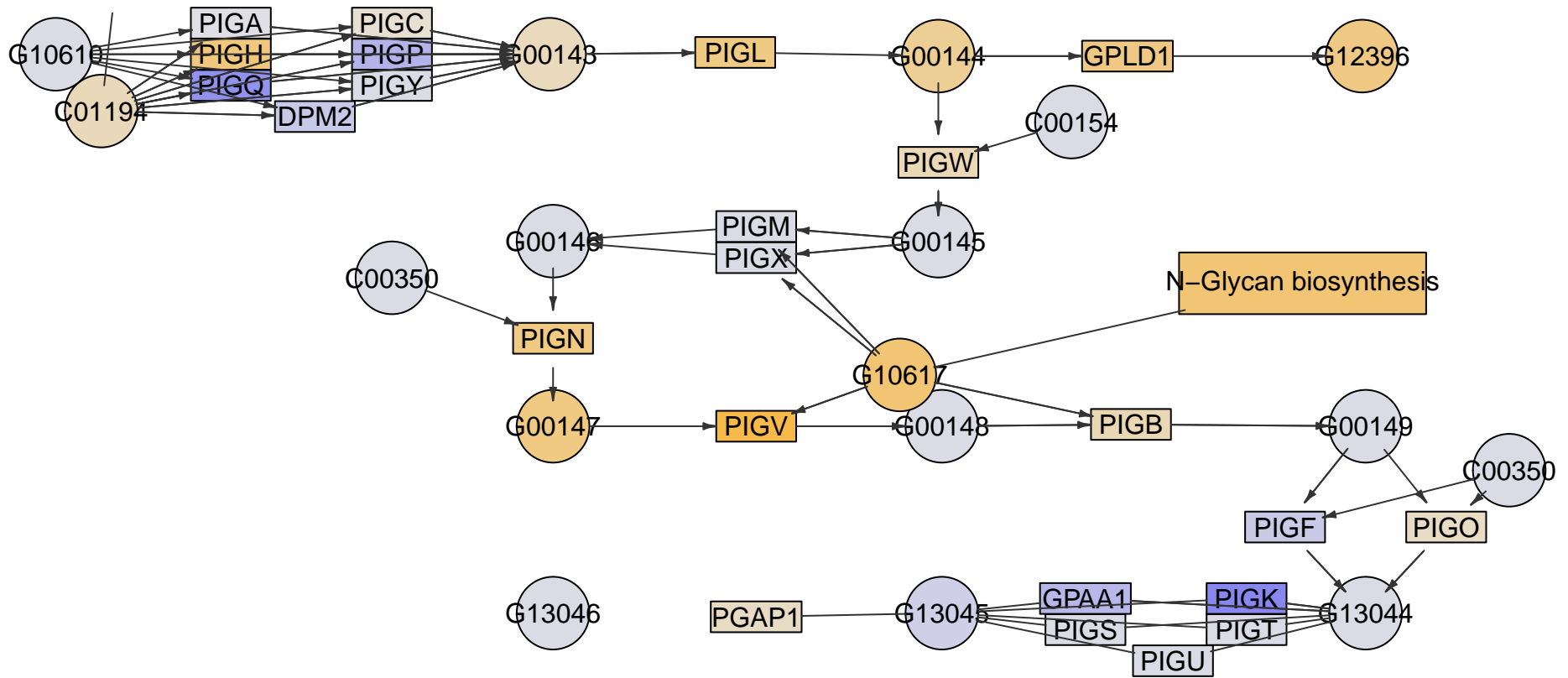

N-Glycan biosynthesis

PIGK

PIGO

PIGG

PIGN

PIGZ

PIGB

PIGV

PIGM

PIGA

Glycosylphosphatidylinositol(GPI)-anchor
biosynthesis
MPI-207

Glycerophospholipid
metabolism

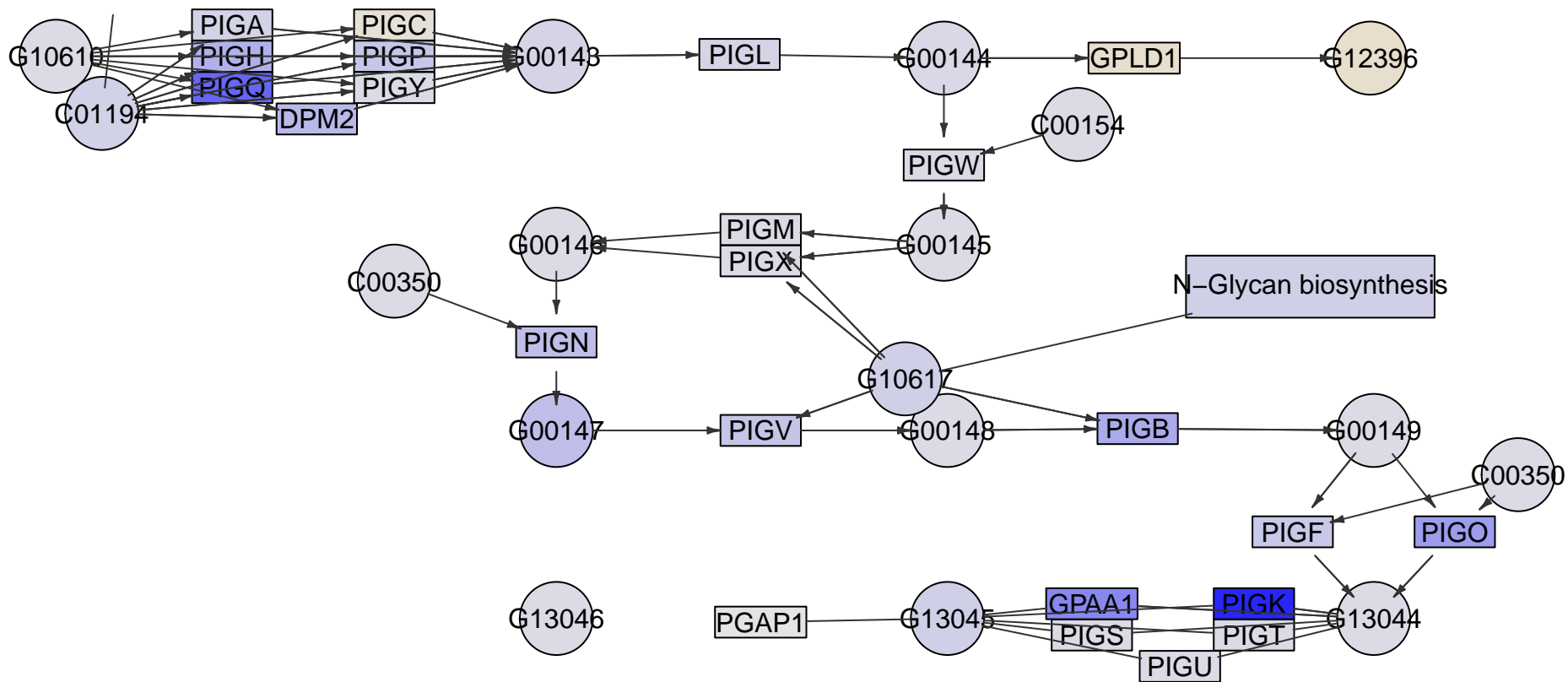

PIGK

PIGO

PIGG

PIGN

PIGZ

PIGB

PIGV

PIGM

PIGA

Glycosylphosphatidylinositol(GPI)-anchor
biosynthesis
MPI-208

Glycerophospholipid
metabolism

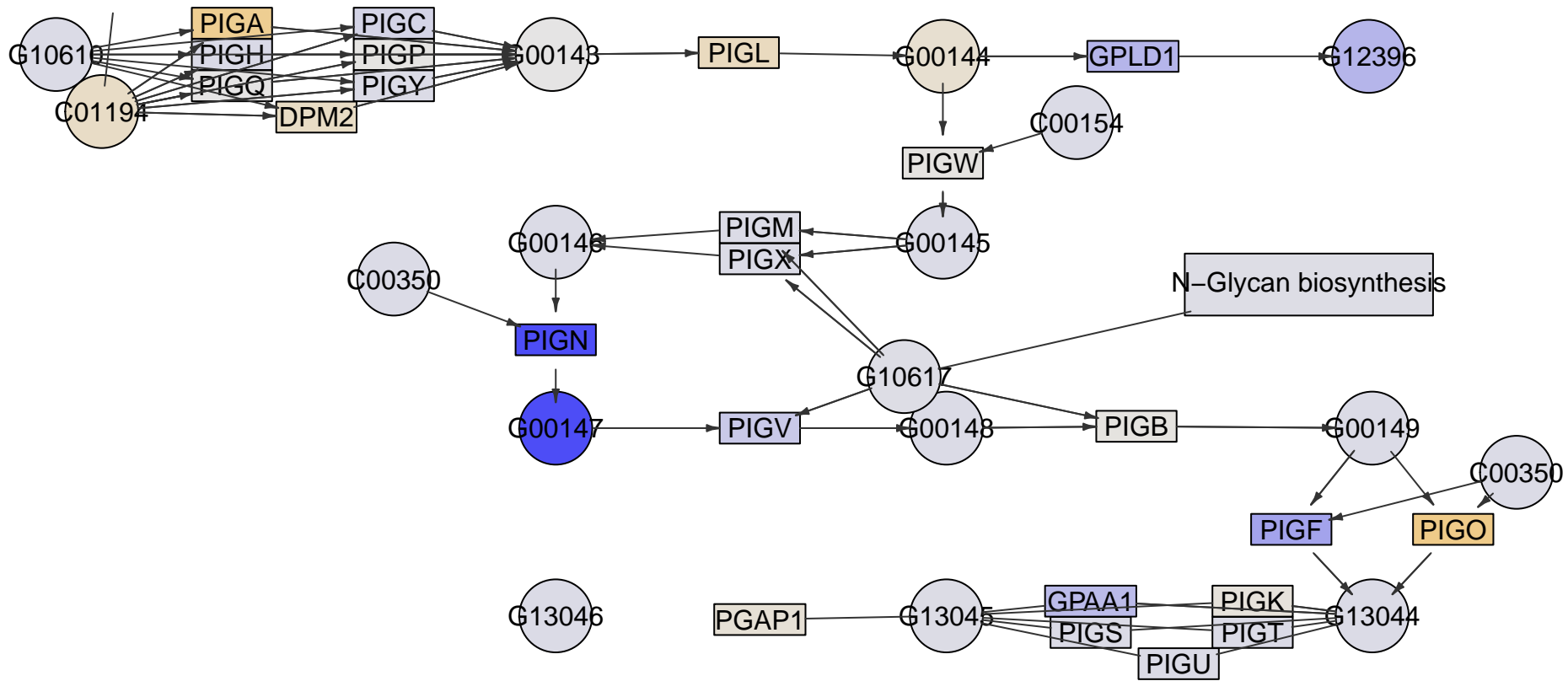

PIGK

PIGO

PIGG

PIGN

PIGZ

PIGB

PIGV

PIGM

PIGA

Glycosylphosphatidylinositol(GPI)-anchor
biosynthesis
MPI-209

Glycerophospholipid
metabolism

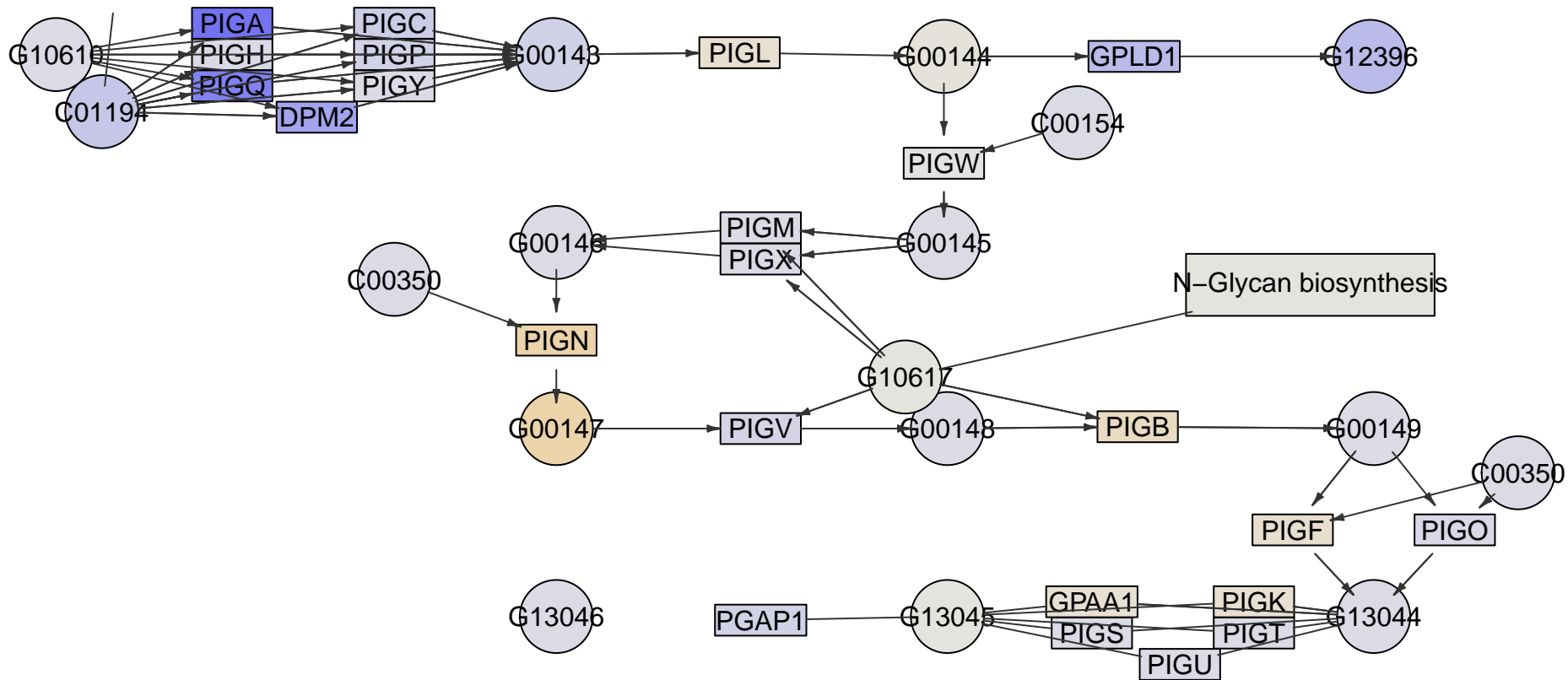

N-Glycan biosynthesis

PIGK

PIGO

PIGG

PIGN

PIGZ

PIGB

PIGV

PIGM

PIGA

Glycosylphosphatidylinositol(GPI)-anchor
biosynthesis
MPI-210

Glycerophospholipid
metabolism

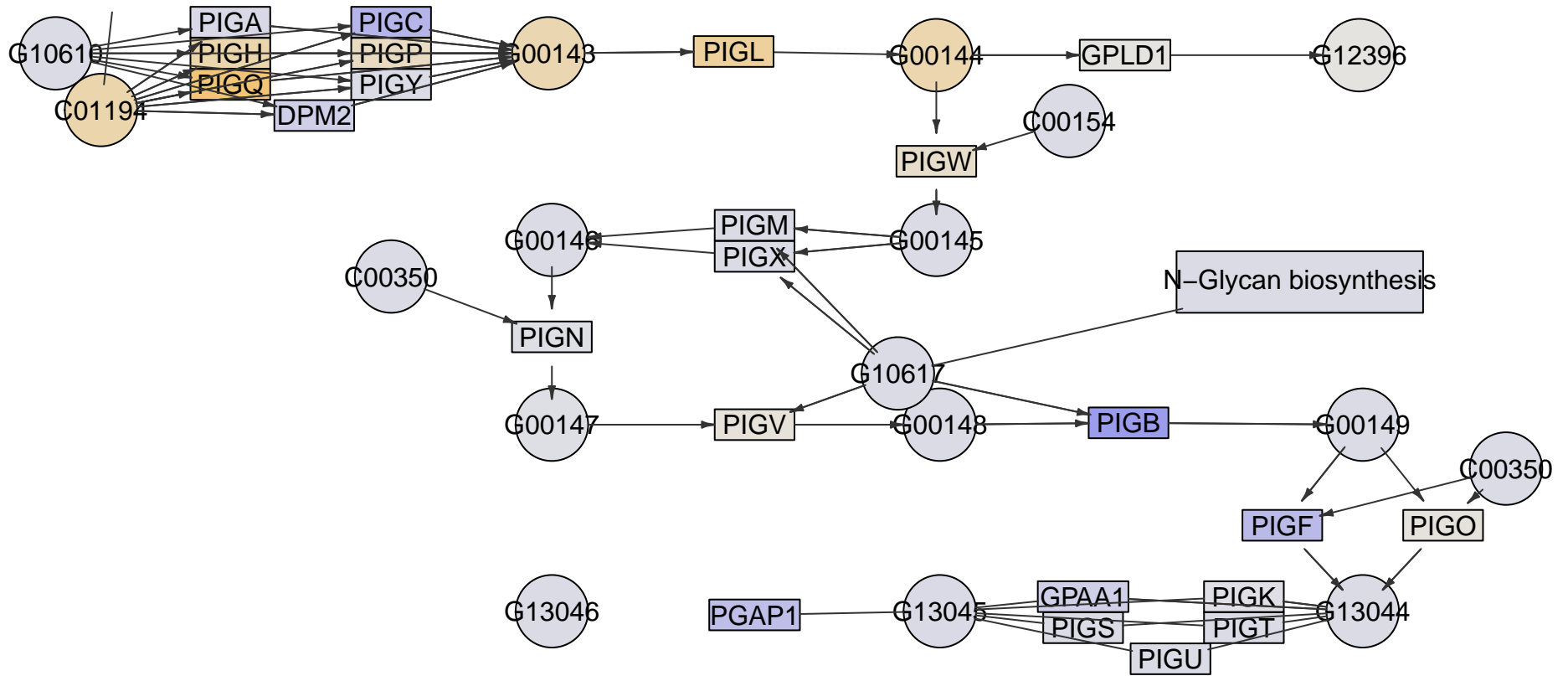

PIGK

PIGO

PIGG

PIGN

PIGZ

PIGB

PIGV

PIGM

PIGA

Glycosylphosphatidylinositol(GPI)-anchor
biosynthesis
MPI-212

Glycerophospholipid
metabolism

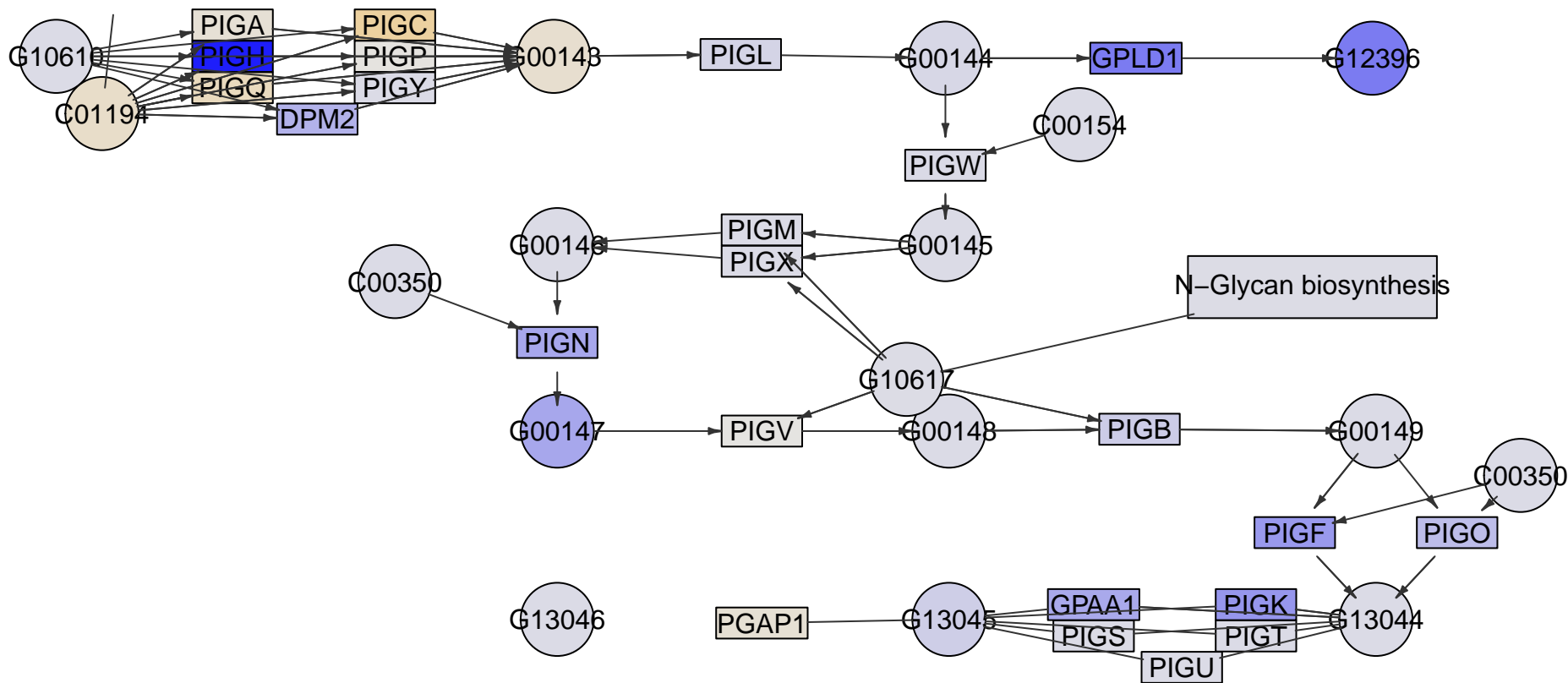

N-Glycan biosynthesis

PIGK

PIGO

PIGG

PIGN

PIGZ

PIGB

PIGV

PIGM

PIGA

Glycosylphosphatidylinositol(GPI)-anchor
biosynthesis
MPI-213

Glycerophospholipid
metabolism

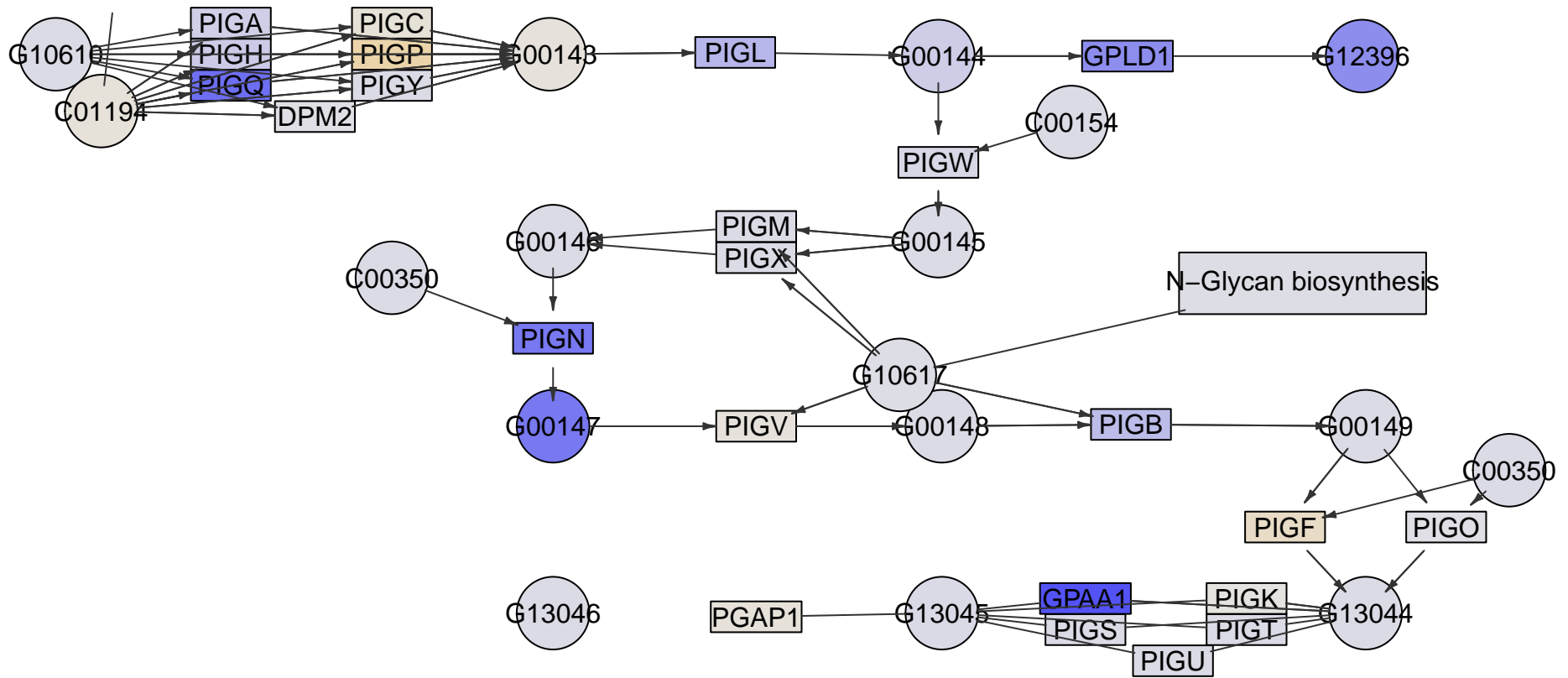

N-Glycan biosynthesis

PIGK

PIGO

PIGG

PIGN

PIGZ

PIGB

PIGV

PIGM

PIGA

Glycosylphosphatidylinositol(GPI)-anchor
biosynthesis
MPI-215

Glycerophospholipid
metabolism

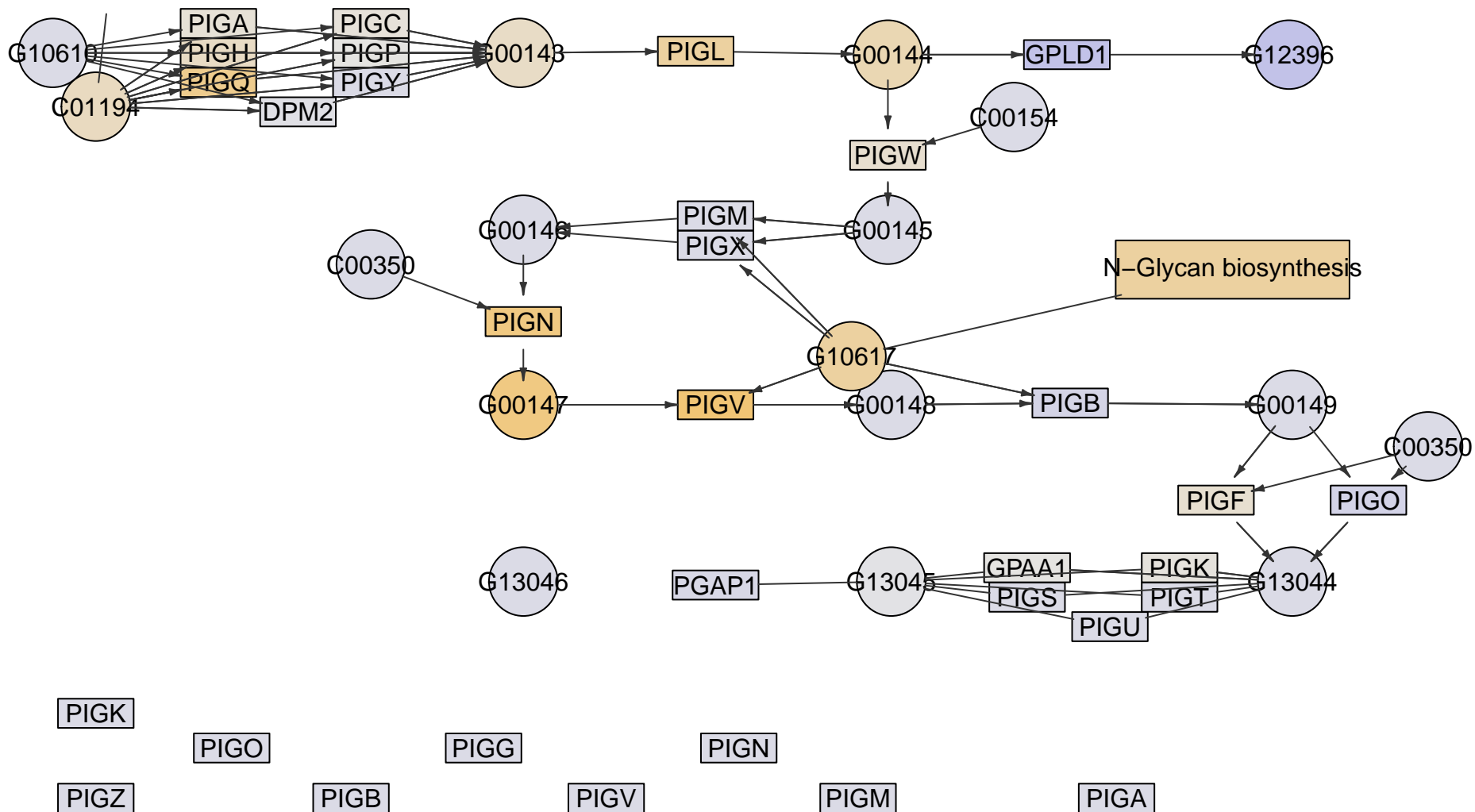

Glycosylphosphatidylinositol(GPI)-anchor
biosynthesis
MPI-219

Glycerophospholipid
metabolism

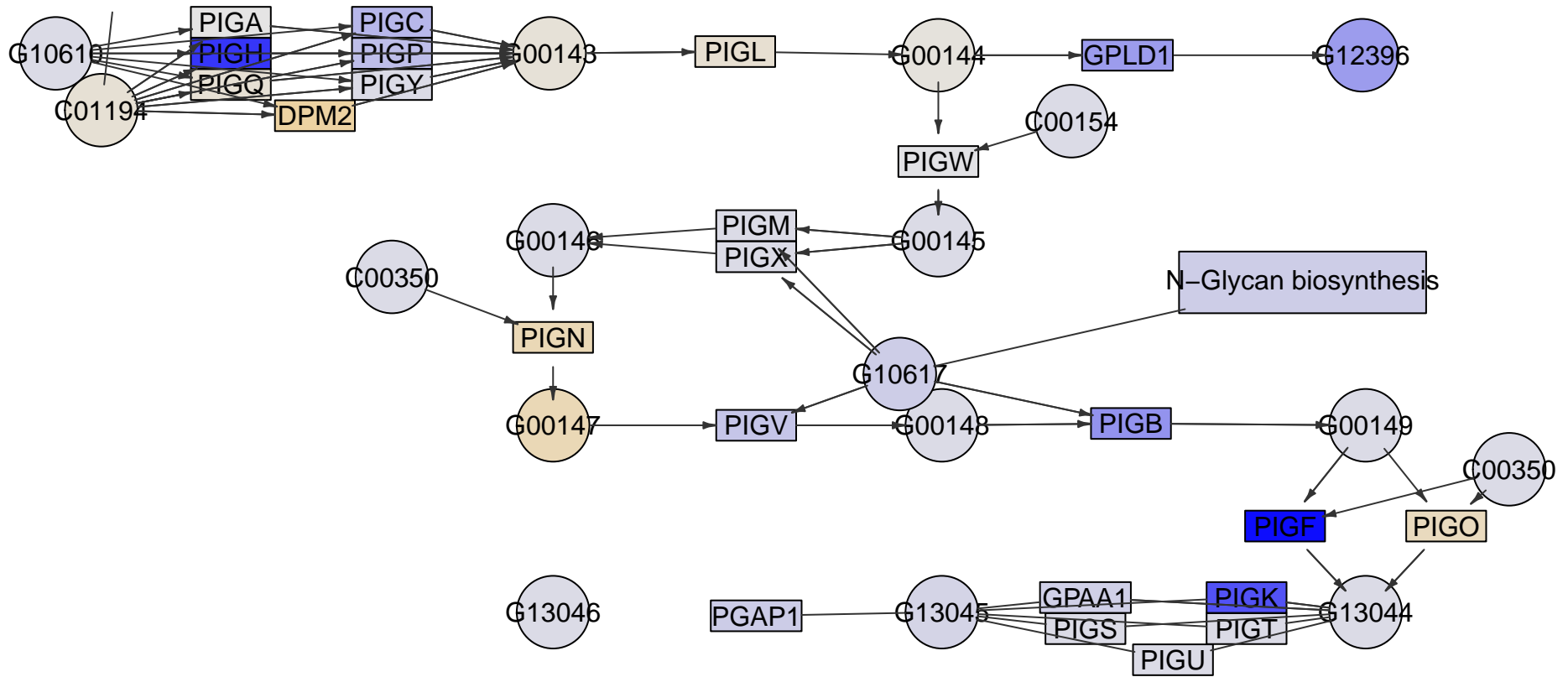

PIGK

PIGO

PIGG

PIGN

PIGZ

PIGB

PIGV

PIGM

PIGA

Glycosylphosphatidylinositol(GPI)-anchor
biosynthesis
MPI-221

Glycerophospholipid
metabolism

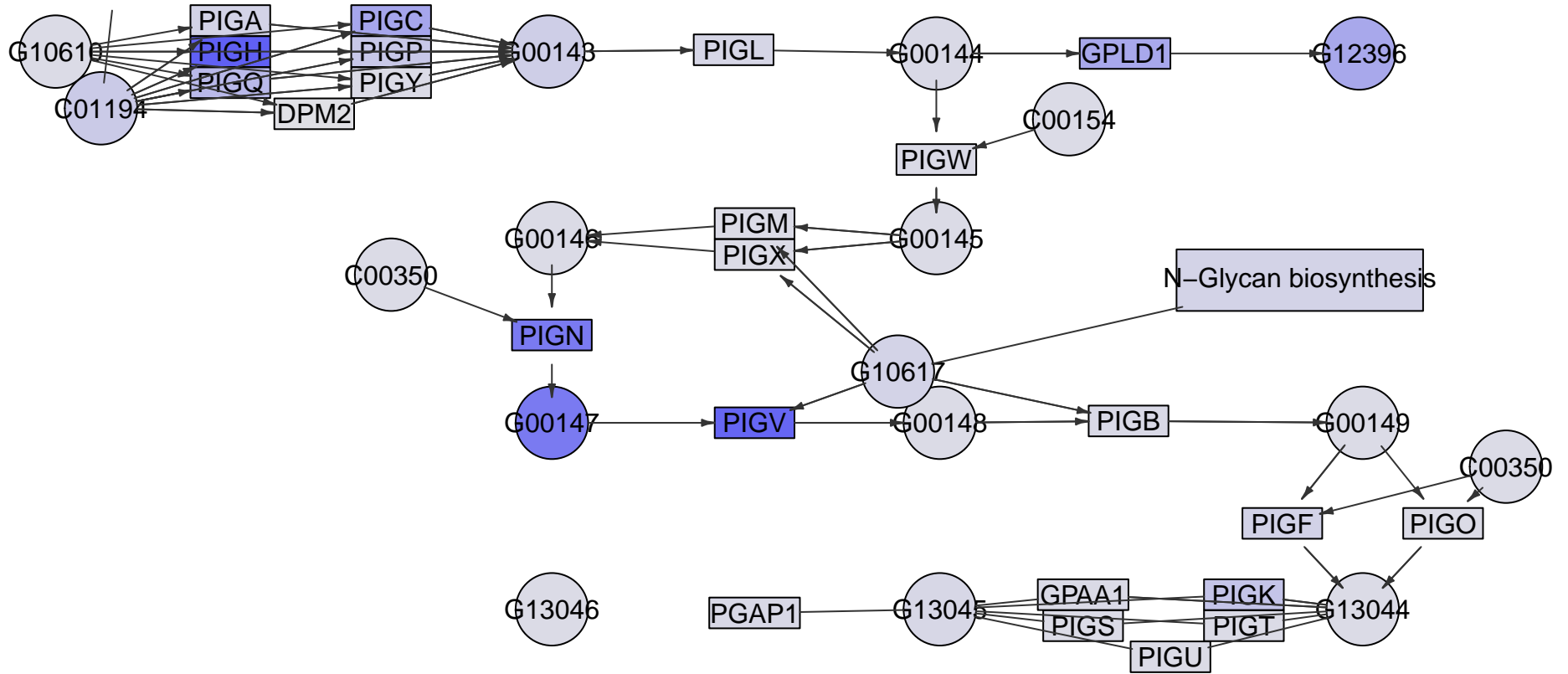

N-Glycan biosynthesis

PIGK

PIGO

PIGG

PIGN

PIGZ

PIGB

PIGV

PIGM

PIGA

Glycosylphosphatidylinositol(GPI)-anchor
biosynthesis
MPI-223a

Glycerophospholipid
metabolism

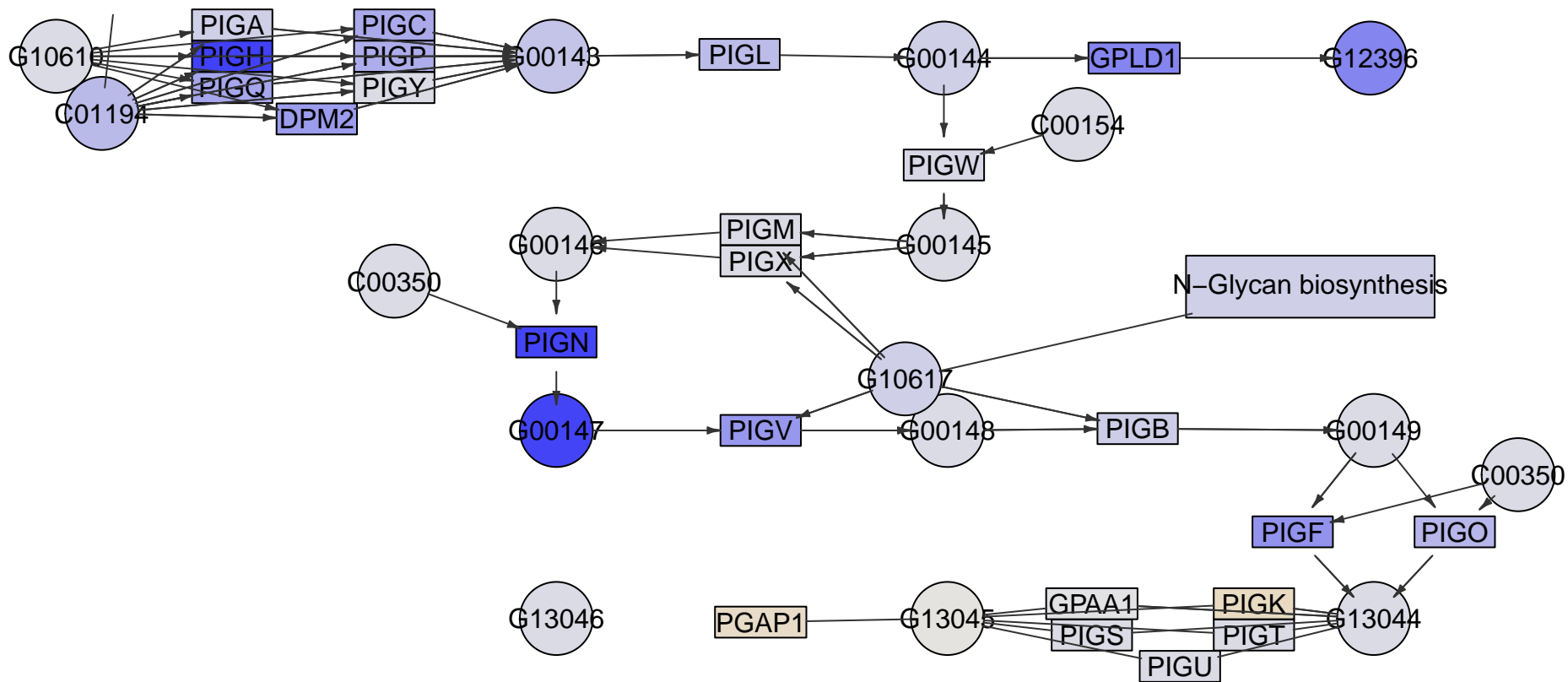

PIGK

PIGO

PIGG

PIGN

PIGZ

PIGB

PIGV

PIGM

PIGA

Glycosylphosphatidylinositol(GPI)-anchor
biosynthesis
MPI-224

Glycerophospholipid
metabolism

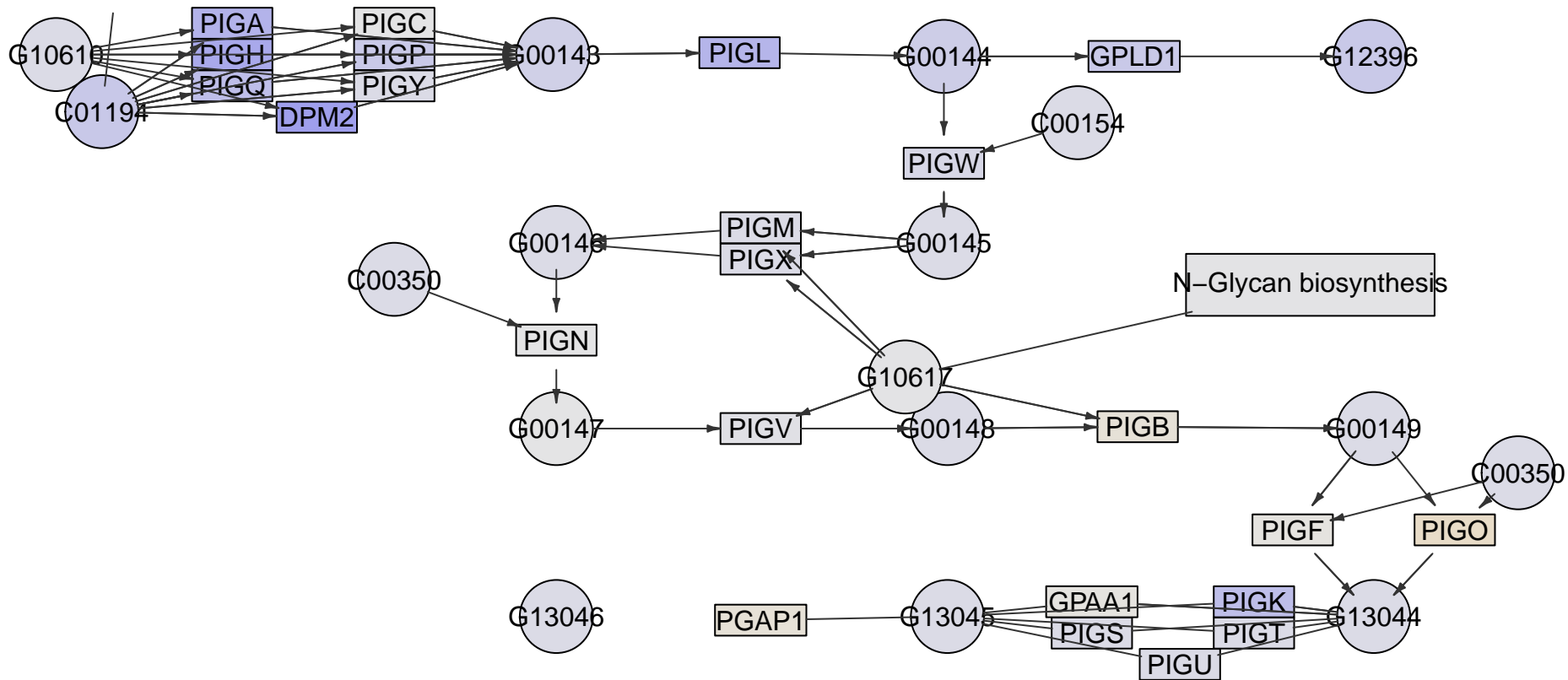

PIGK

PIGO

PIGG

PIGN

PIGZ

PIGB

PIGV

PIGM

PIGA

Glycosylphosphatidylinositol(GPI)-anchor
biosynthesis
MPI-226

Glycerophospholipid
metabolism

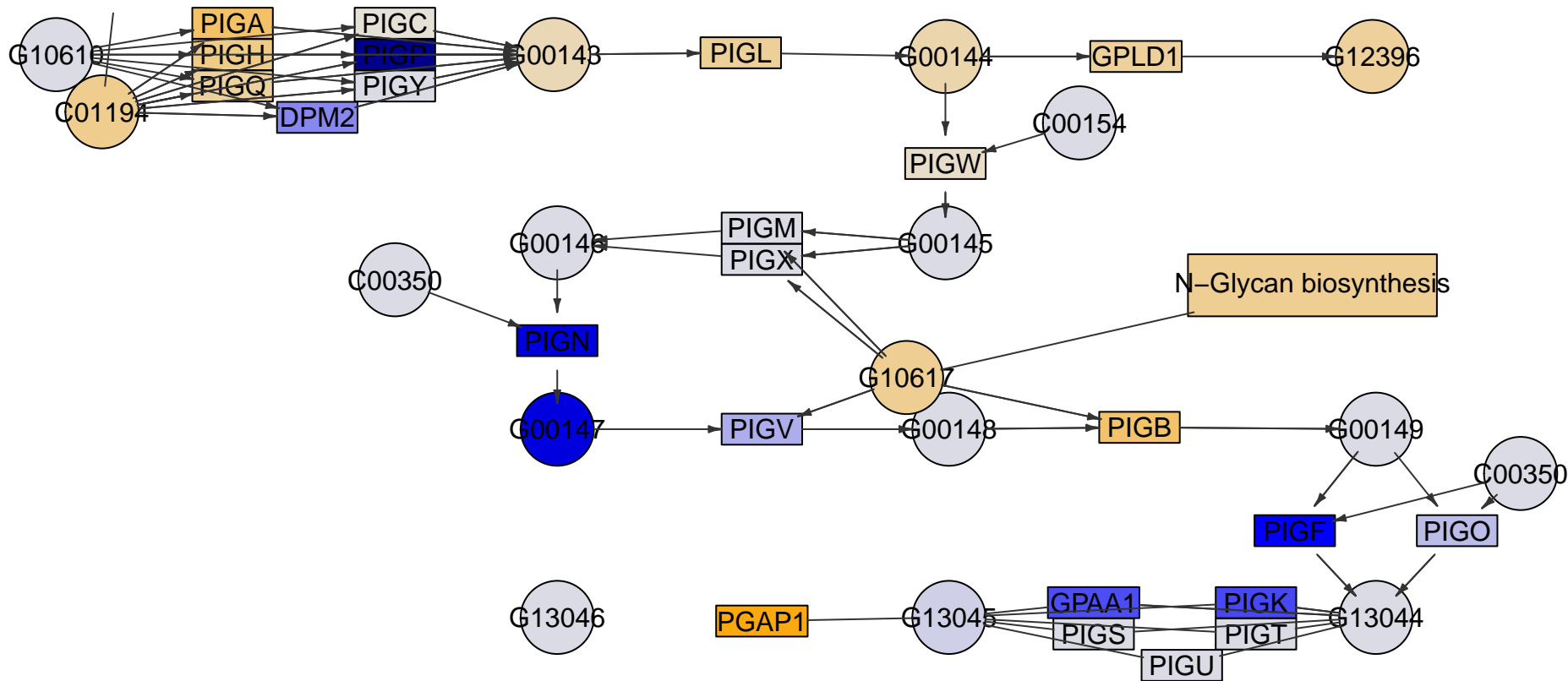

PIGK

PIGO

PIGG

PIGN

PIGZ

PIGB

PIGV

PIGM

PIGA

Glycosylphosphatidylinositol(GPI)-anchor
biosynthesis
MPI-227

Glycerophospholipid
metabolism

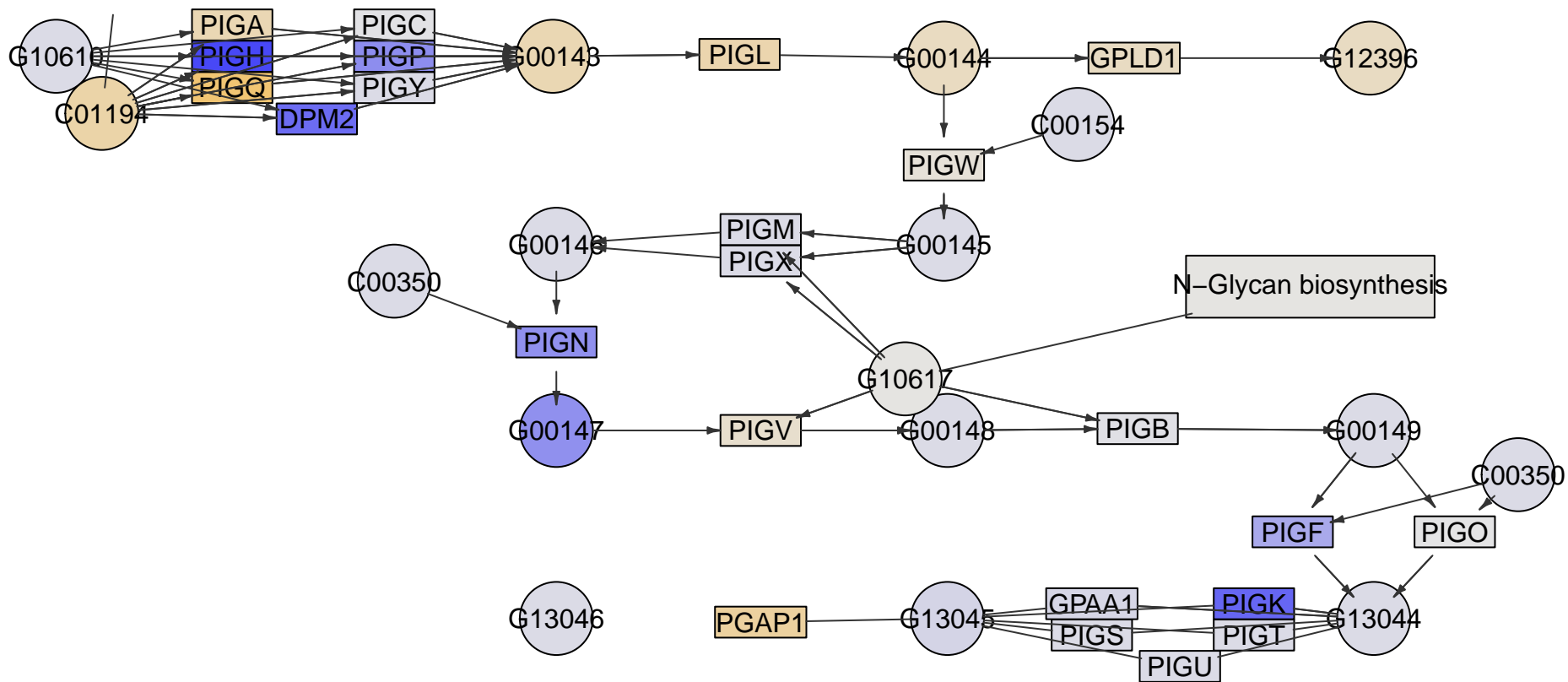

PIGK

PIGO

PIGG

PIGN

PIGZ

PIGB

PIGV

PIGM

PIGA

Glycosylphosphatidylinositol(GPI)-anchor
biosynthesis
MPI-228

Glycerophospholipid
metabolism

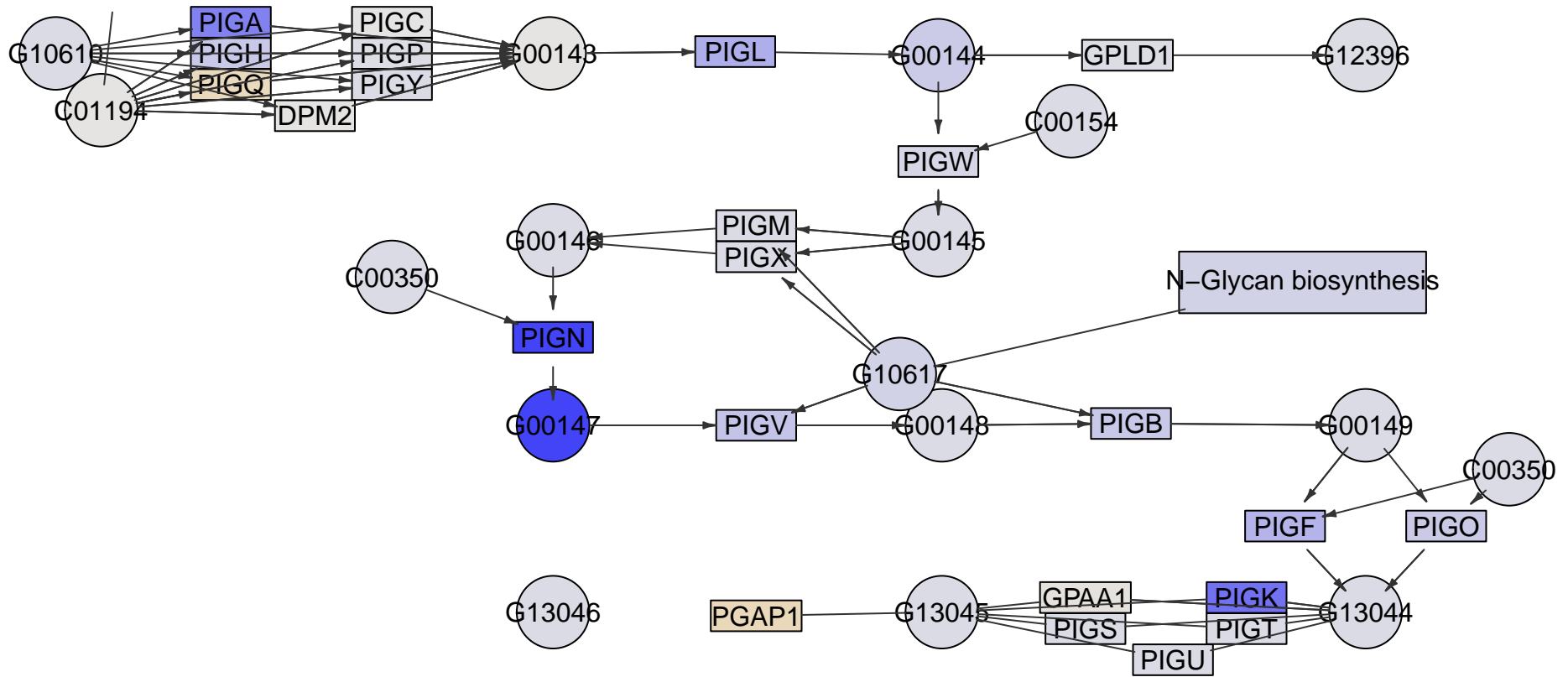

N-Glycan biosynthesis

PIGK

PIGO

PIGG

PIGN

PIGZ

PIGB

PIGV

PIGM

PIGA

Glycosylphosphatidylinositol(GPI)-anchor
biosynthesis
MPI-229

Glycerophospholipid
metabolism

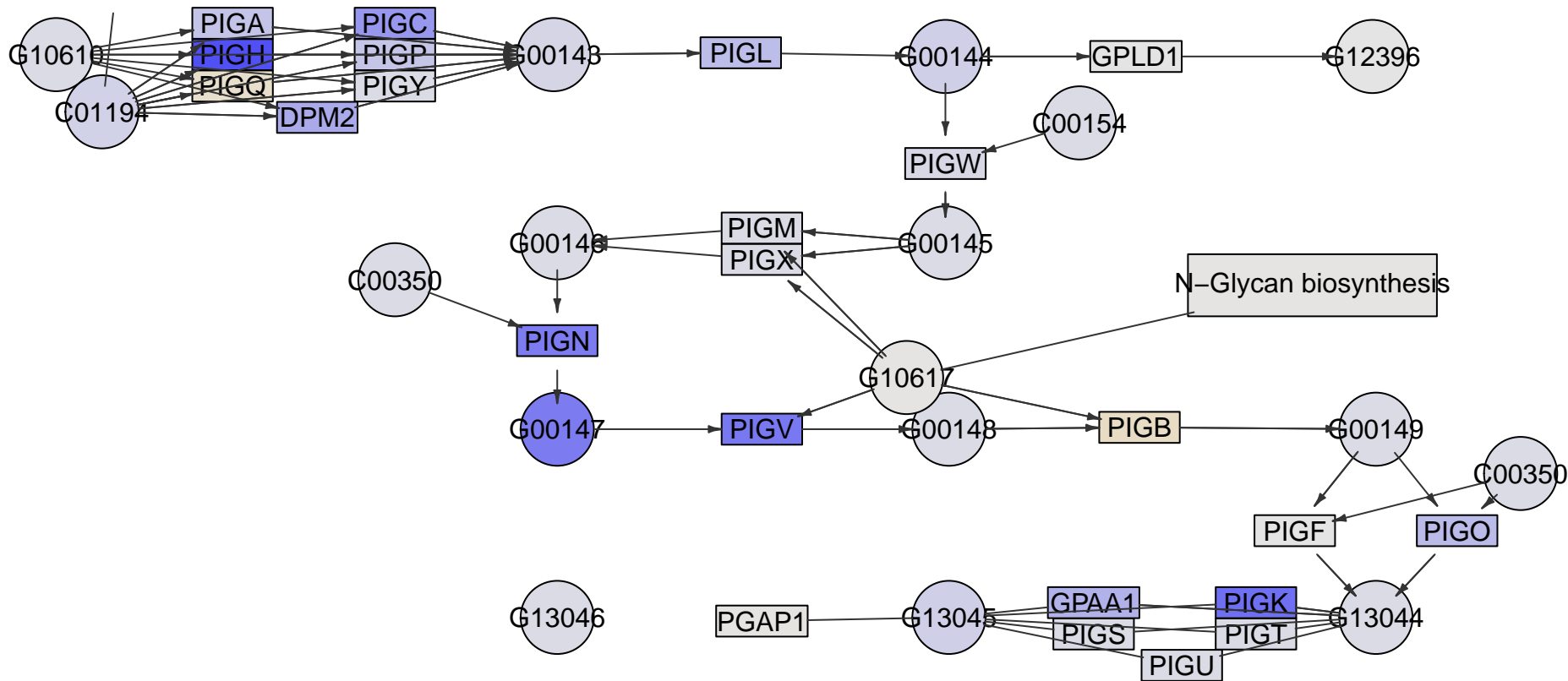

PIGK

PIGO

PIGG

PIGN

PIGZ

PIGB

PIGV

PIGM

PIGA

Glycosylphosphatidylinositol(GPI)-anchor
biosynthesis
MPI-230

Glycerophospholipid
metabolism

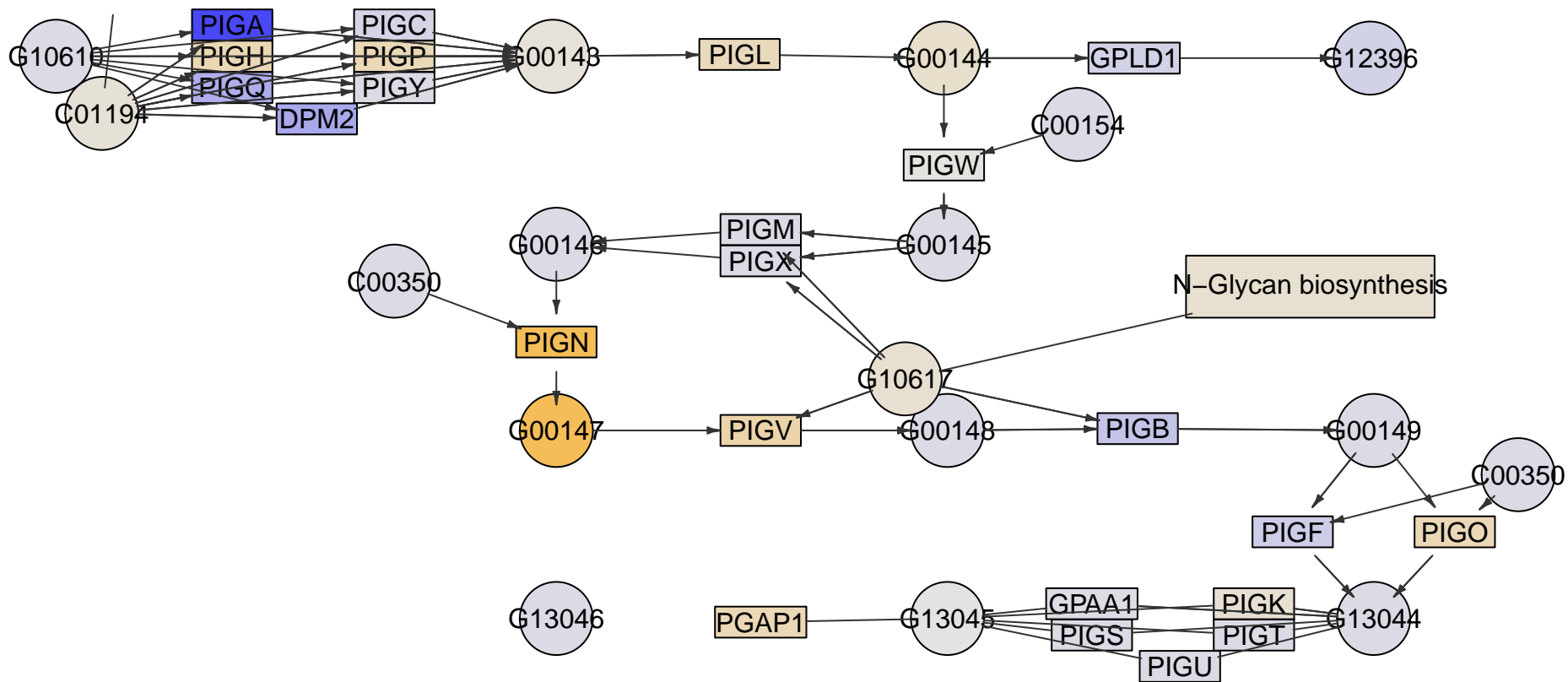

PIGK

PIGO

PIGG

PIGN

PIGZ

PIGB

PIGV

PIGM

PIGA

Glycosylphosphatidylinositol(GPI)-anchor
biosynthesis
MPI-231

Glycerophospholipid
metabolism

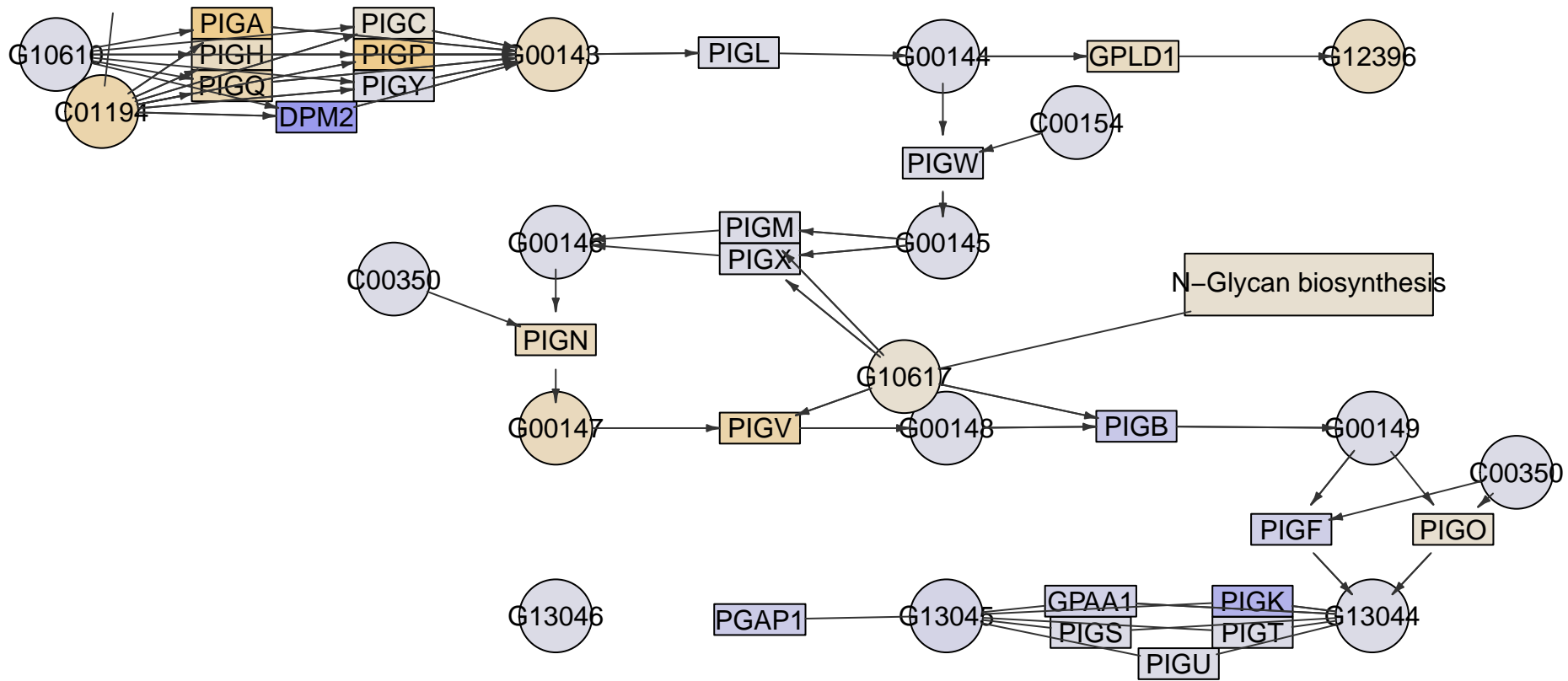

PIGK

PIGO

PIGG

PIGN

PIGZ

PIGB

PIGV

PIGM

PIGA

Glycosylphosphatidylinositol(GPI)-anchor
biosynthesis
MPI-232

Glycerophospholipid
metabolism

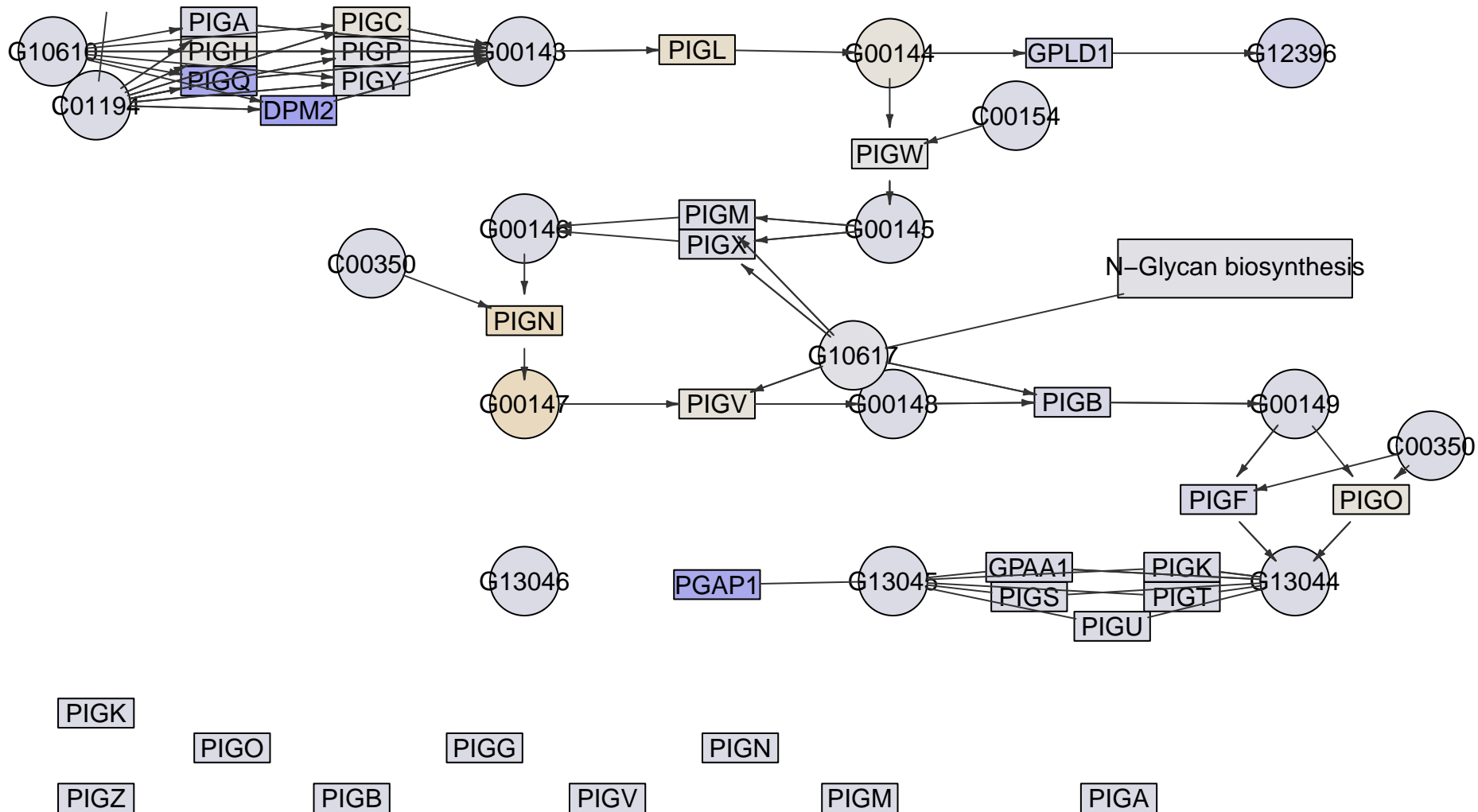

Glycosylphosphatidylinositol(GPI)-anchor
biosynthesis
MPI-233

Glycerophospholipid
metabolism

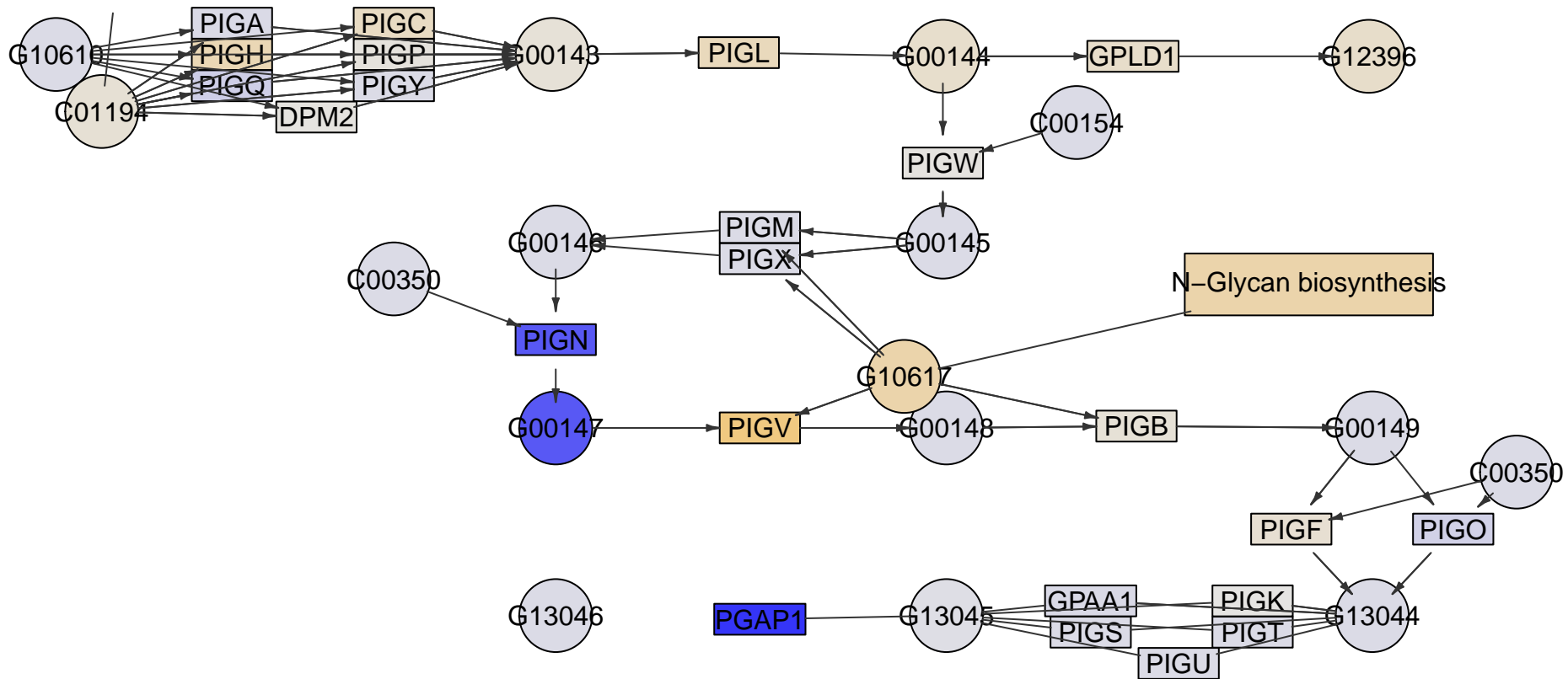

PIGK

PIGO

PIGG

PIGN

PIGZ

PIGB

PIGV

PIGM

PIGA

Glycosylphosphatidylinositol(GPI)-anchor
biosynthesis
MPI-234

Glycerophospholipid
metabolism

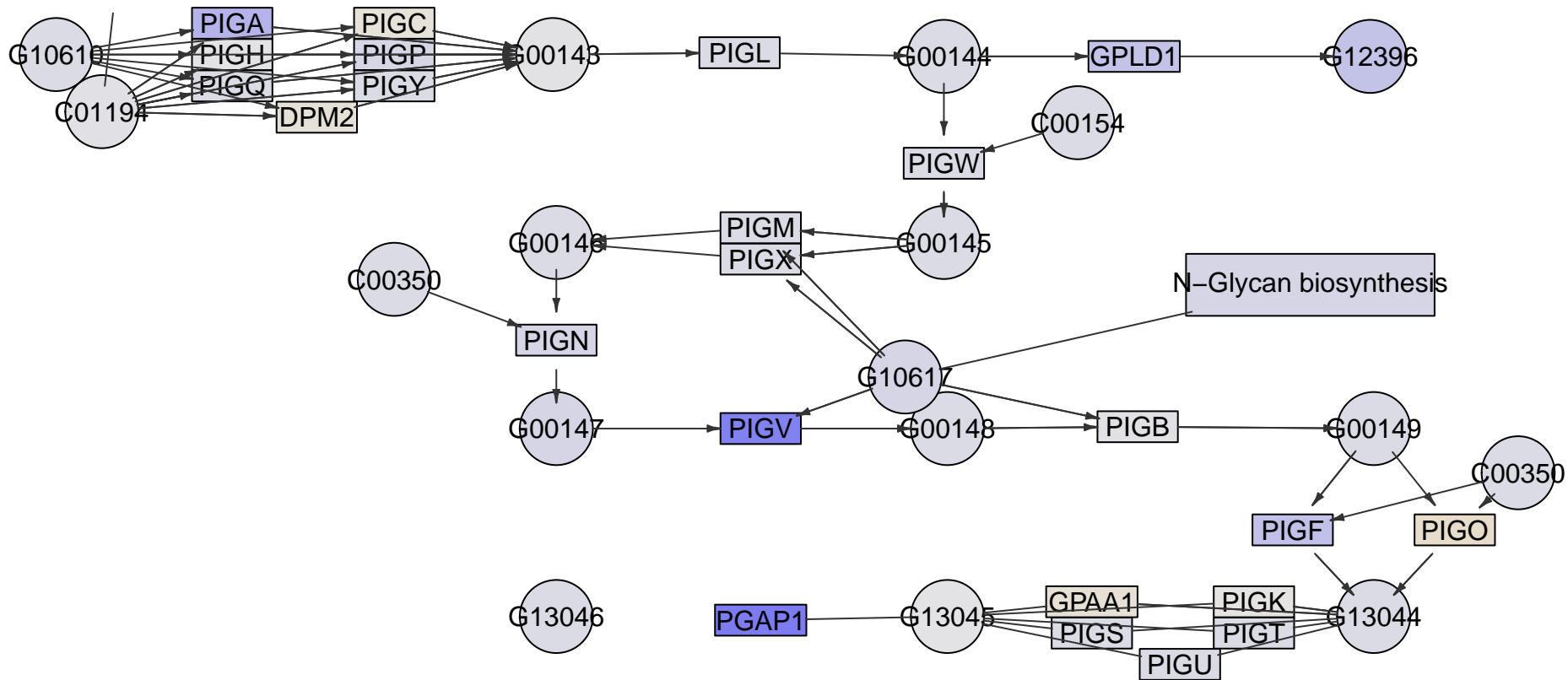

N-Glycan biosynthesis

PIGK

PIGO

PIGG

PIGN

PIGZ

PIGB

PIGV

PIGM

PIGA

Glycosylphosphatidylinositol(GPI)-anchor
biosynthesis
MPI-235

Glycerophospholipid
metabolism

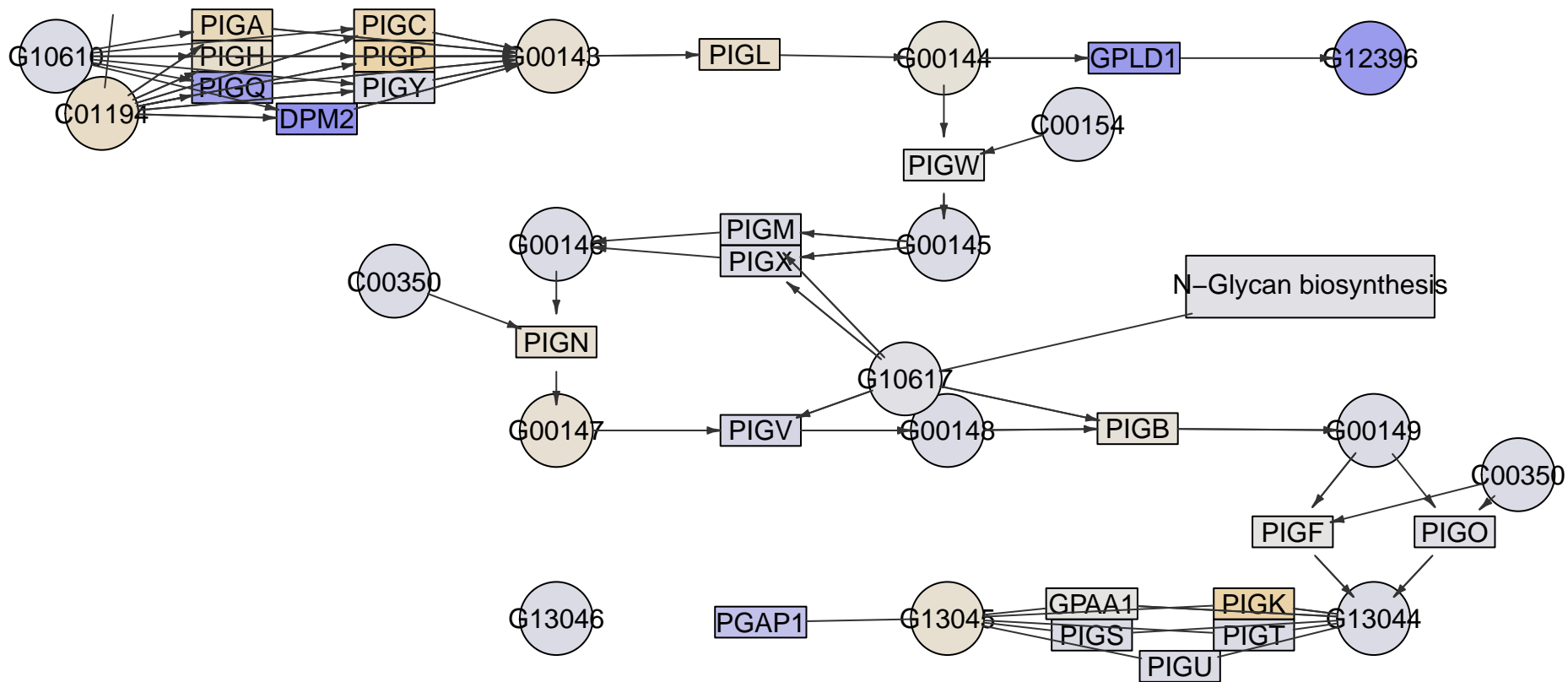

PIGK

PIGO

PIGG

PIGN

PIGZ

PIGB

PIGV

PIGM

PIGA

Glycosylphosphatidylinositol(GPI)-anchor
biosynthesis
MPI-236

Glycerophospholipid
metabolism

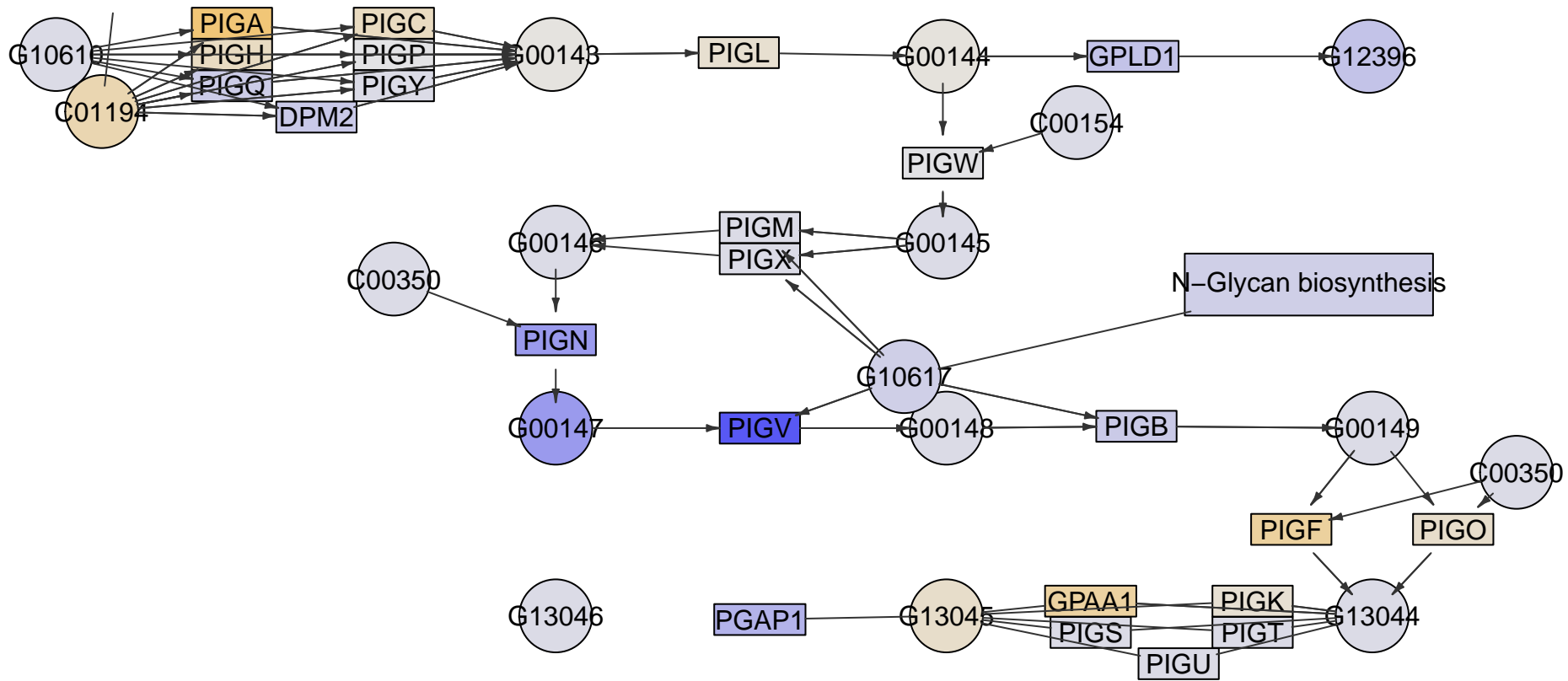

PIGK

PIGO

PIGG

PIGN

PIGZ

PIGB

PIGV

PIGM

PIGA

Glycosylphosphatidylinositol(GPI)-anchor
biosynthesis
MPI-237

Glycerophospholipid
metabolism

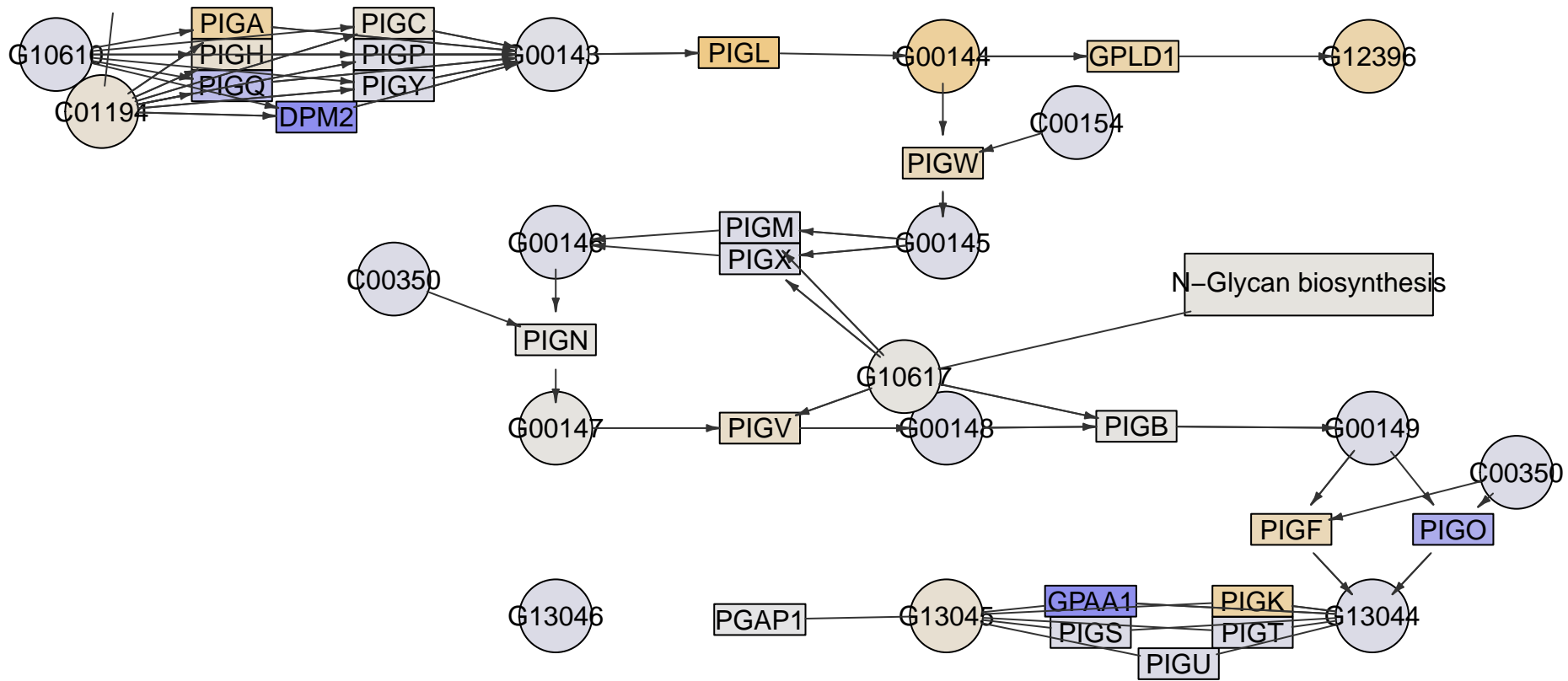

N-Glycan biosynthesis

PIGK

PIGO

PIGG

PIGN

PIGZ

PIGB

PIGV

PIGM

PIGA

Glycosylphosphatidylinositol(GPI)-anchor
biosynthesis
MPI-239

Glycerophospholipid
metabolism

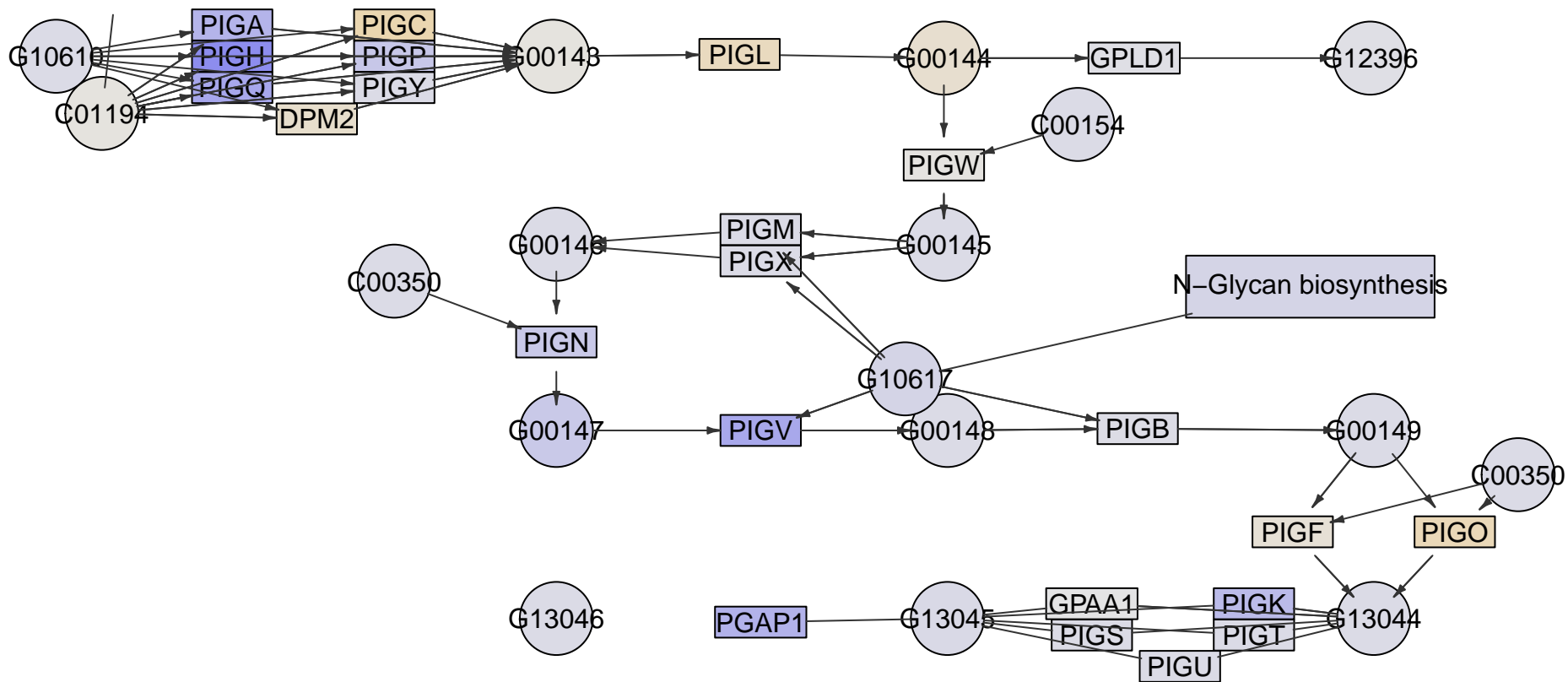

PIGK

PIGO

PIGG

PIGN

PIGZ

PIGB

PIGV

PIGM

PIGA

Glycosylphosphatidylinositol(GPI)-anchor
biosynthesis
MPI-241

Glycerophospholipid
metabolism

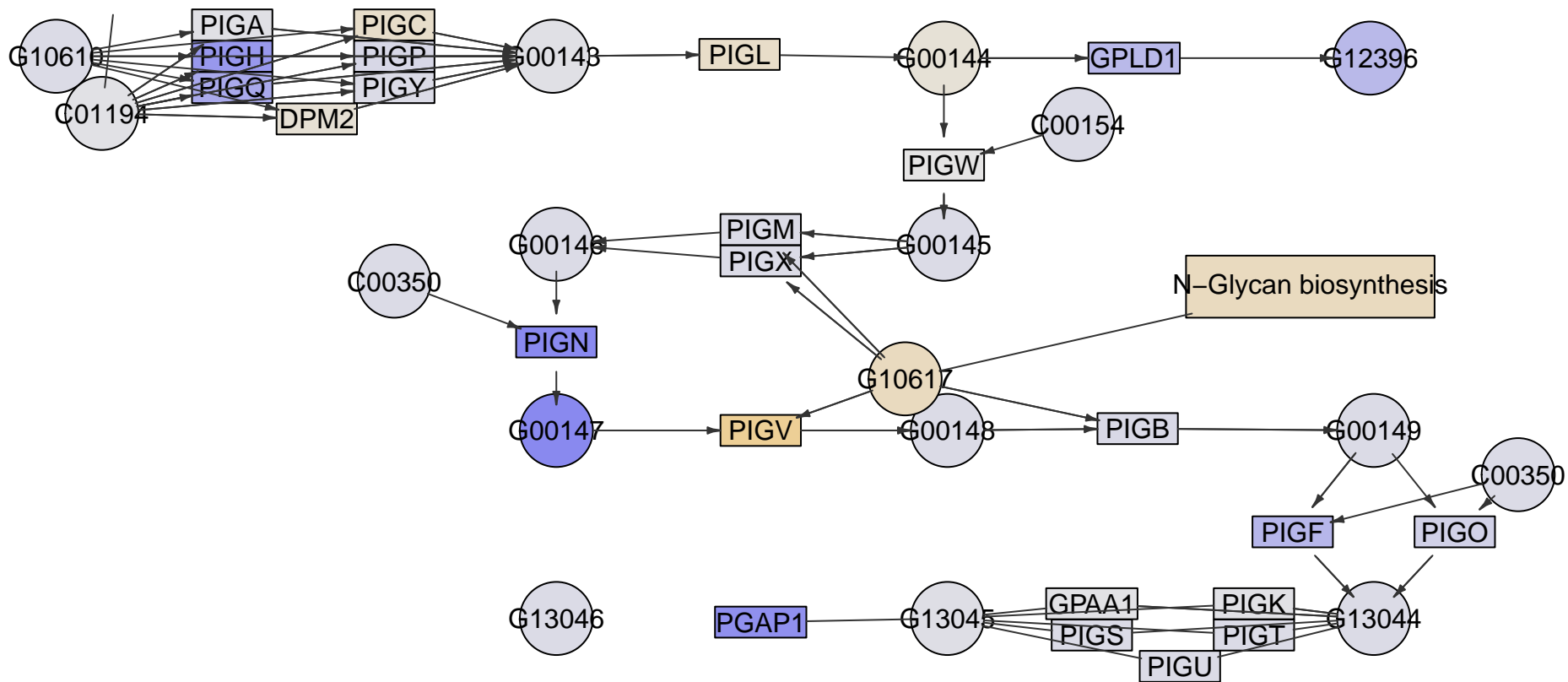

PIGK

PIGO

PIGG

PIGN

PIGZ

PIGB

PIGV

PIGM

PIGA

Glycosylphosphatidylinositol(GPI)-anchor
biosynthesis
MPI-243

Glycerophospholipid
metabolism

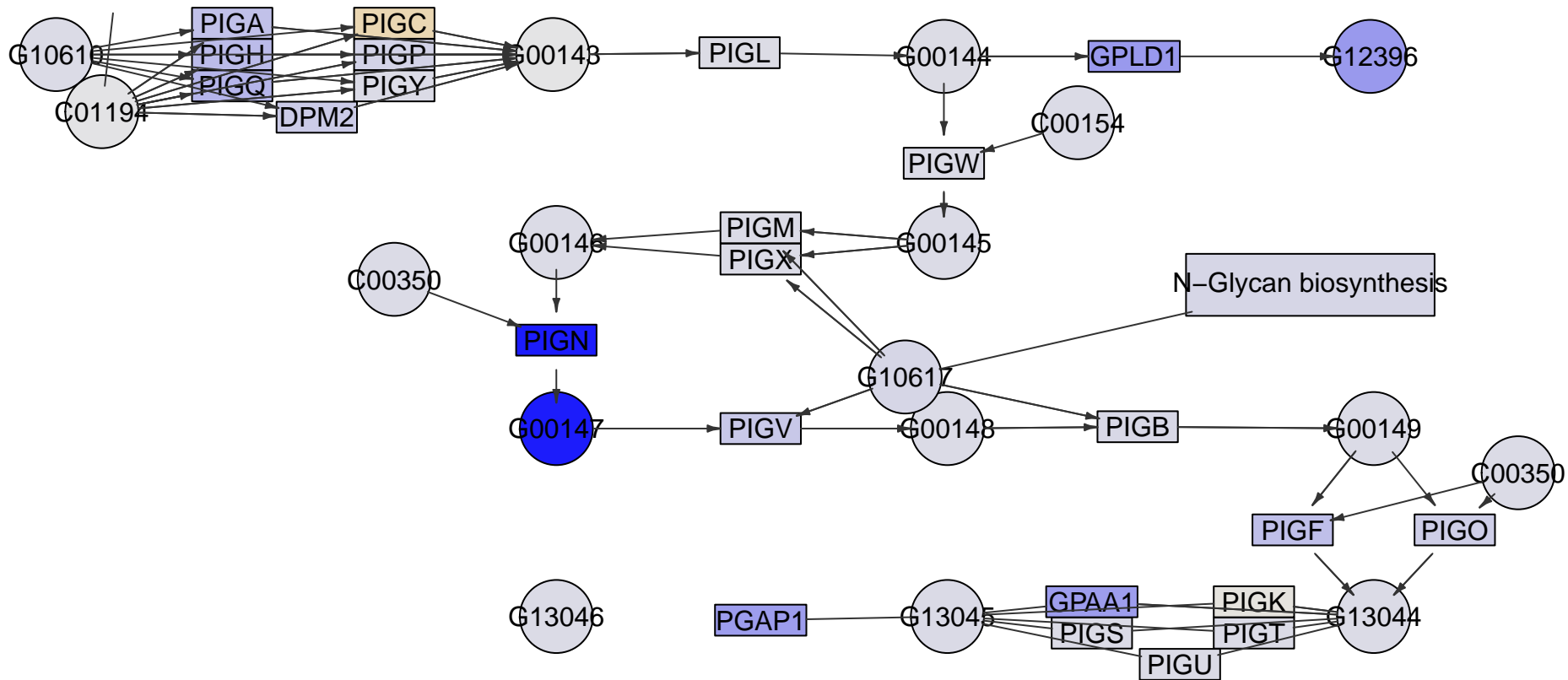

PIGK

PIGO

PIGG

PIGN

PIGZ

PIGB

PIGV

PIGM

PIGA

Glycosylphosphatidylinositol(GPI)-anchor
biosynthesis
MPI-244

Glycerophospholipid
metabolism

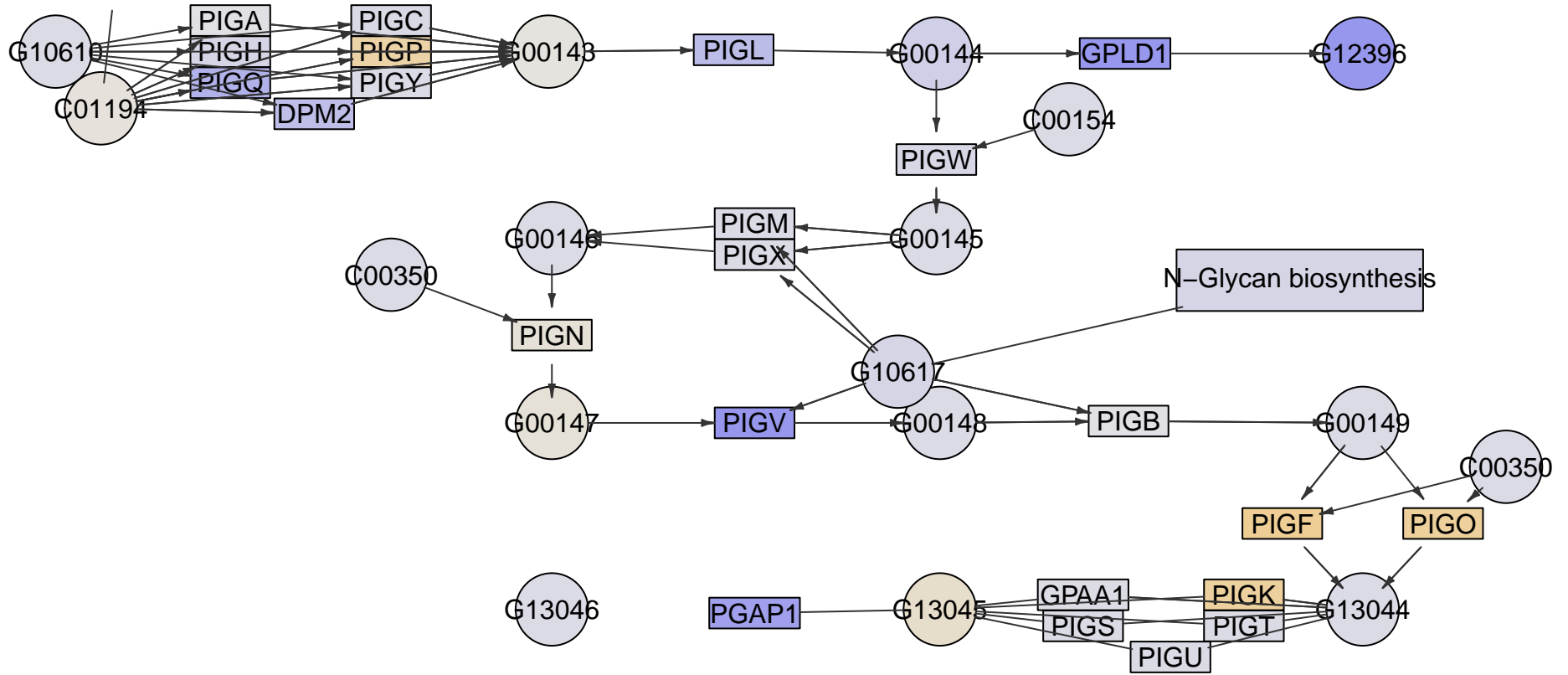

PIGK

PIGO

PIGG

PIGN

PIGZ

PIGB

PIGV

PIGM

PIGA

Glycosylphosphatidylinositol(GPI)-anchor
biosynthesis
MPI-246

Glycerophospholipid
metabolism

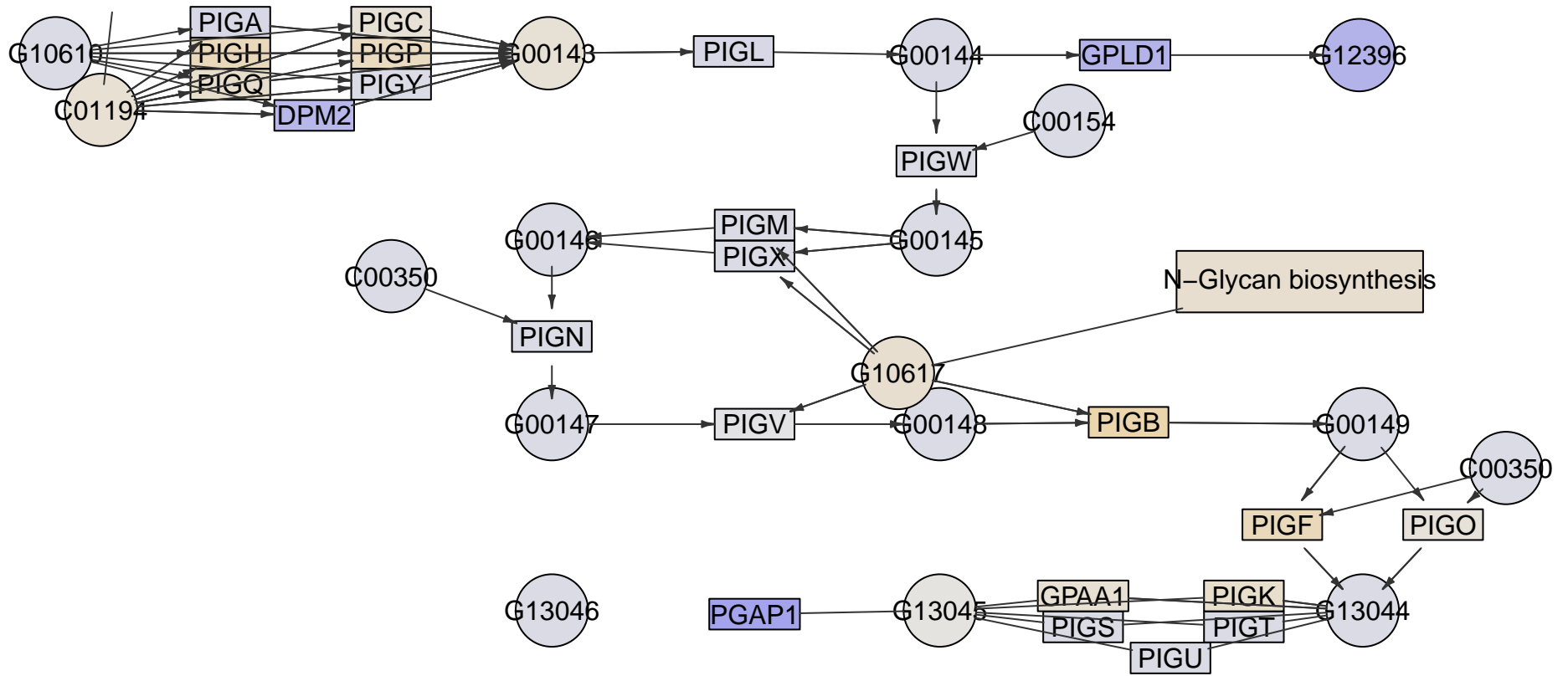

PIGK

PIGO

PIGG

PIGN

PIGZ

PIGB

PIGV

PIGM

PIGA

Glycosylphosphatidylinositol(GPI)-anchor
biosynthesis
MPI-247

Glycerophospholipid
metabolism

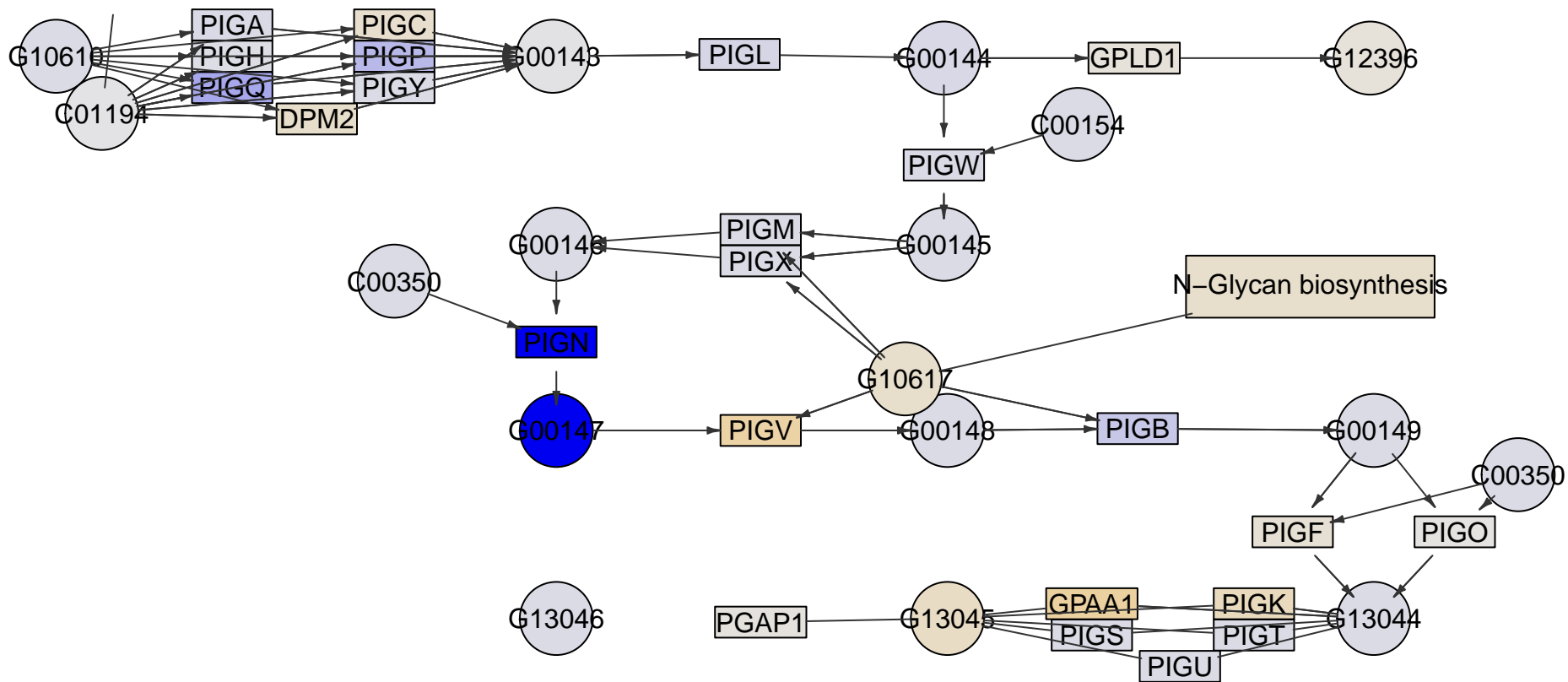

PIGK

PIGO

PIGG

PIGN

PIGZ

PIGB

PIGV

PIGM

PIGA

Glycosylphosphatidylinositol(GPI)-anchor
biosynthesis
MPI-251

Glycerophospholipid
metabolism

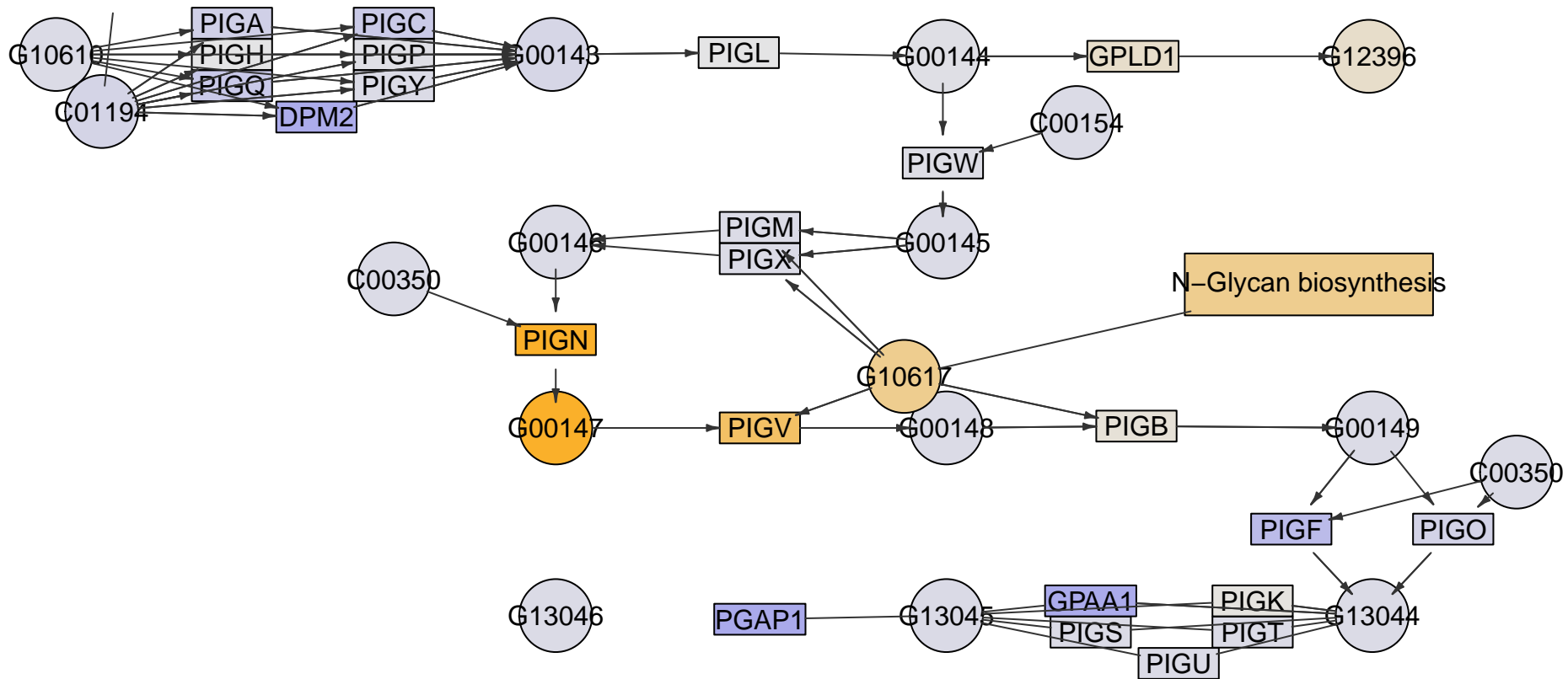

N-Glycan biosynthesis

PIGK

PIGO

PIGG

PIGN

PIGZ

PIGB

PIGV

PIGM

PIGA

Glycosylphosphatidylinositol(GPI)-anchor
biosynthesis
MPI-255

Glycerophospholipid
metabolism

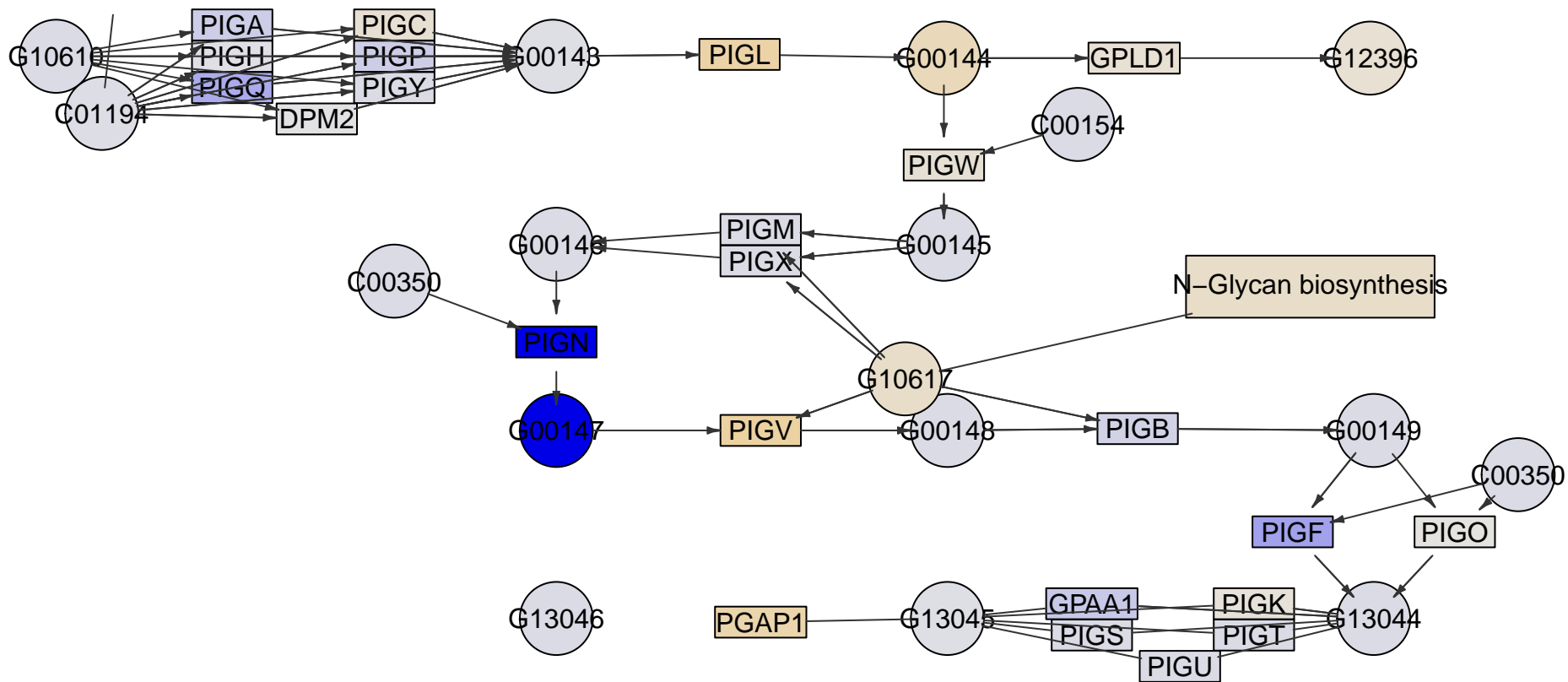

PIGK

PIGO

PIGG

PIGN

PIGZ

PIGB

PIGV

PIGM

PIGA

Glycosylphosphatidylinositol(GPI)-anchor
biosynthesis
MPI-223b

Glycerophospholipid
metabolism

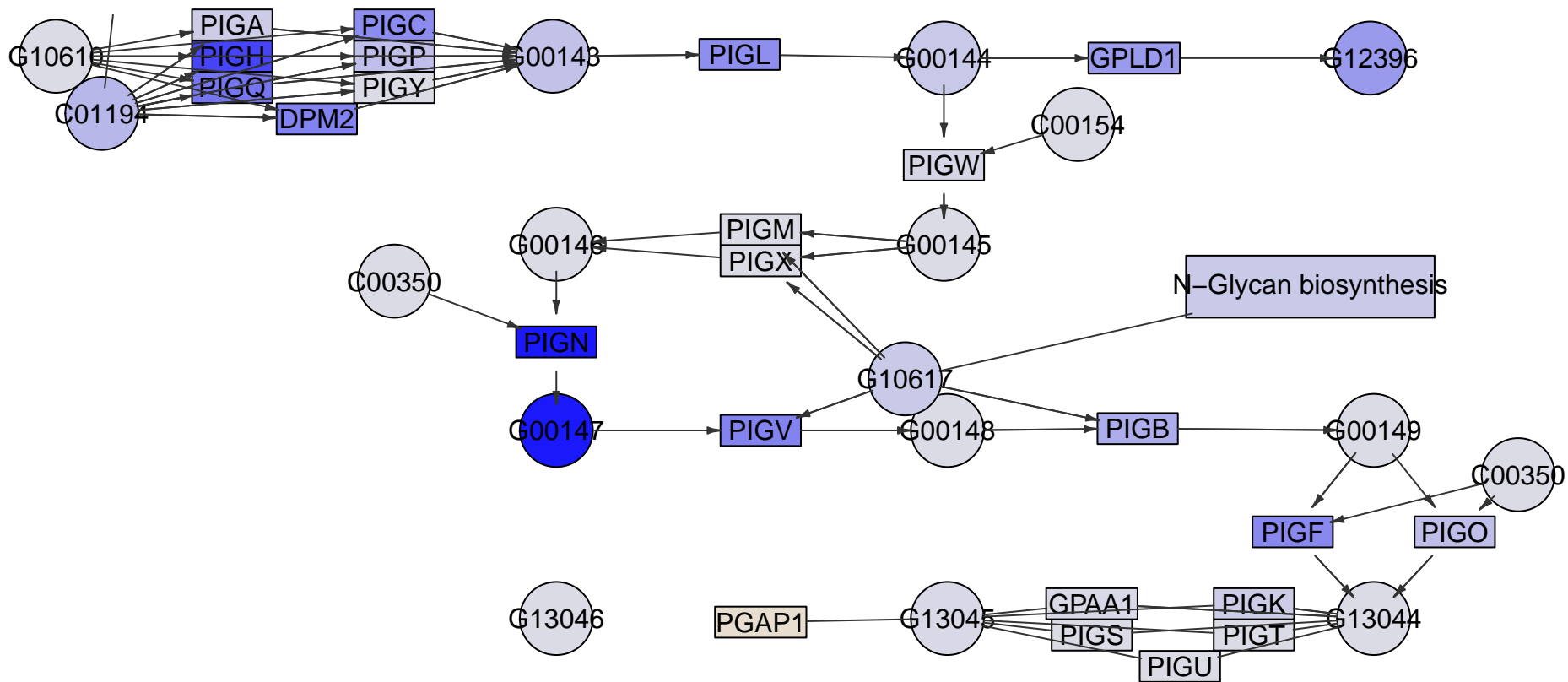

PIGK

PIGO

PIGG

PIGN

PIGZ

PIGB

PIGV

PIGM

PIGA