

GABAergic synapse

all genes

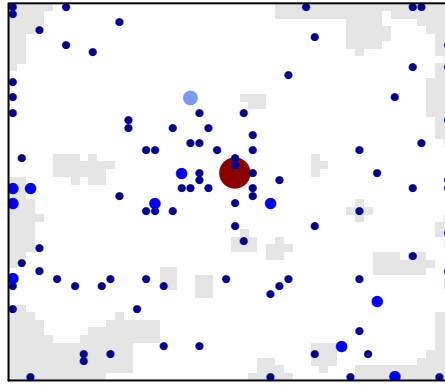

maximum = 8

sink node genes

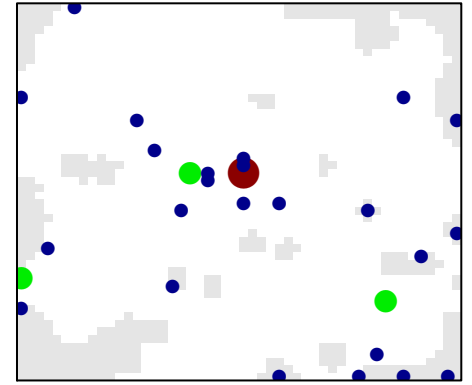

maximum = 3

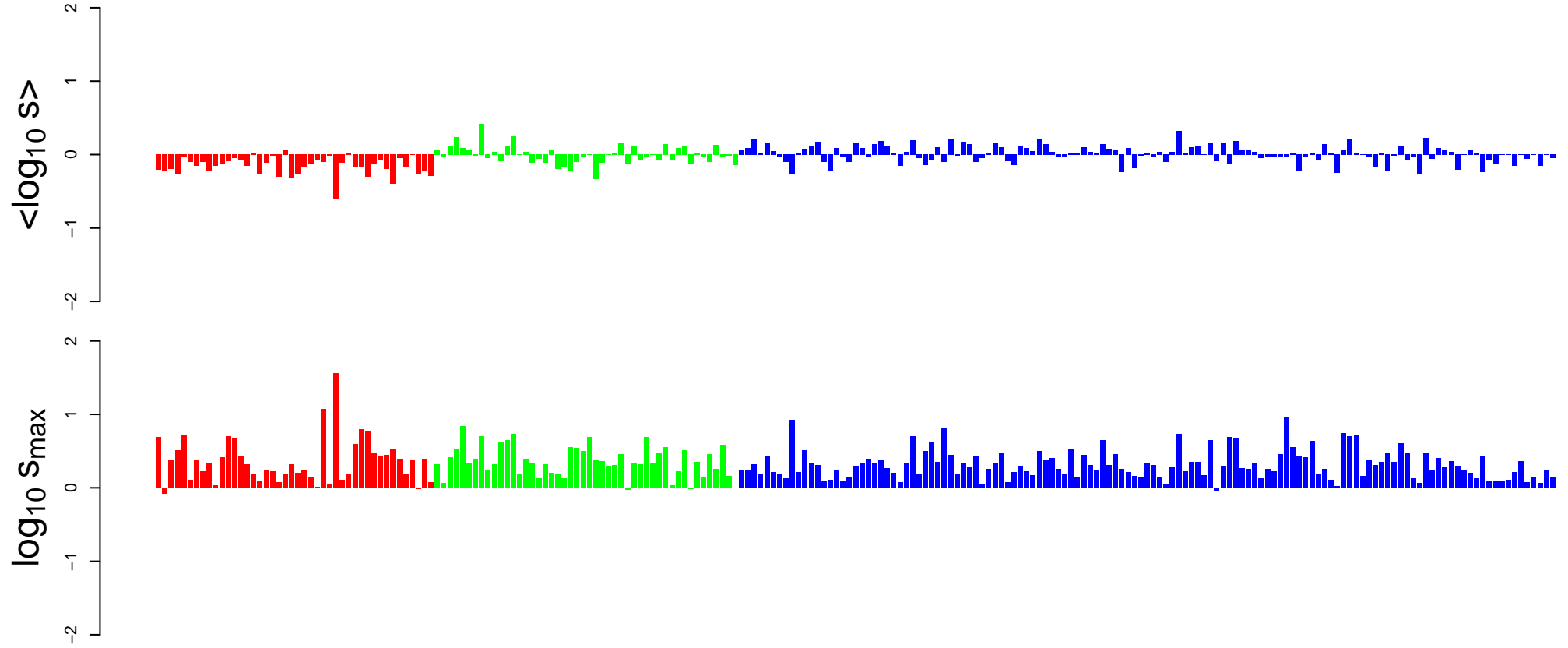

GABAergic synapse
(genes with data)

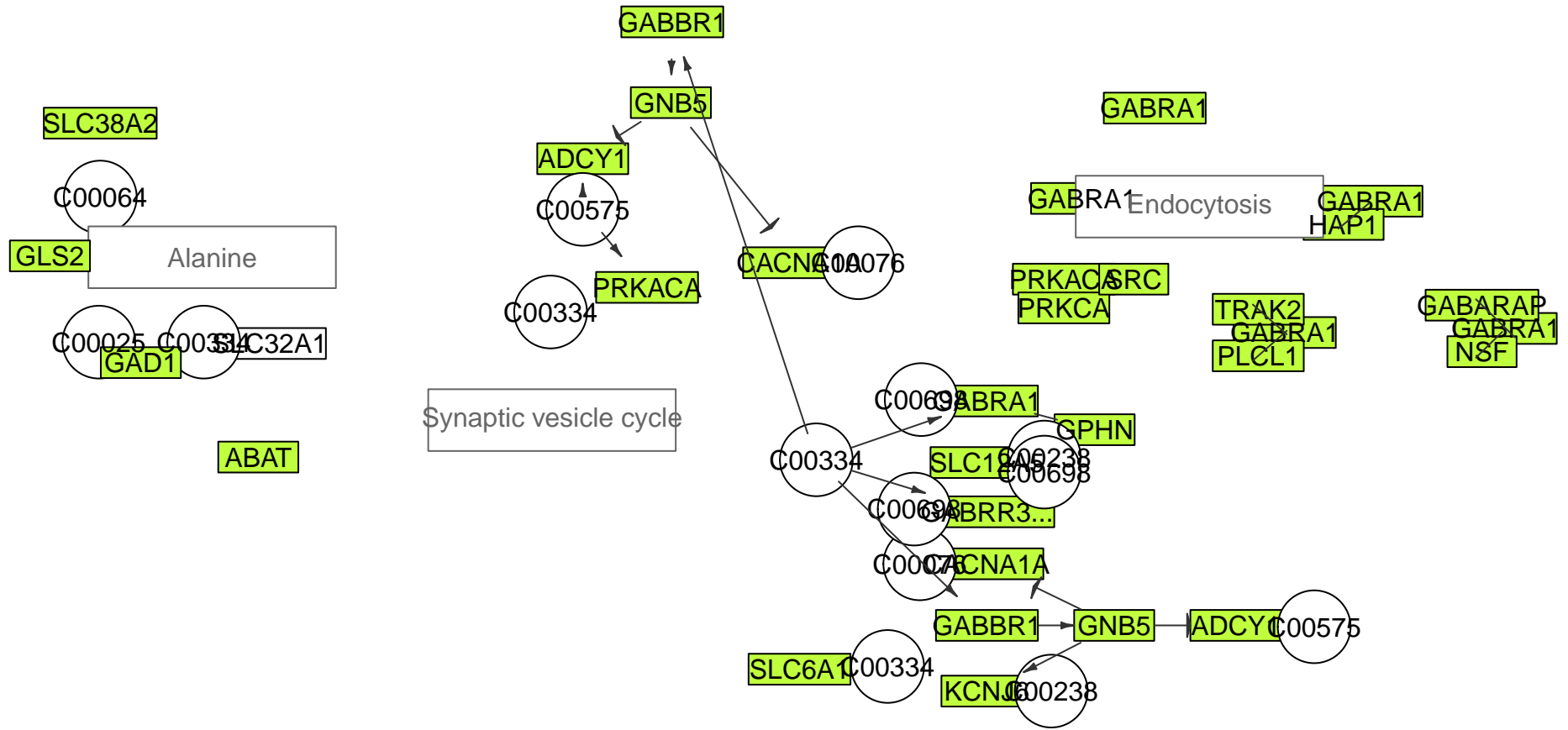
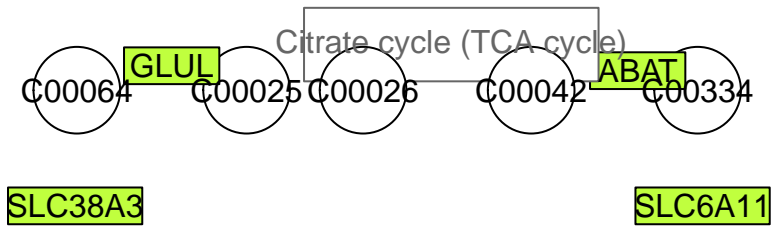

GABAergic synapse
(sink nodes)

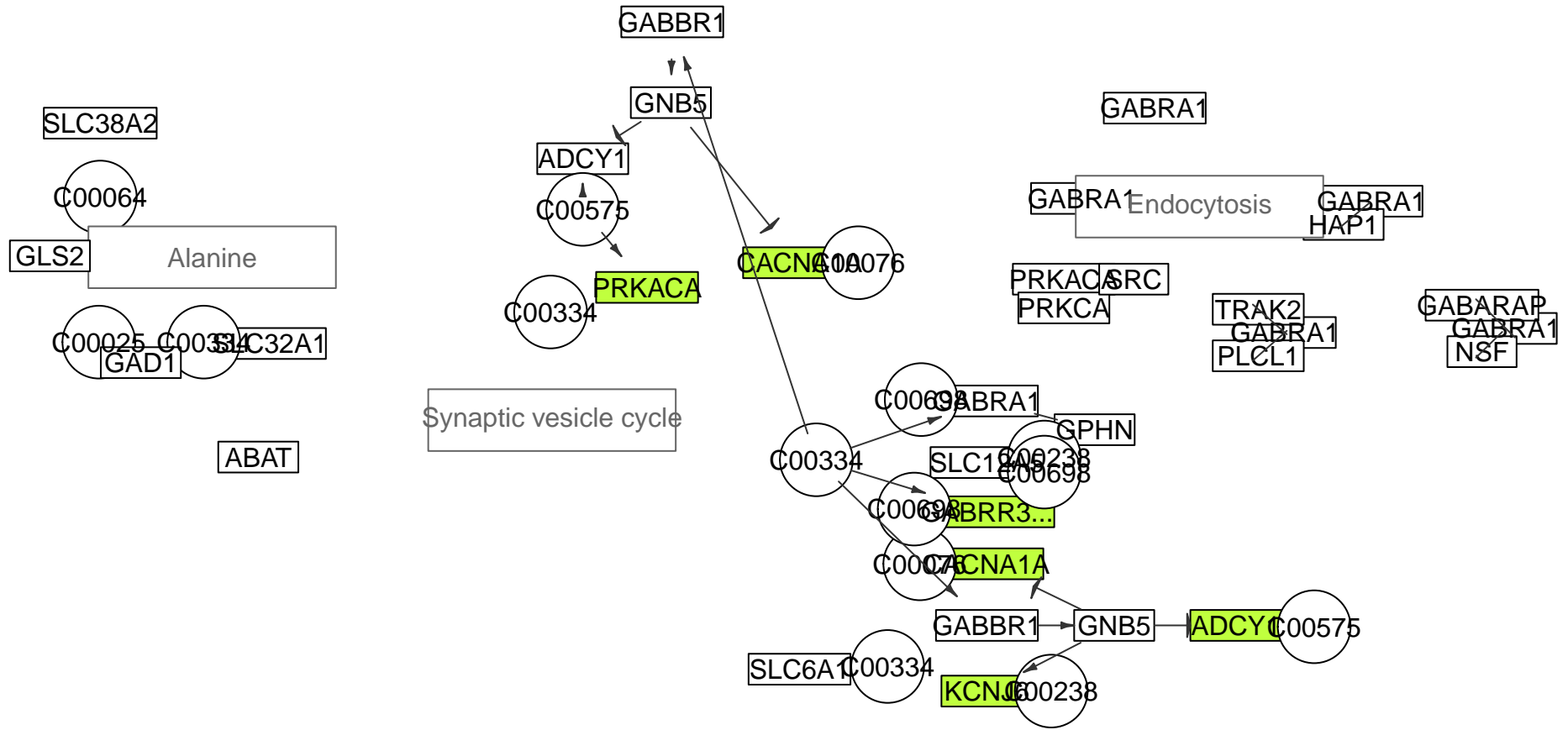
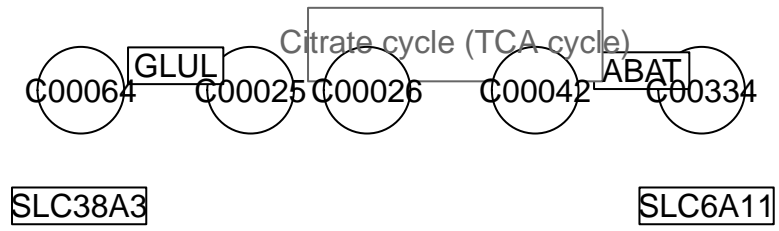

GABAergic synapse
MPI-001

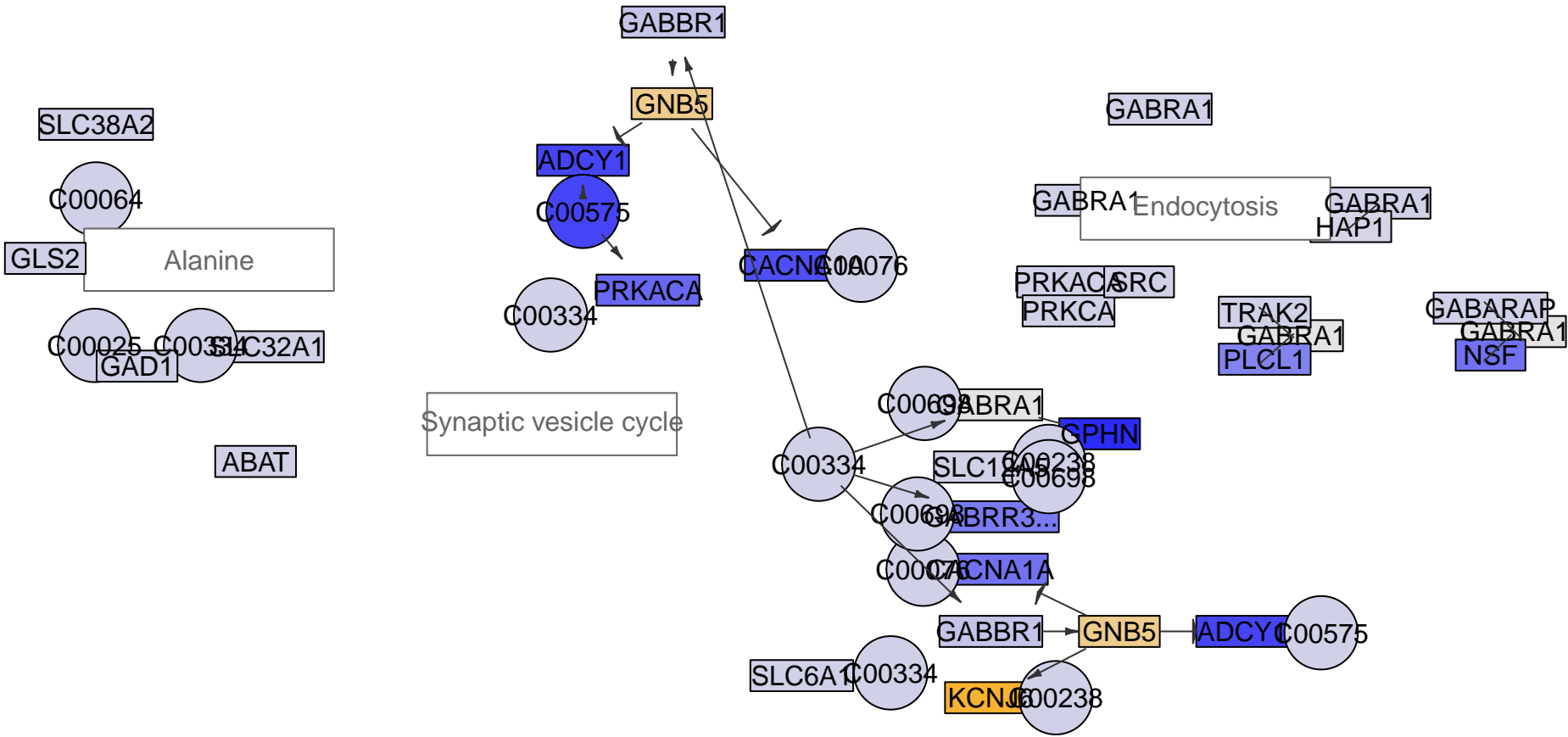
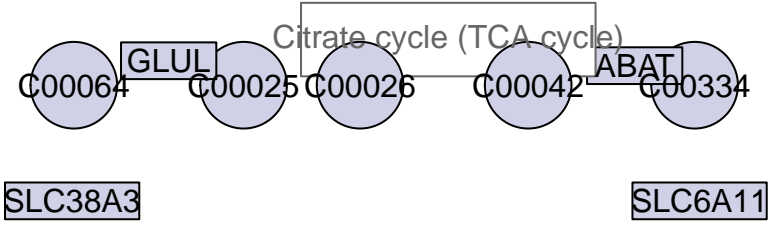

GABAergic synapse MPI-002

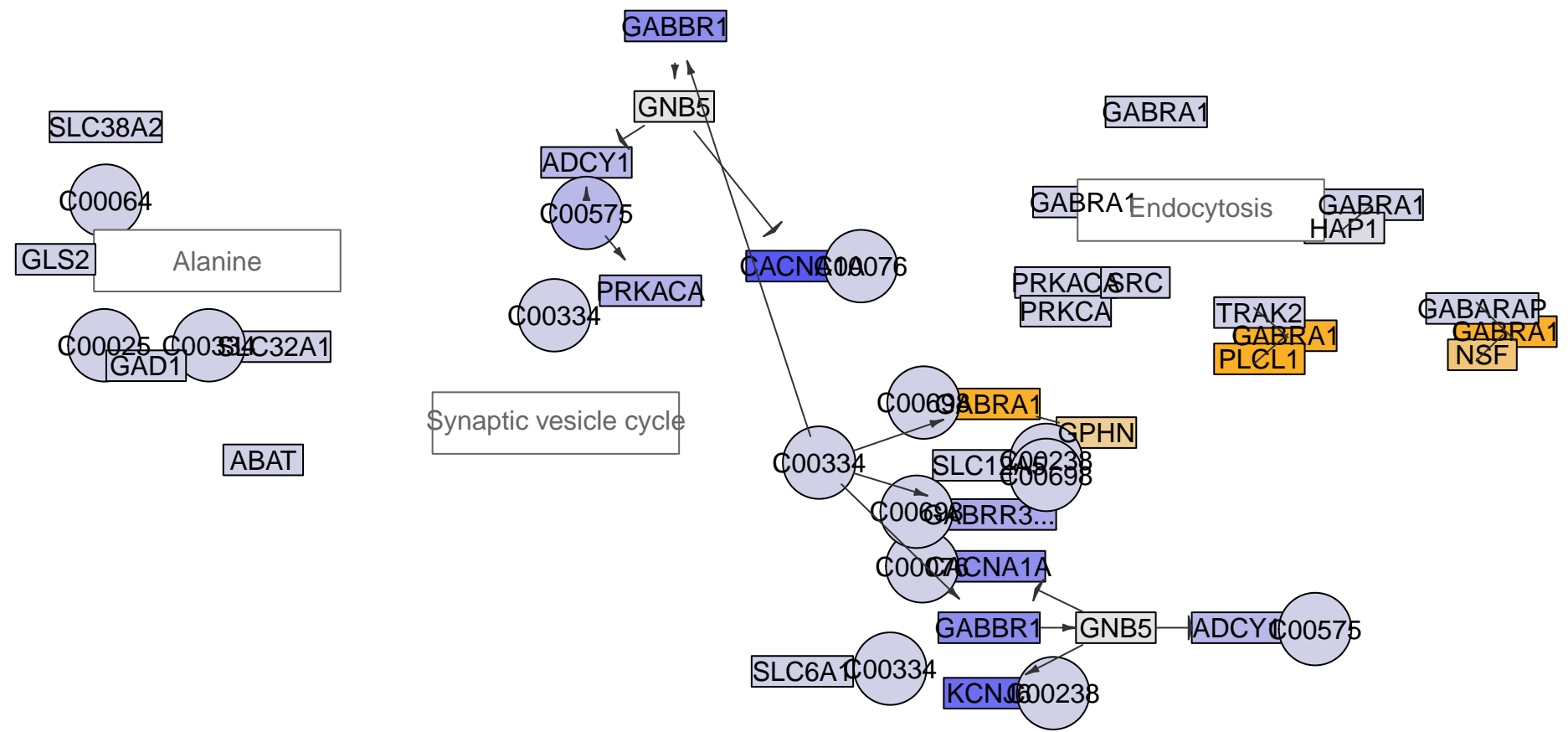

GABAergic synapse
MPI-003

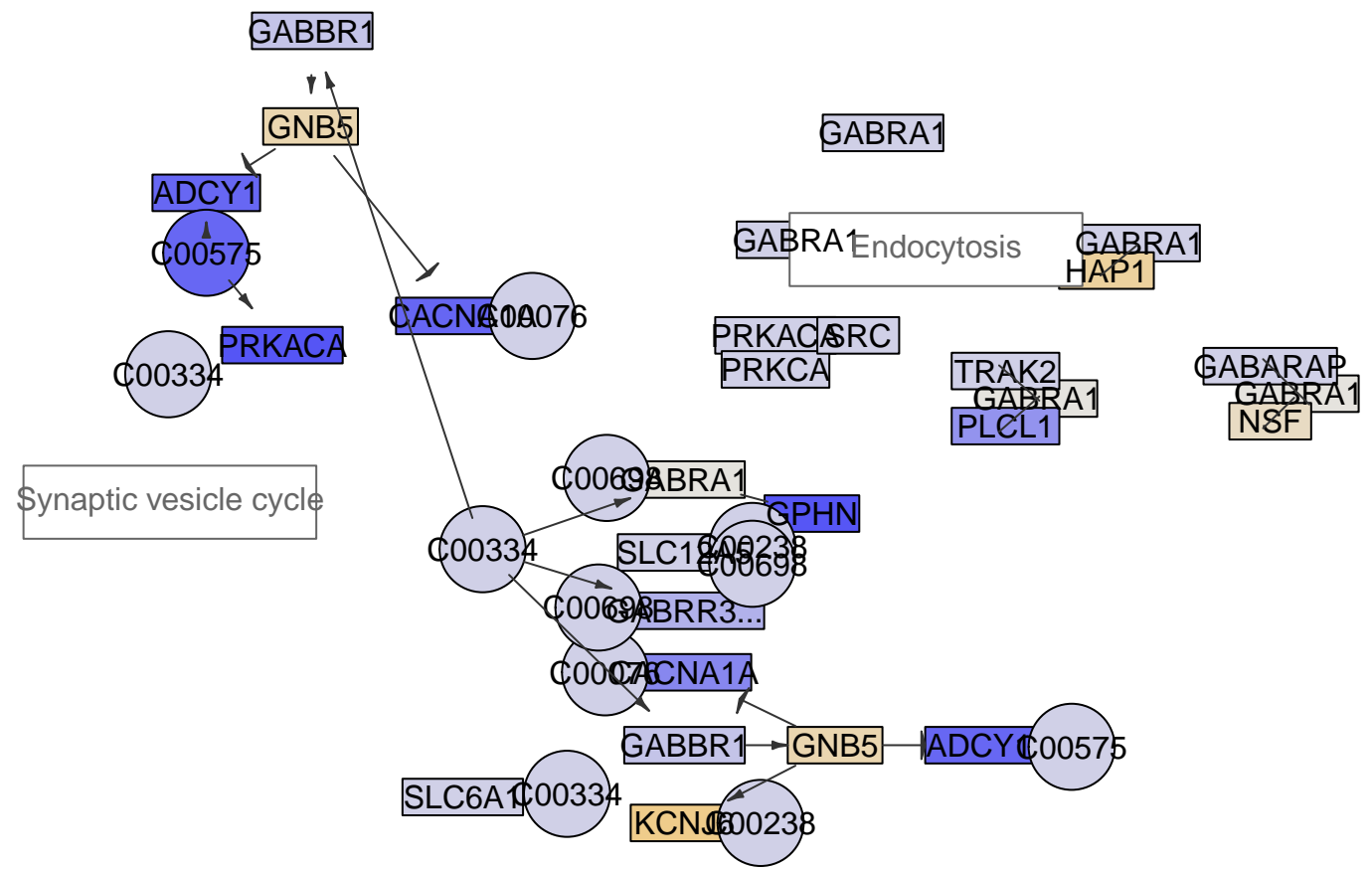
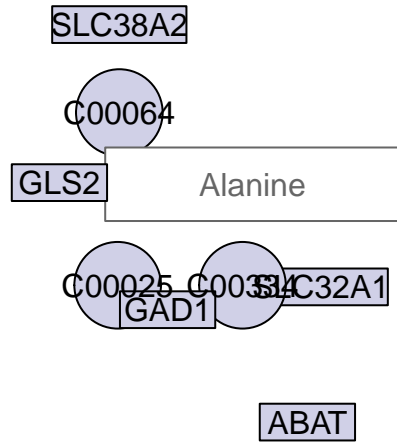

GABAergic synapse
MPI-005

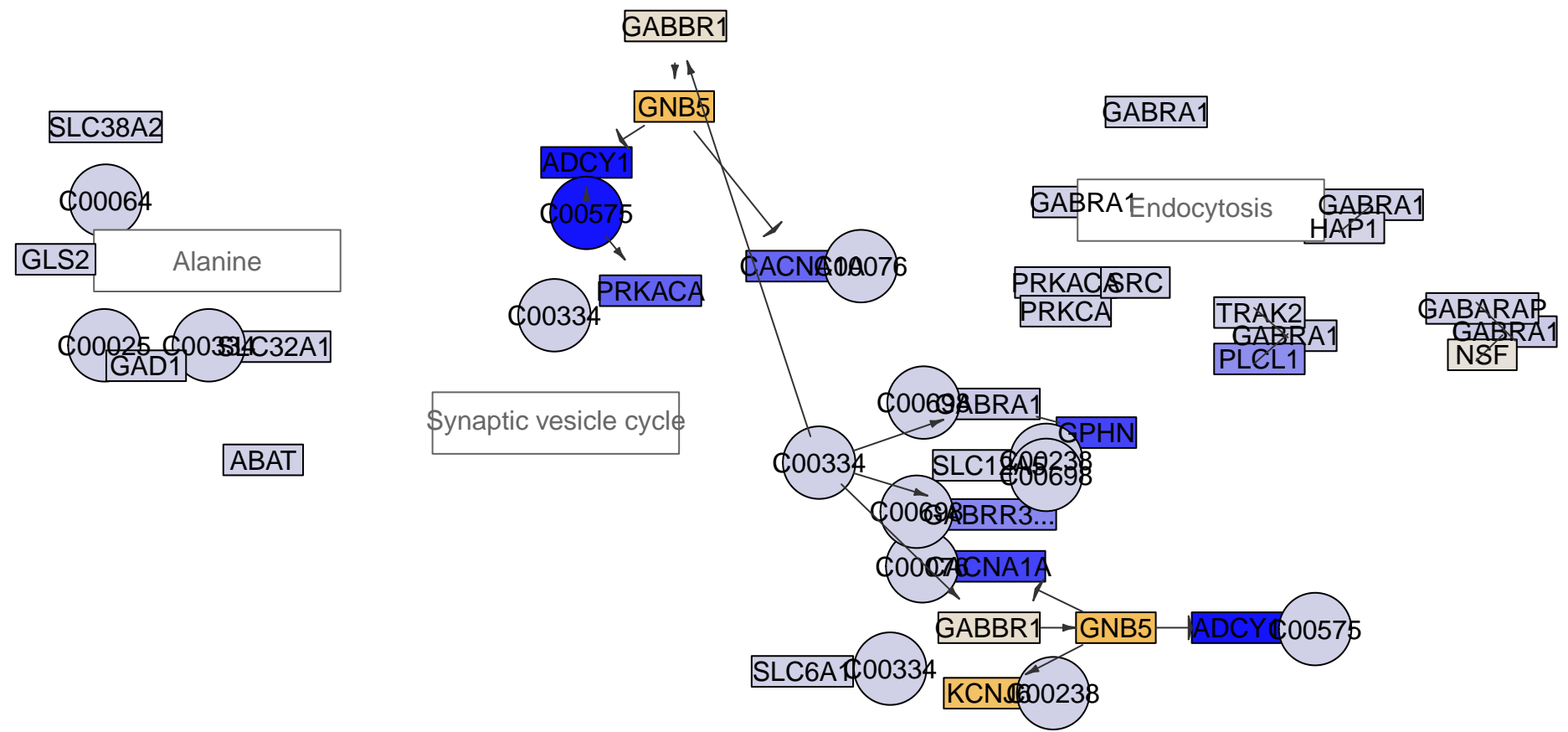

GABAergic synapse
MPI-006

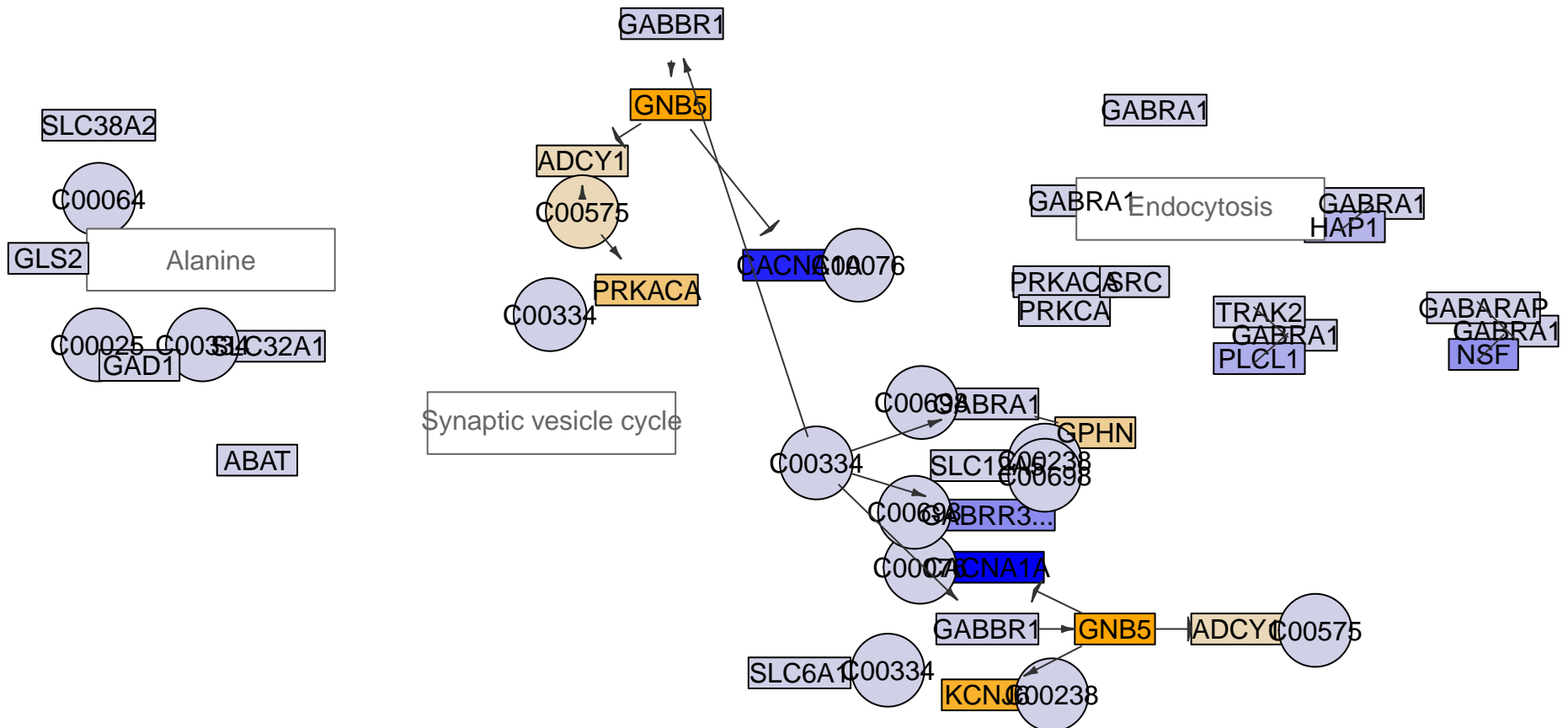
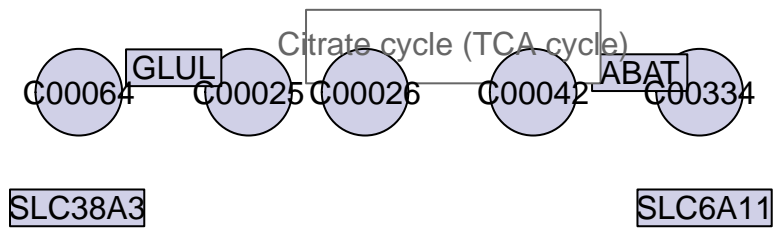

GABAergic synapse
MPI-016

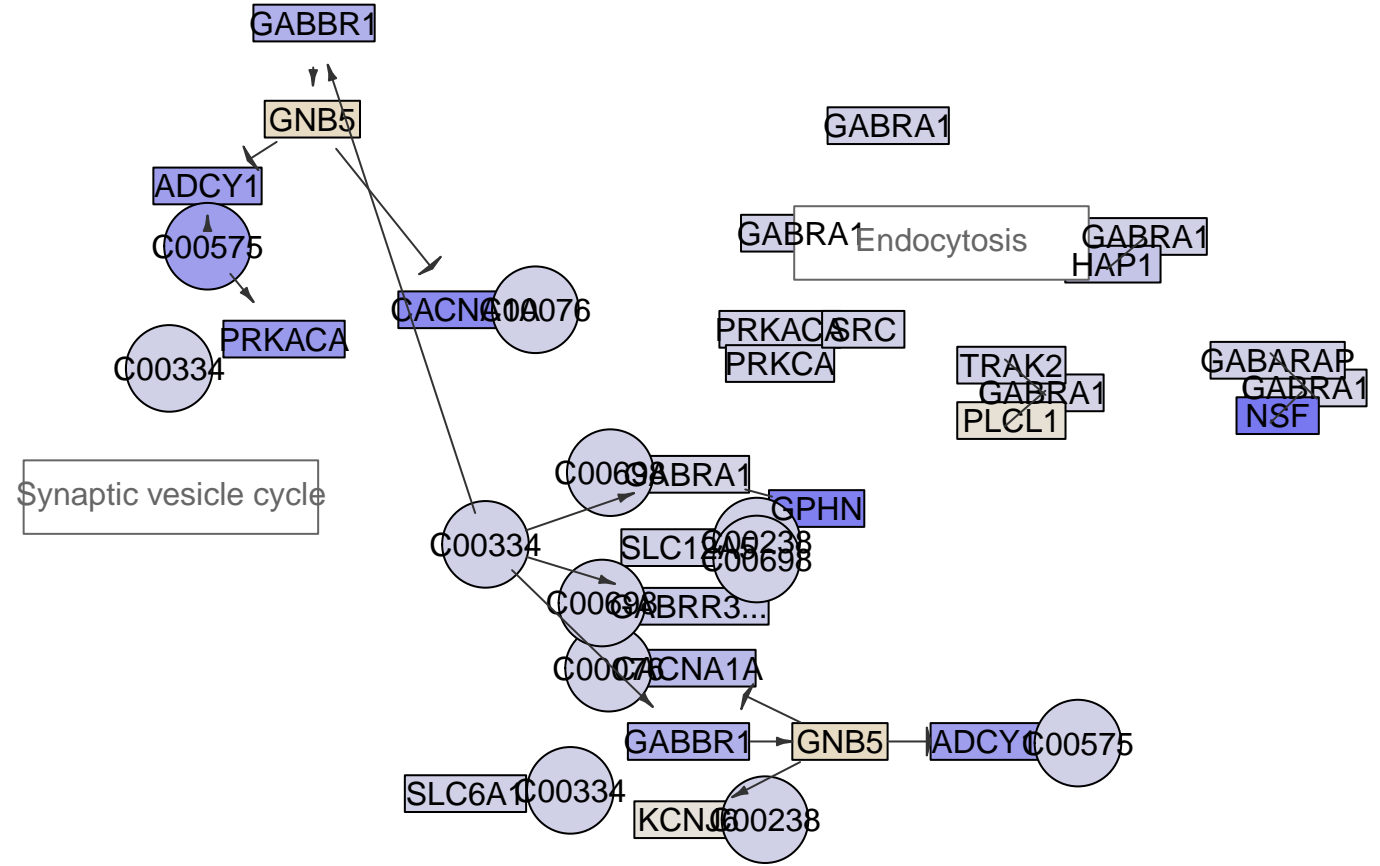
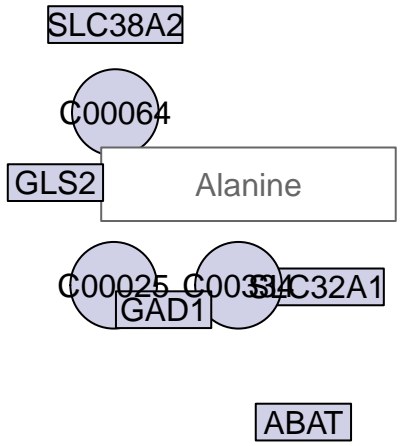

GABAergic synapse
MPI-017

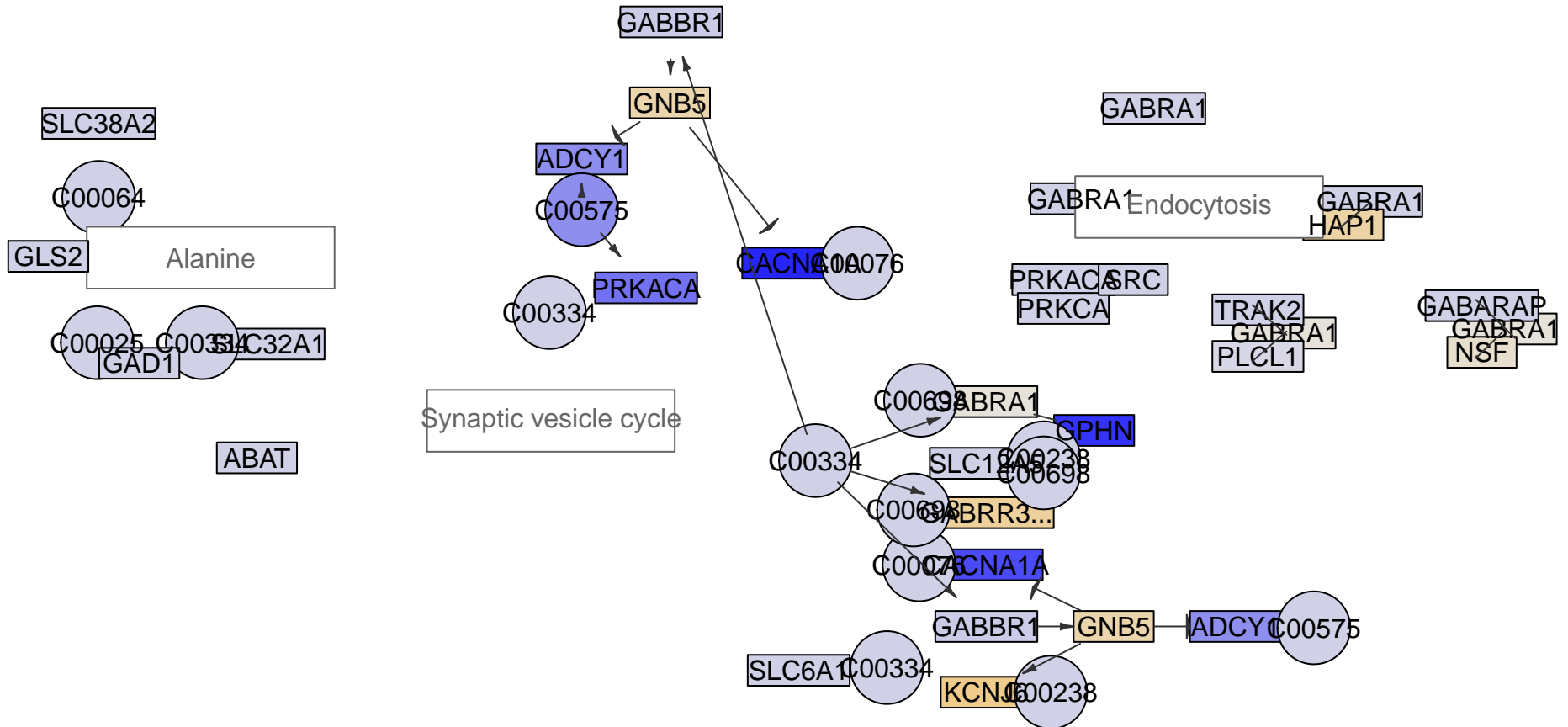
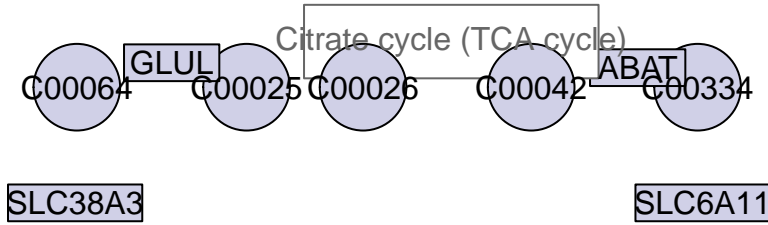

GABAergic synapse
MPI-018

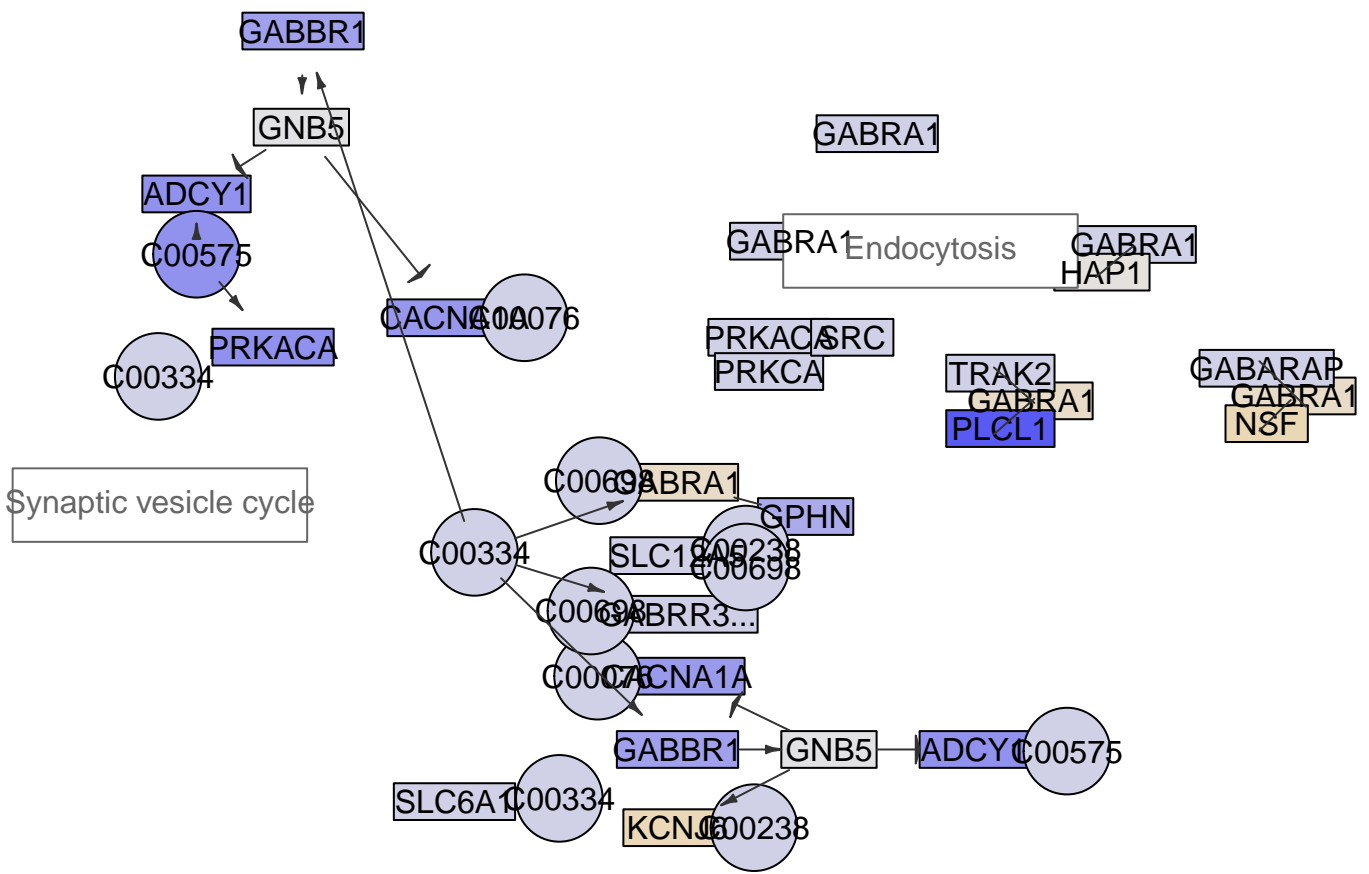
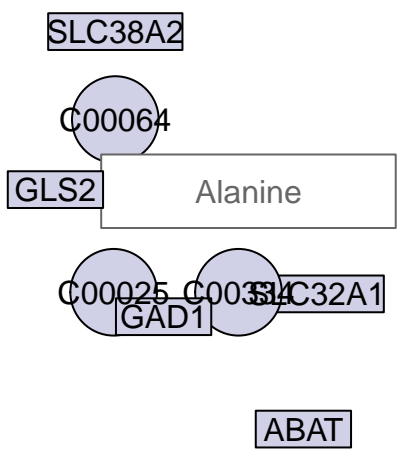

GABAergic synapse
MPI-027

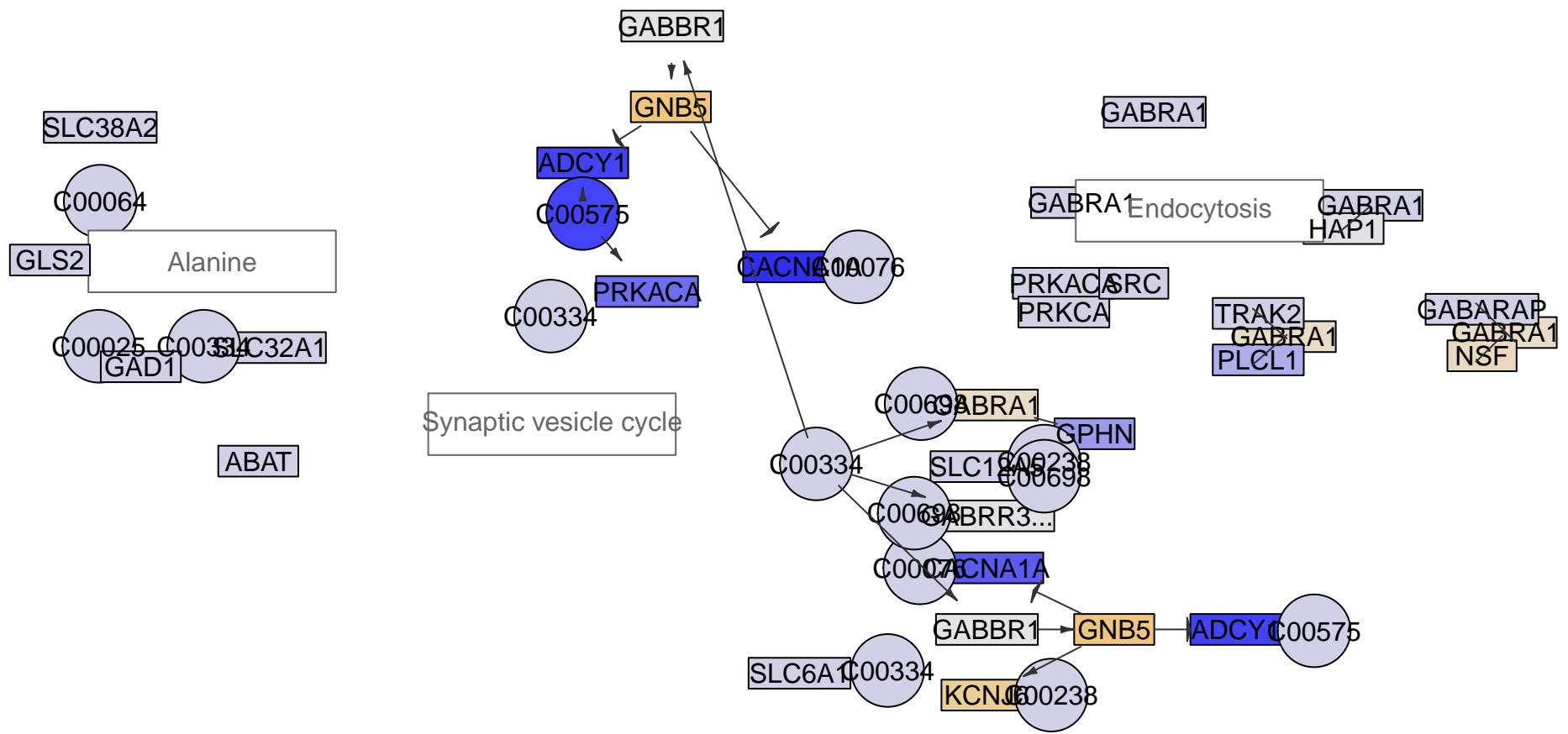

GABAergic synapse
MPI-028

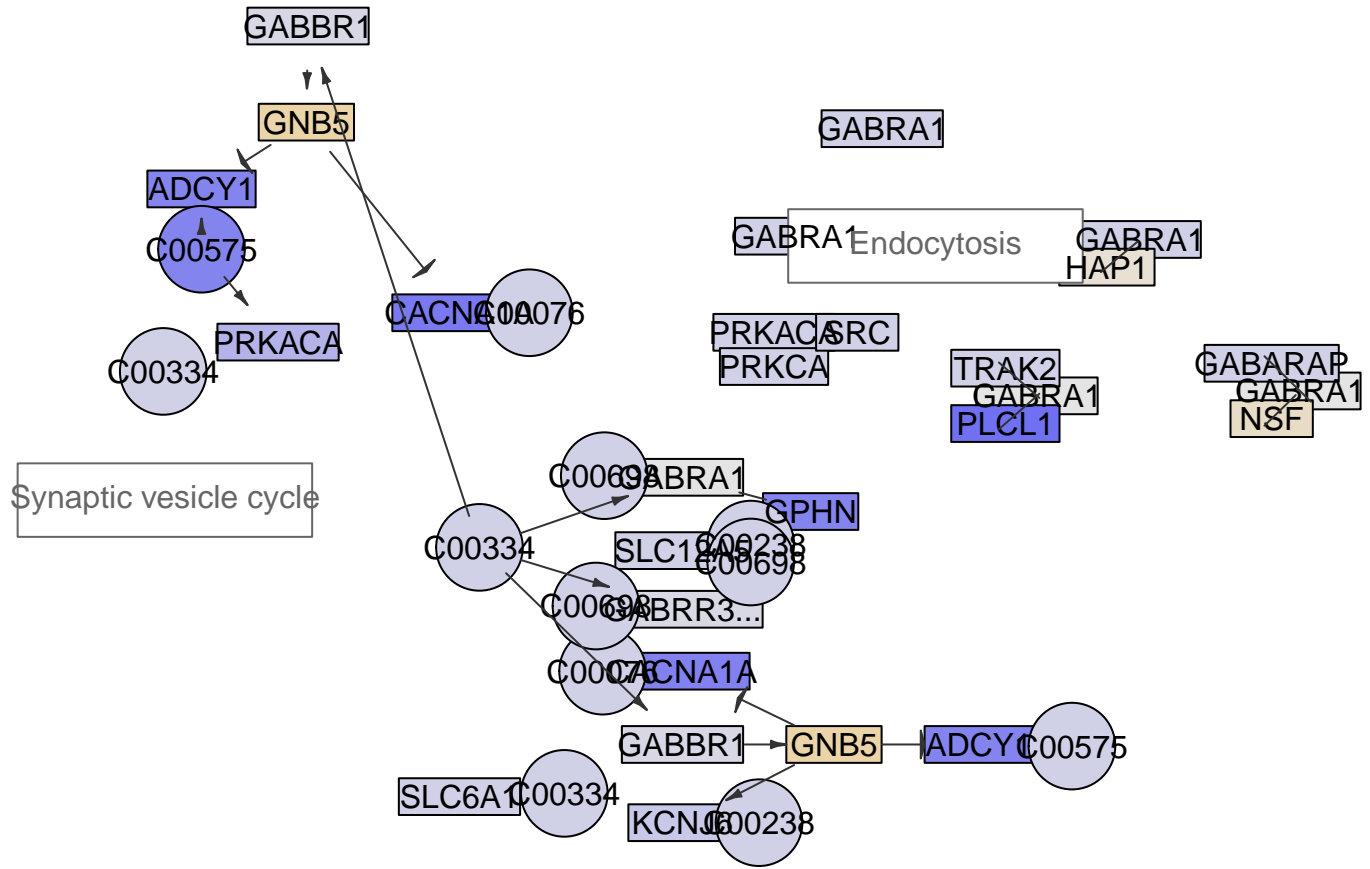
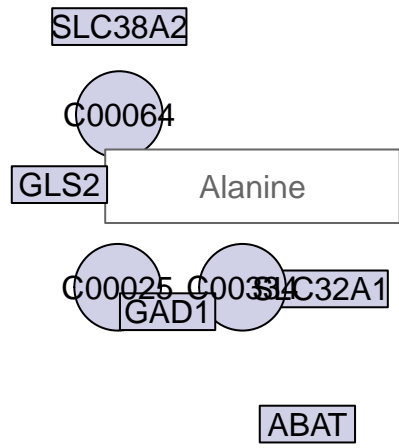

GABAergic synapse
MPI-032

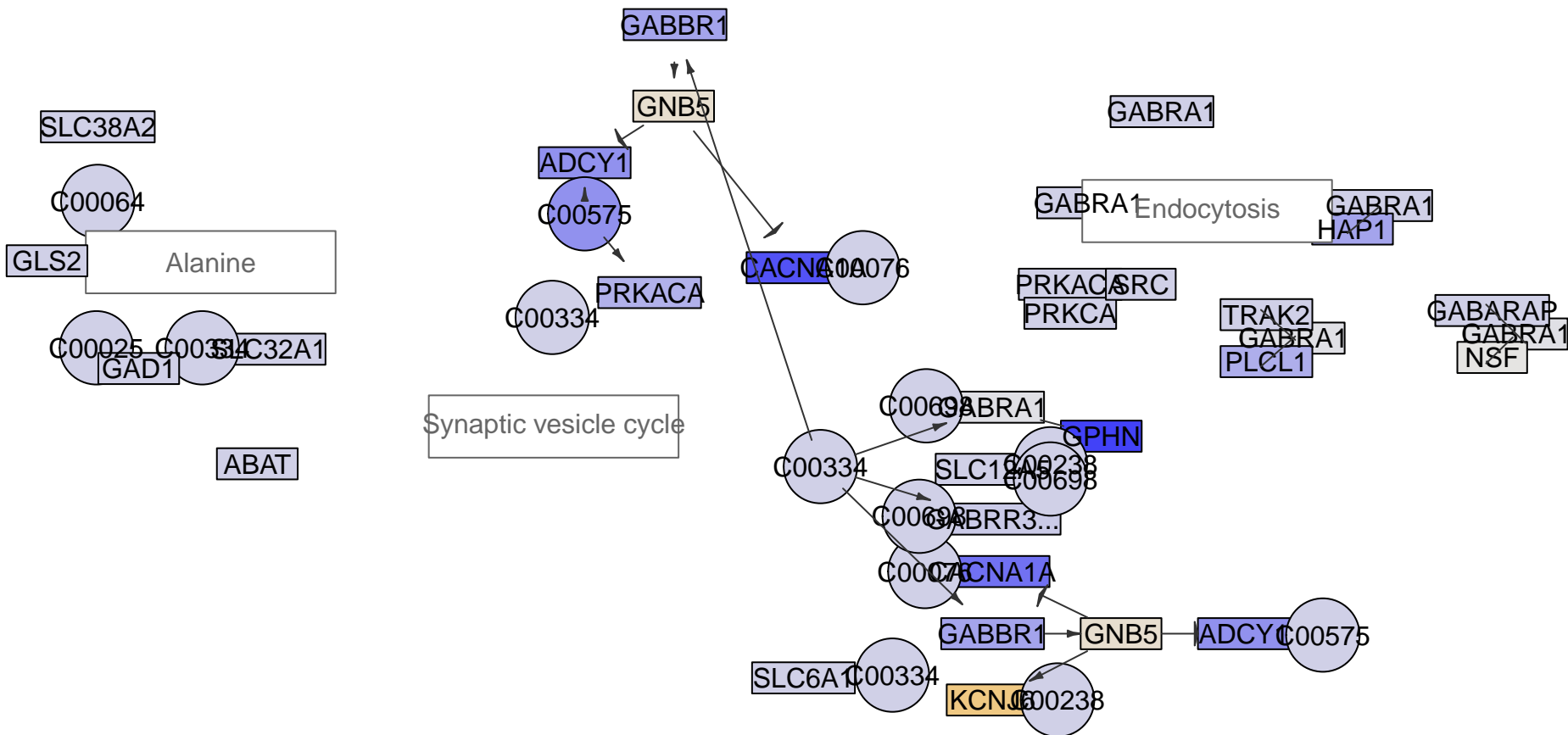
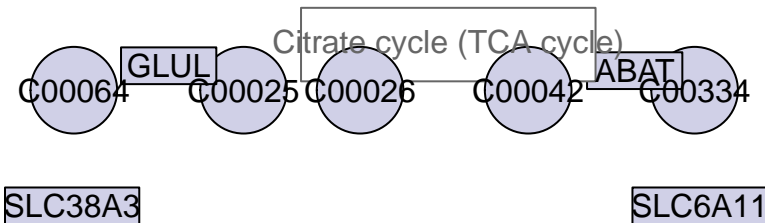

GABAergic synapse
MPI-033

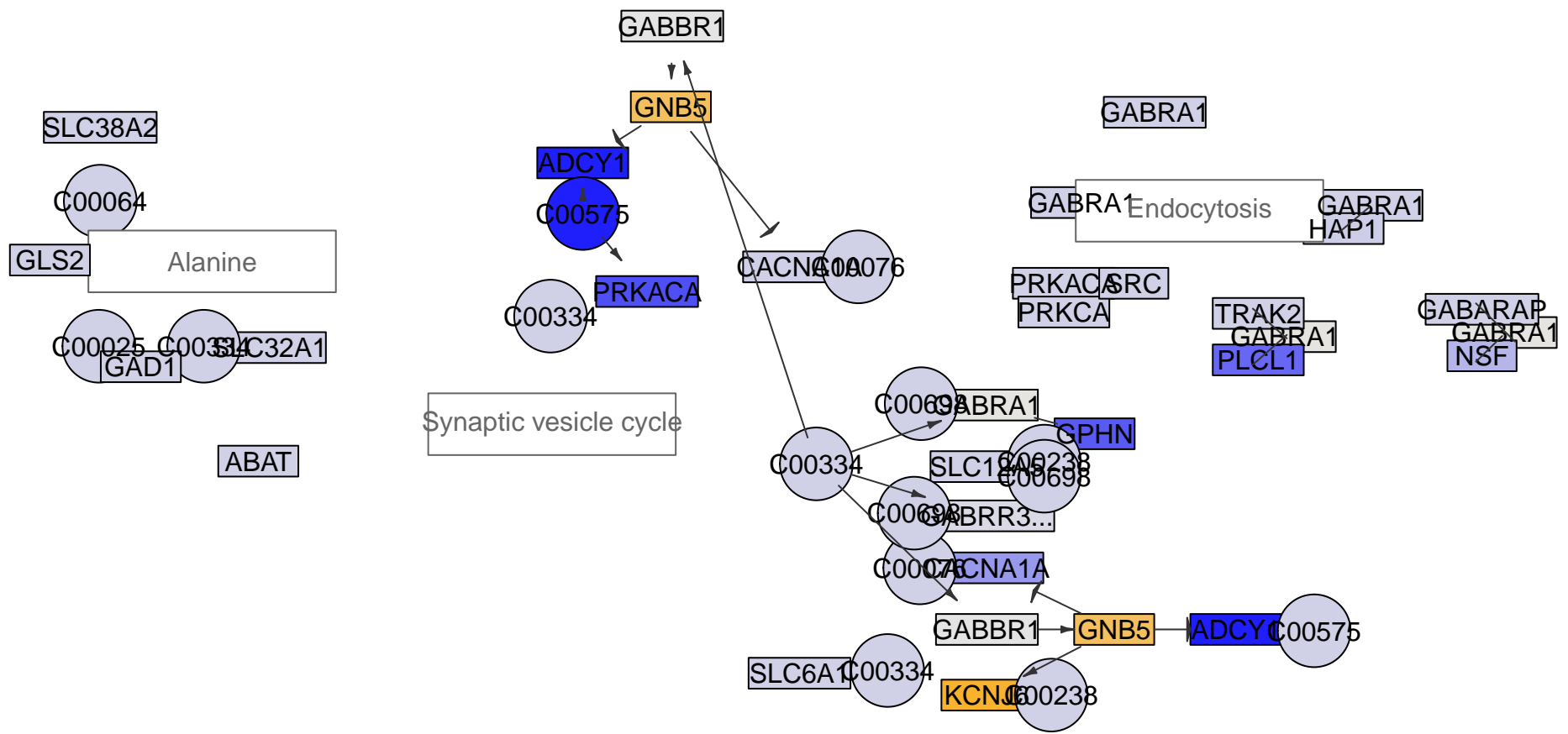

GABAergic synapse
MPI-034

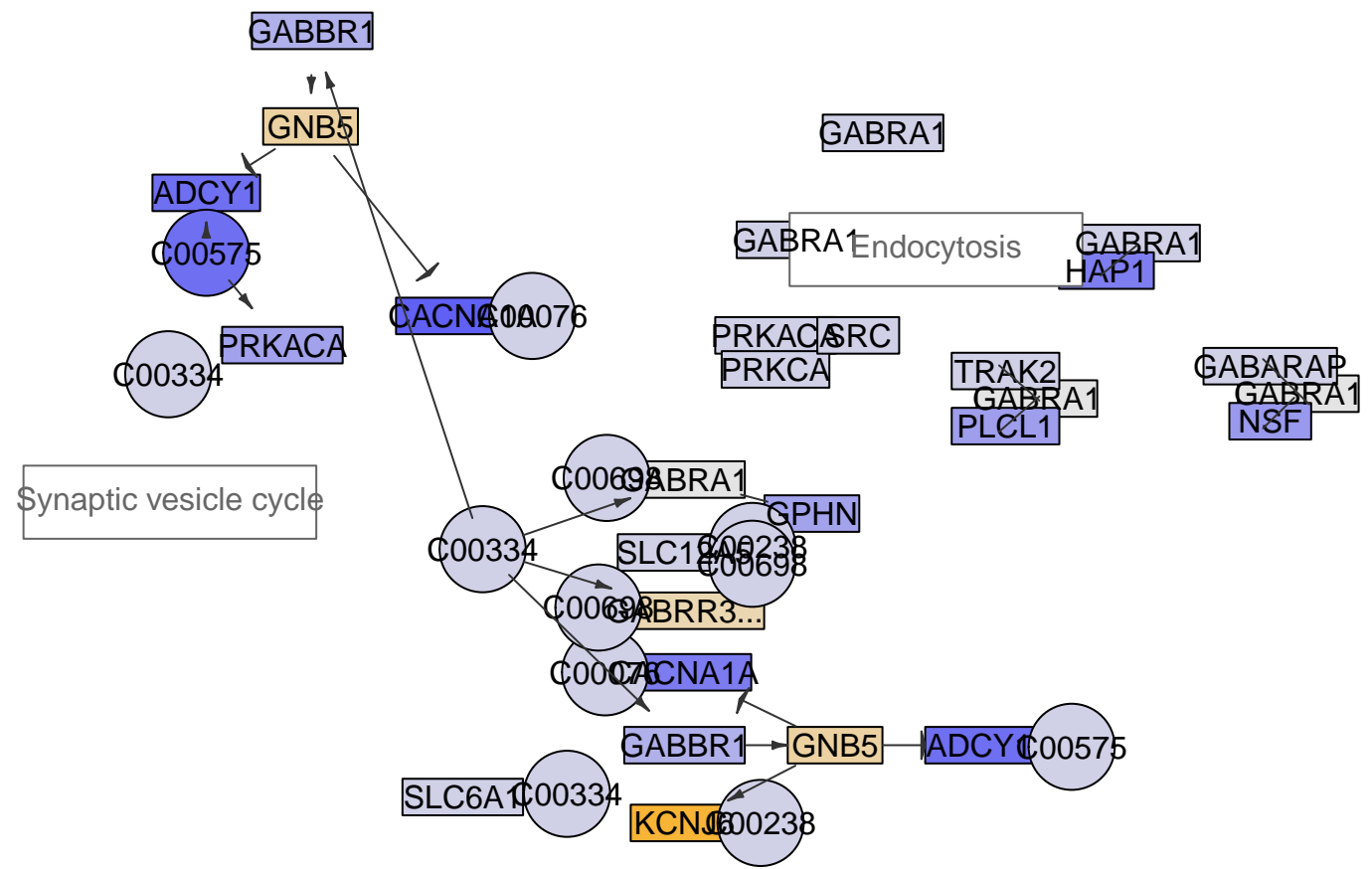
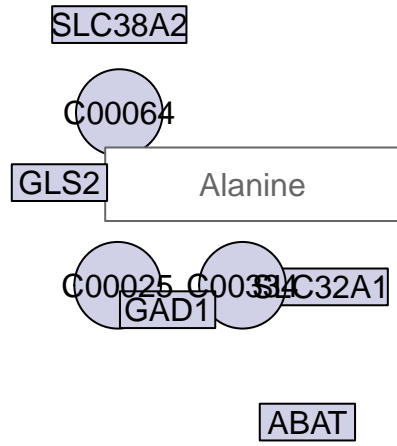

GABAergic synapse
MPI-043

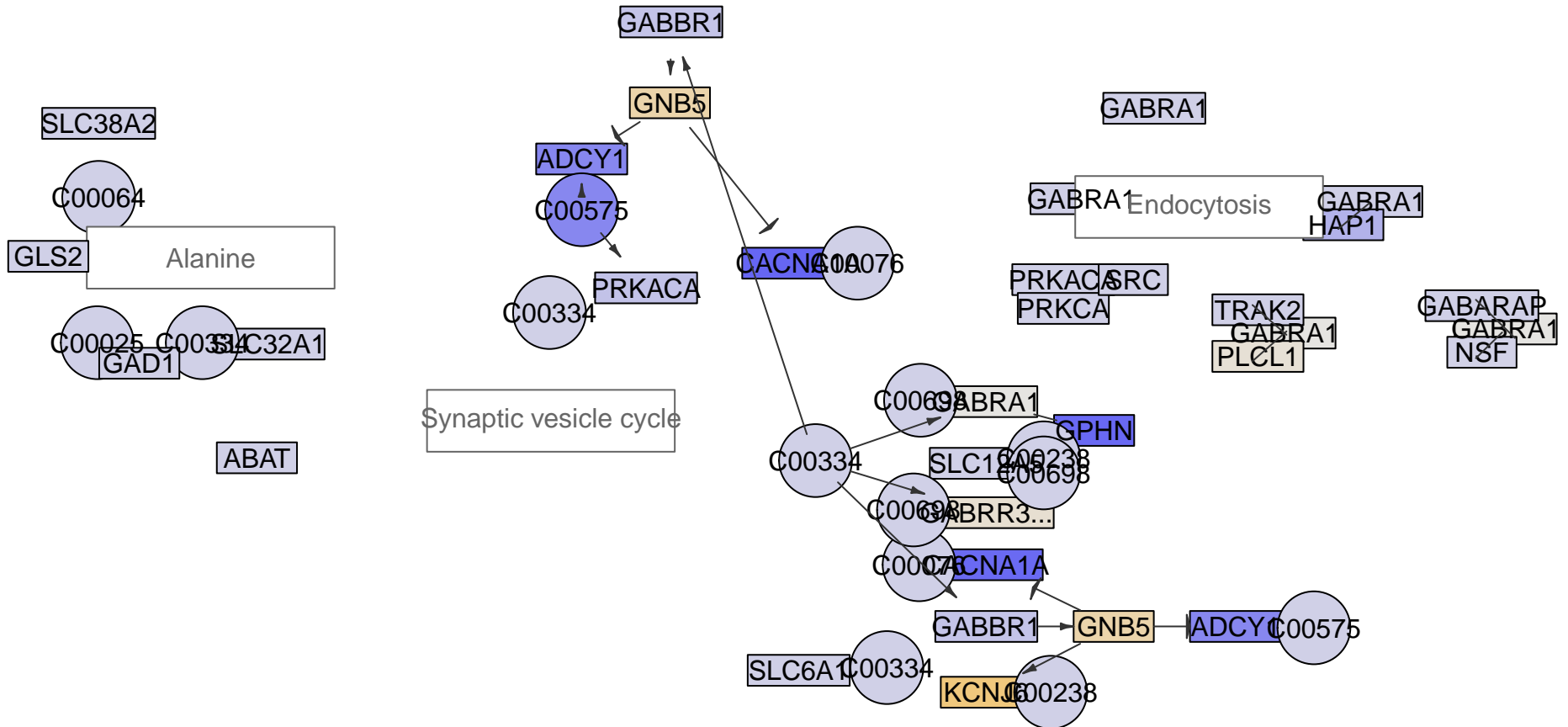
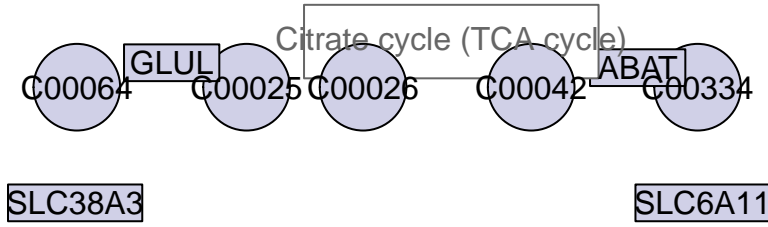

GABAergic synapse
MPI-044

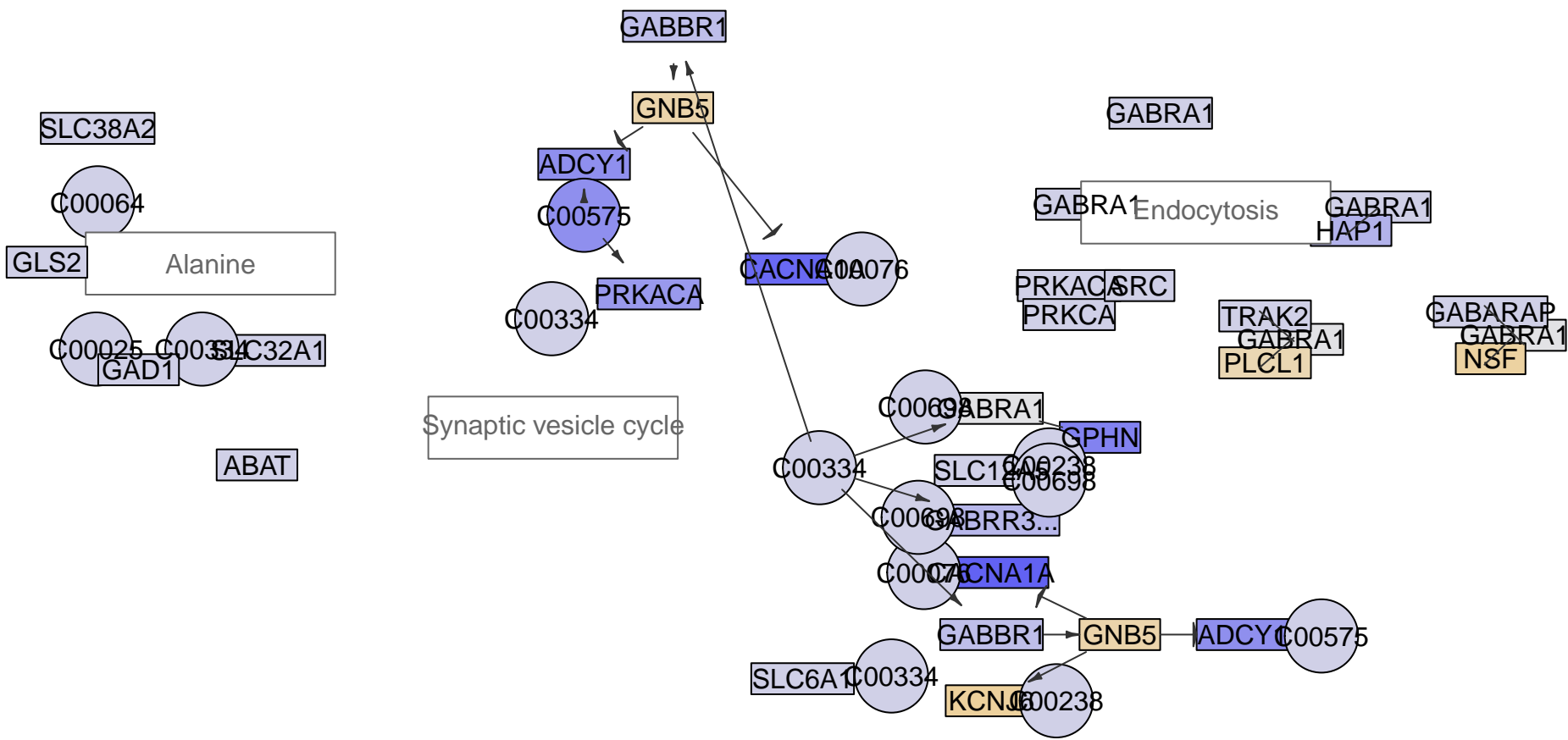

GABAergic synapse
MPI-048

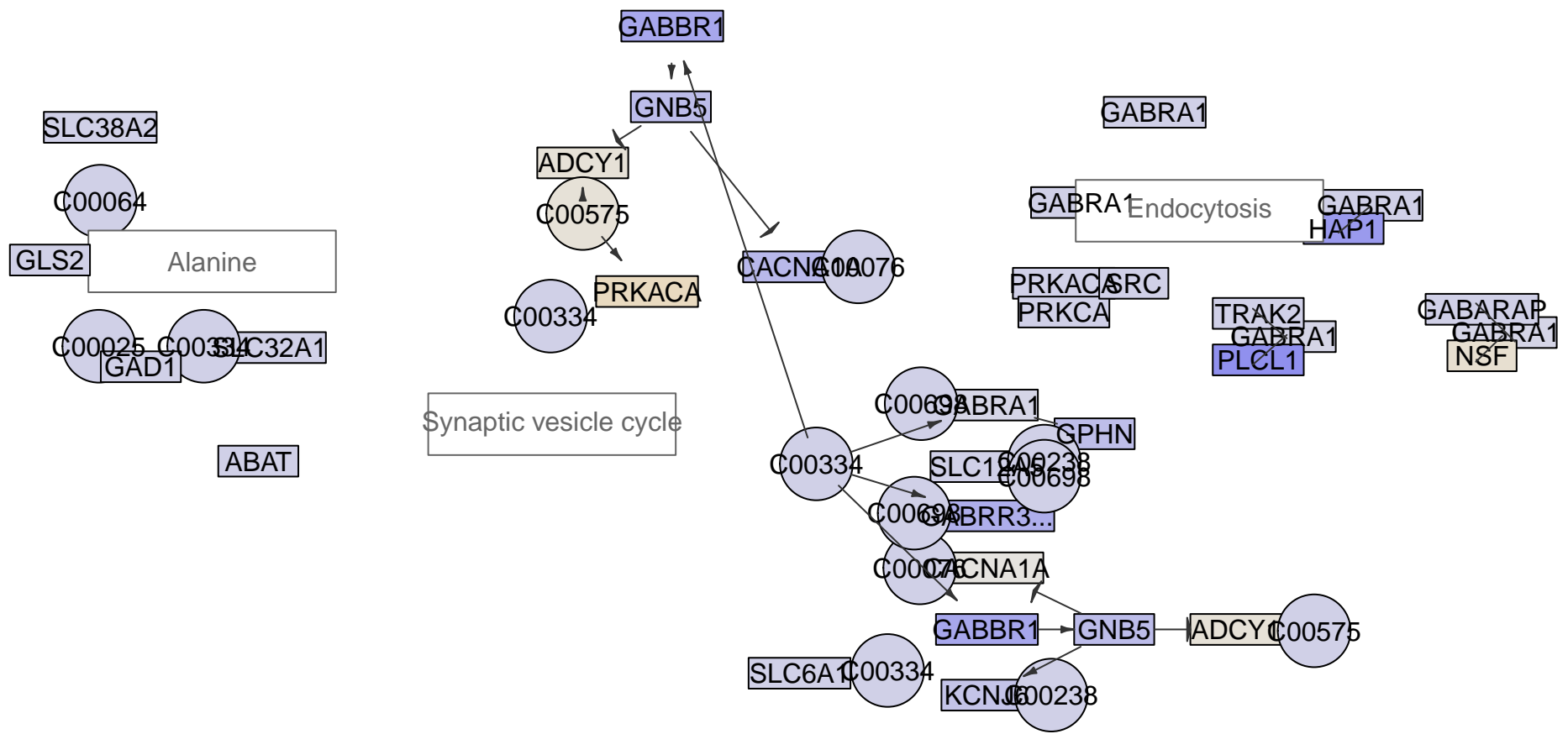

GABAergic synapse
MPI-055

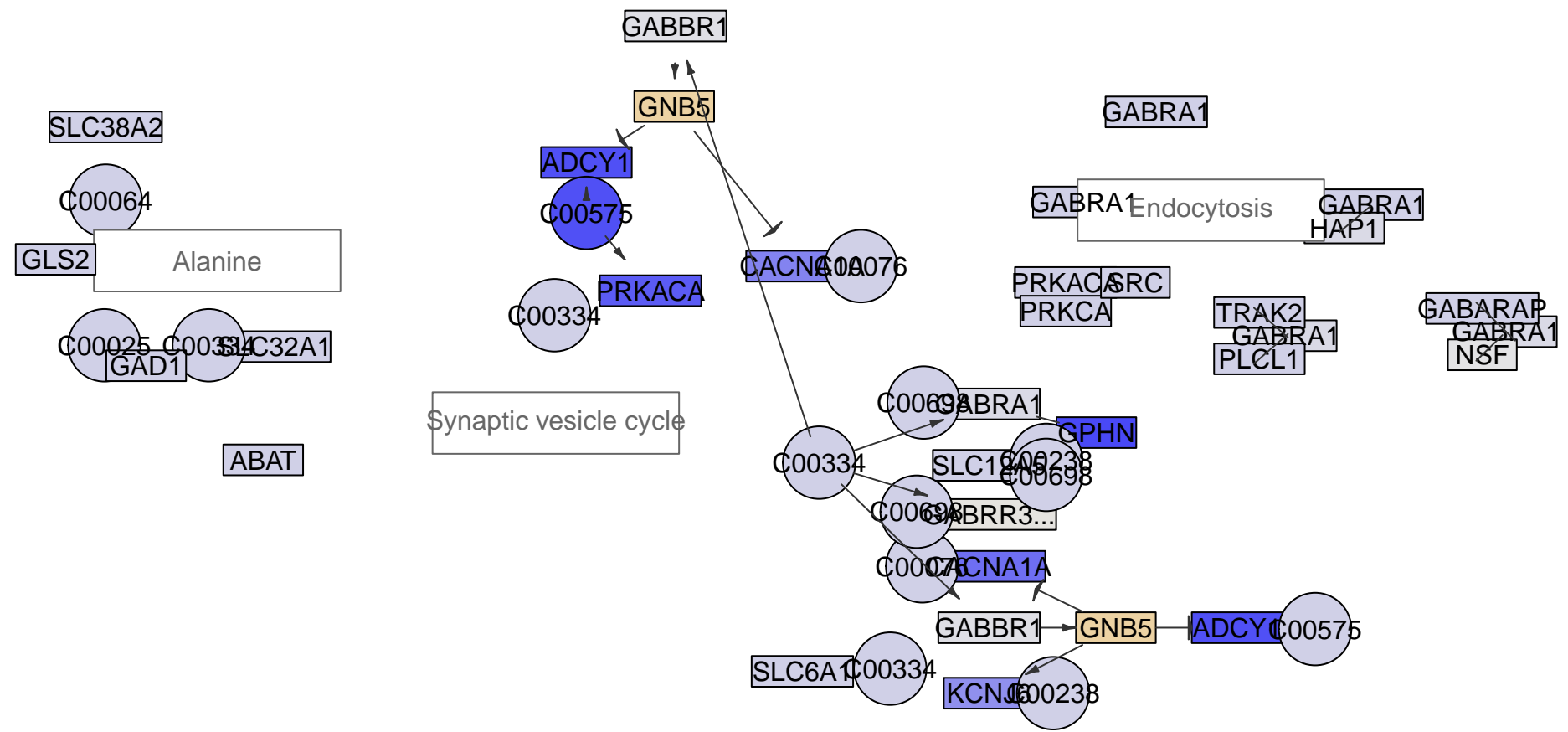

GABAergic synapse
MPI-065

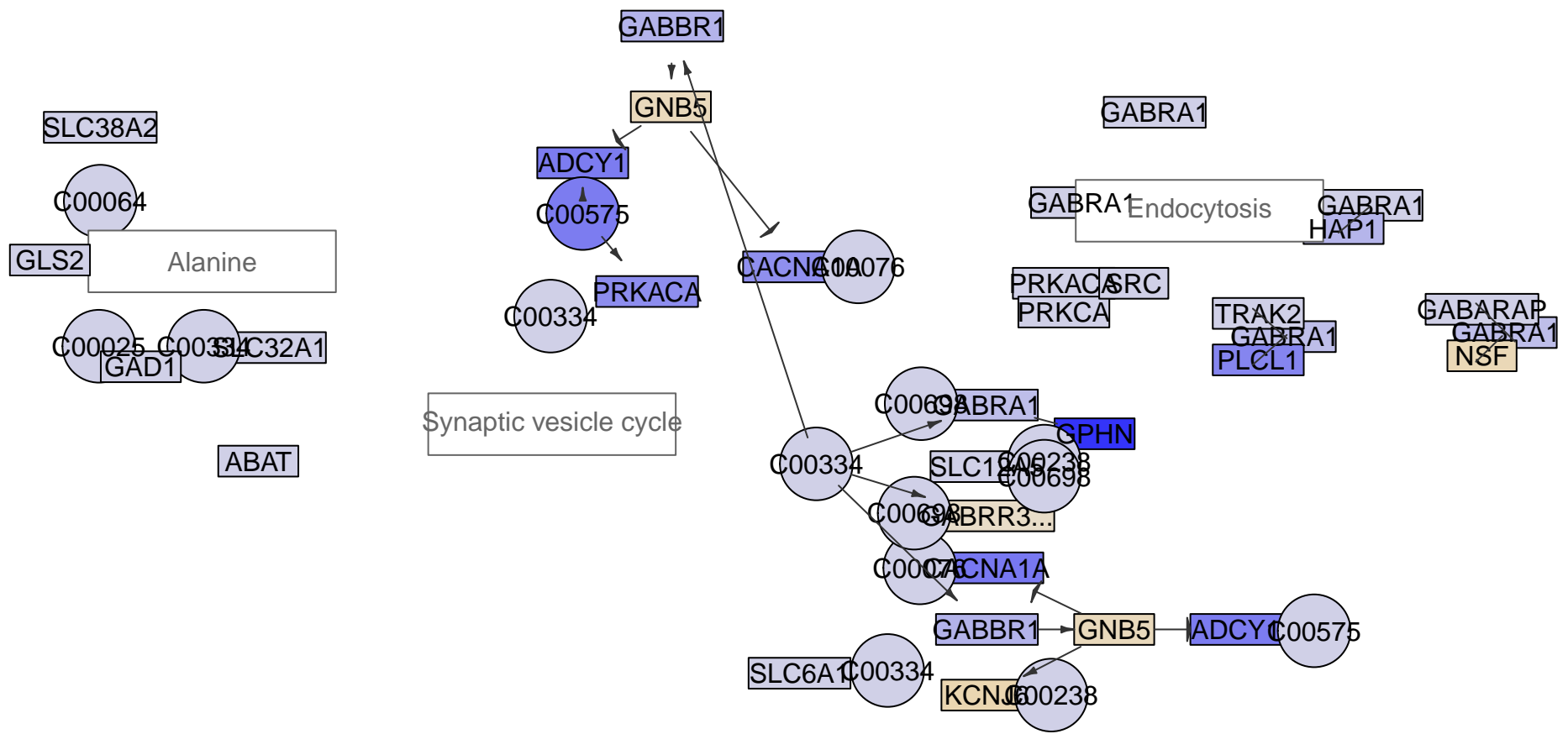

GABAergic synapse
MPI-071

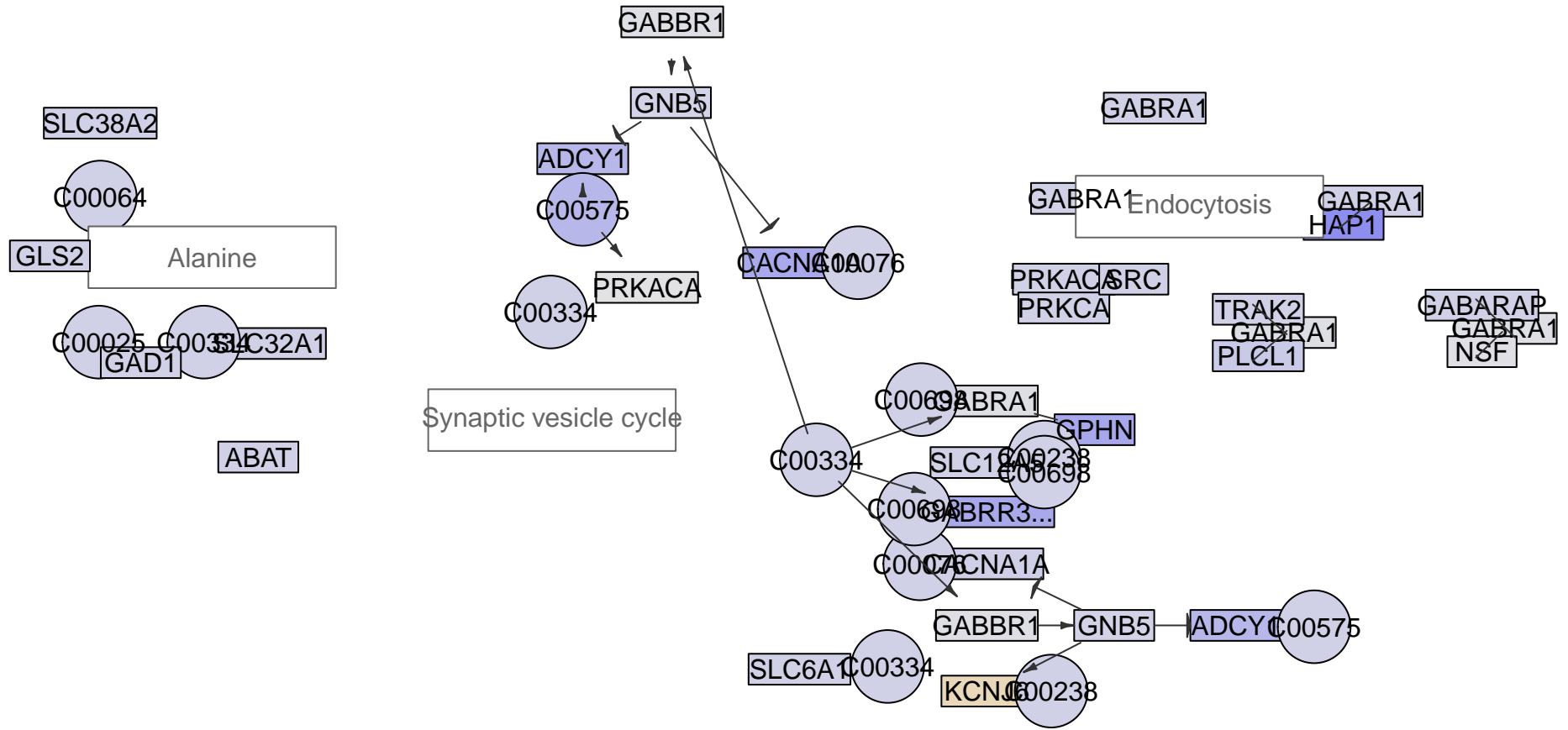

GABAergic synapse
MPI-075

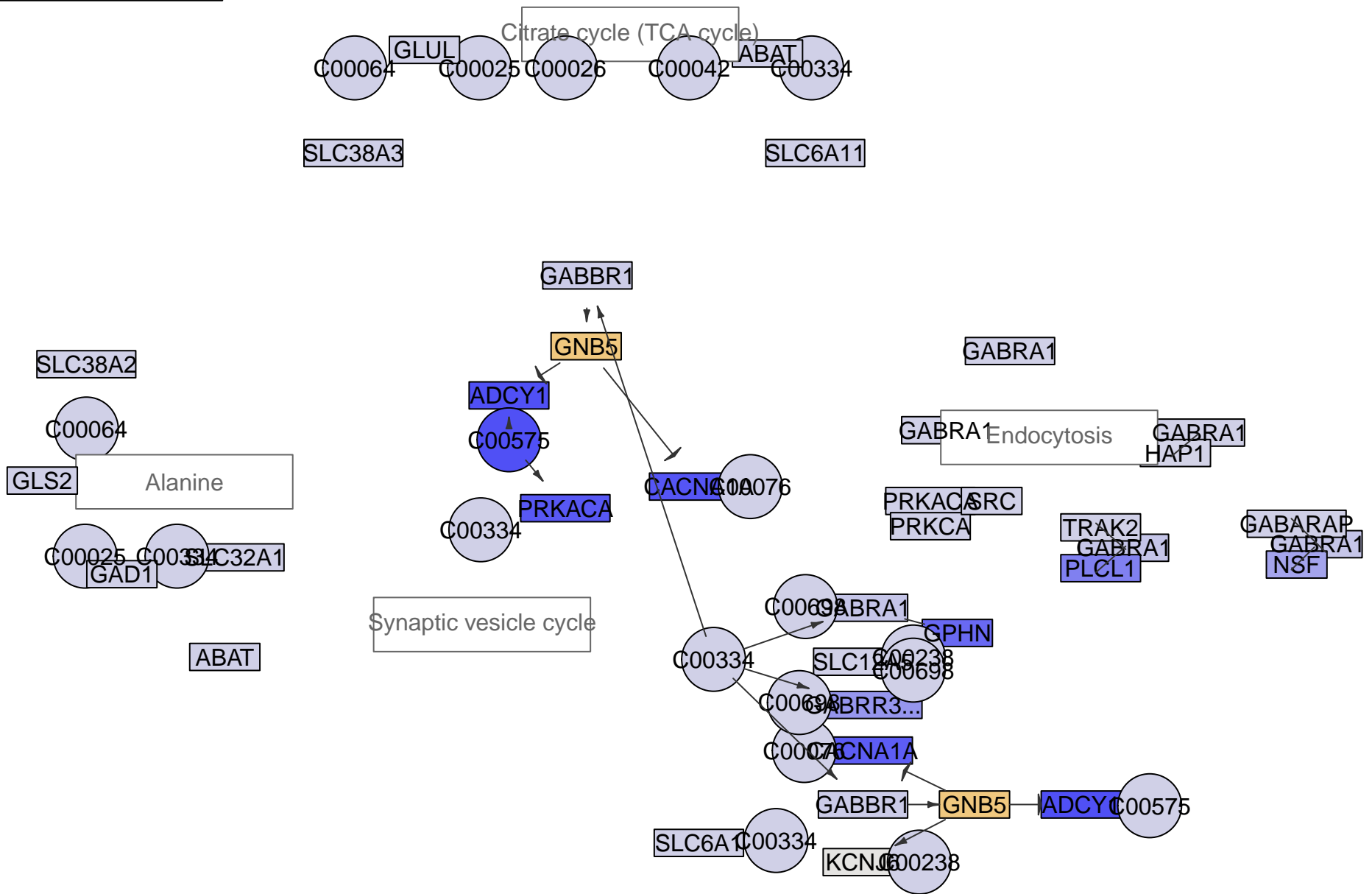

GABAergic synapse
MPI-077

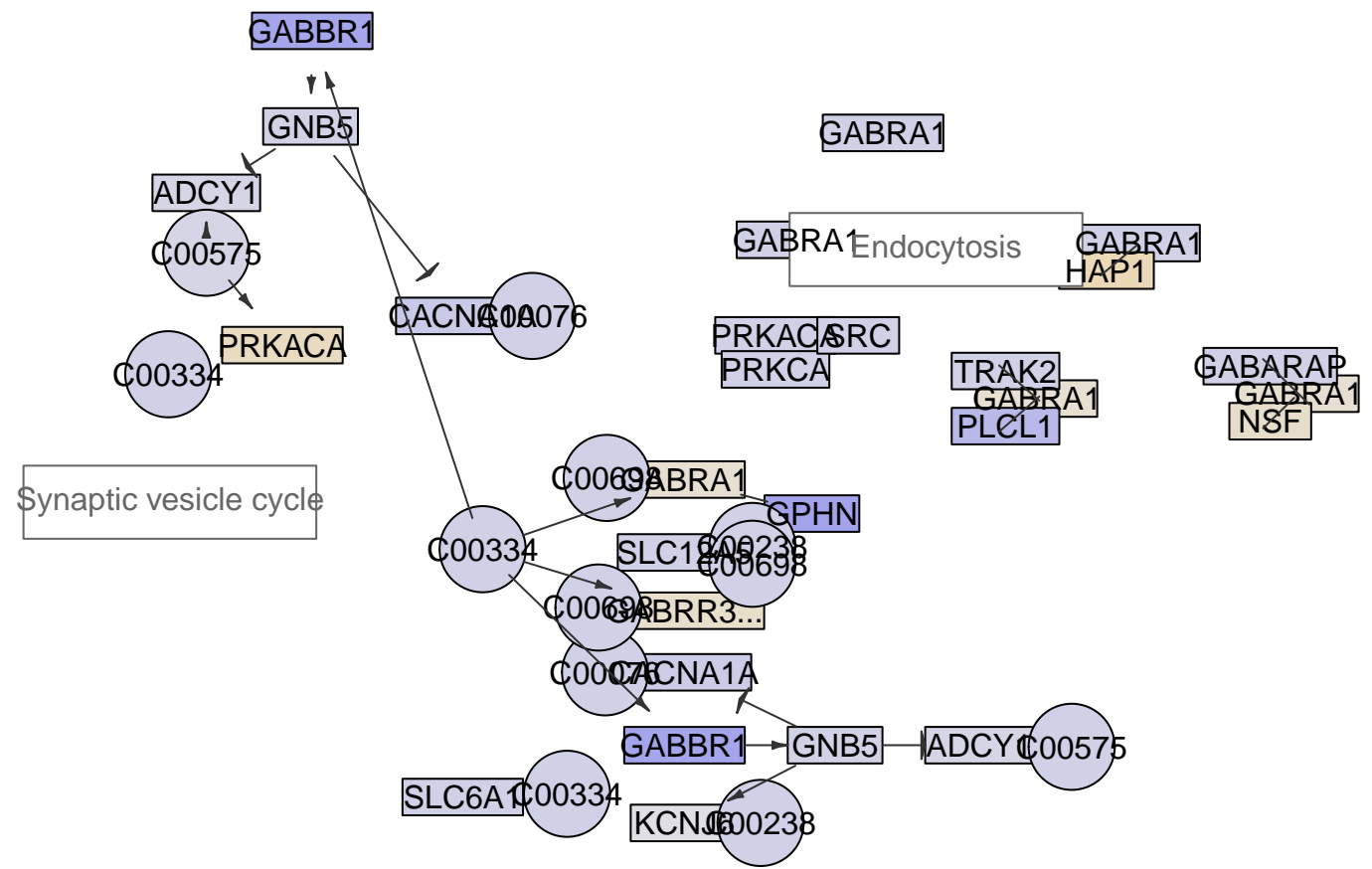
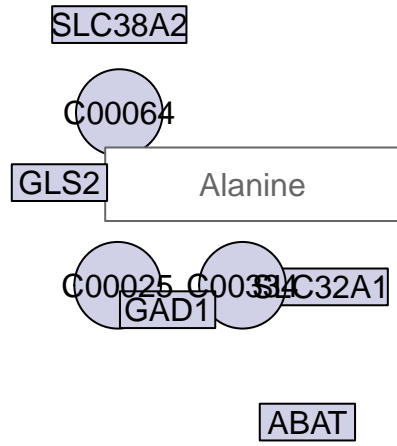

GABAergic synapse
MPI-078

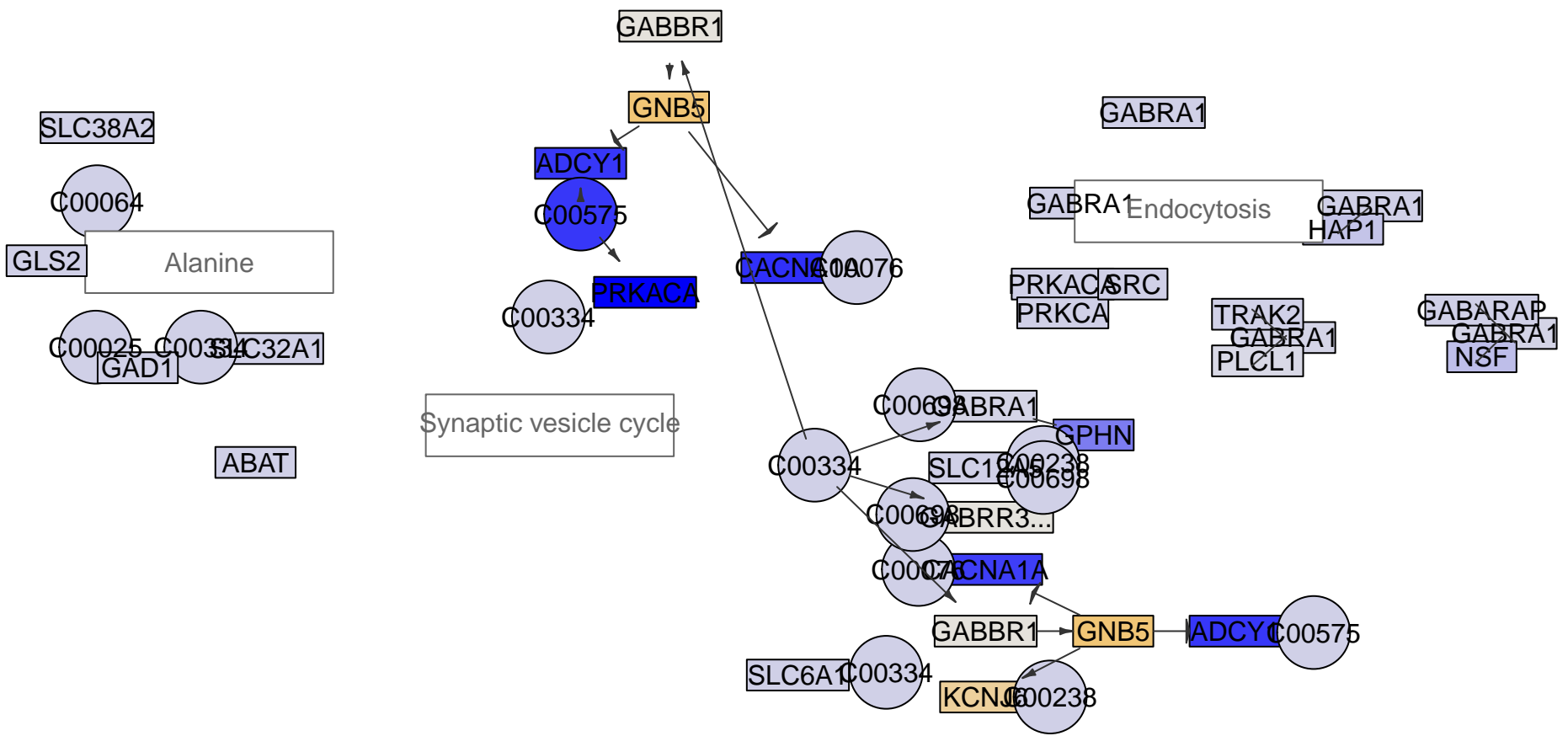

GABAergic synapse
MPI-079

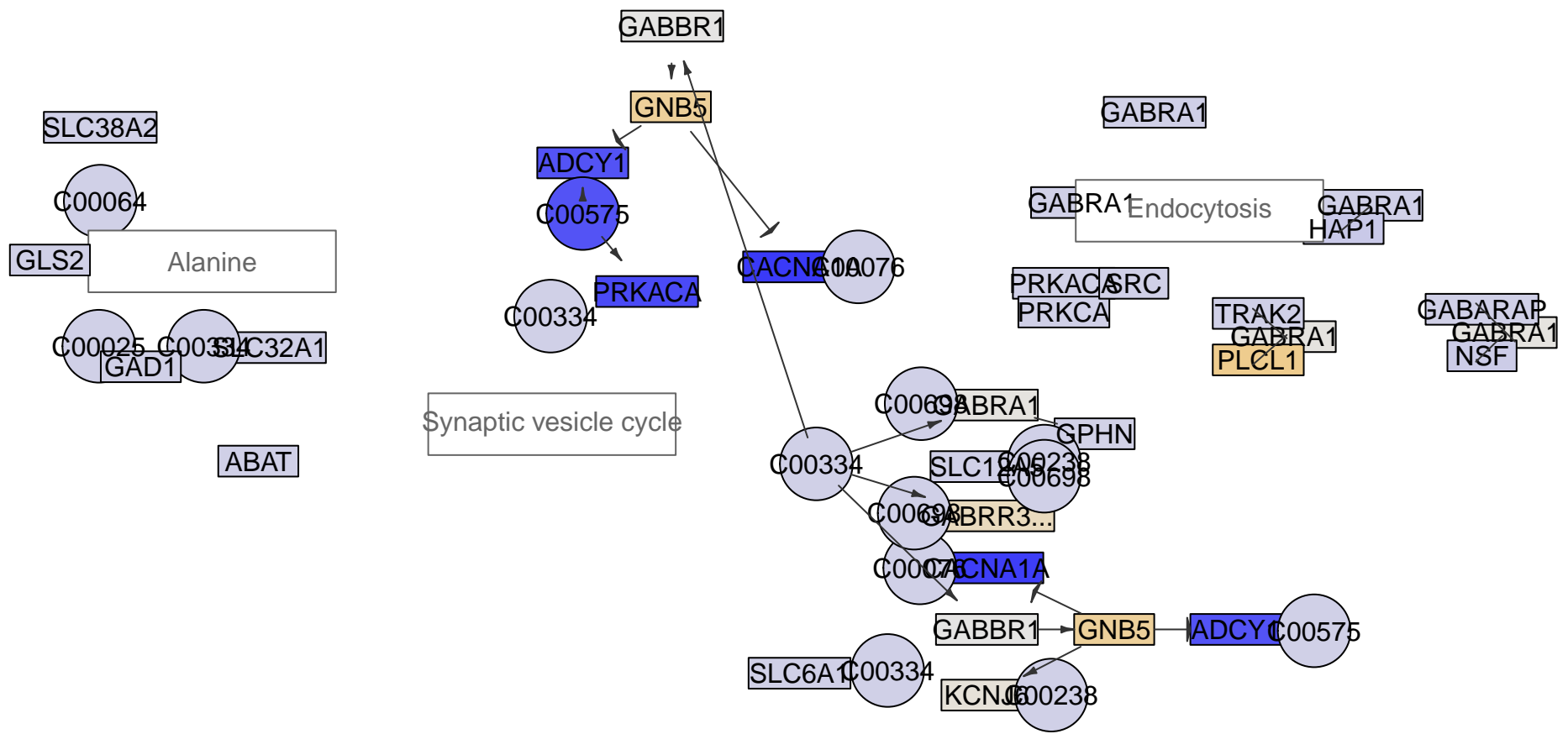

GABAergic synapse
MPI-080

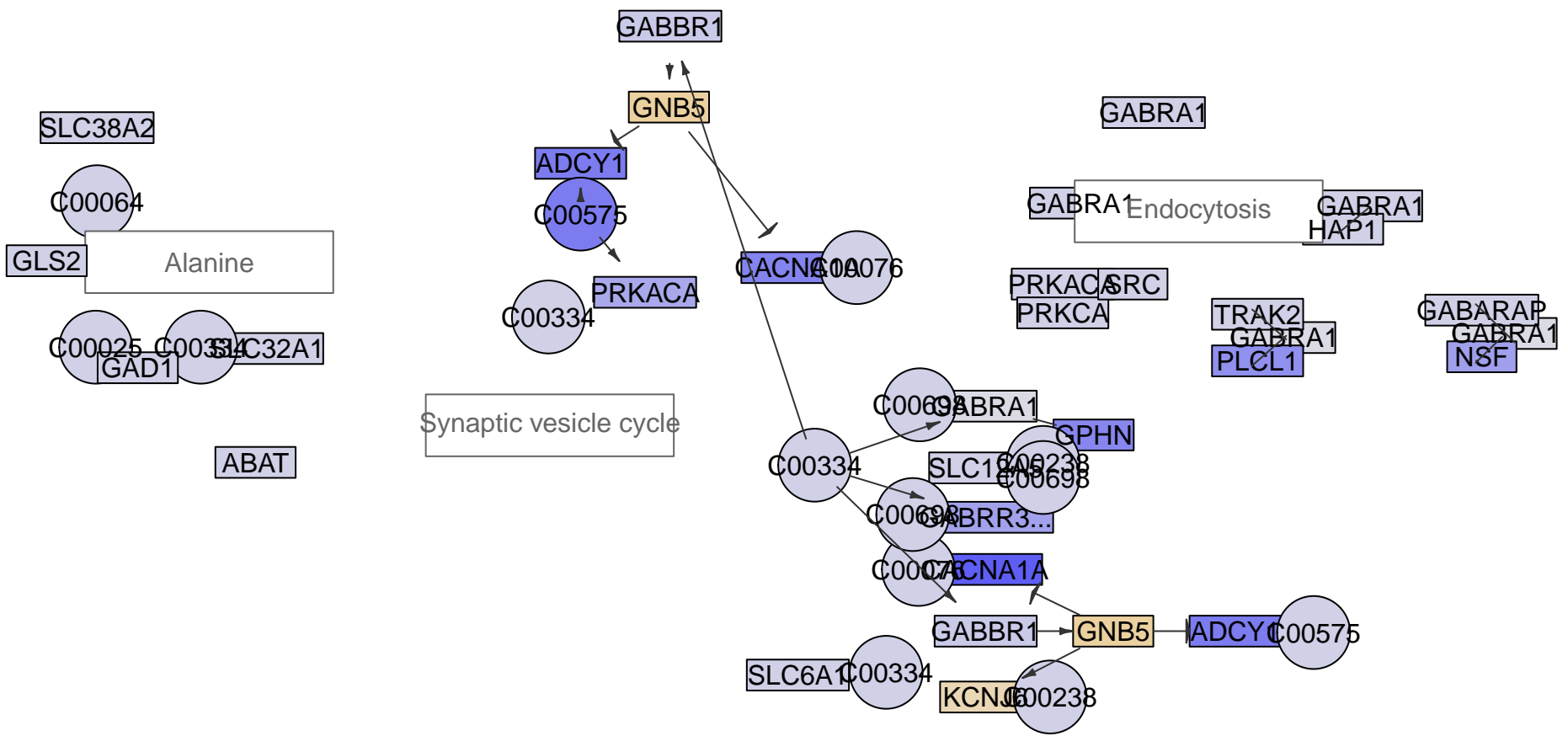

GABAergic synapse
MPI-081

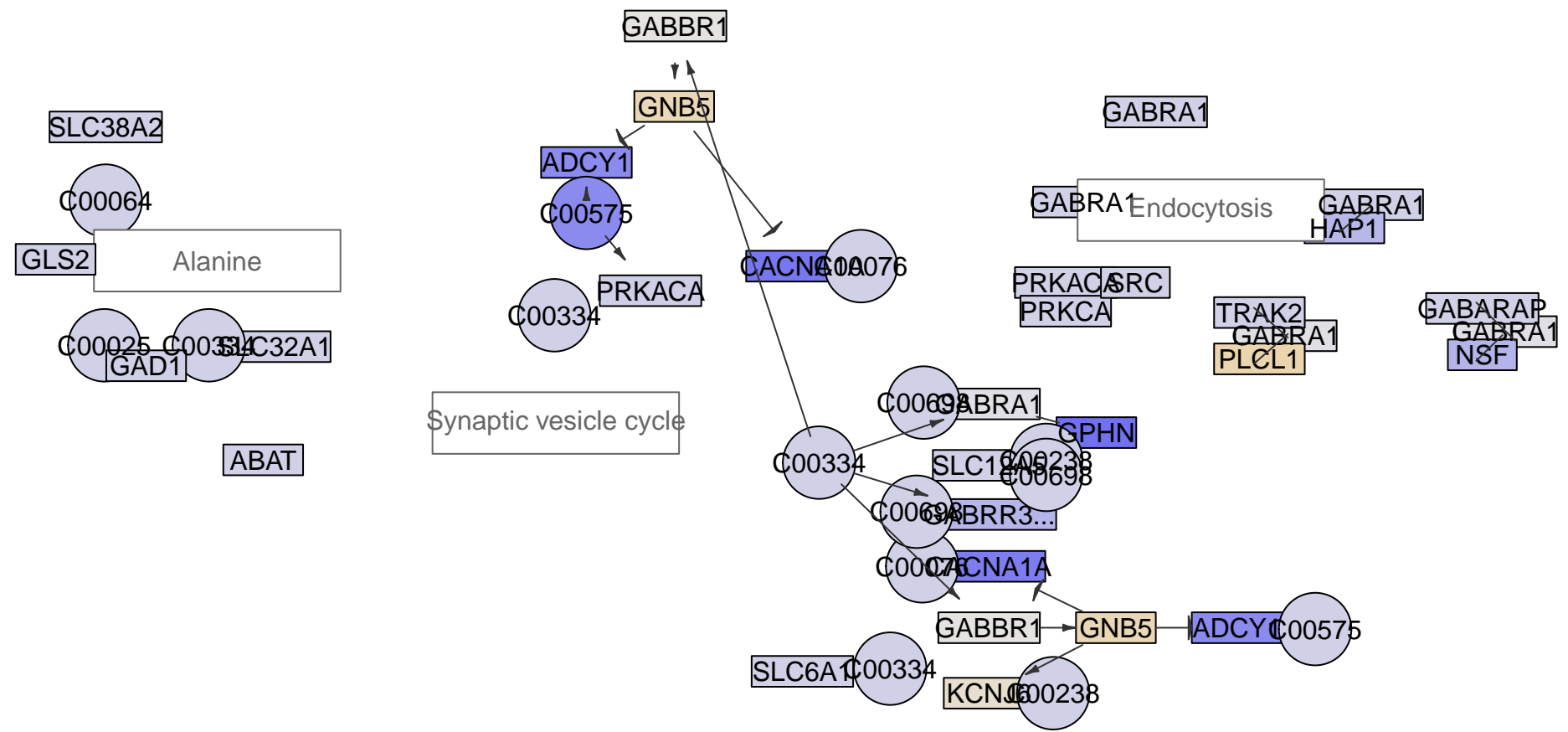

GABAergic synapse
MPI-082

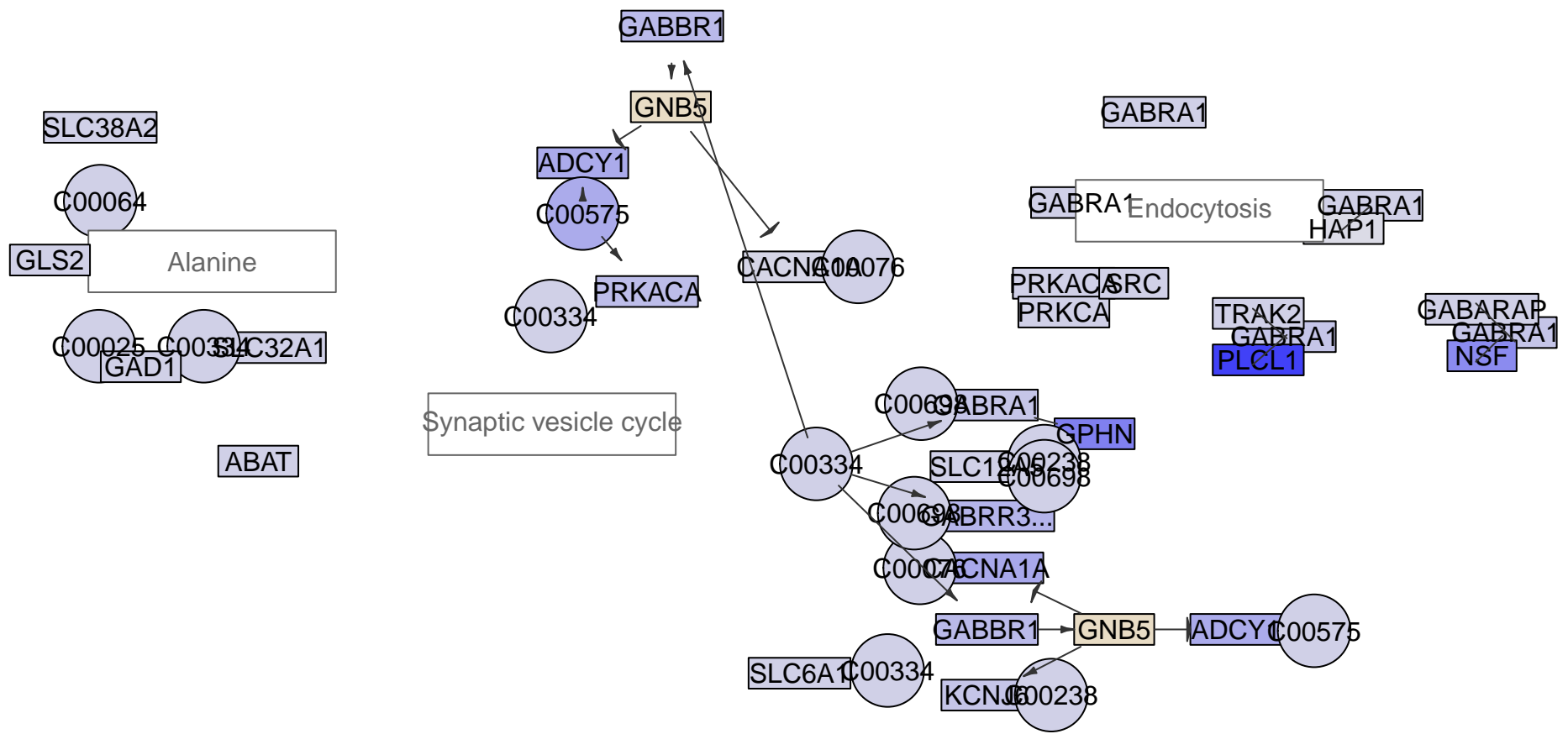

GABAergic synapse
MPI-084

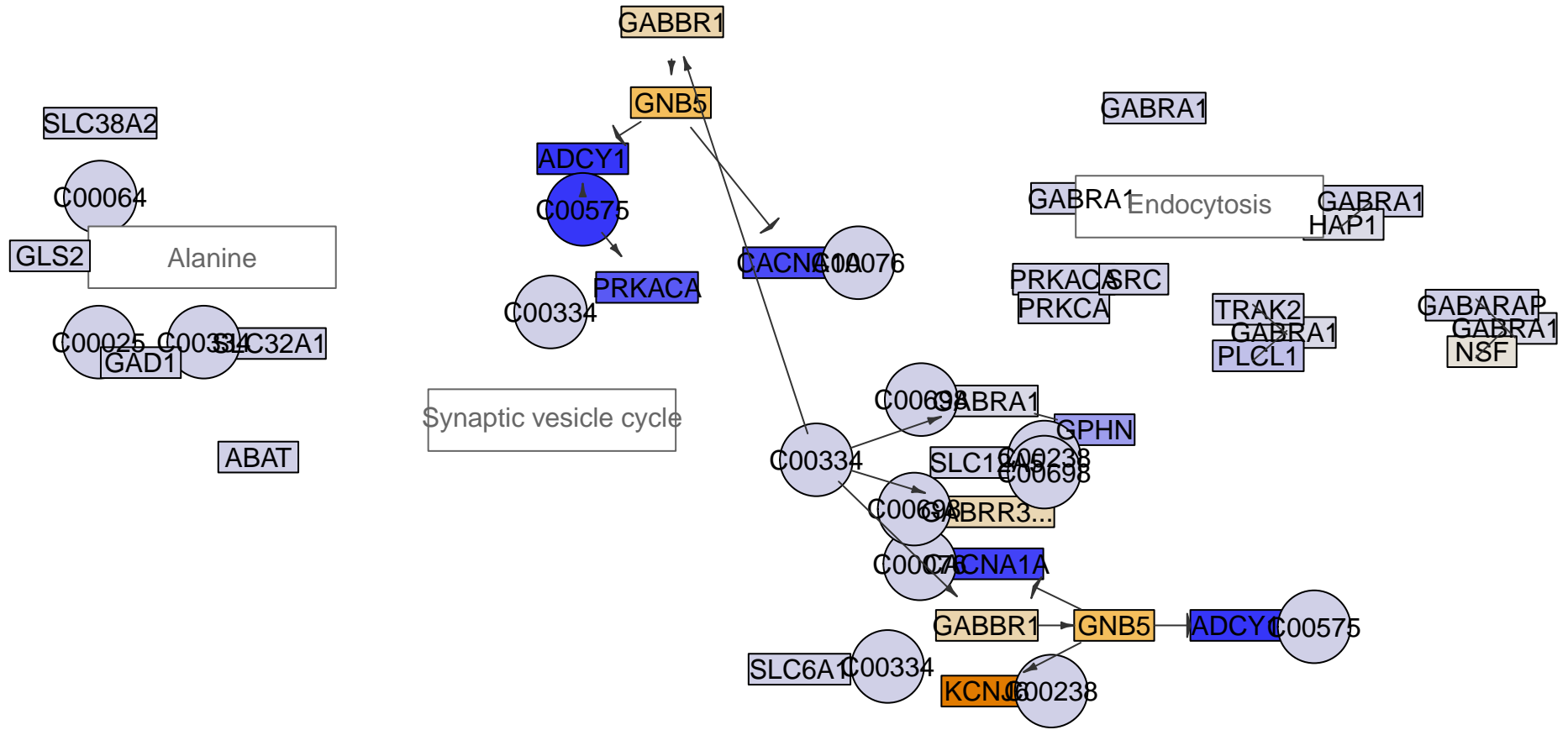

GABAergic synapse
MPI-085

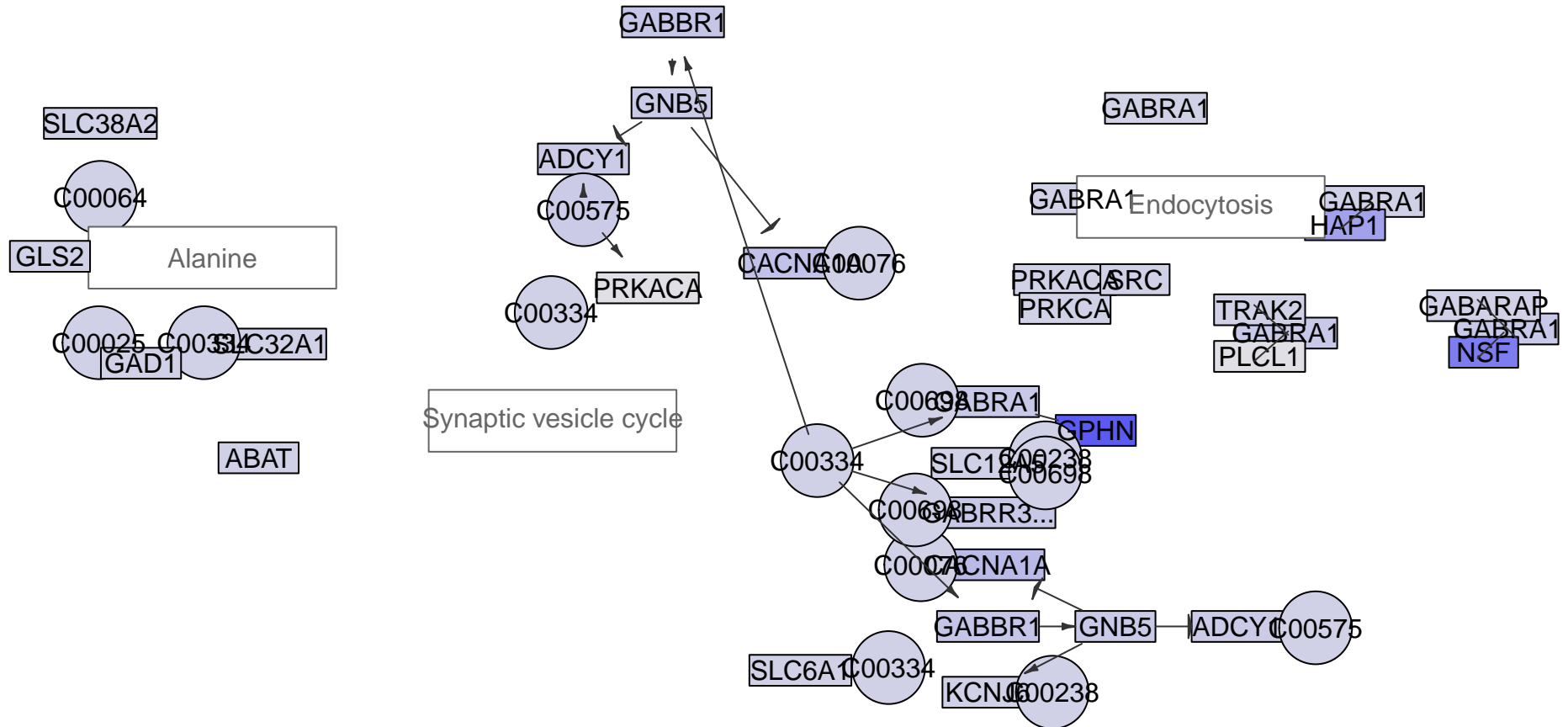
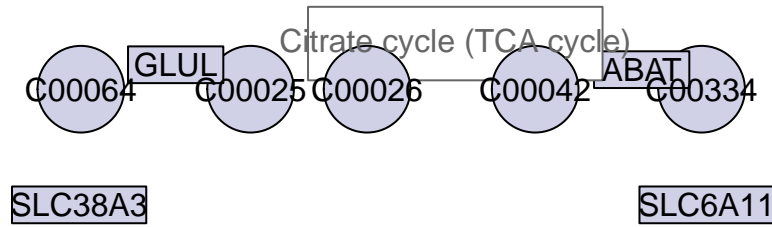

GABAergic synapse
MPI-086

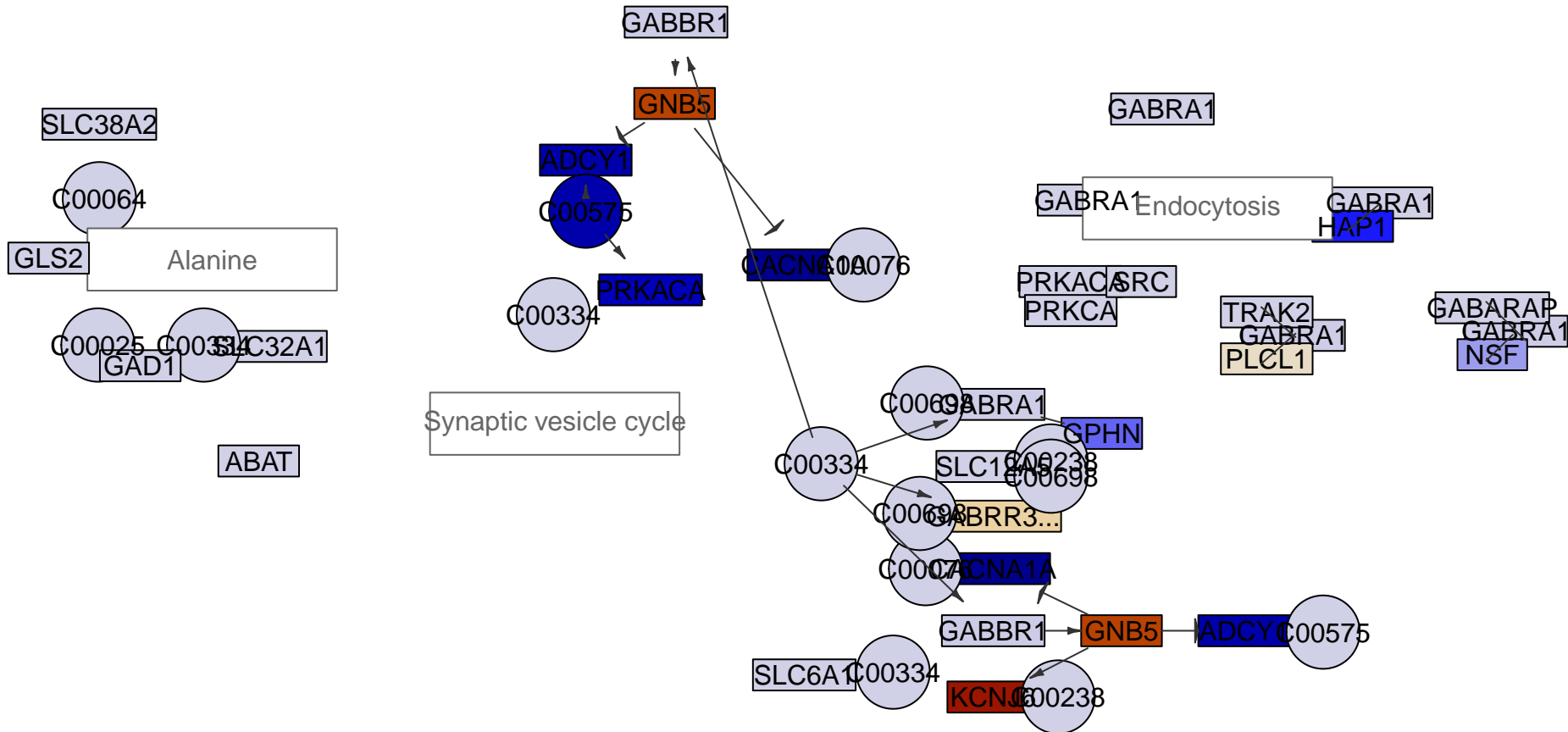
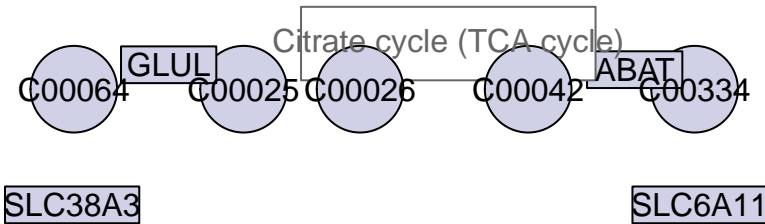

GABAergic synapse
MPI-087

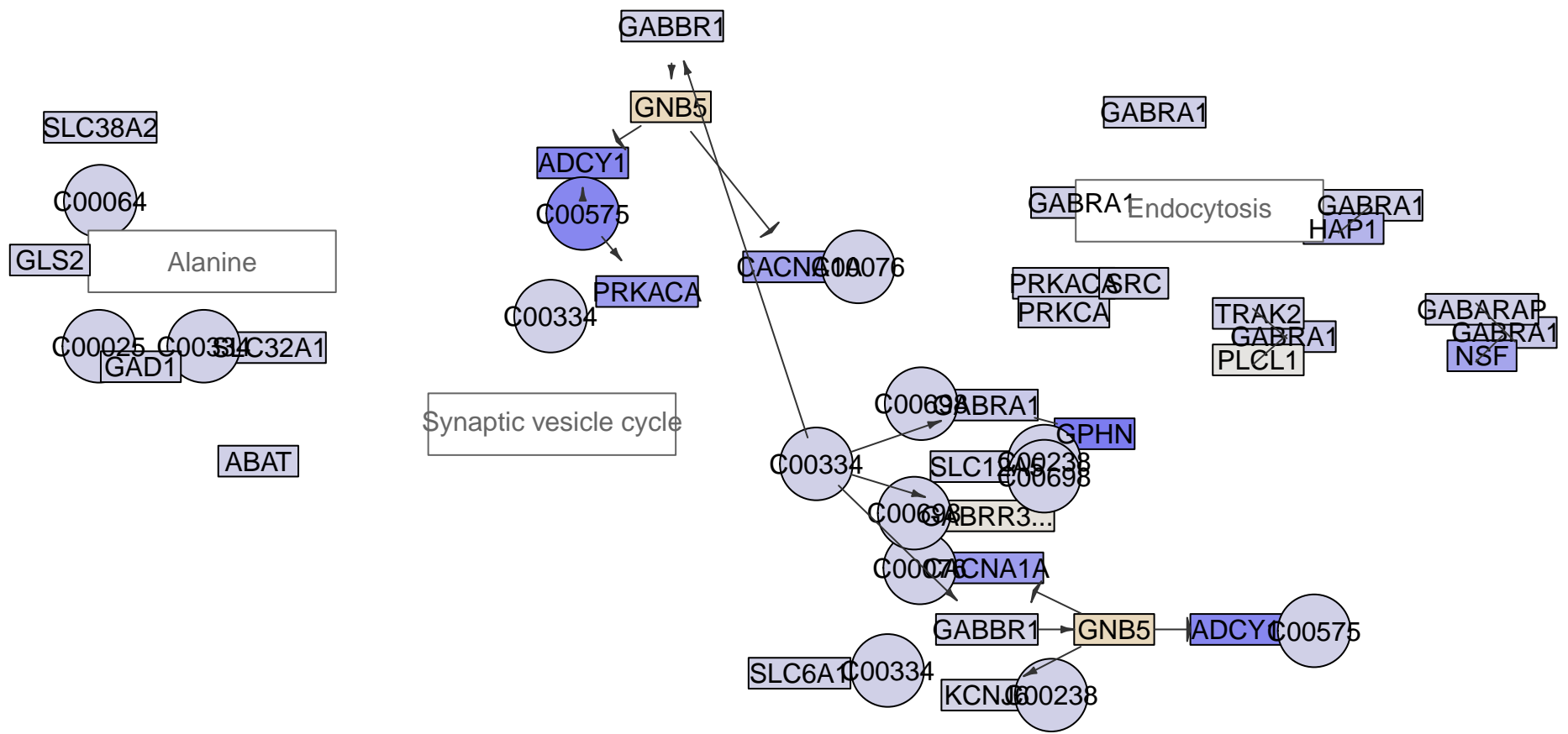

GABAergic synapse
MPI-089

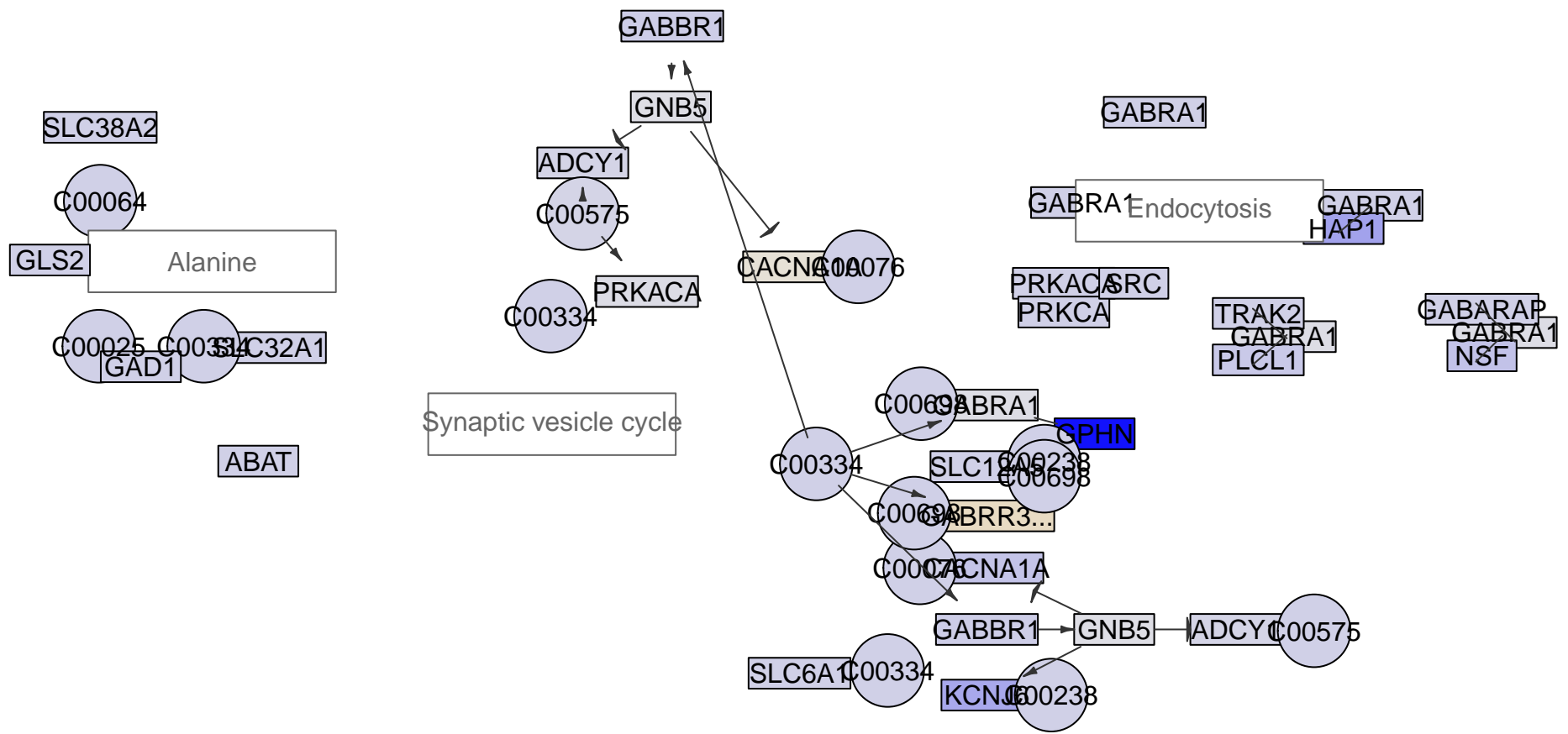

GABAergic synapse
MPI-090

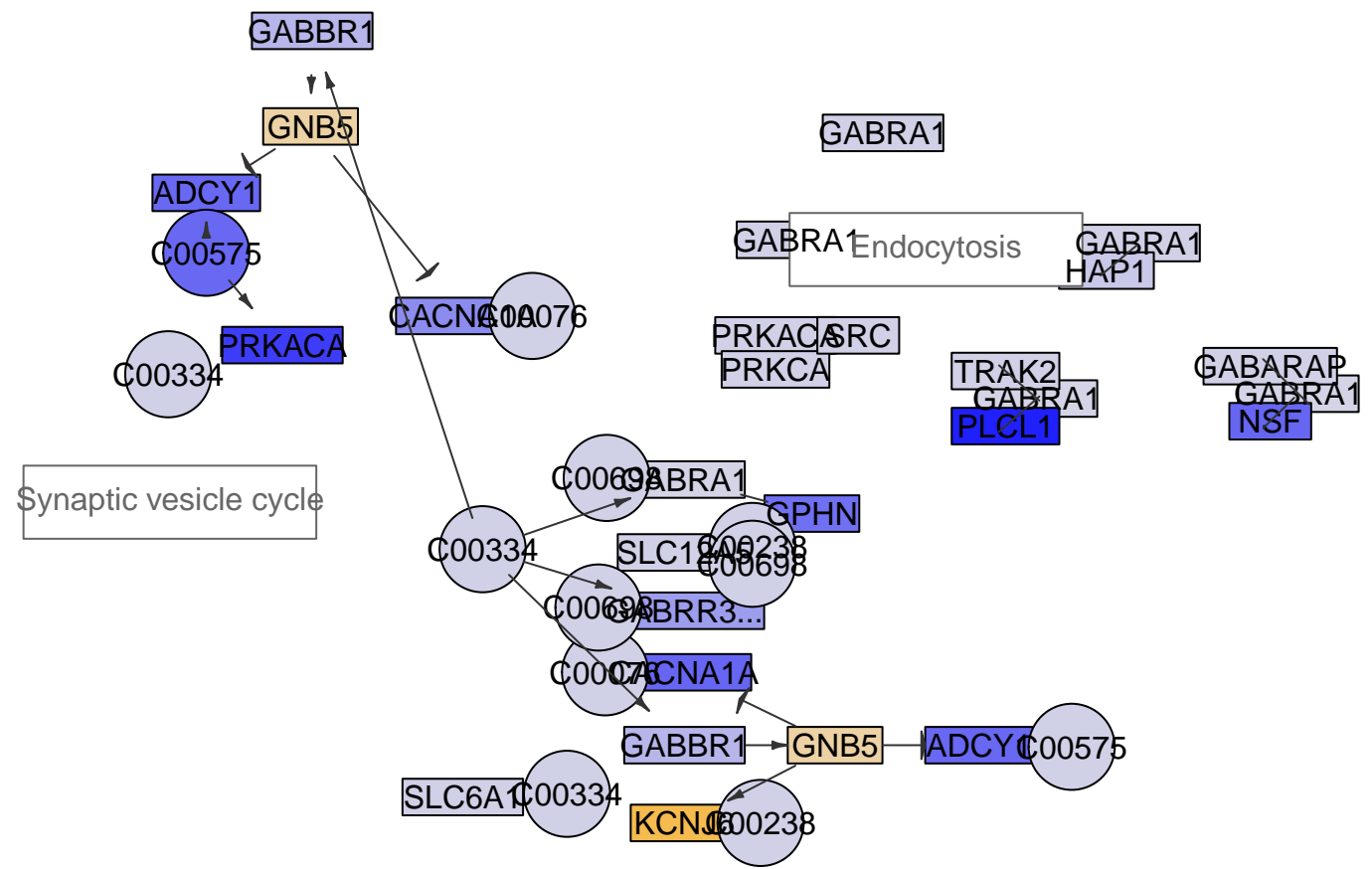
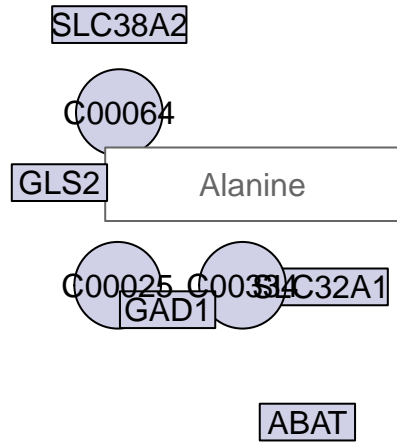

GABAergic synapse
MPI-091

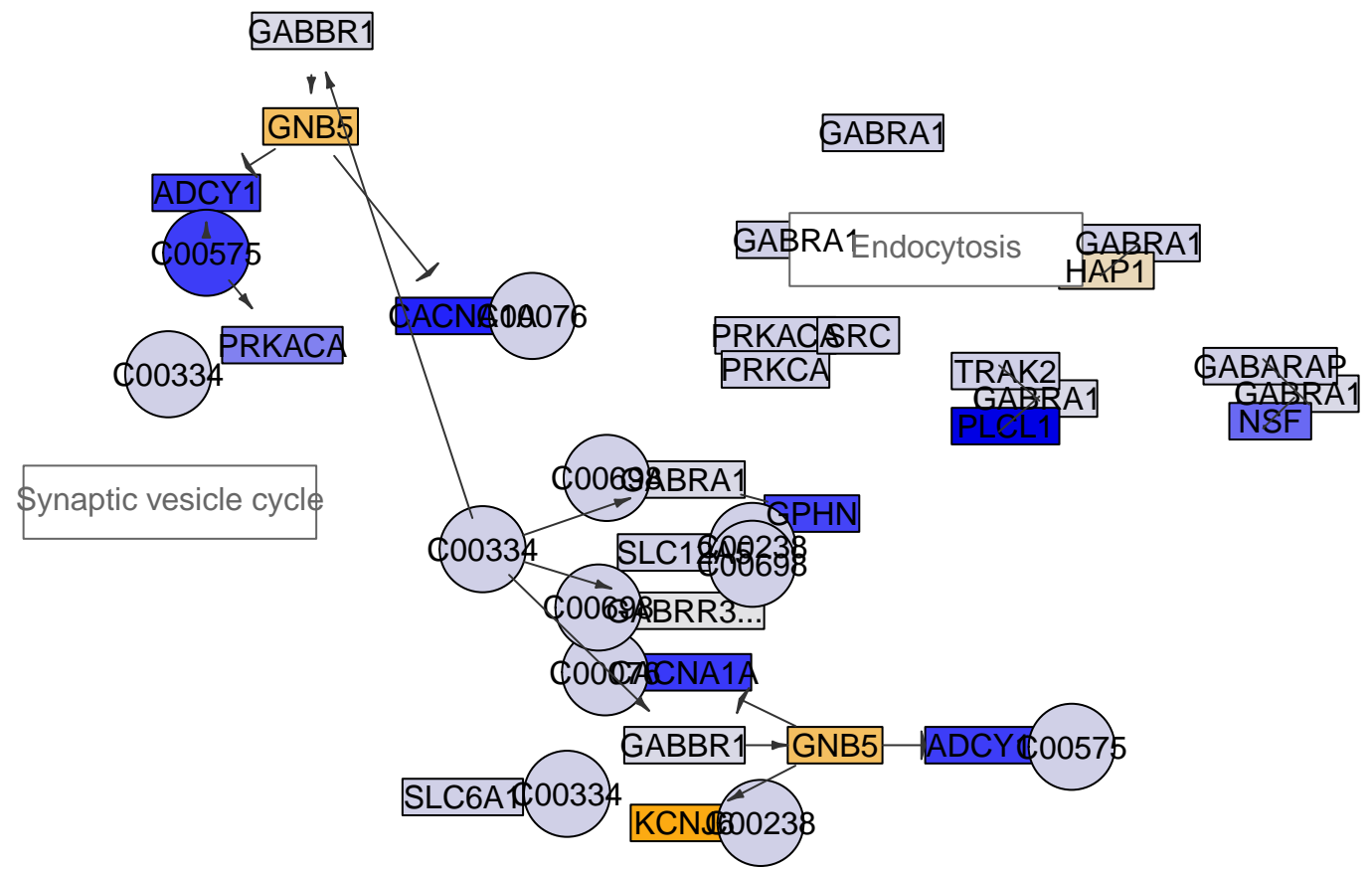
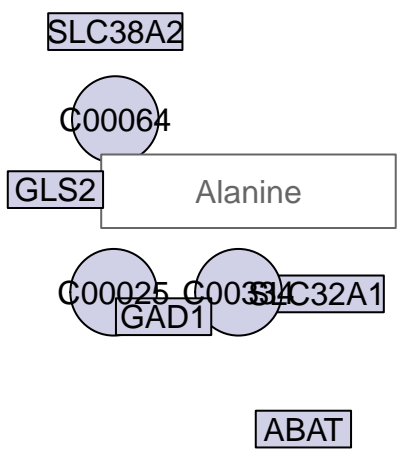

GABAergic synapse
MPI-095

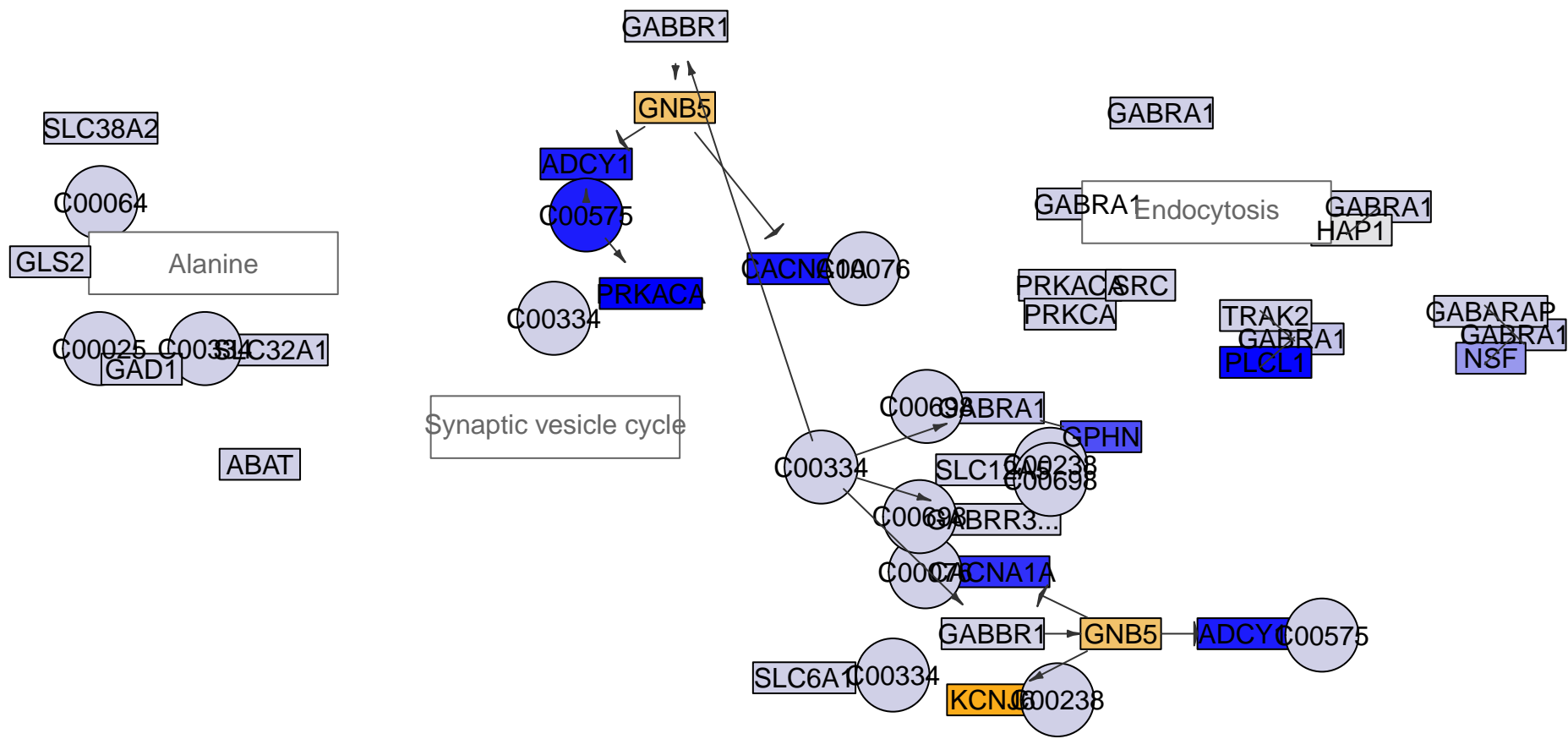

GABAergic synapse
MPI-101

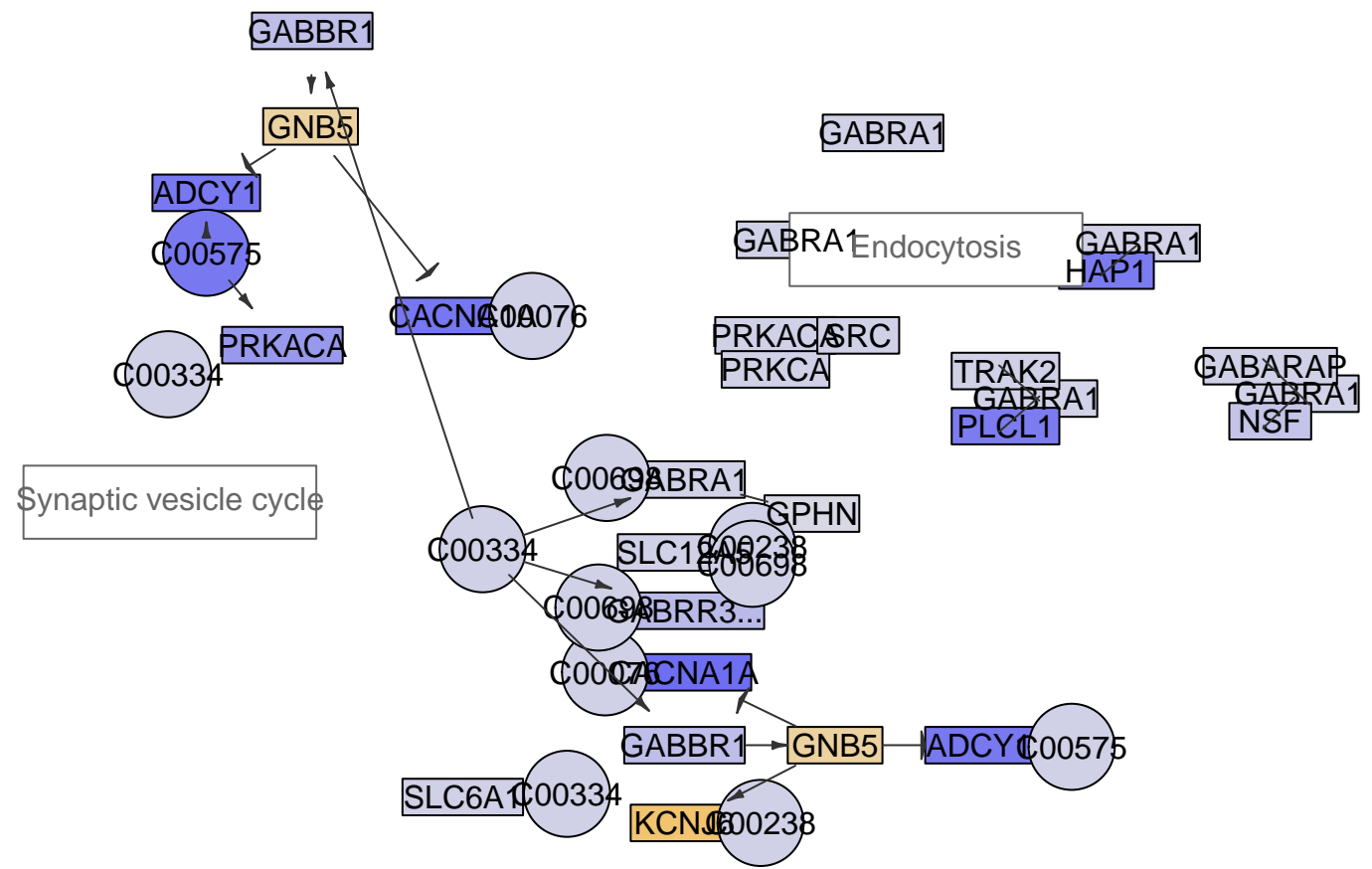
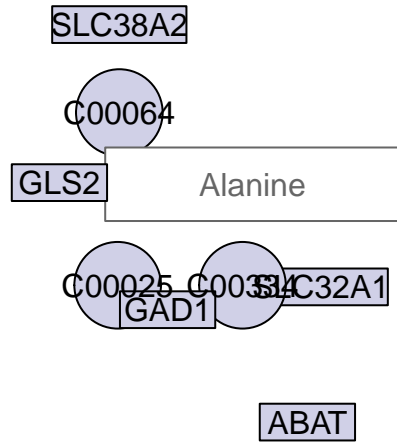

GABAergic synapse
MPI-114

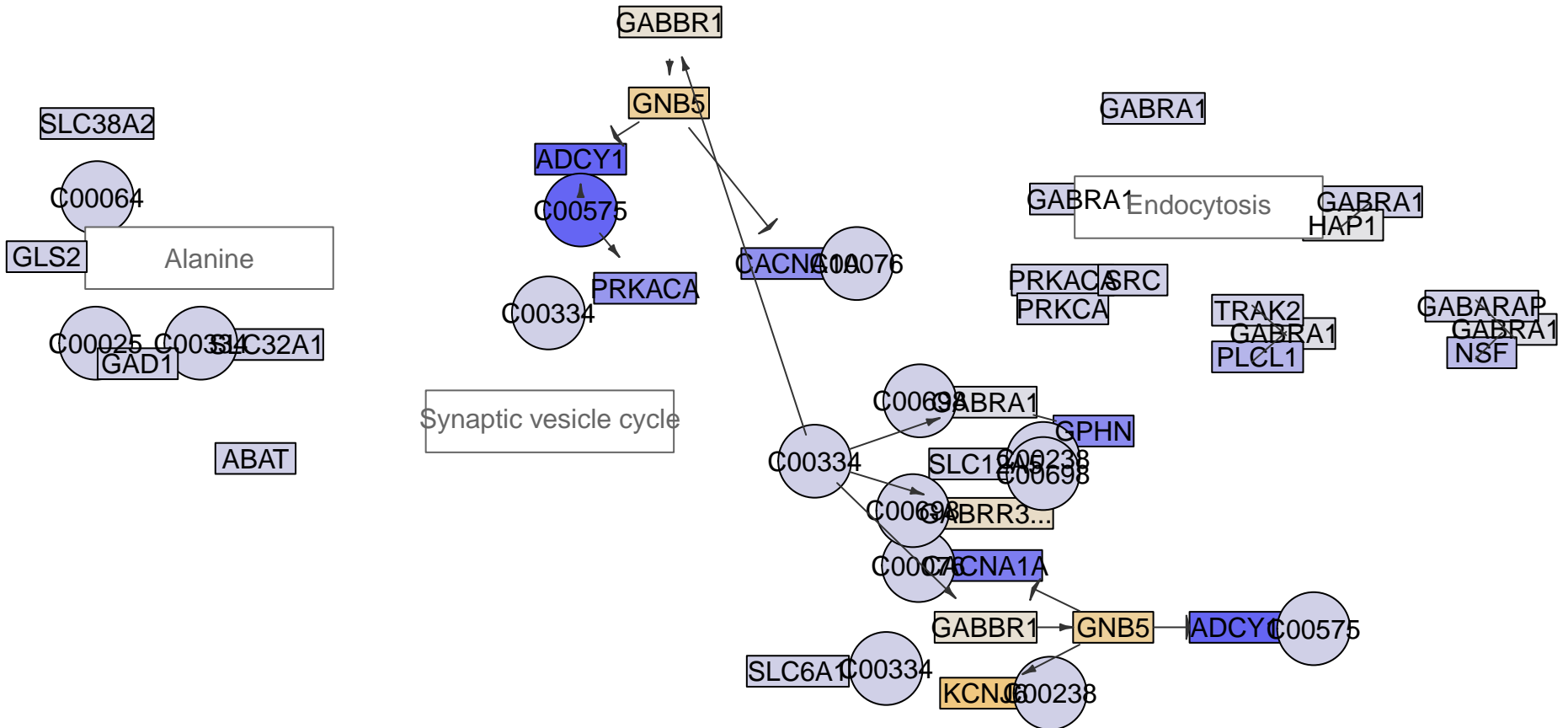
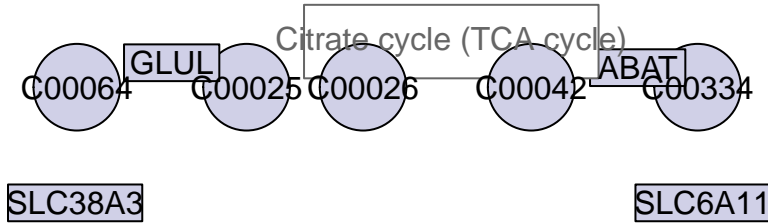

GABAergic synapse
MPI-123

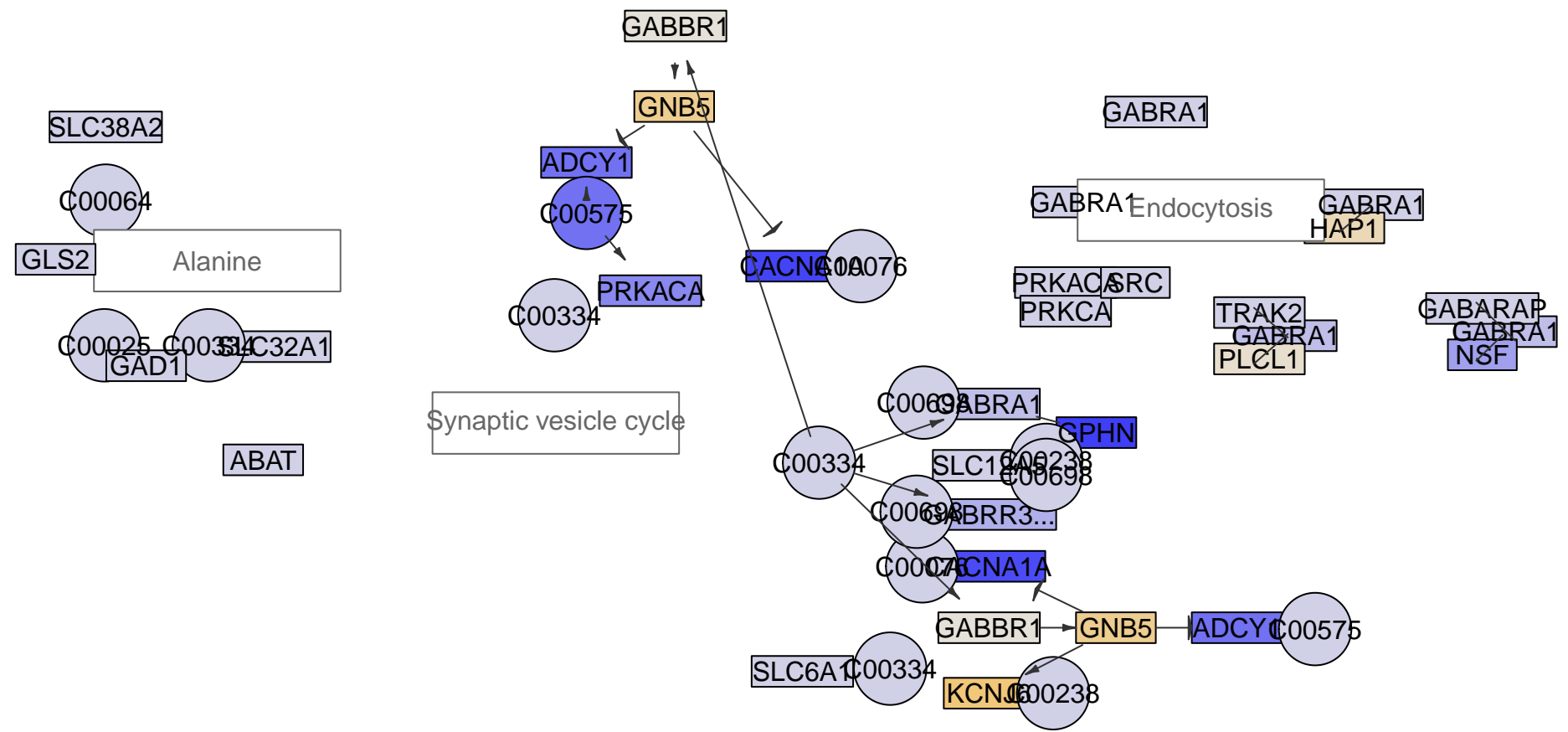

GABAergic synapse
MPI-138

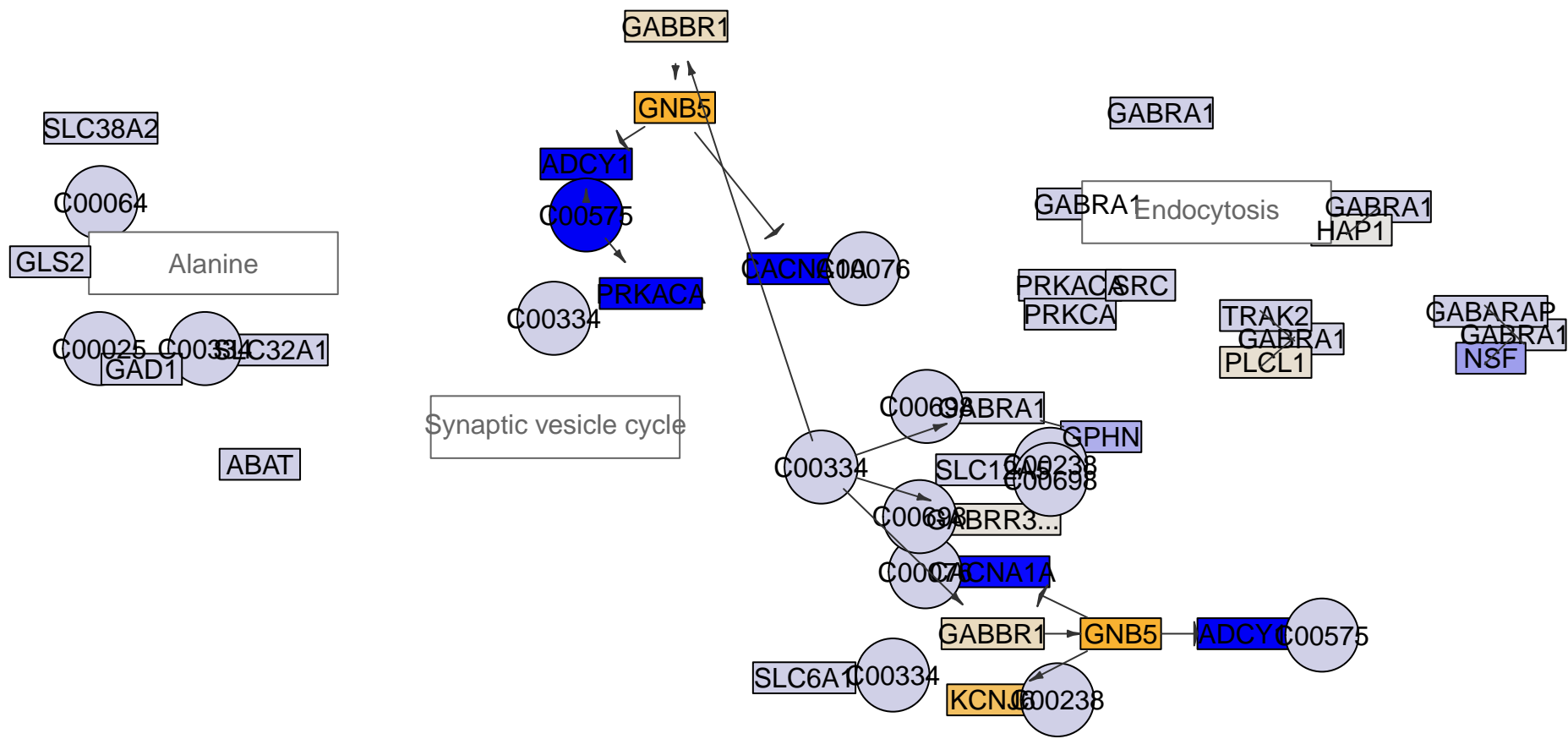

GABAergic synapse
MPI-139

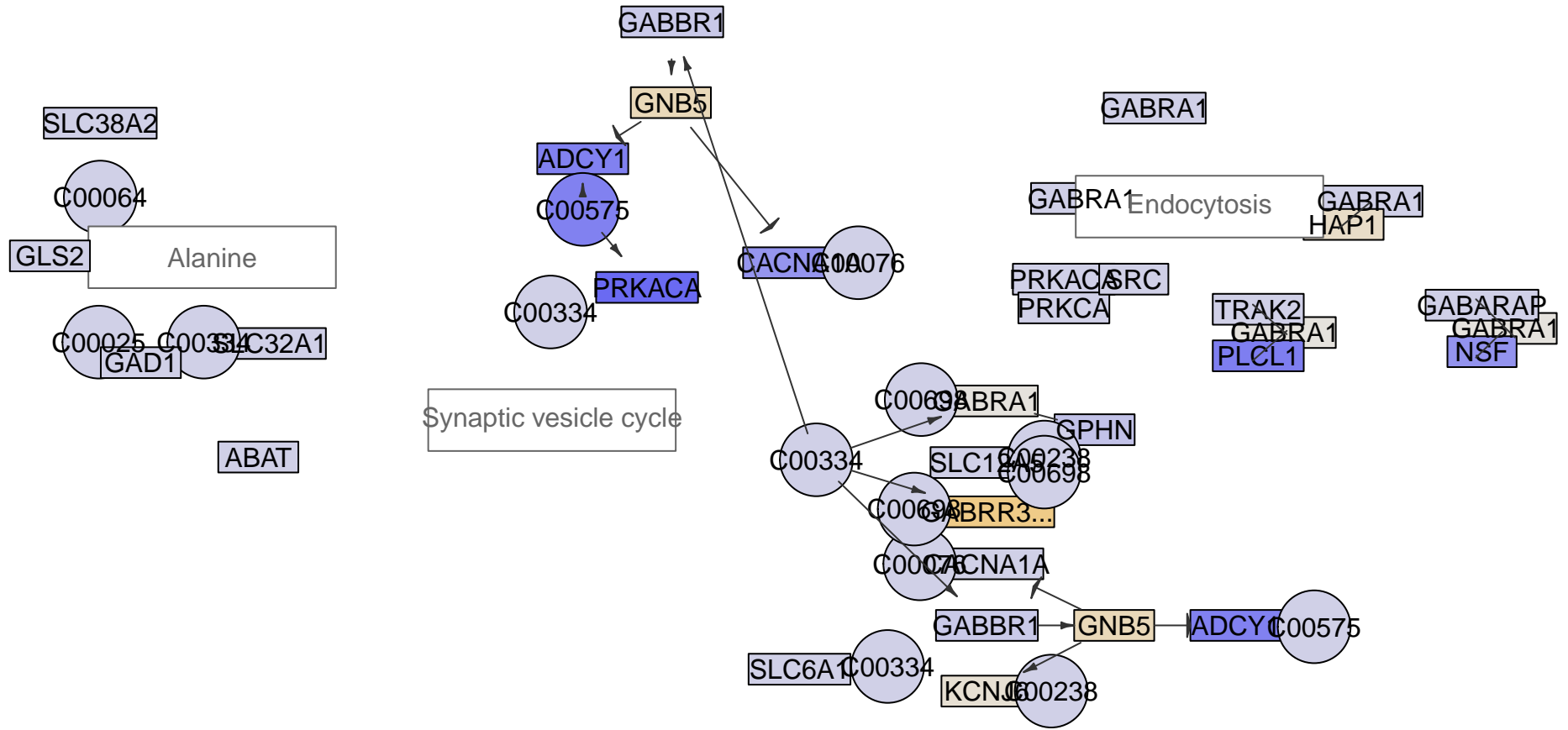

GABAergic synapse
MPI-140

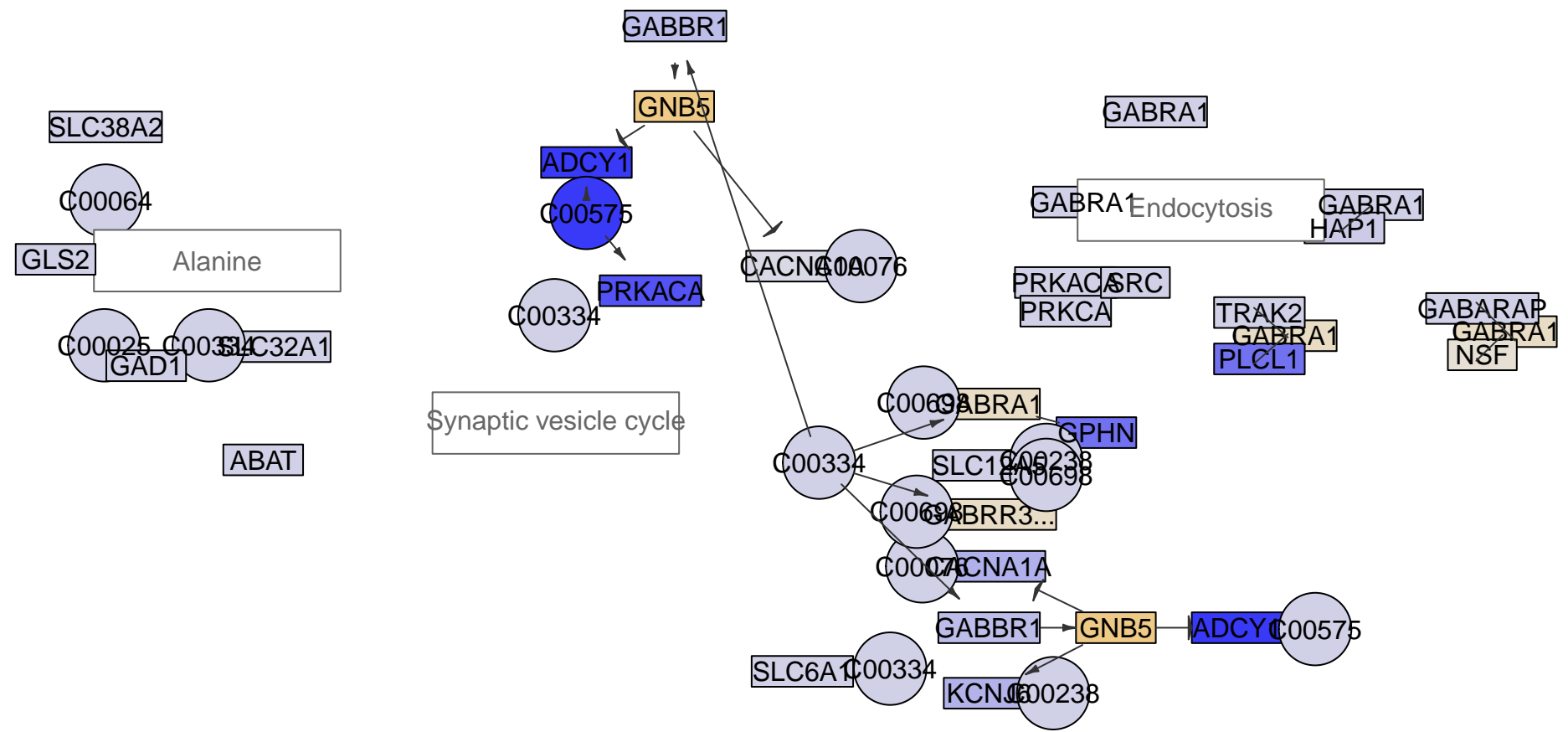

GABAergic synapse
MPI-144

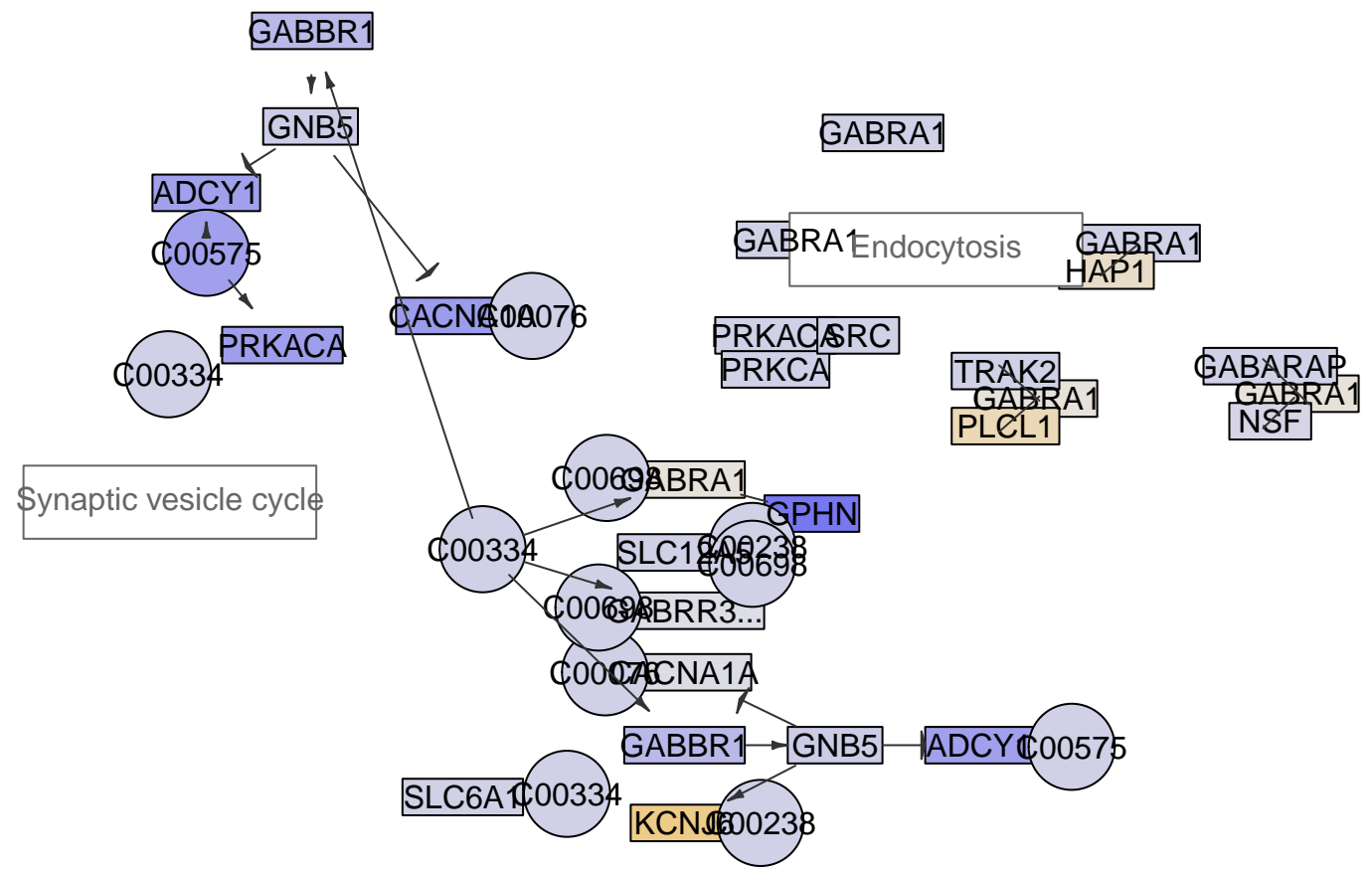
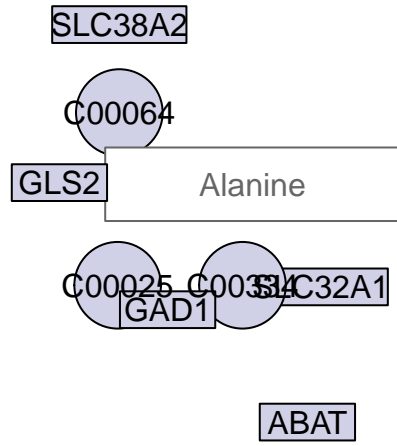

GABAergic synapse
MPI-147

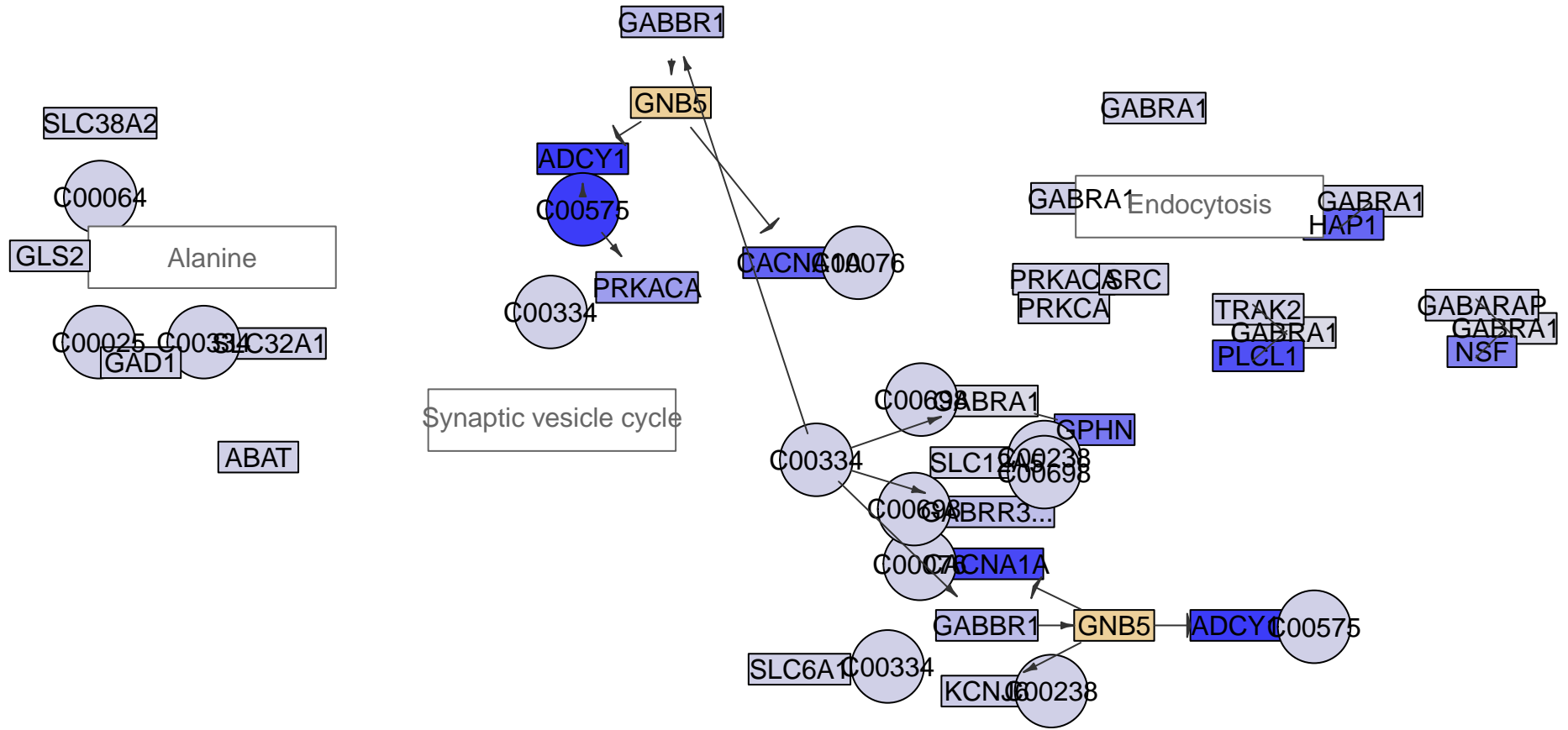

GABAergic synapse
MPI-171

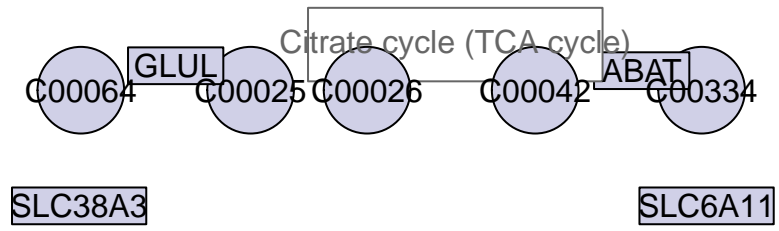

SLC38A3

SLC6A11

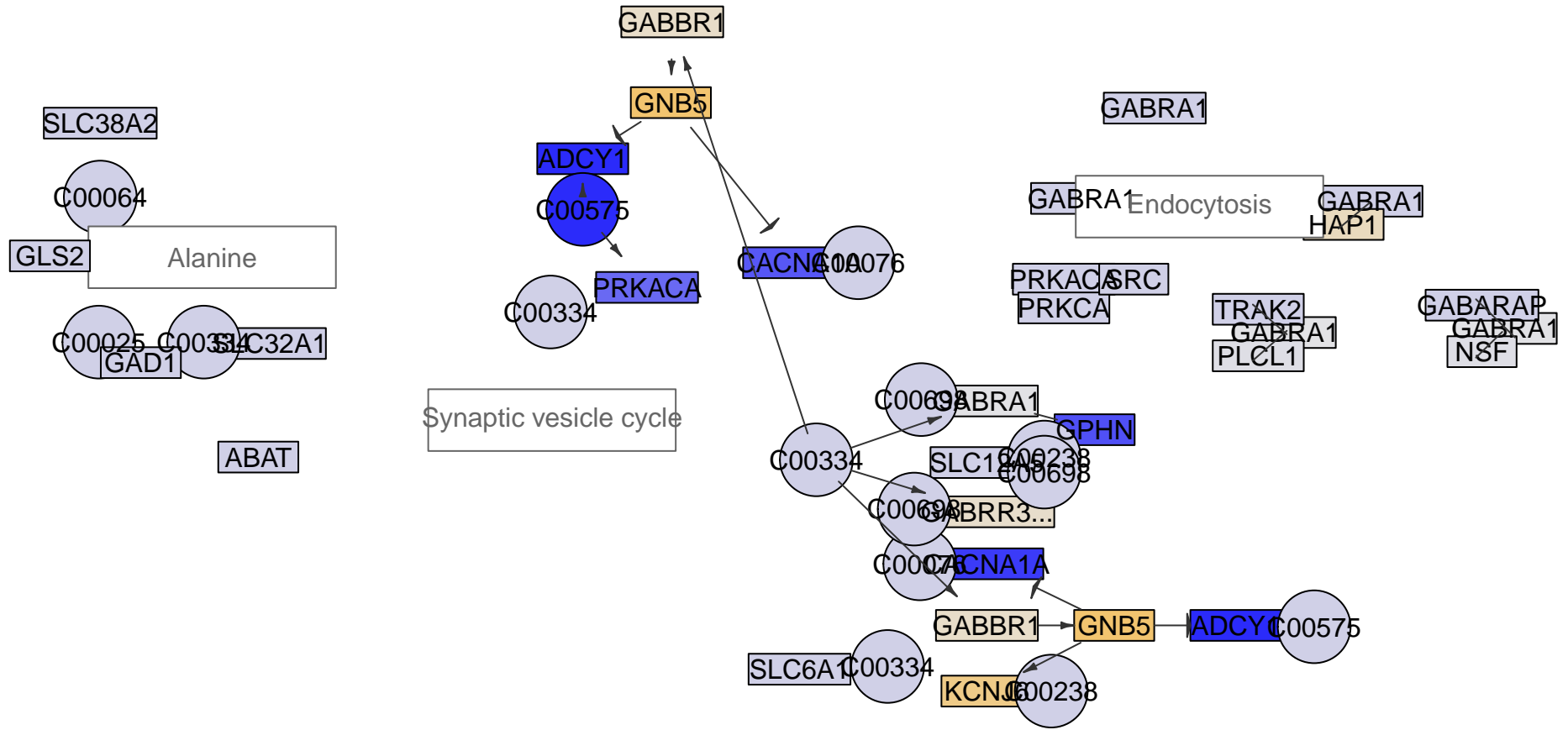

GABAergic synapse
MPI-172

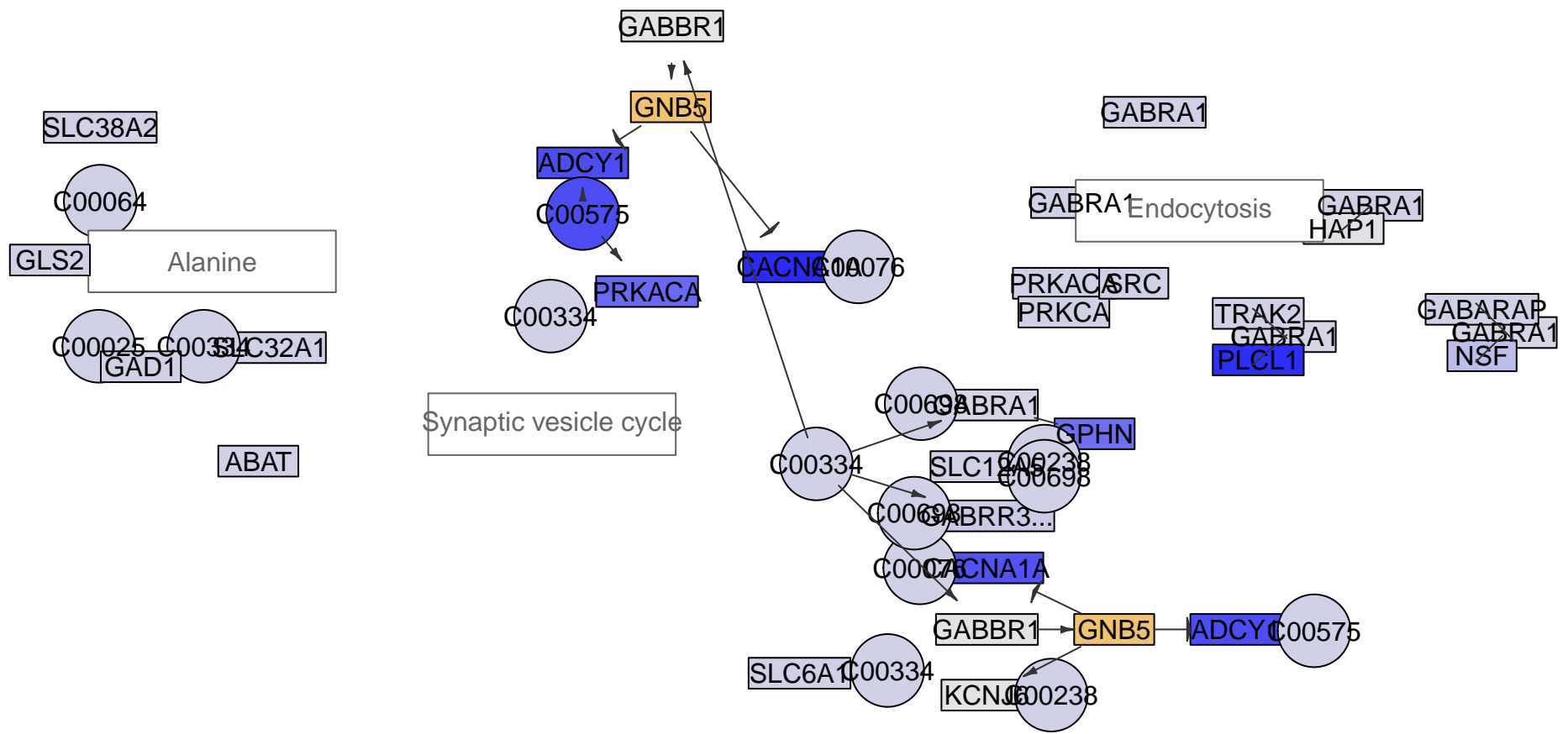

GABAergic synapse
MPI-007

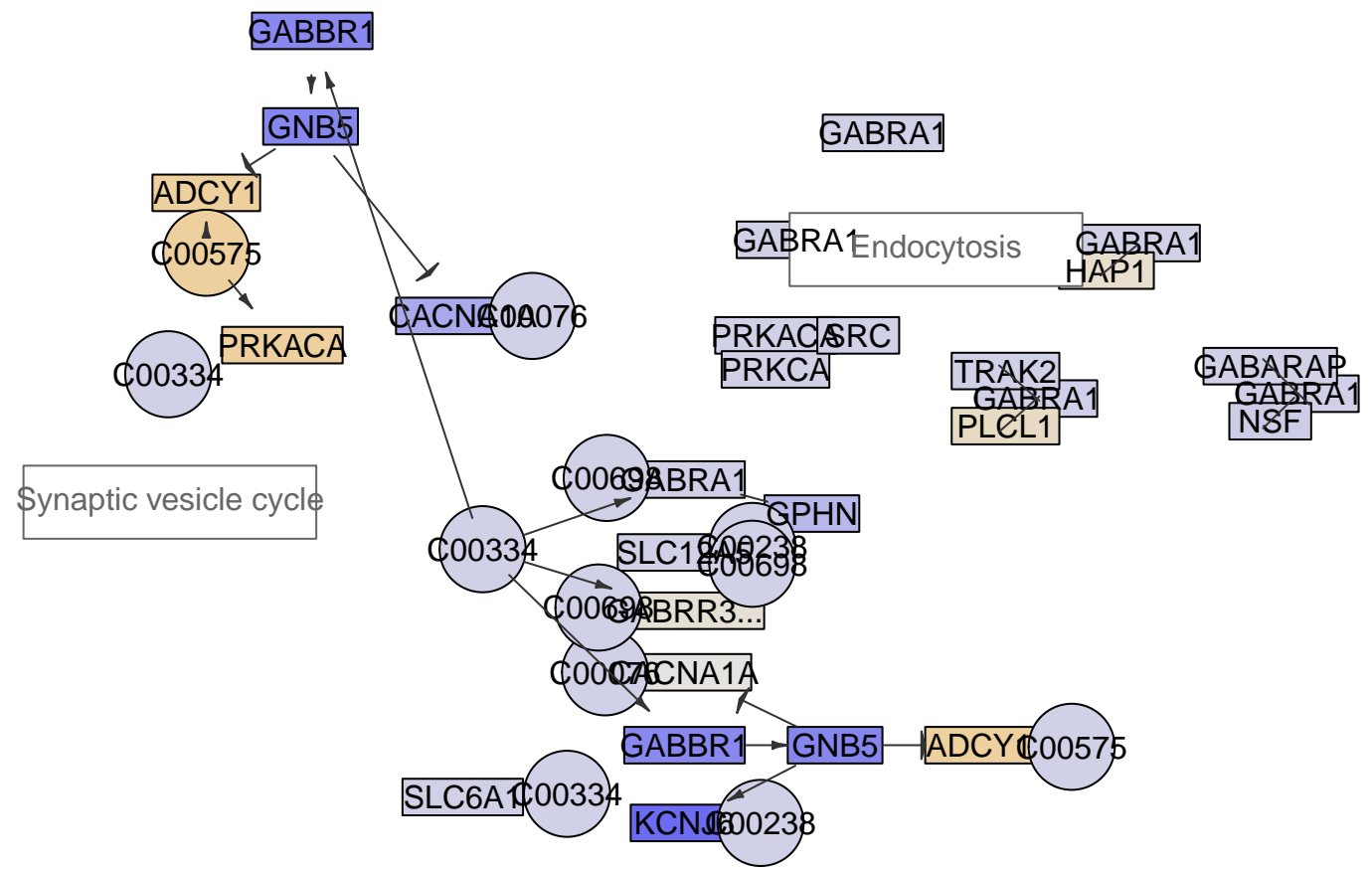
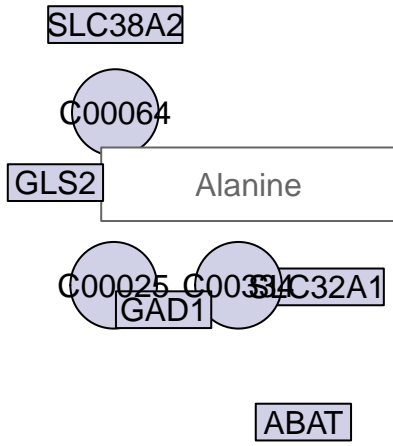

GABAergic synapse
MPI-011

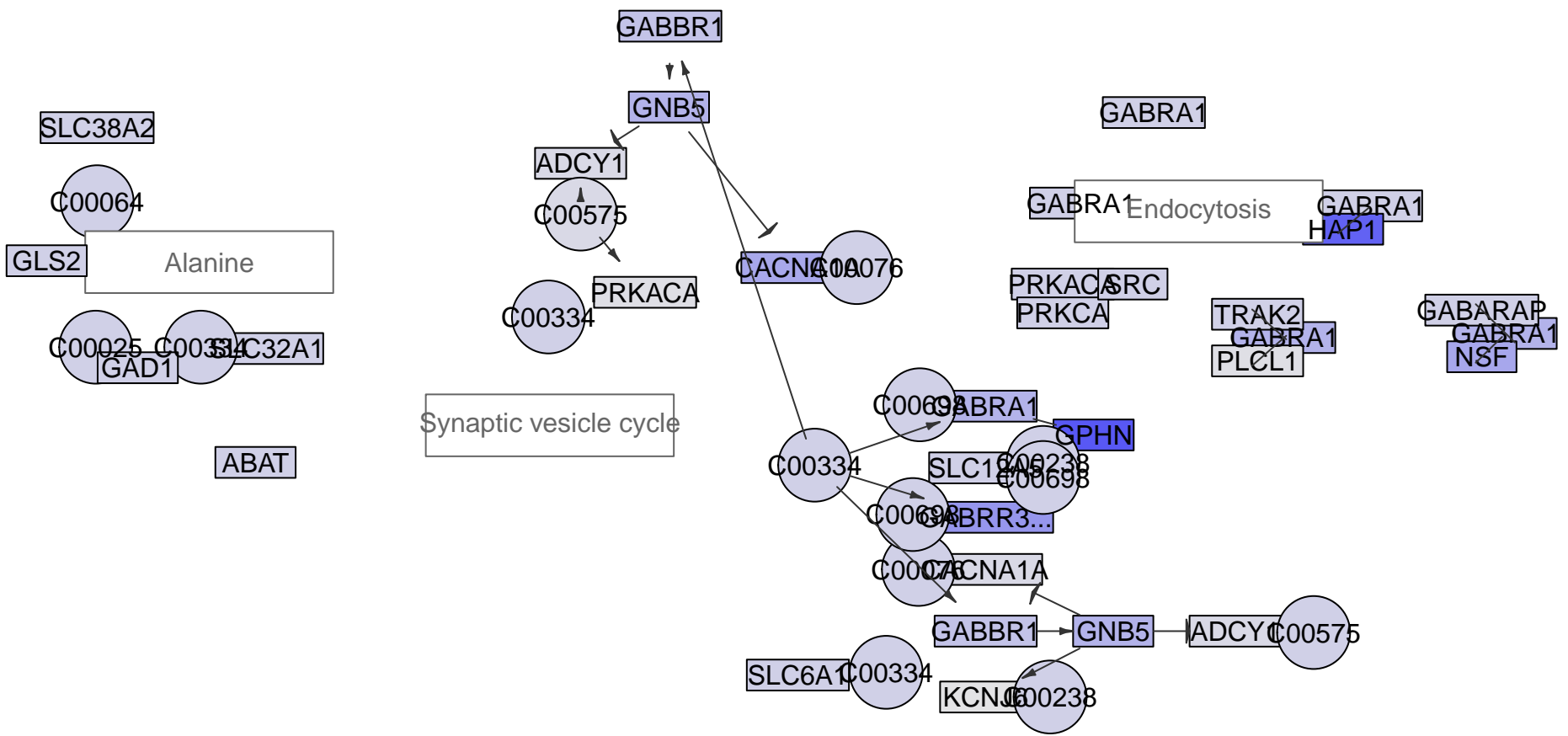

GABAergic synapse
MPI-024

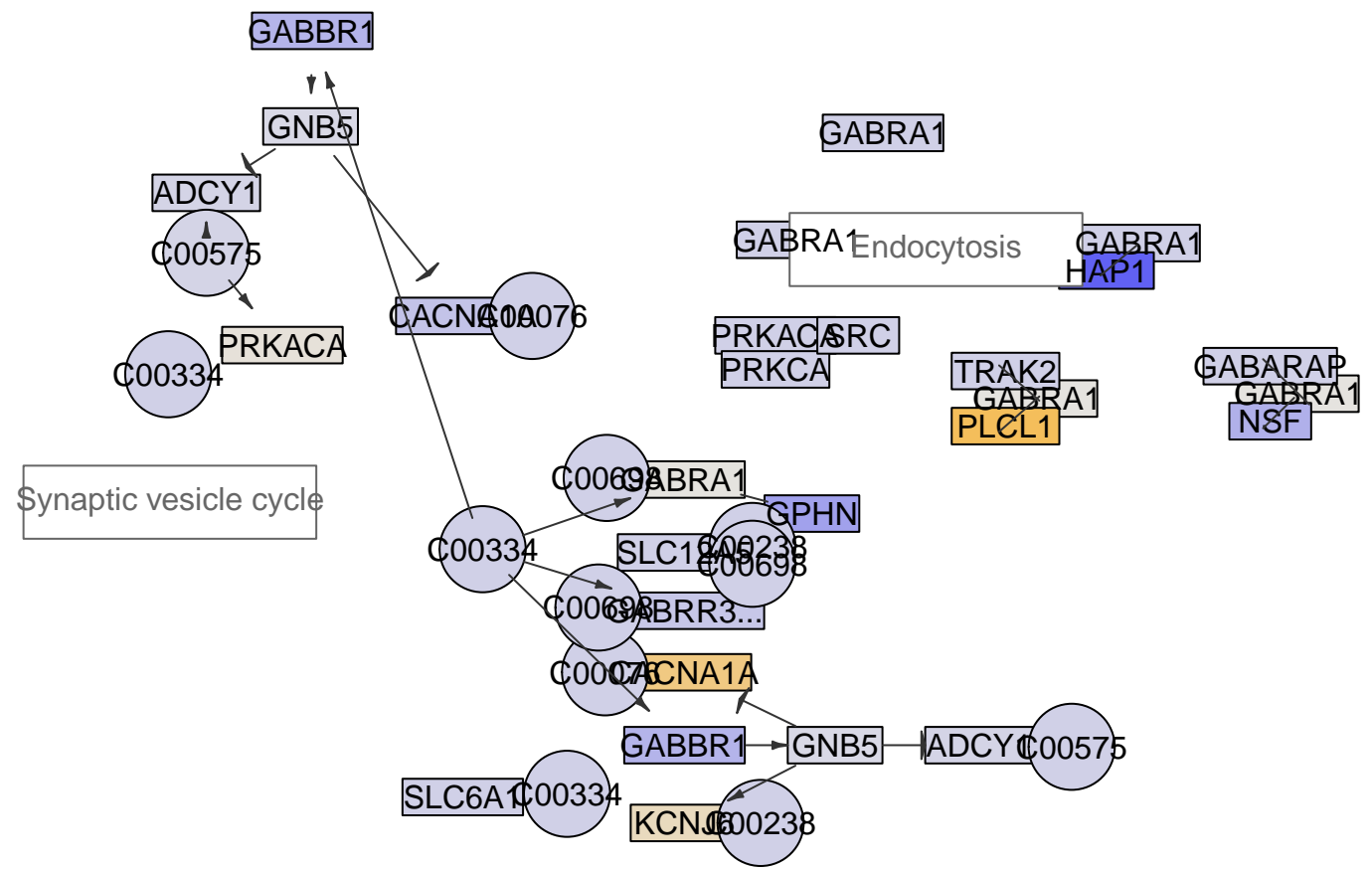
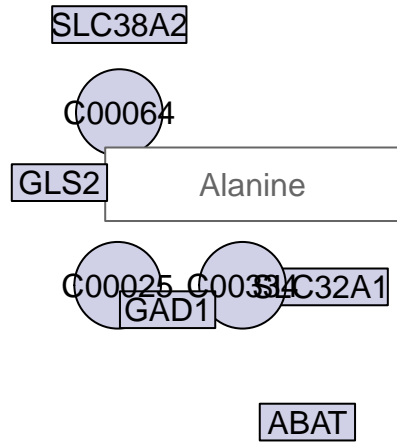

GABAergic synapse
MPI-026

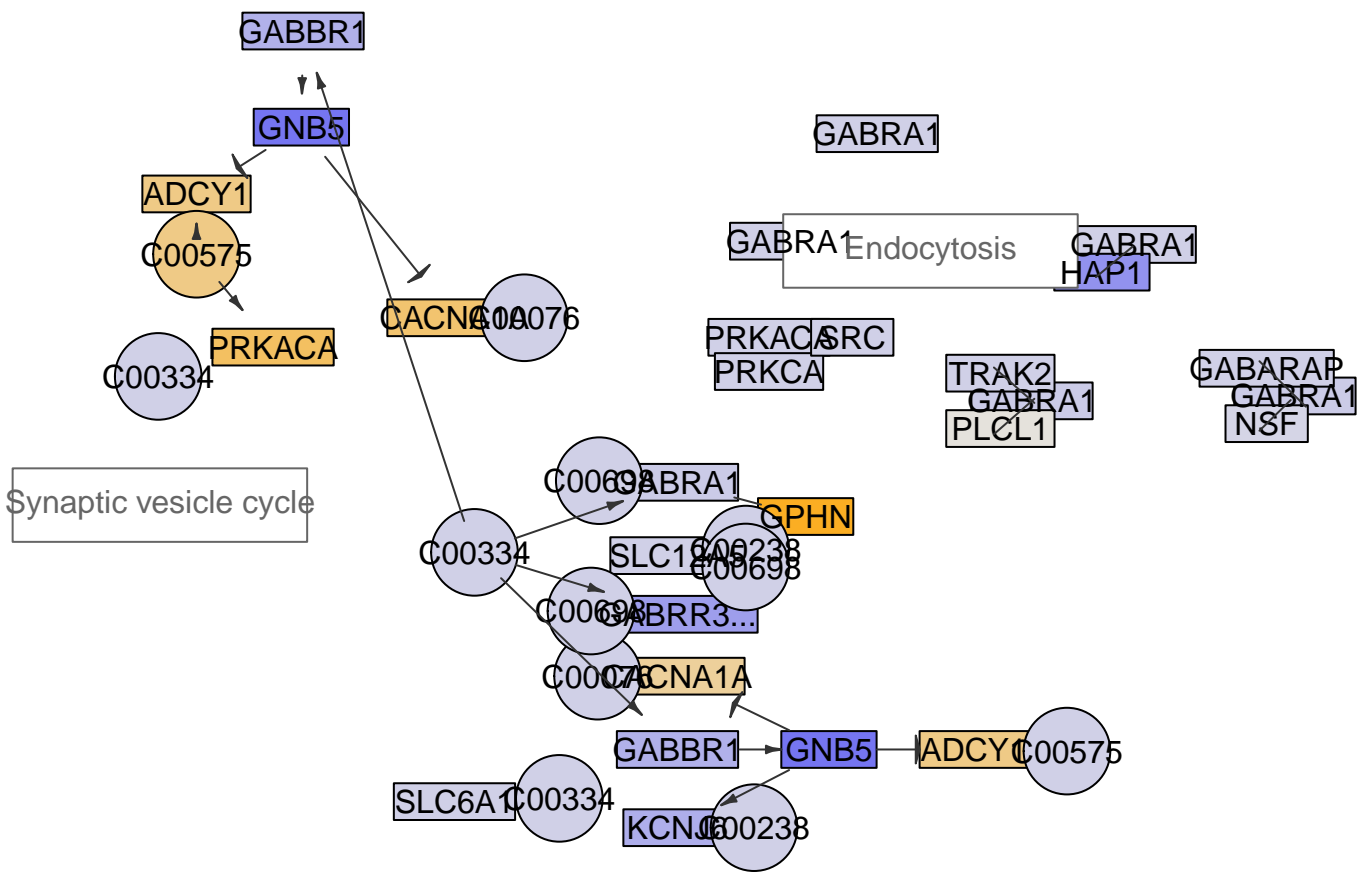
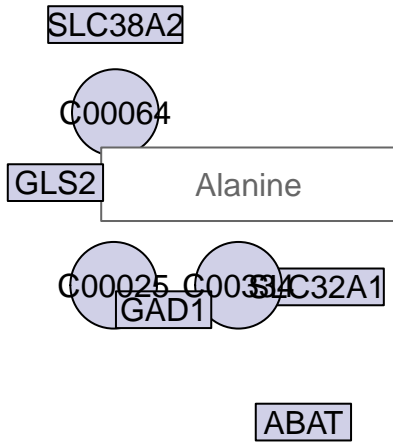

GABAergic synapse
MPI-036

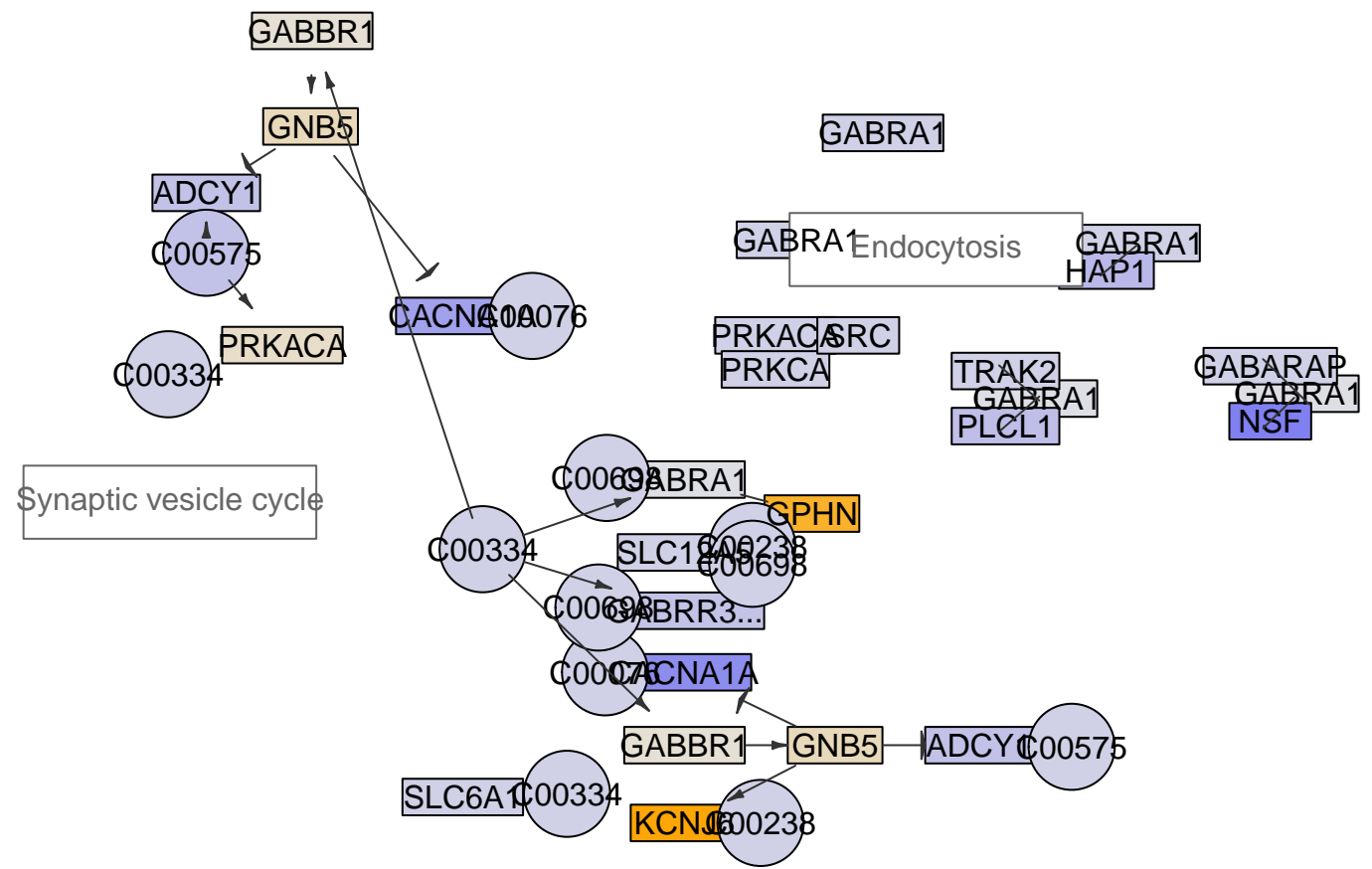
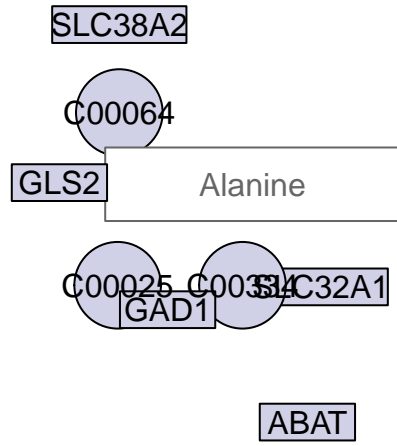

GABAergic synapse
MPI-037

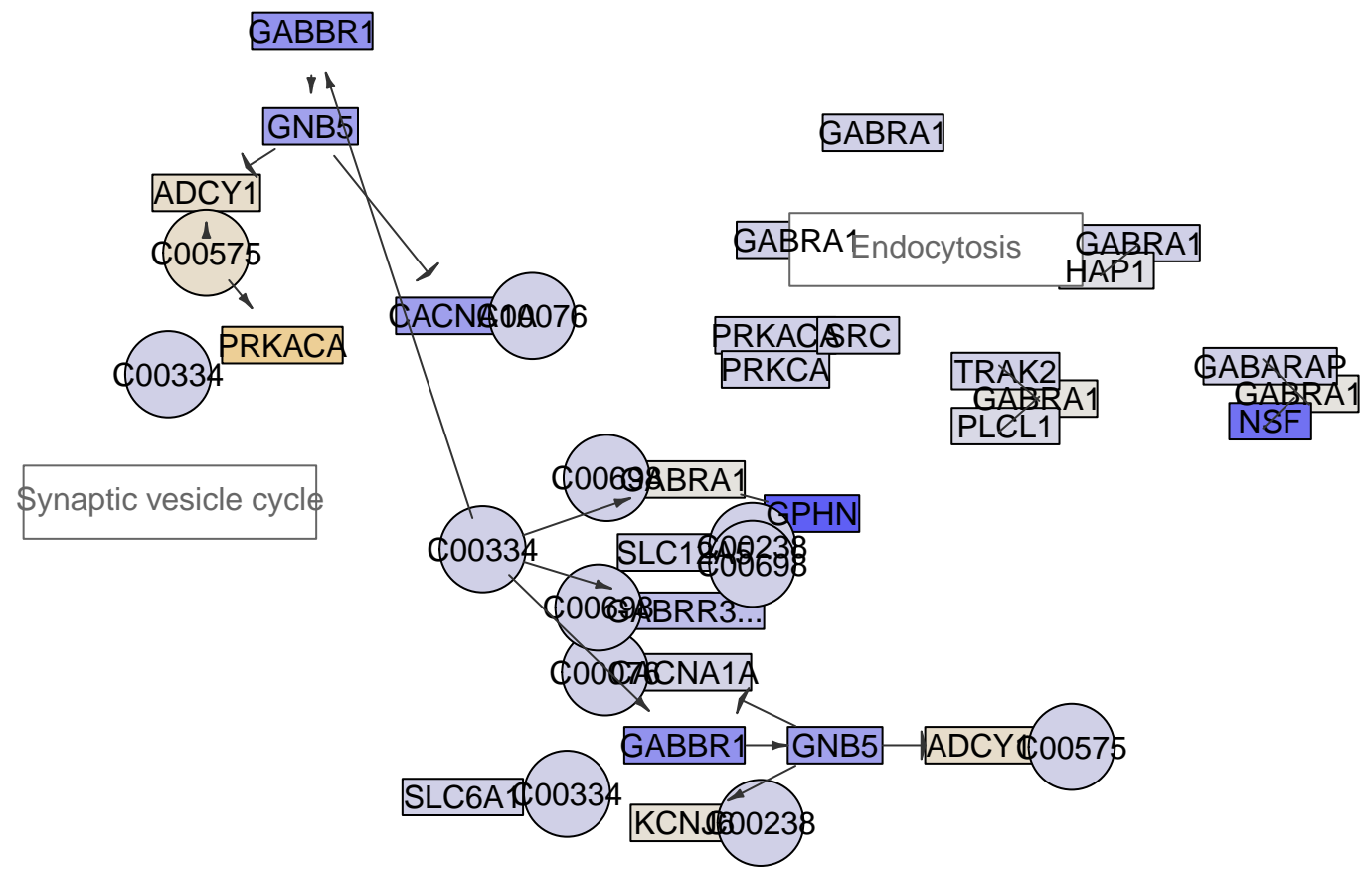
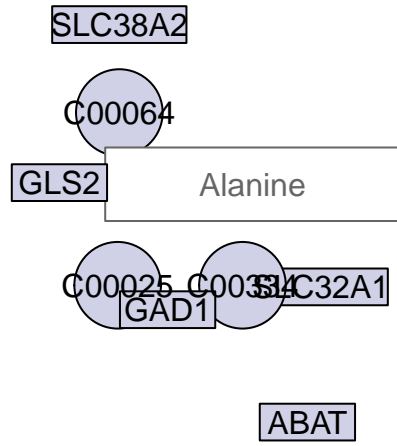

GABAergic synapse
MPI-038

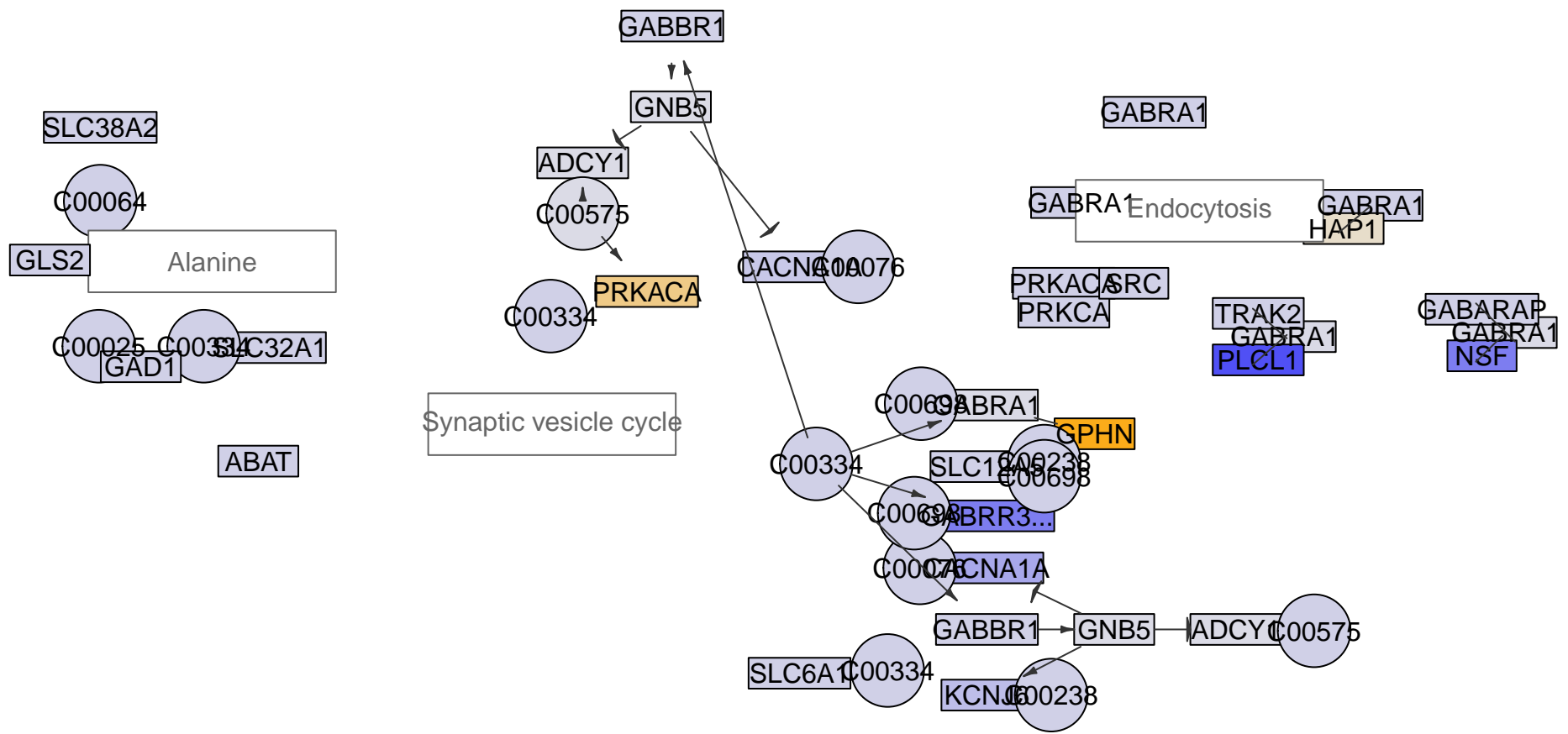

GABAergic synapse
MPI-041

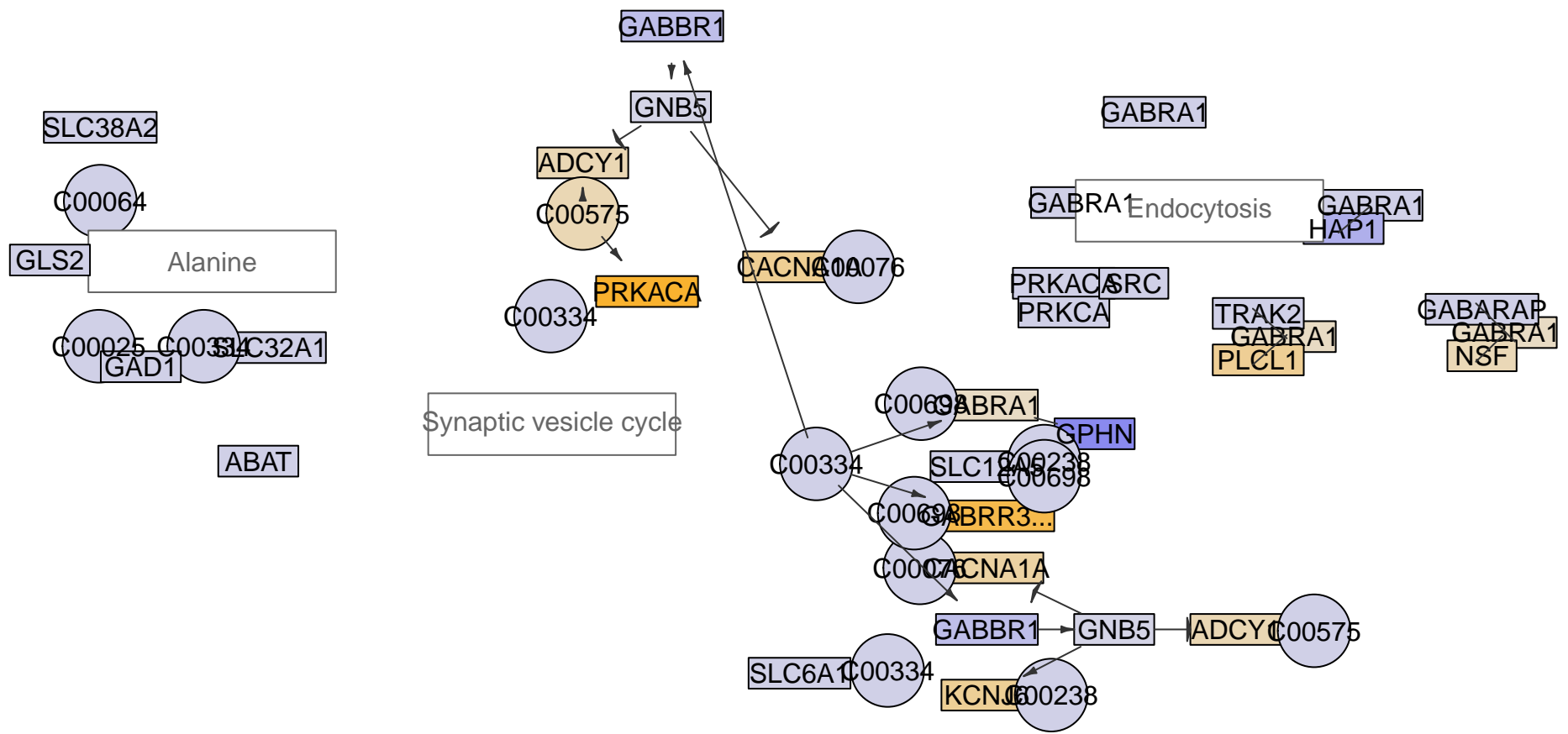

GABAergic synapse
MPI-046

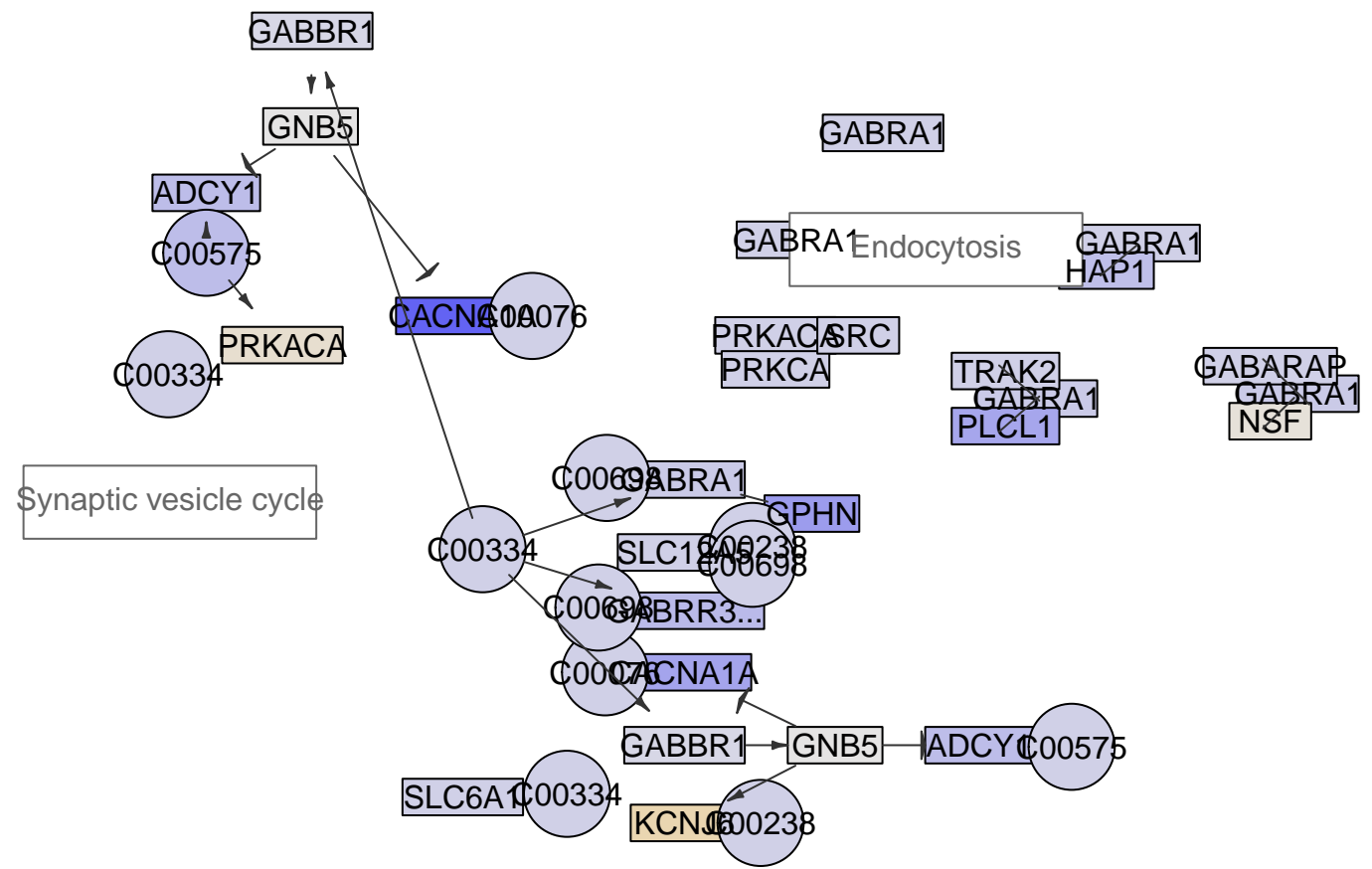
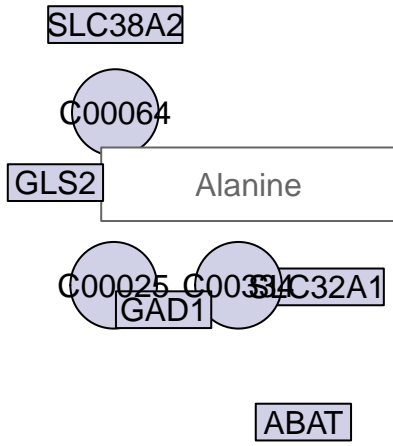

GABAergic synapse
MPI-050

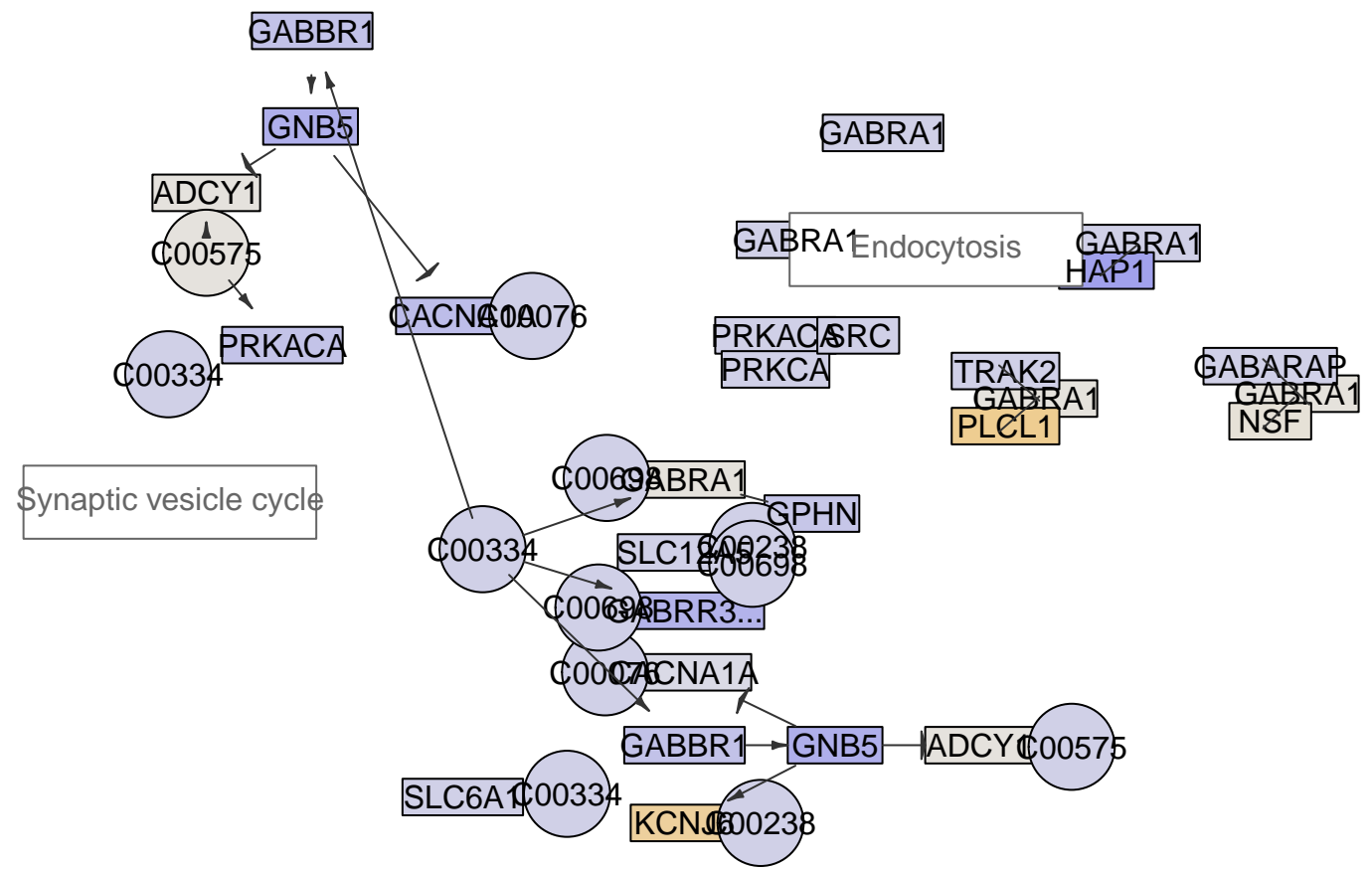
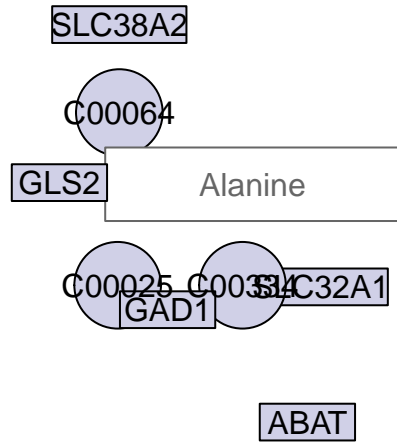

GABAergic synapse
MPI-051

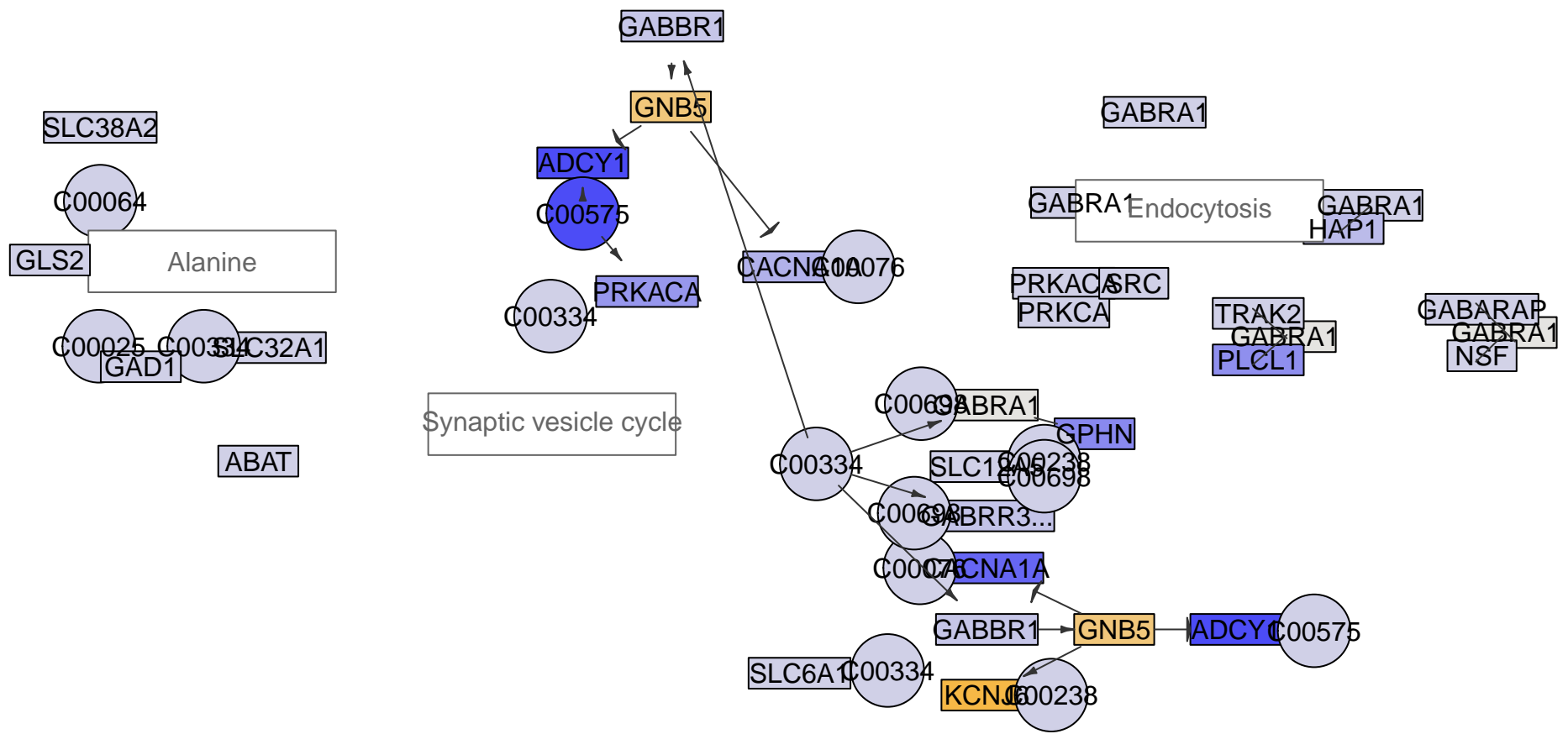

GABAergic synapse
MPI-054

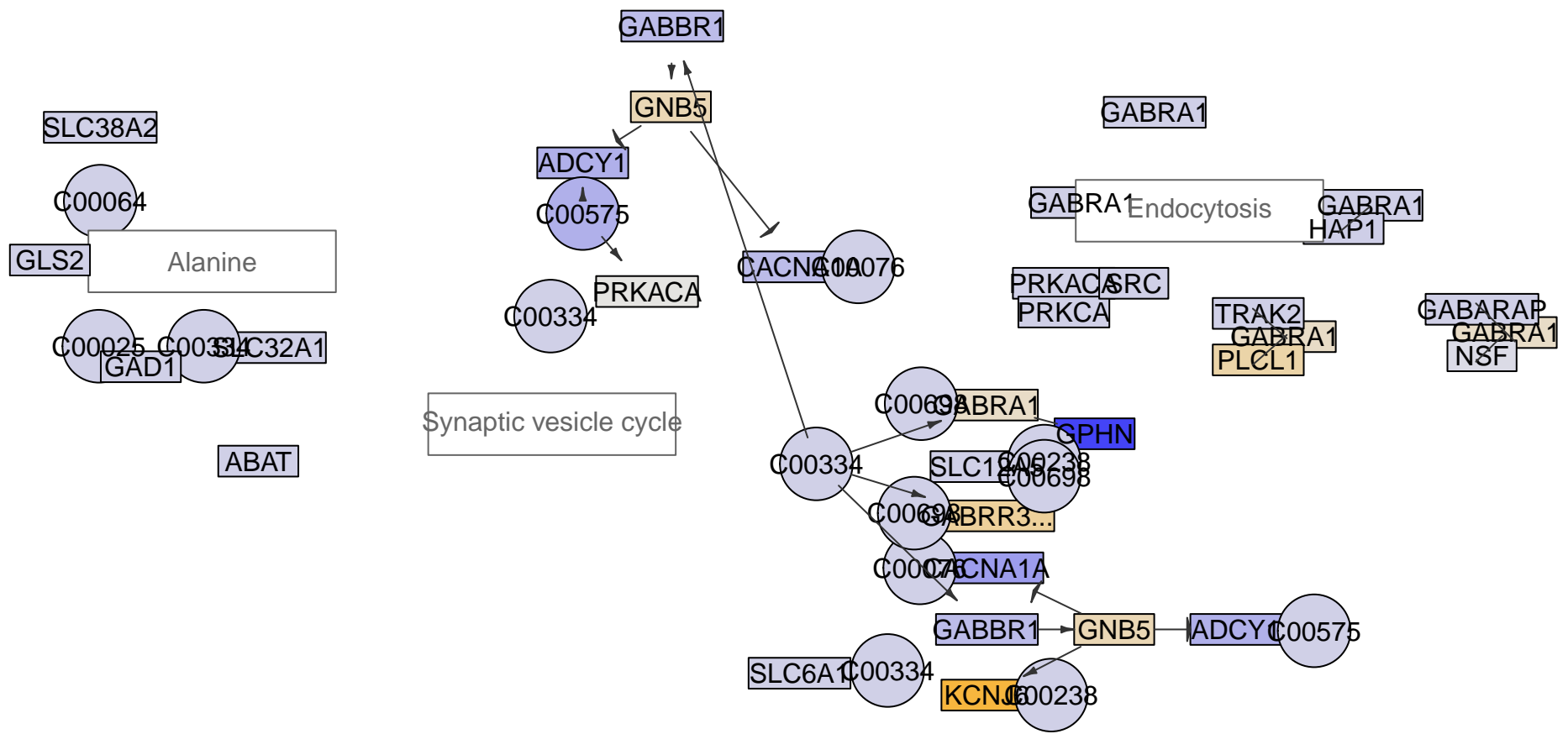

GABAergic synapse
MPI-059

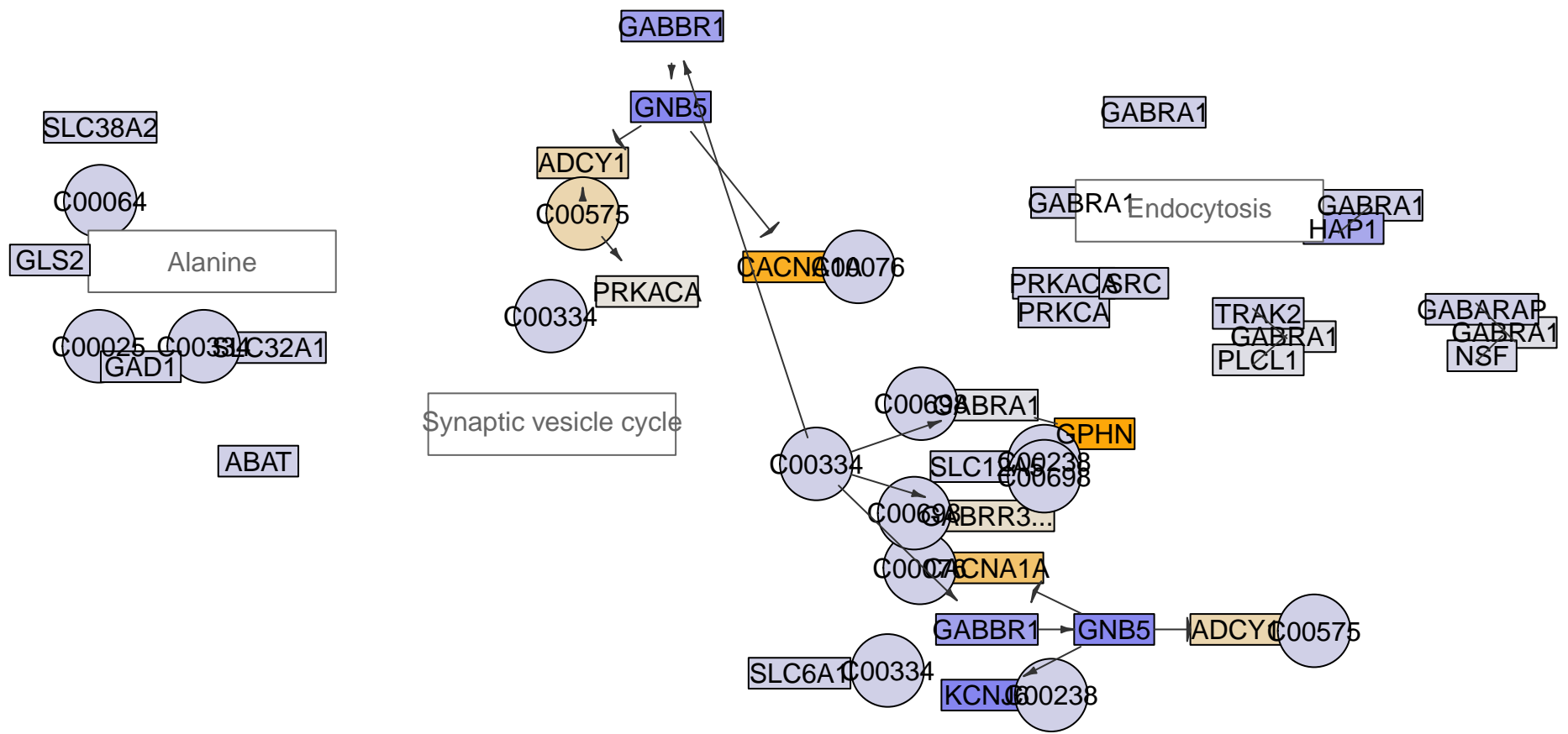

GABAergic synapse
MPI-060

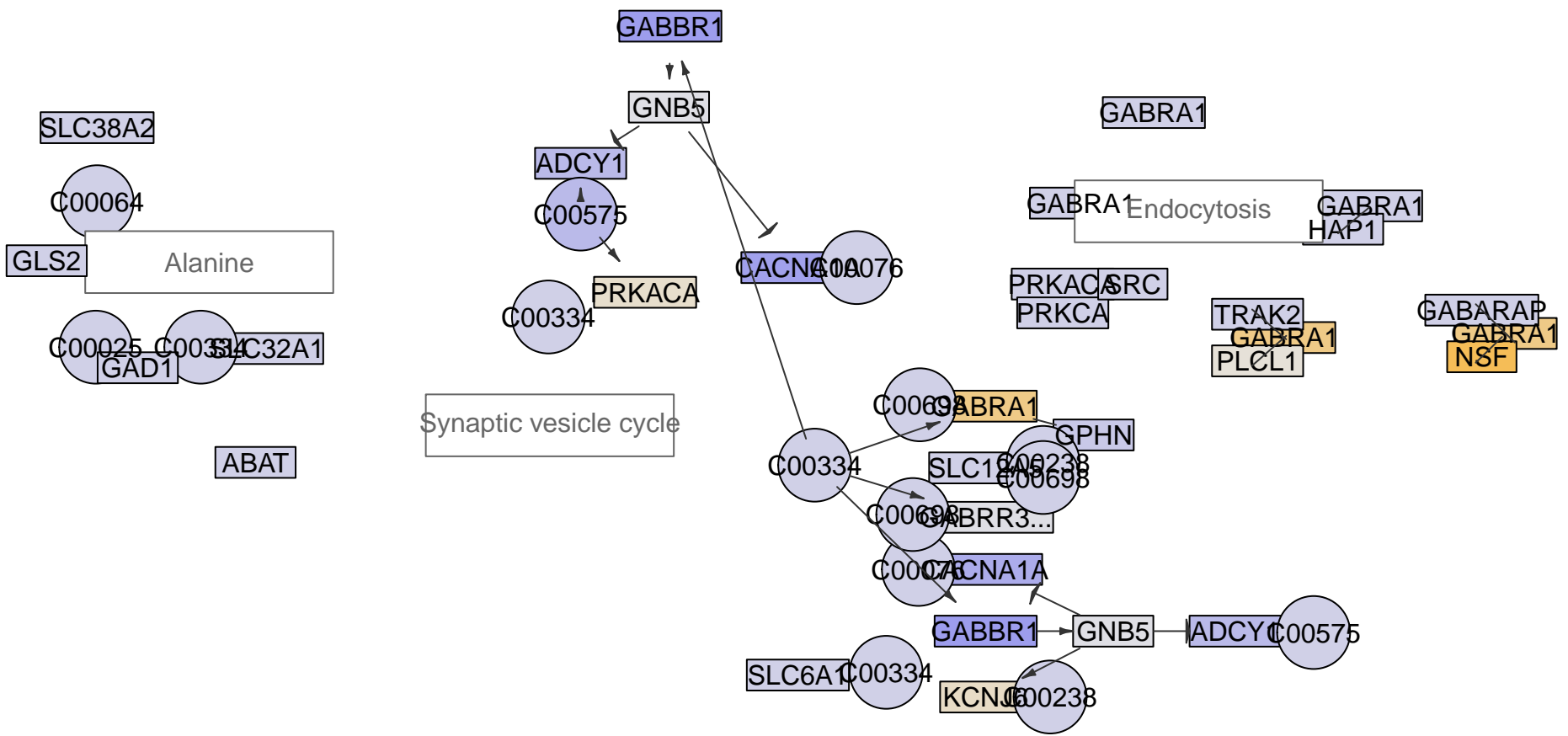

GABAergic synapse
MPI-061

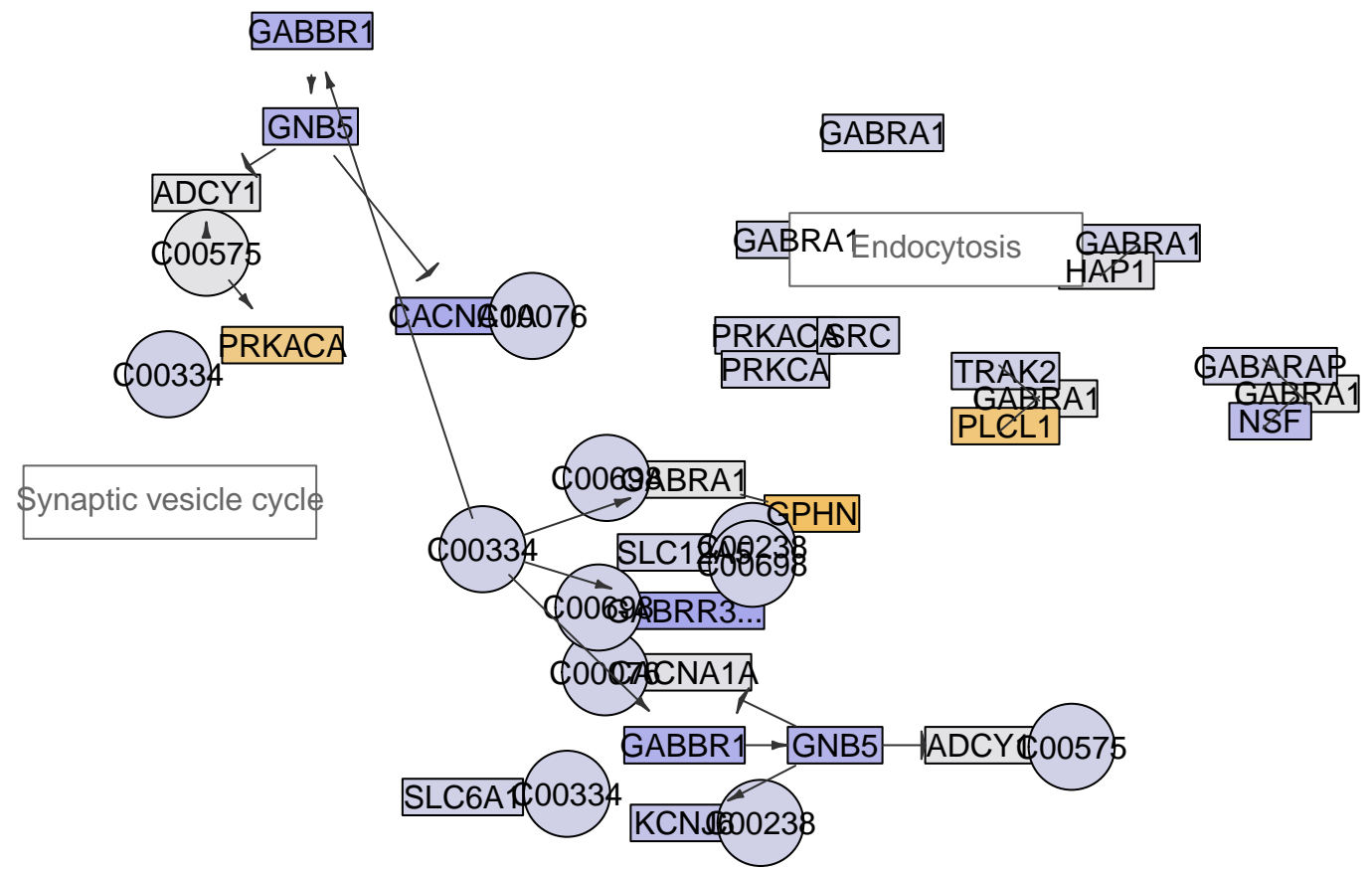
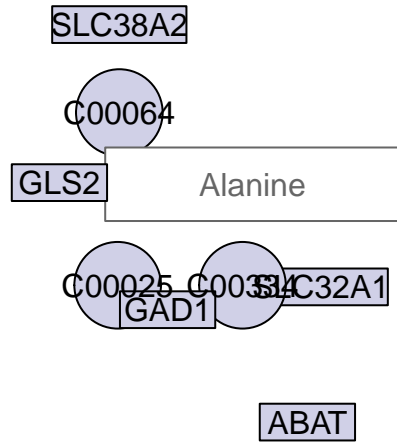

GABAergic synapse
MPI-064

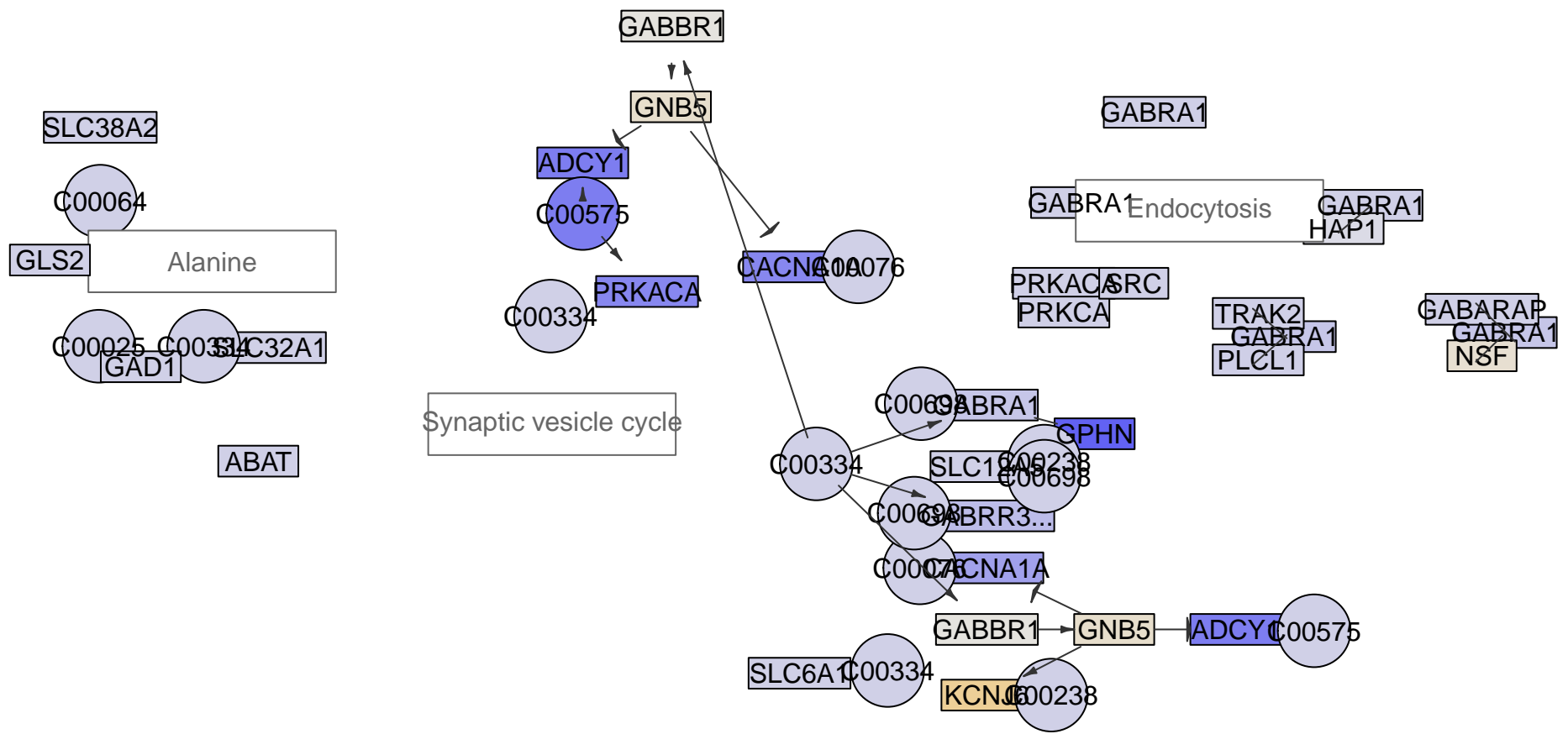

GABAergic synapse
MPI-070

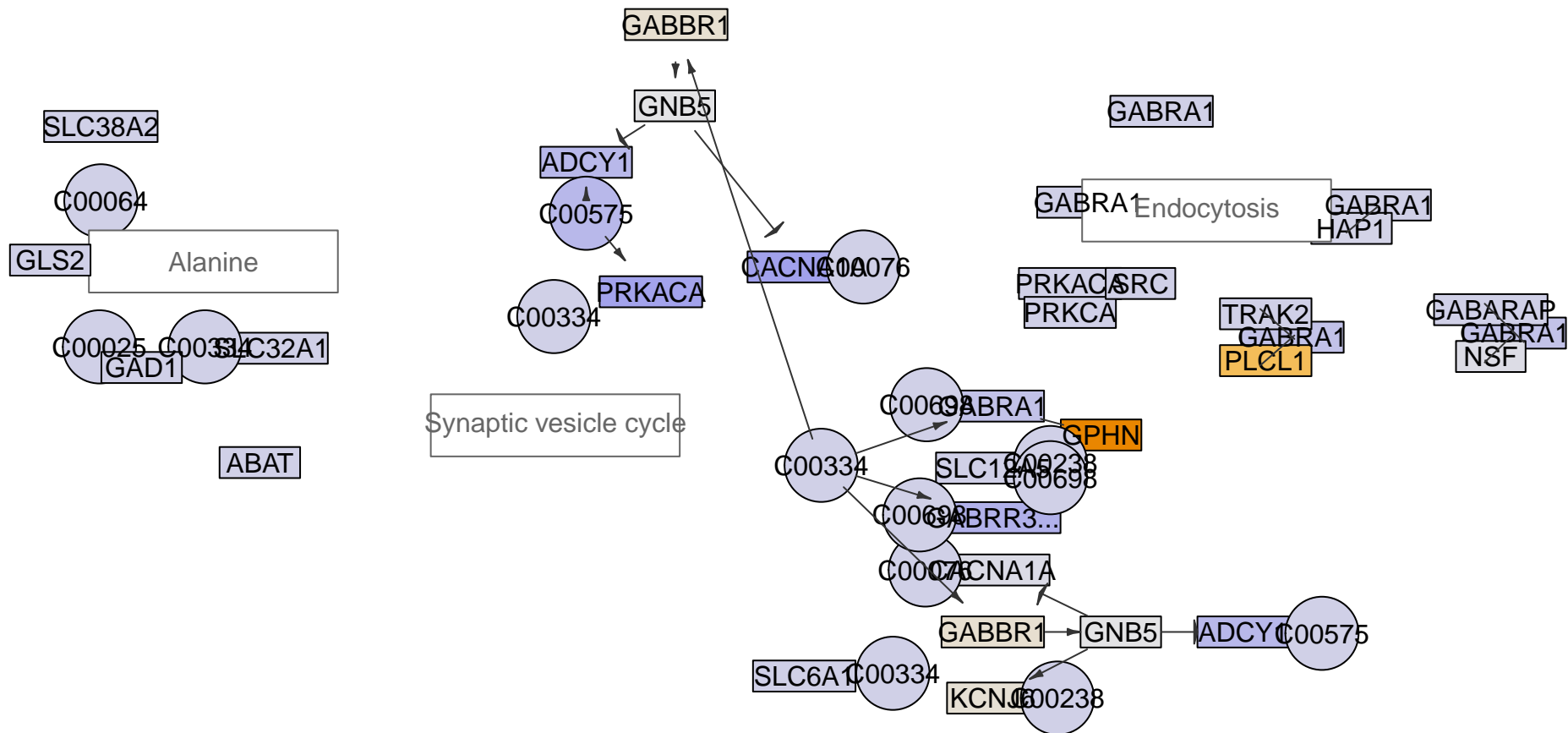

GABAergic synapse
MPI-072

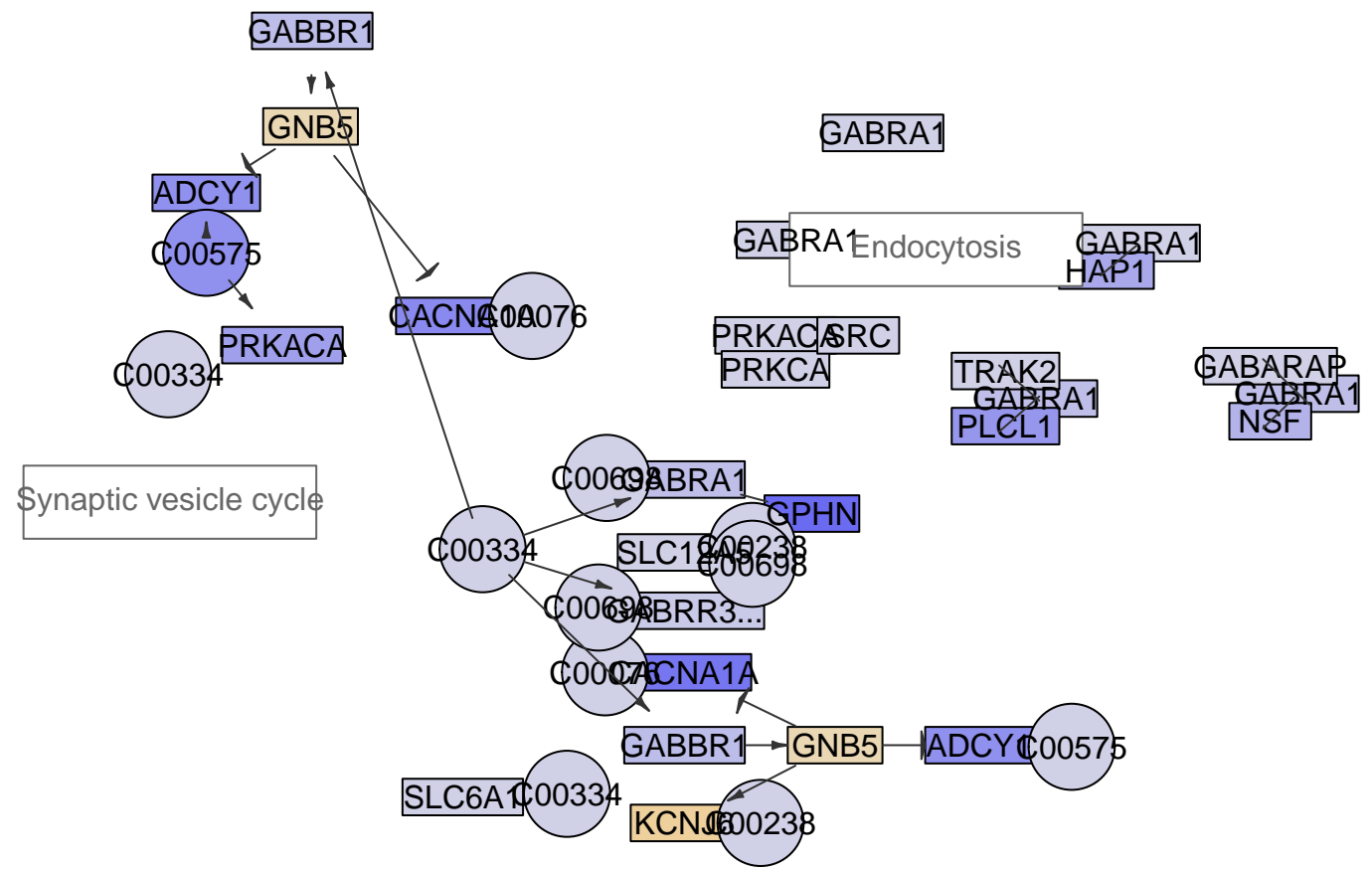
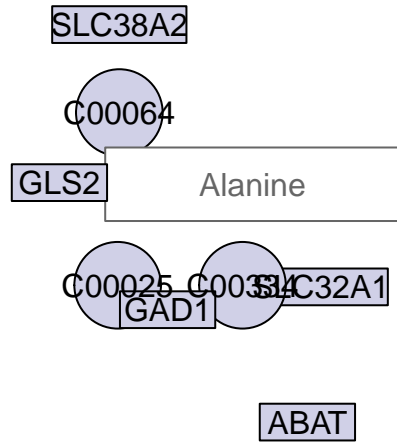

GABAergic synapse
MPI-093

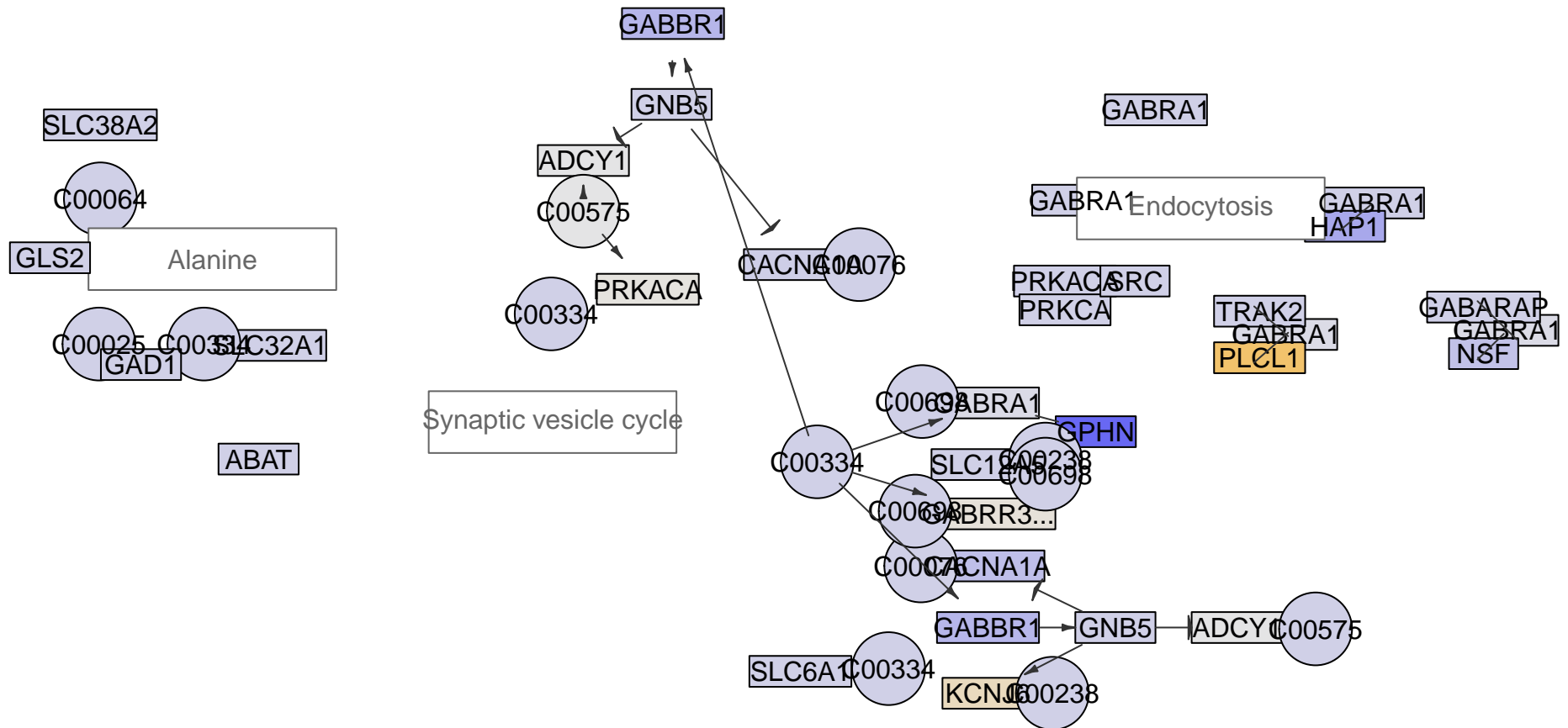

GABAergic synapse
MPI-094

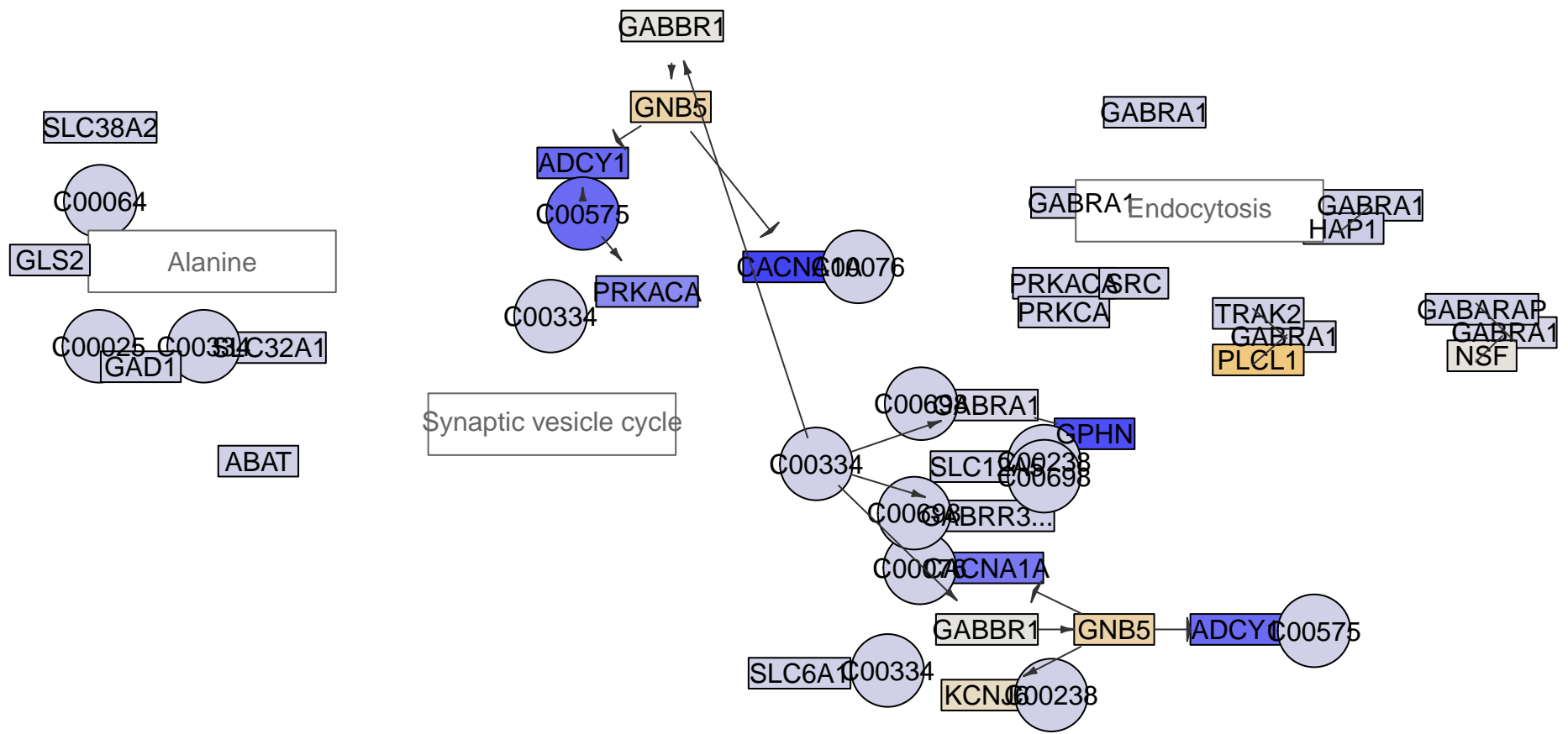

GABAergic synapse
MPI-099

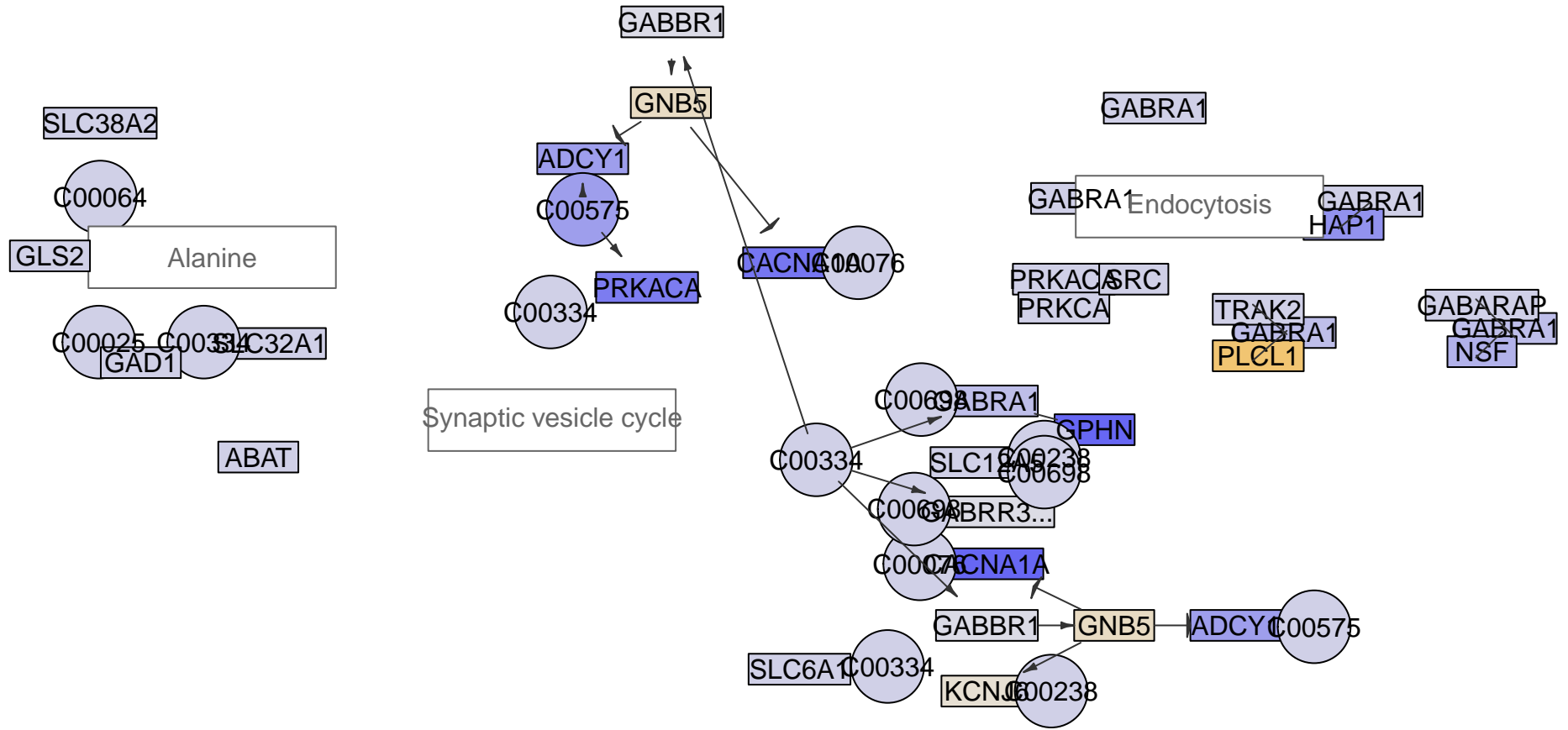

**GABAergic synapse
MPI-104**

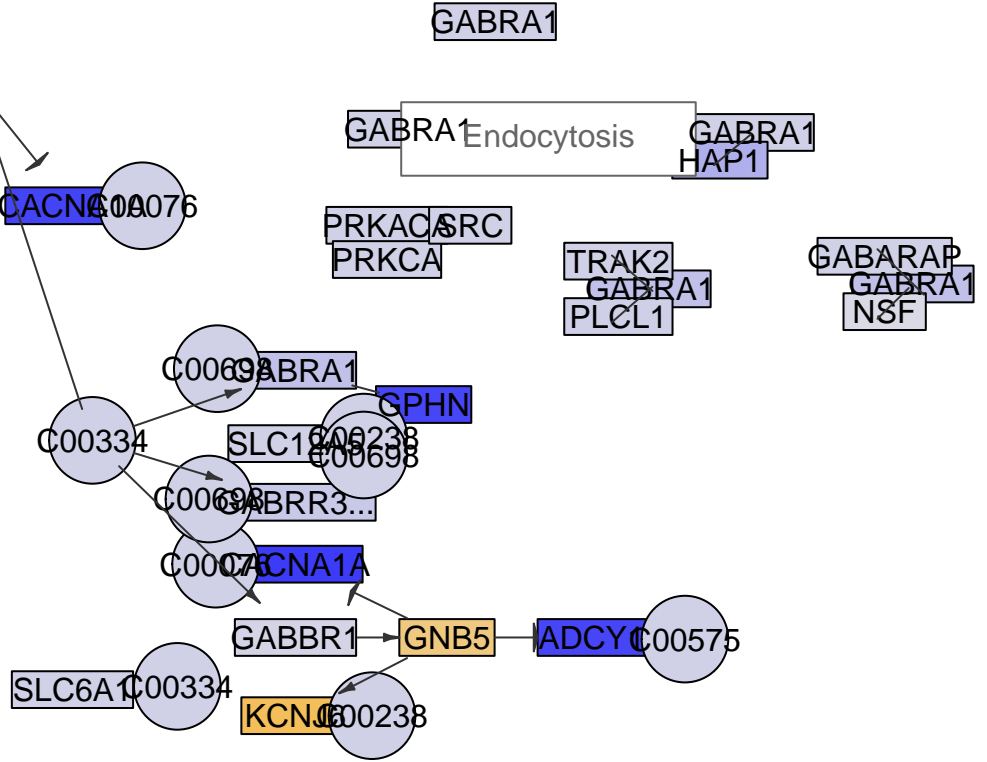
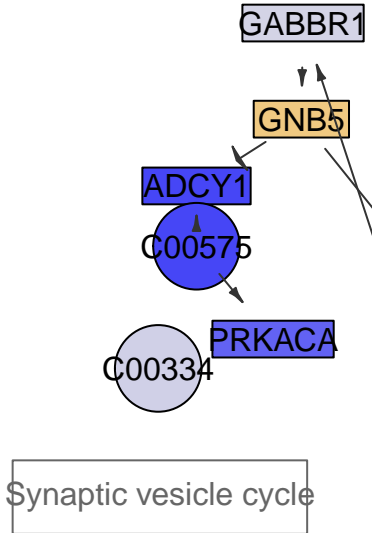
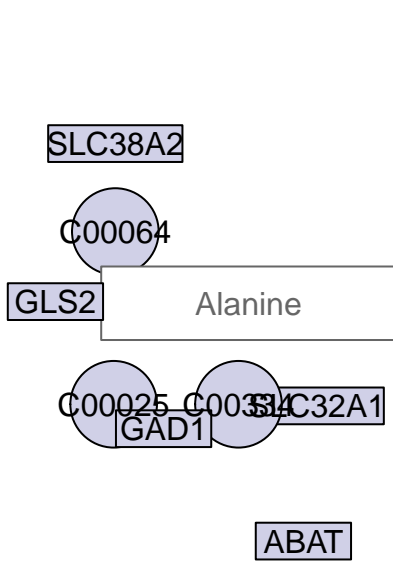

GABAergic synapse
MPI-107

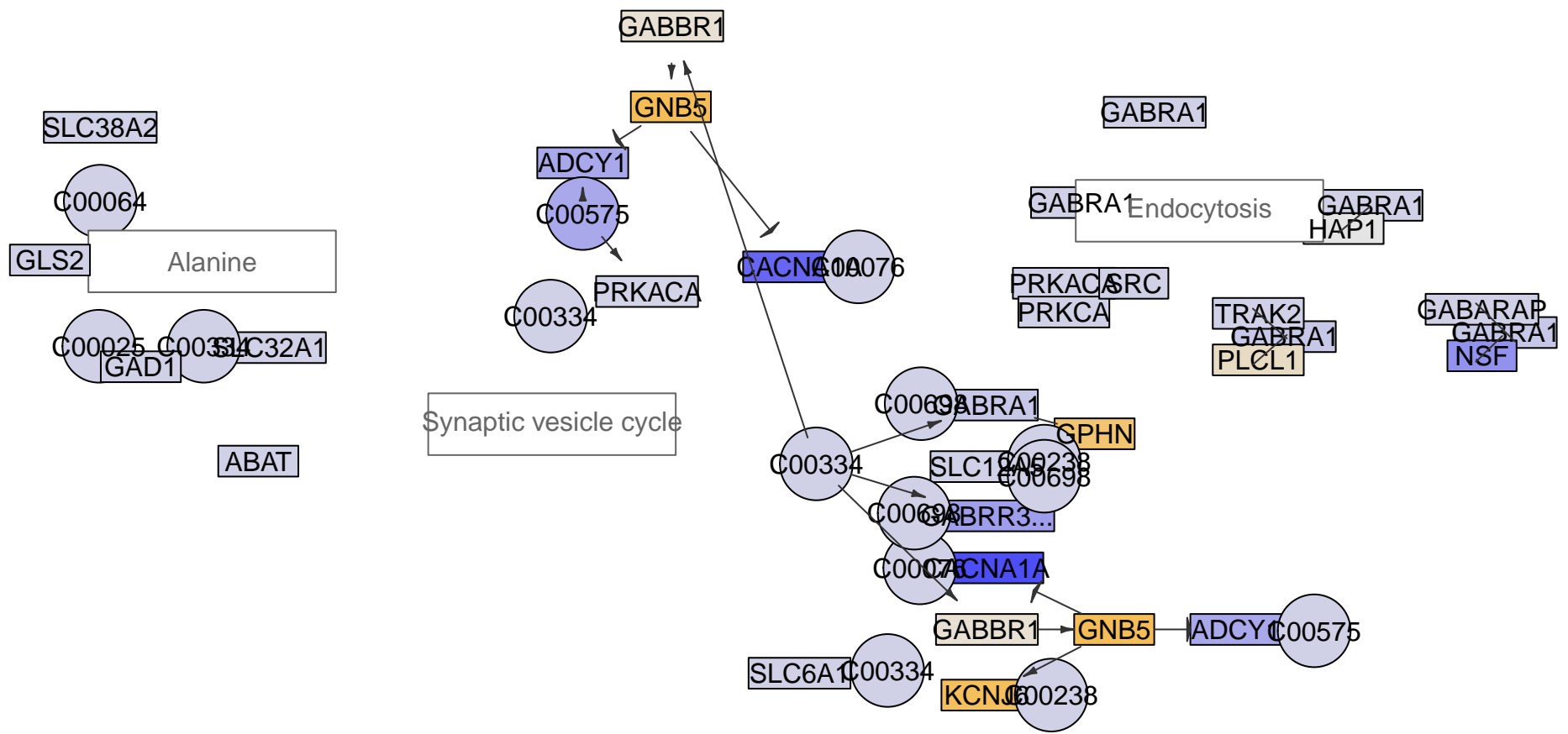

GABAergic synapse
MPI-112

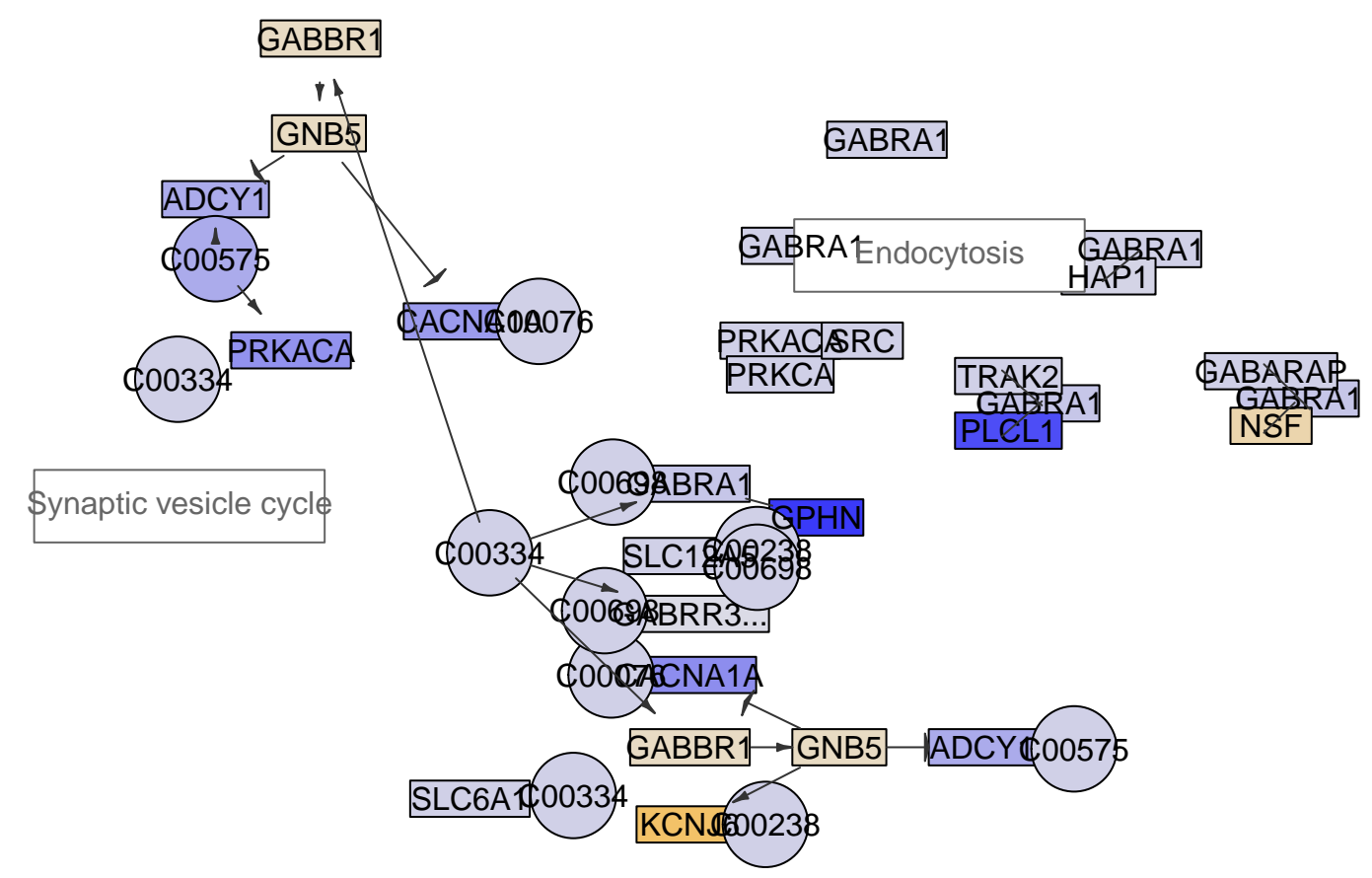
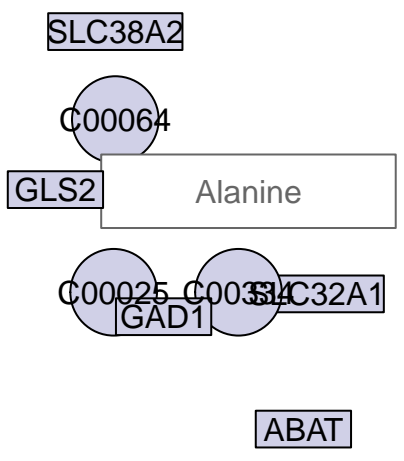

GABAergic synapse
MPI-116

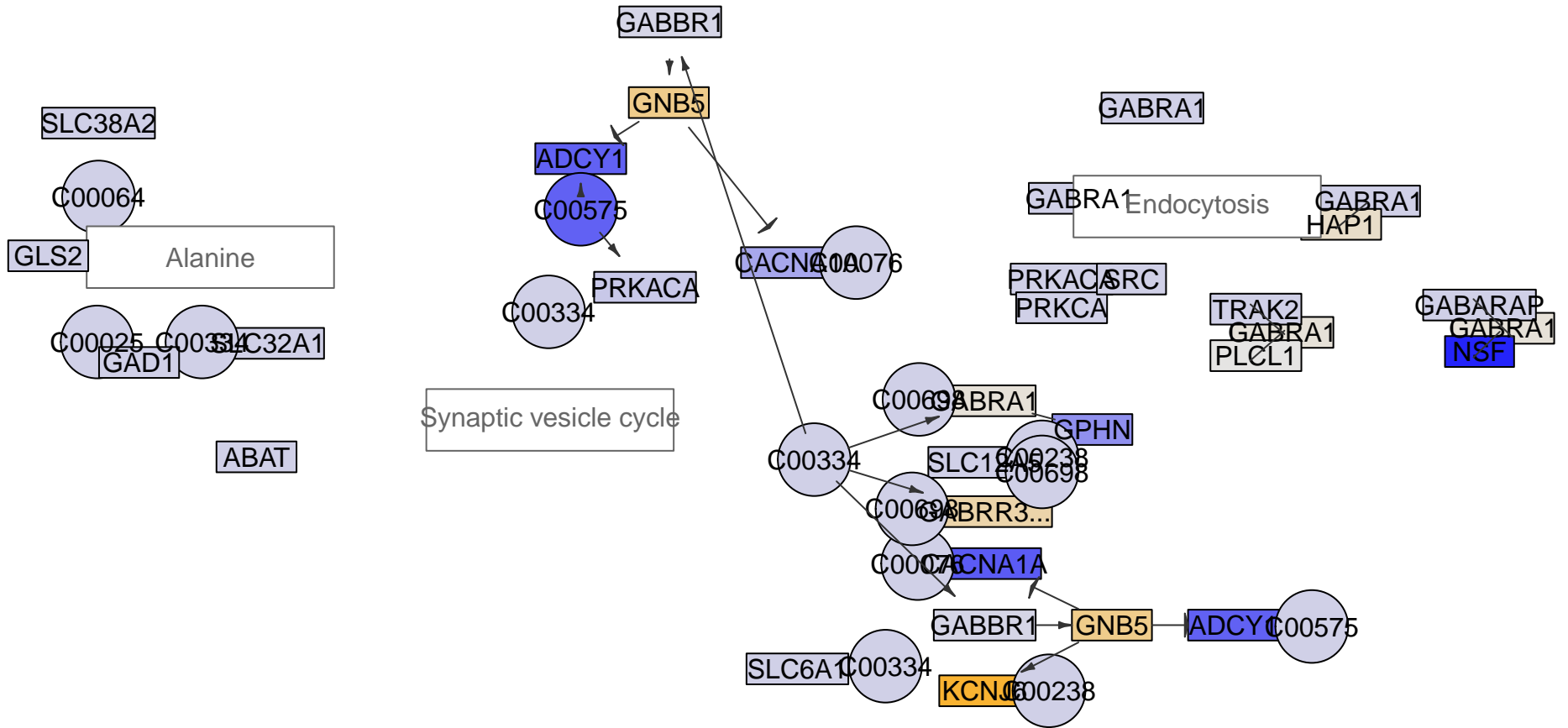
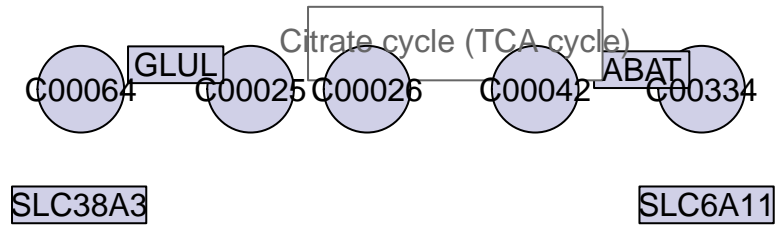

GABAergic synapse
MPI-117

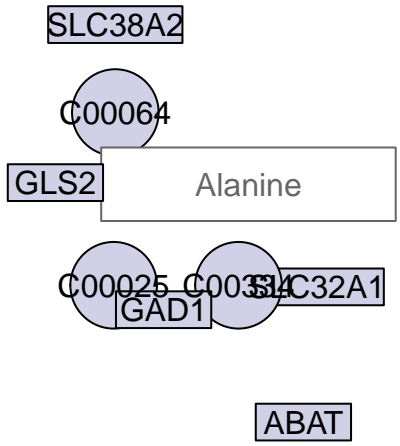
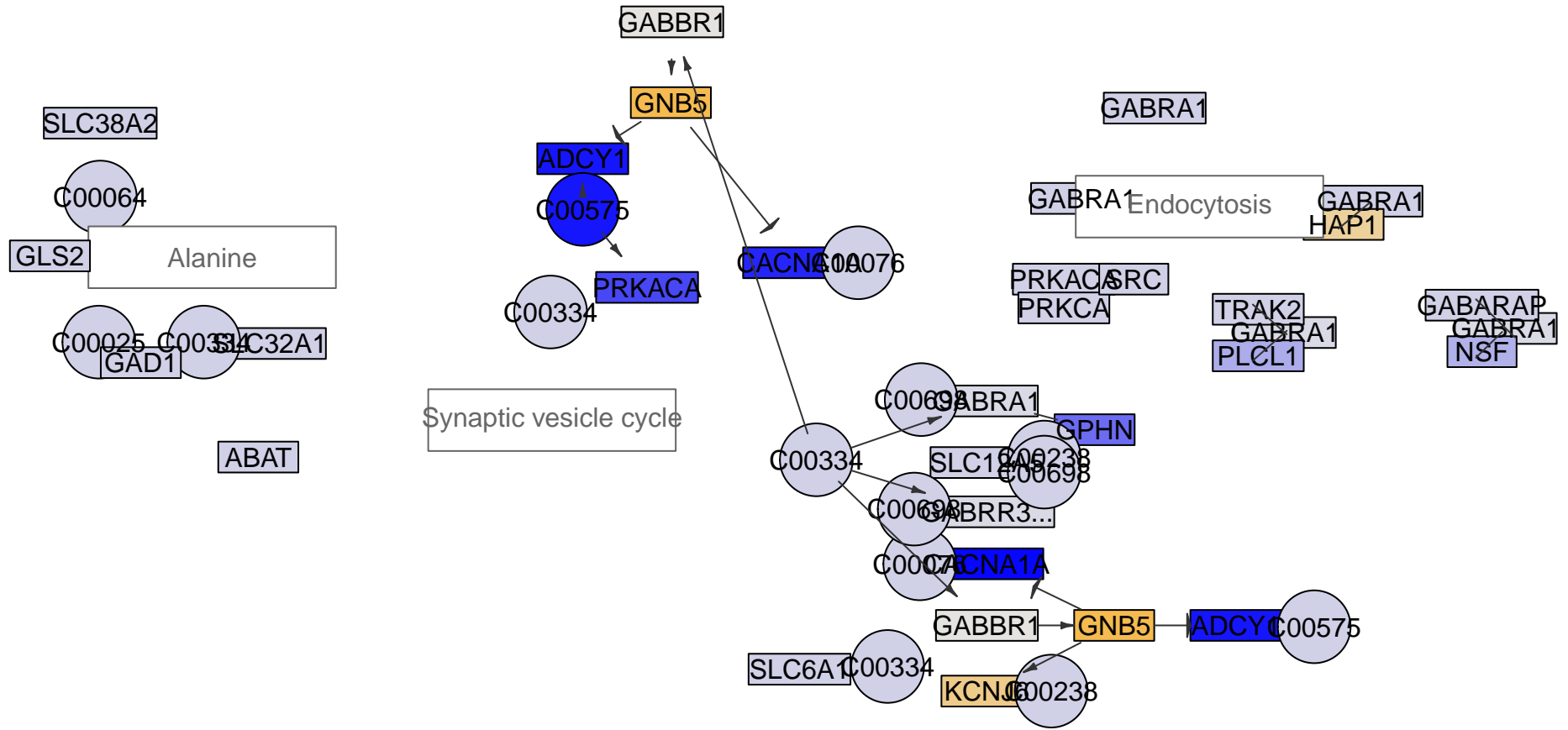
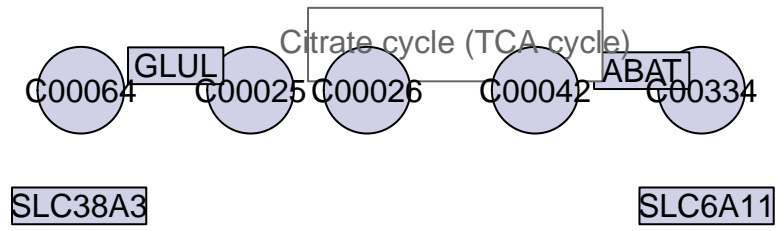

Synaptic vesicle cycle

GABAergic synapse
MPI-120

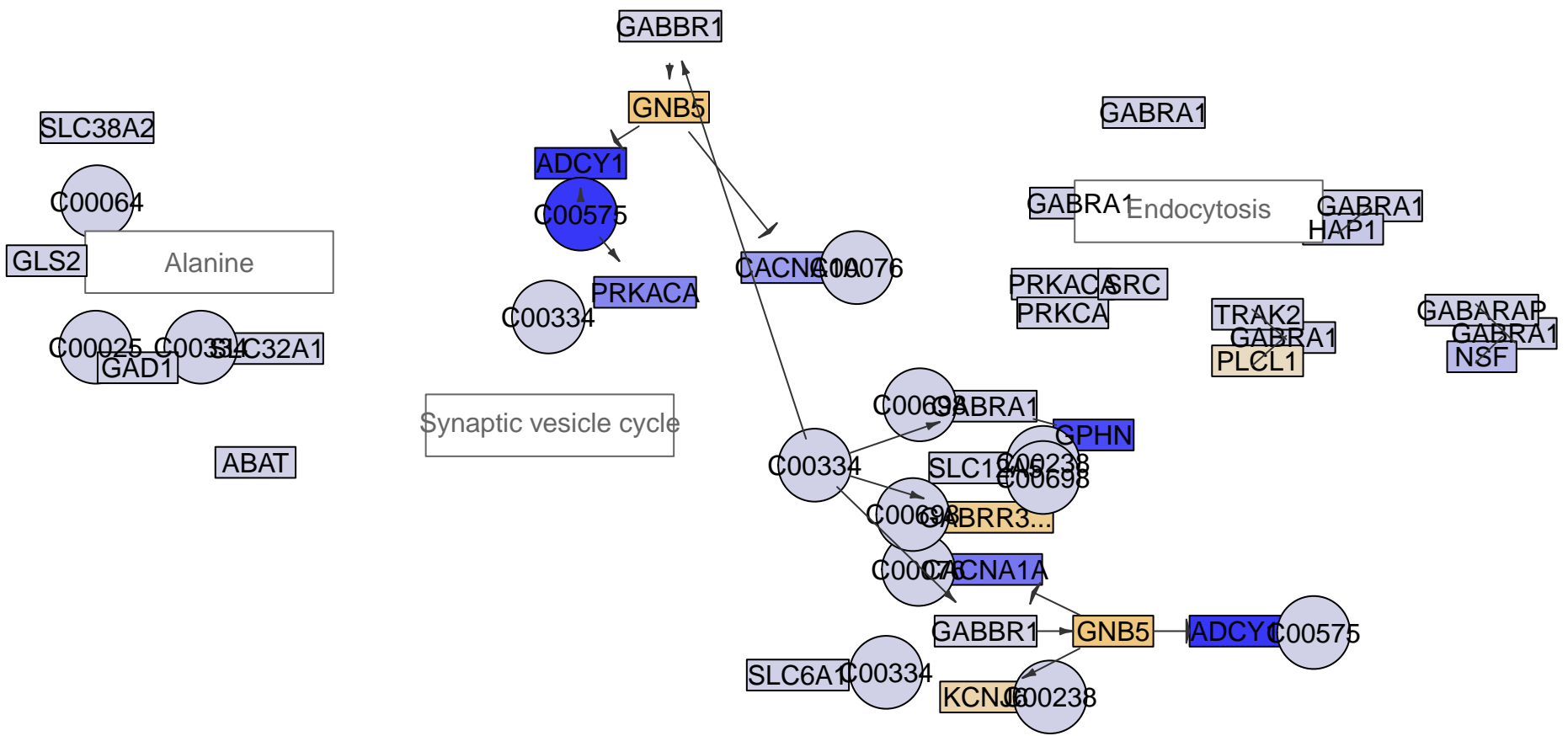

GABAergic synapse
MPI-121

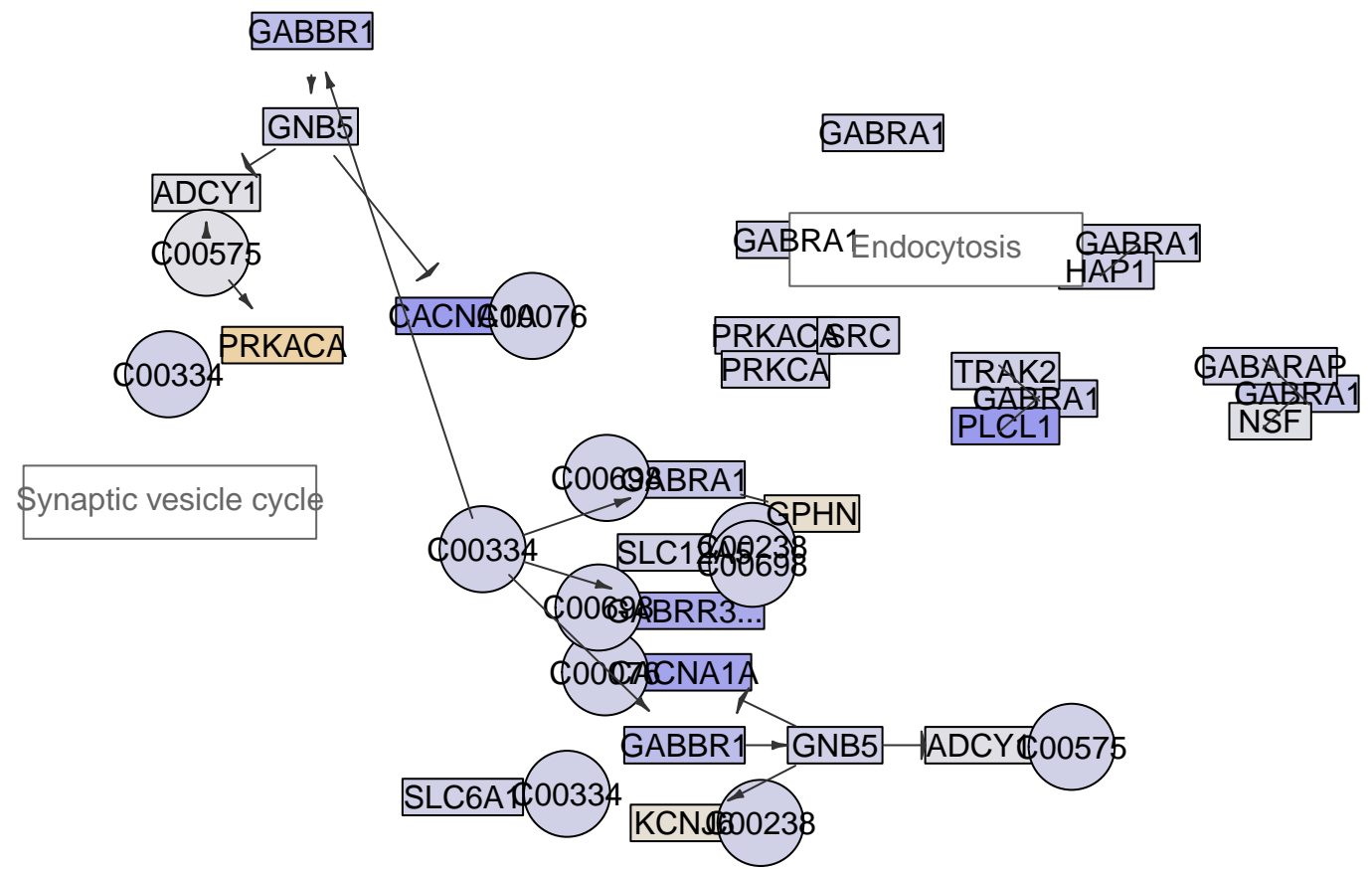
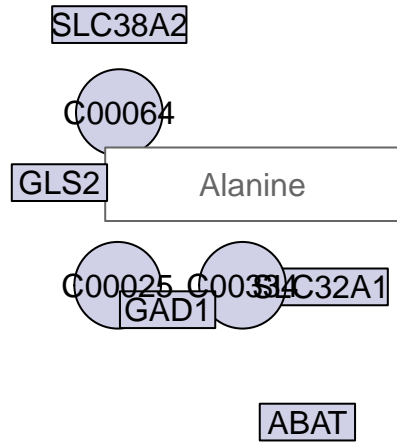

GABAergic synapse
MPI-124

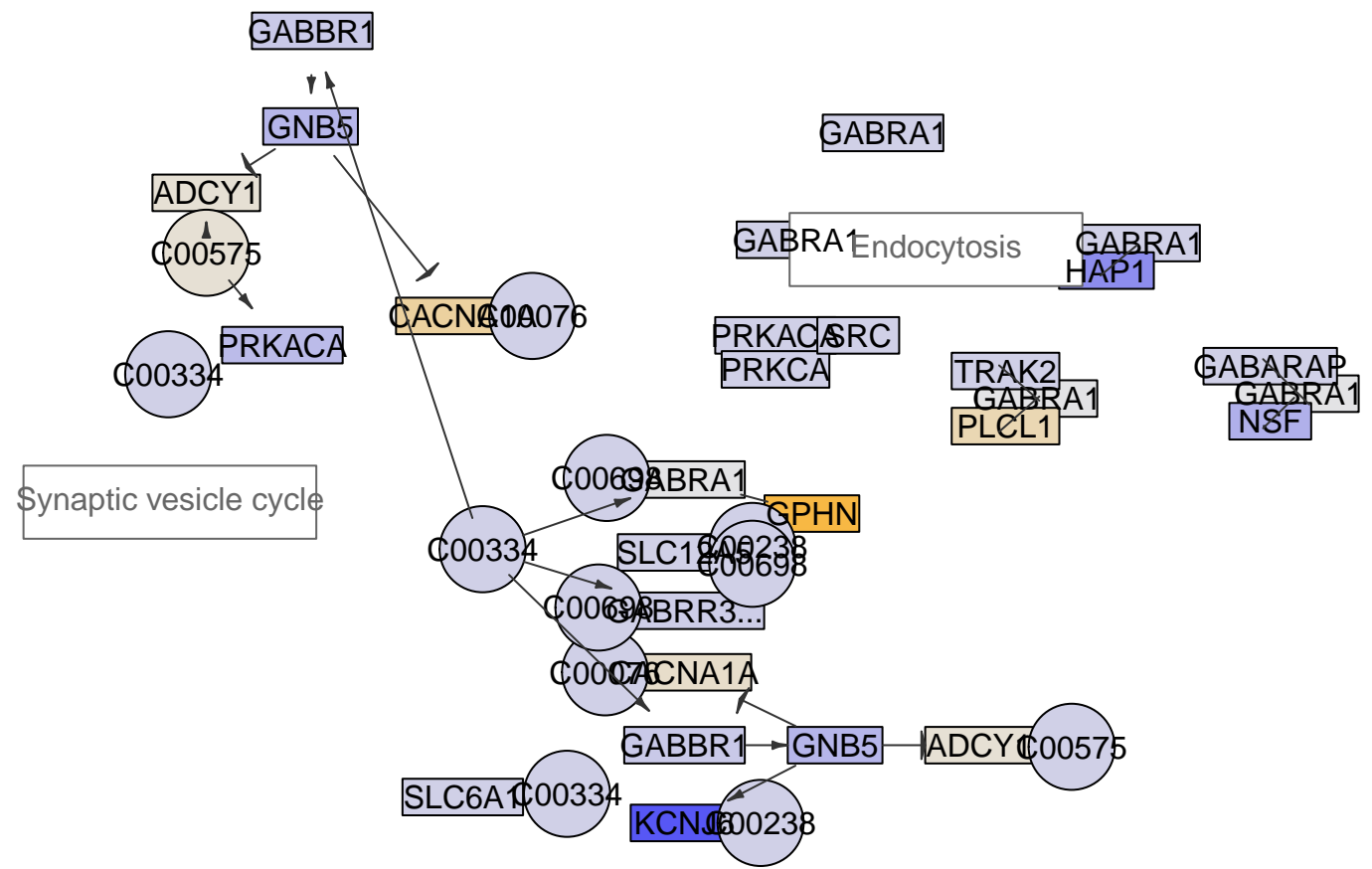
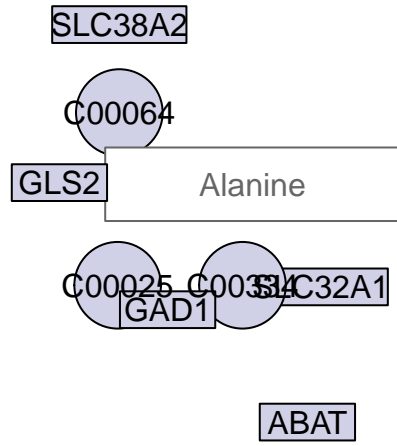

GABAergic synapse
MPI-126

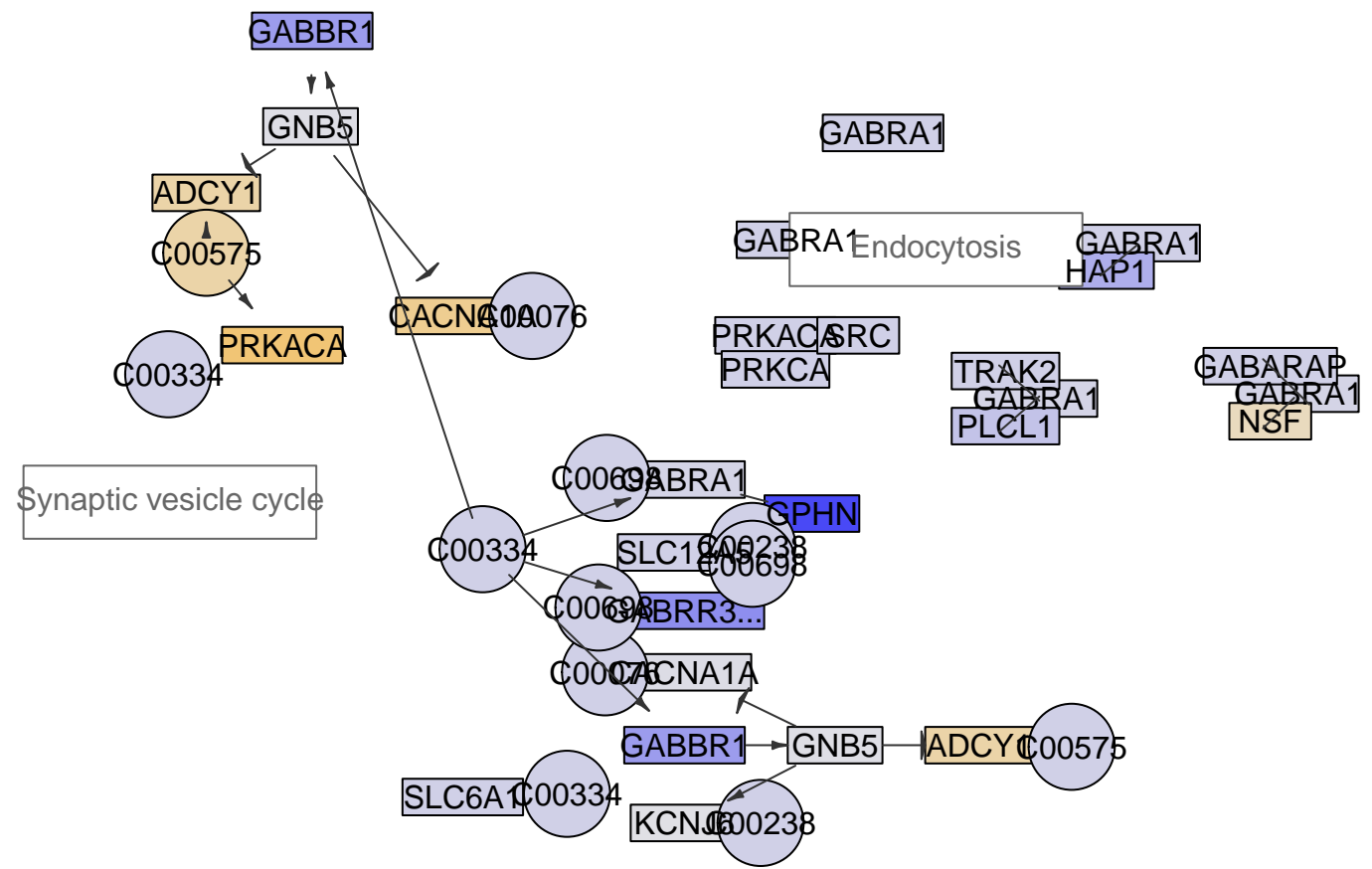
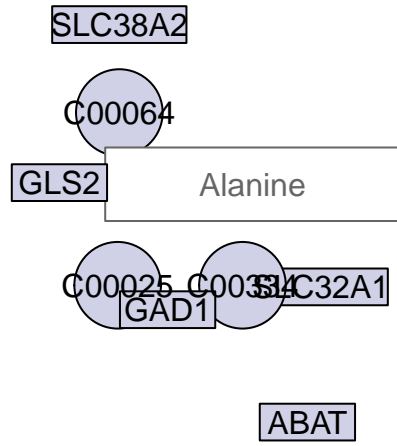

GABAergic synapse
MPI-131

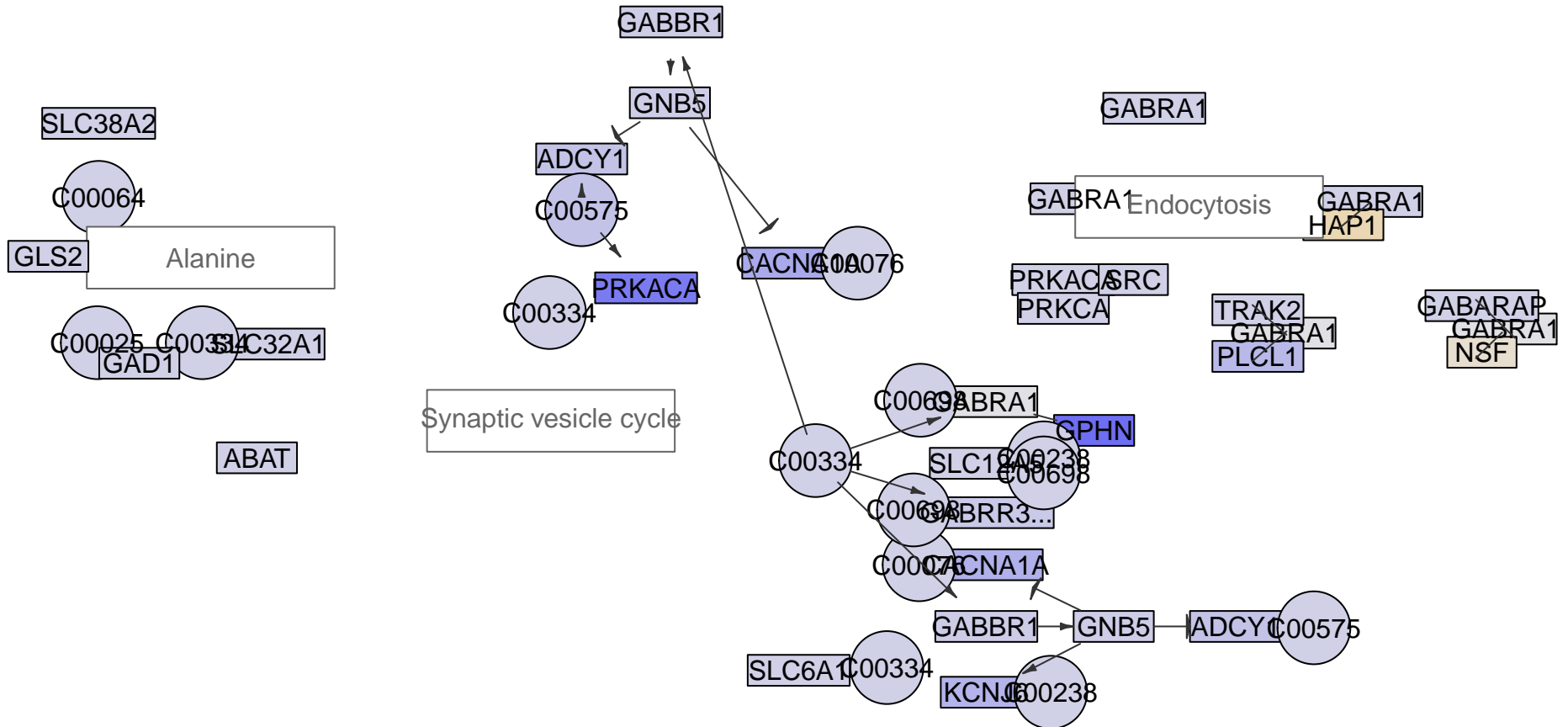
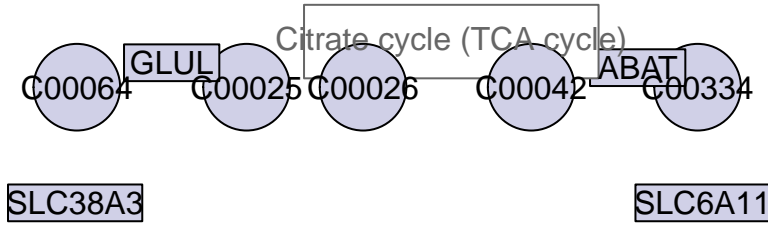

GABAergic synapse
MPI-143

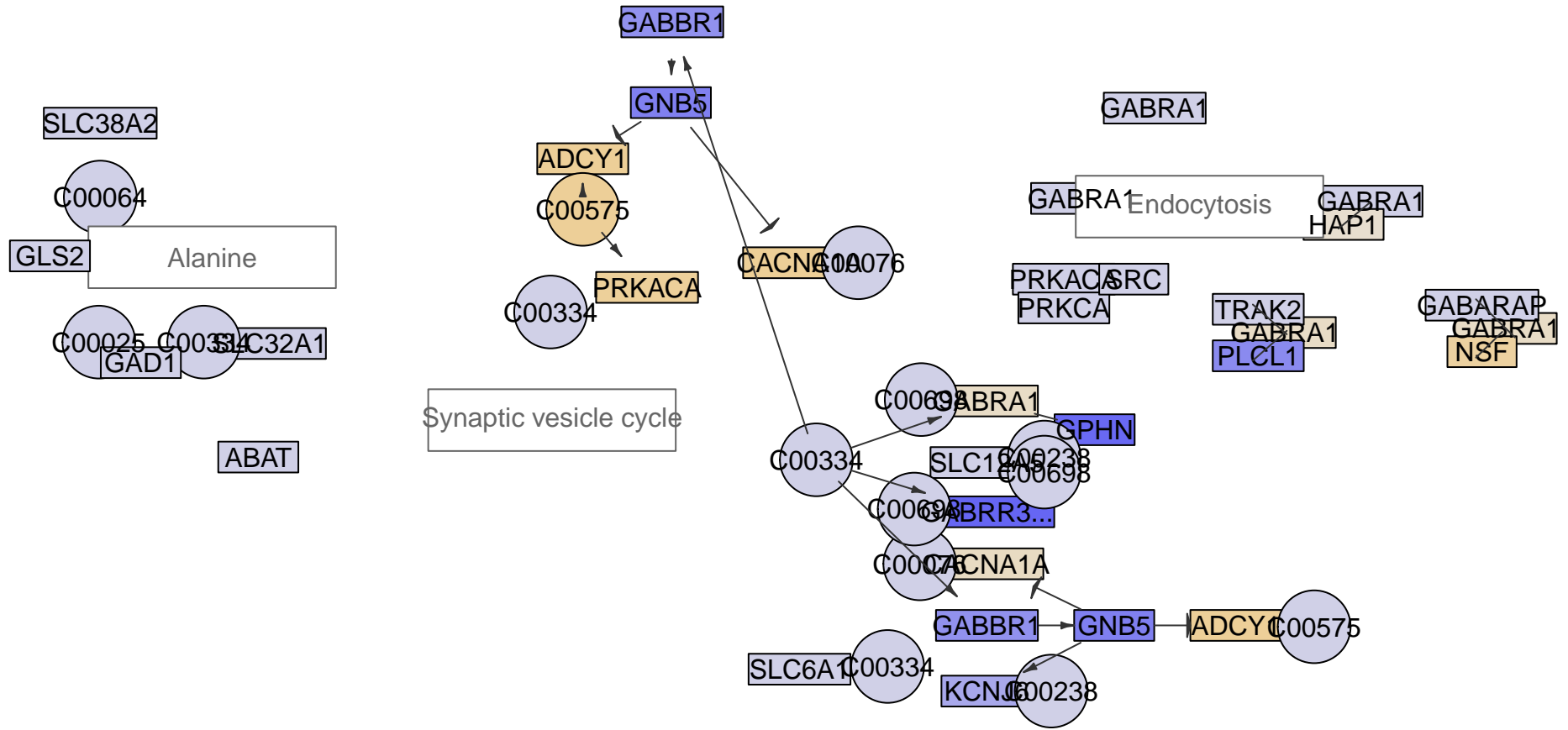

GABAergic synapse
MPI-148

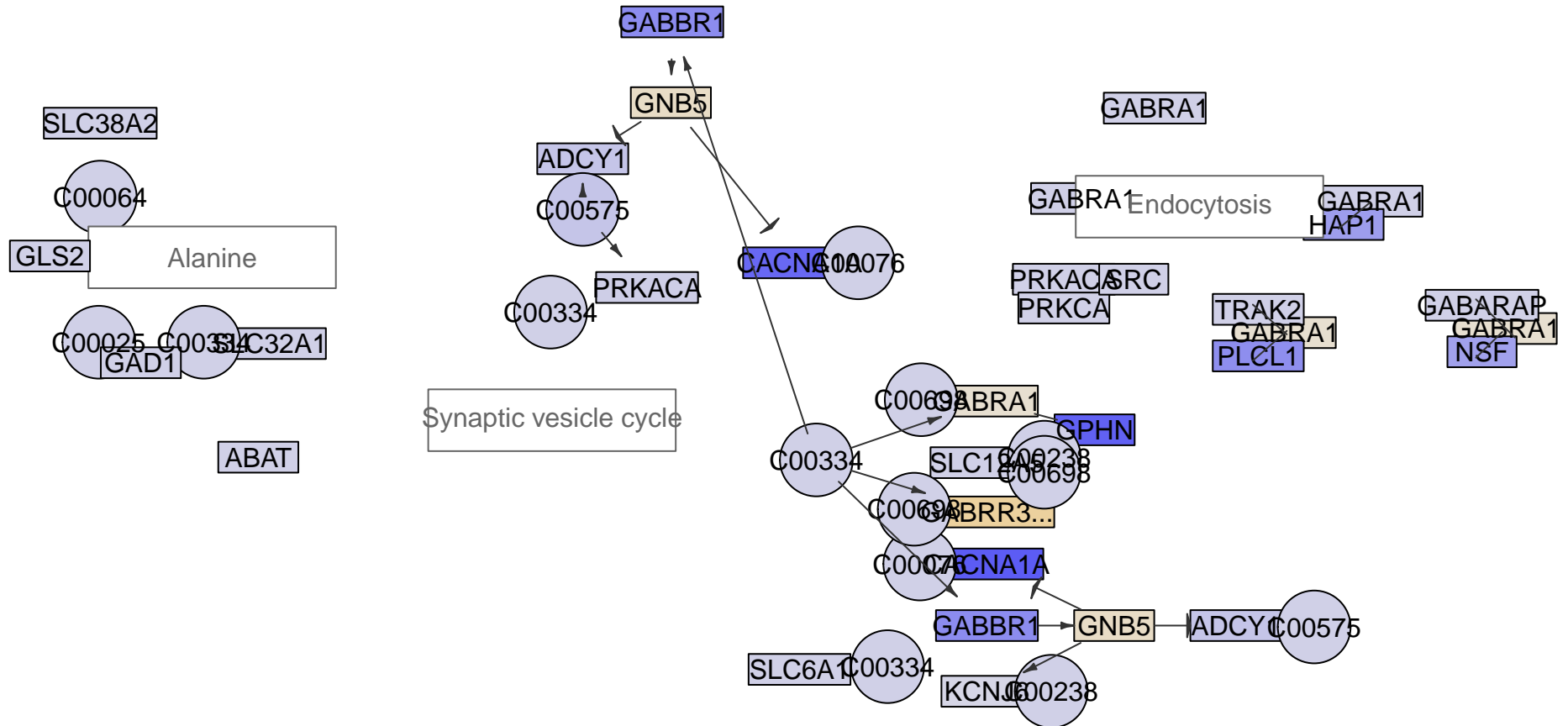
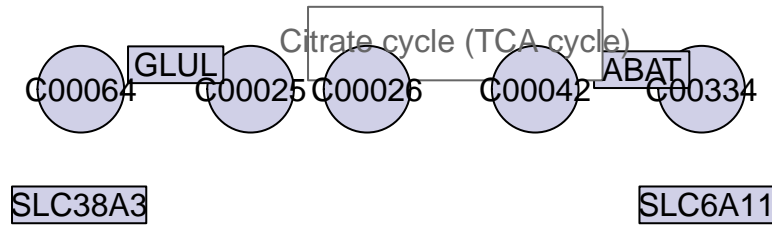

GABAergic synapse
MPI-161

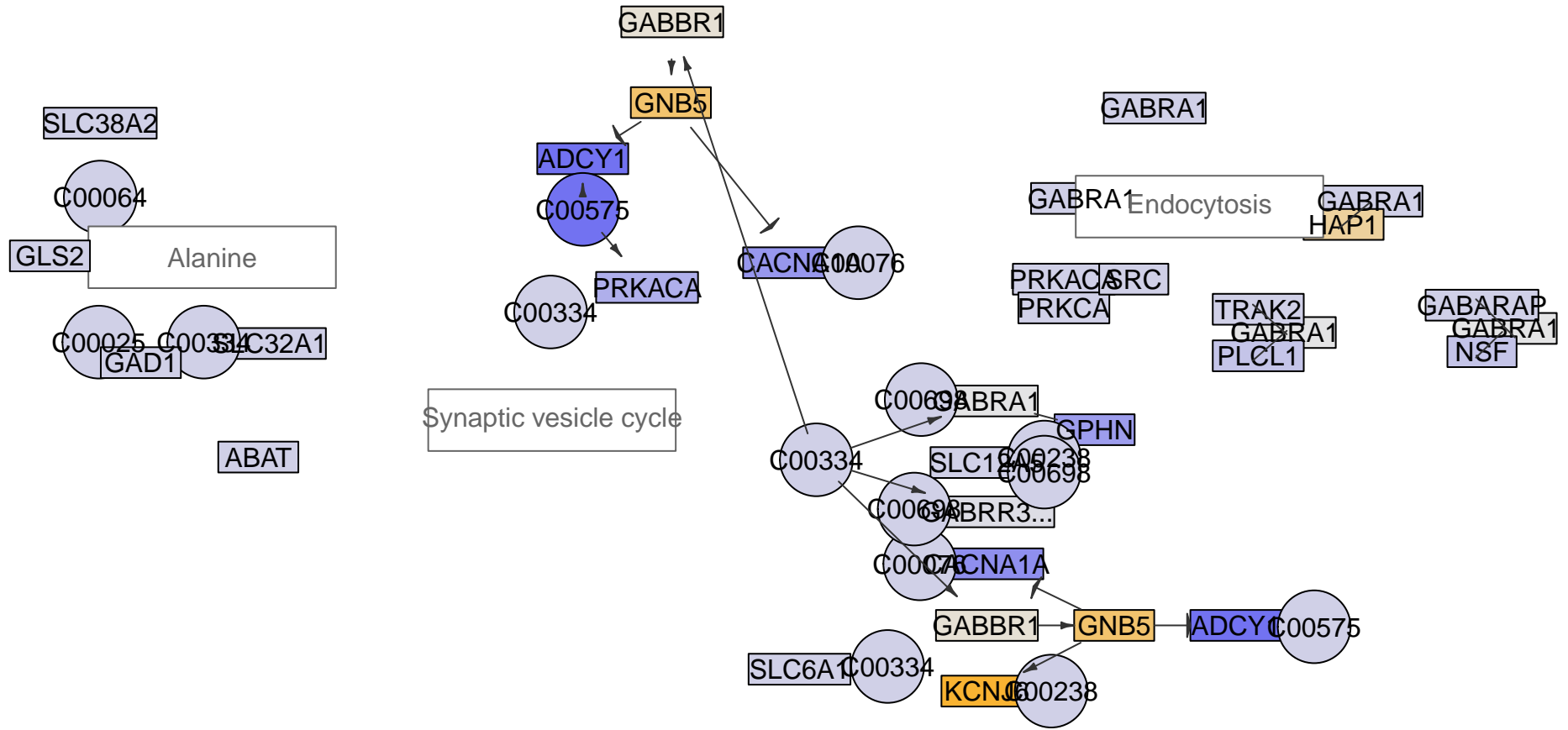

GABAergic synapse
MPI-162

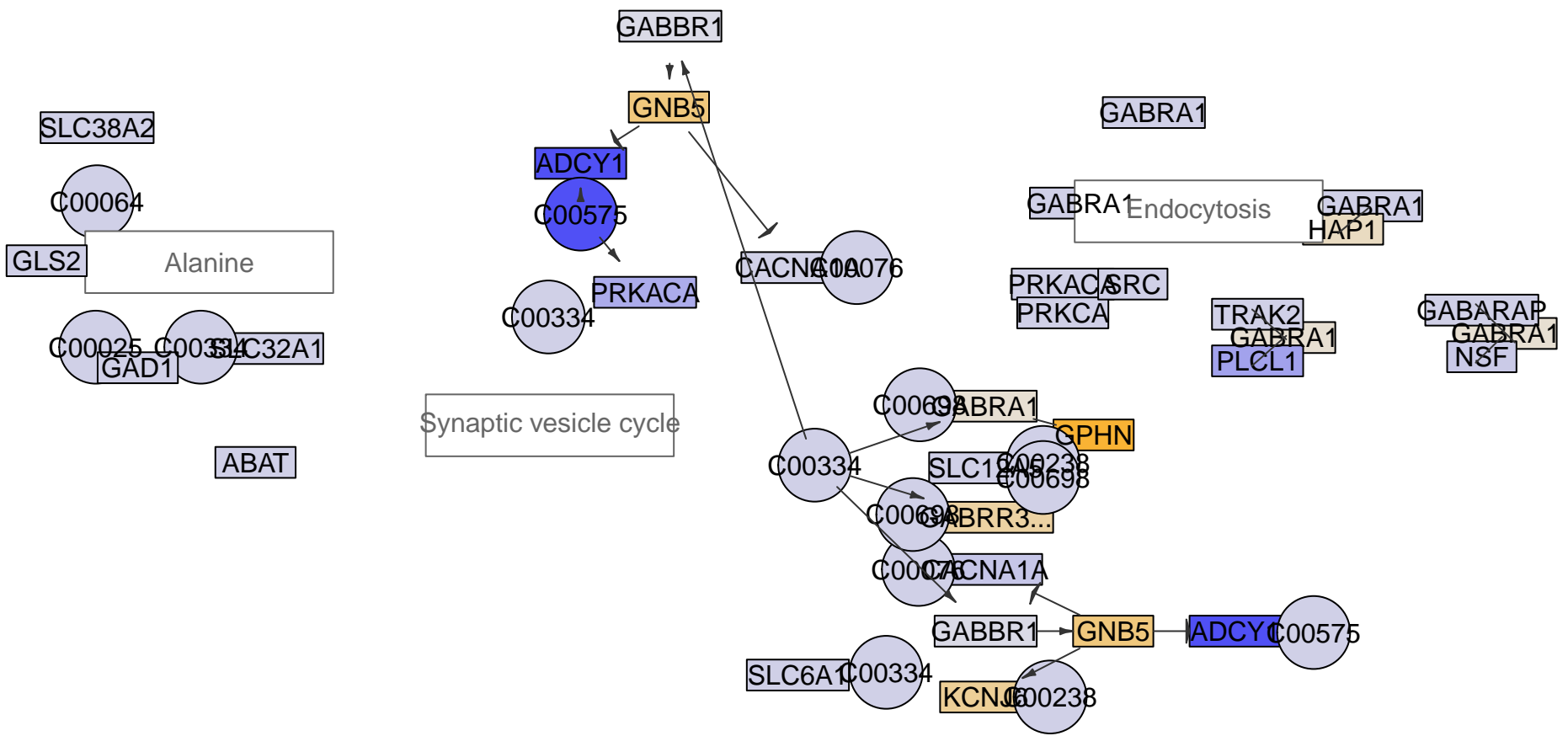

GABAergic synapse
MPI-165

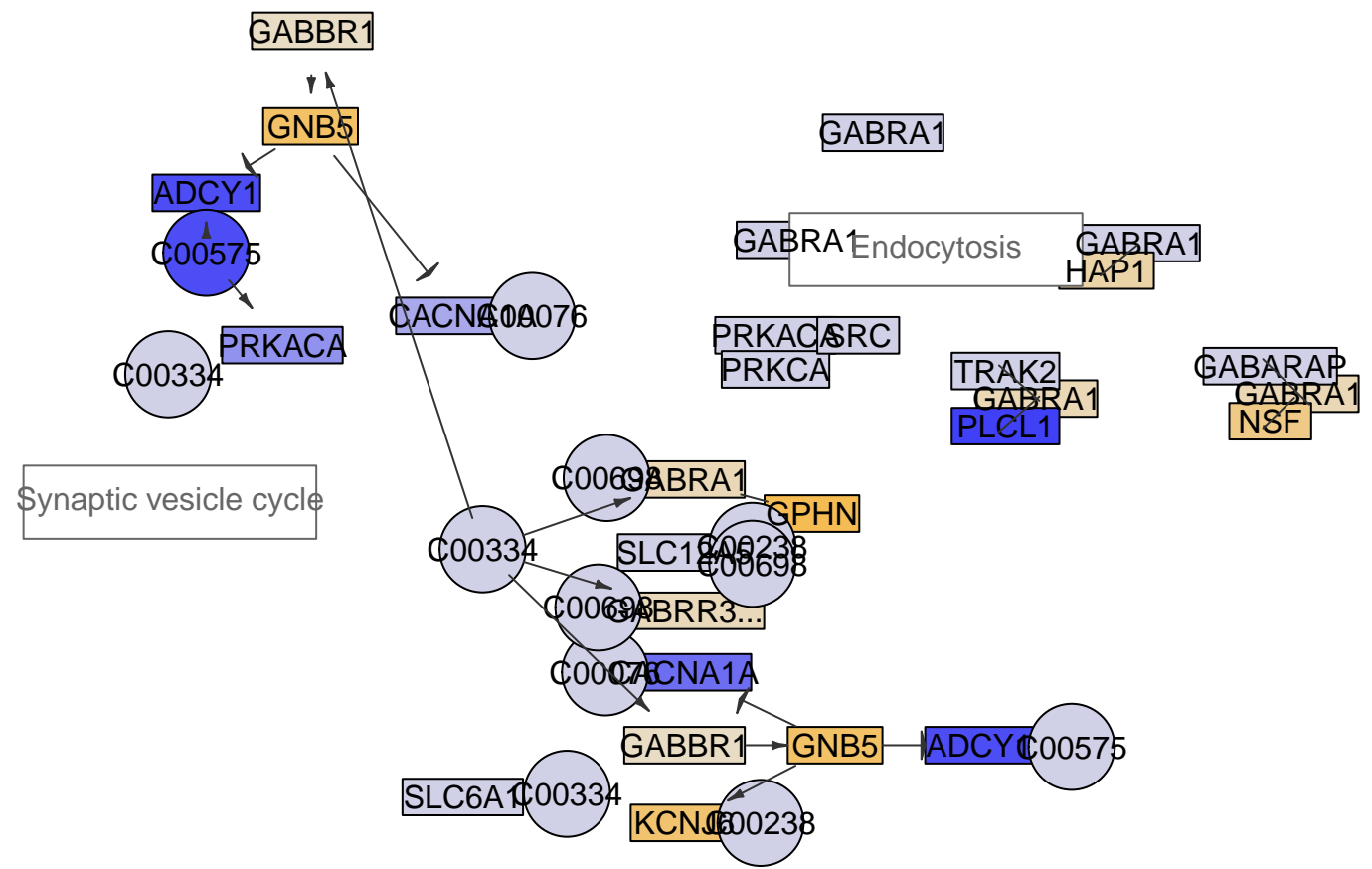
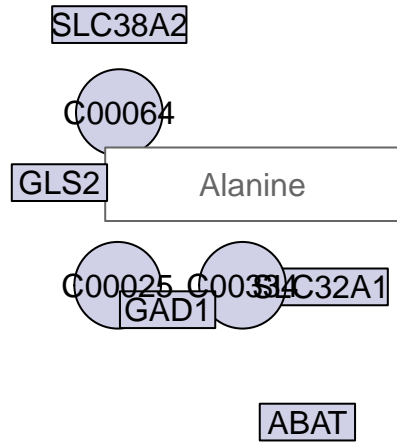

GABAergic synapse
MPI-169

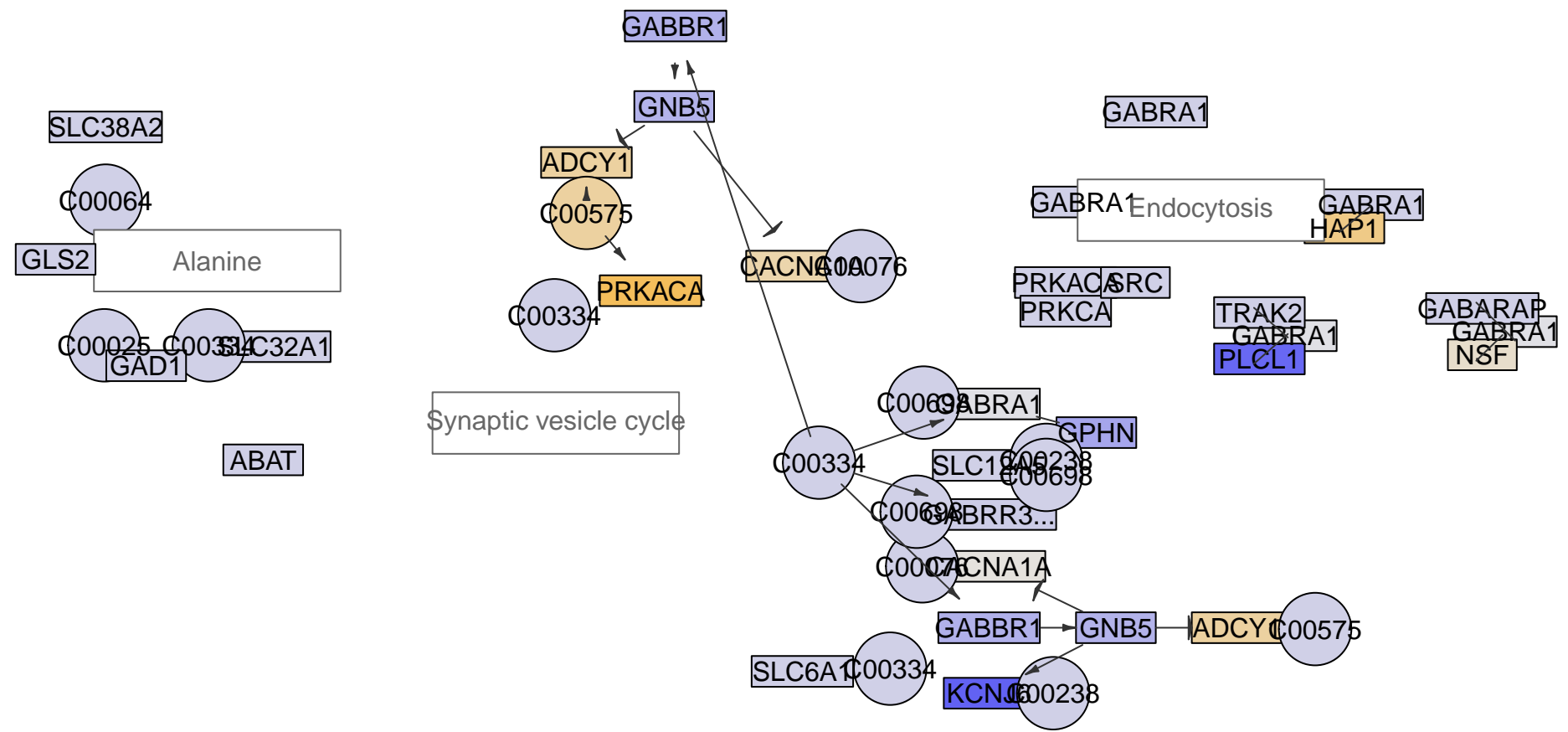

GABAergic synapse
MPI-175

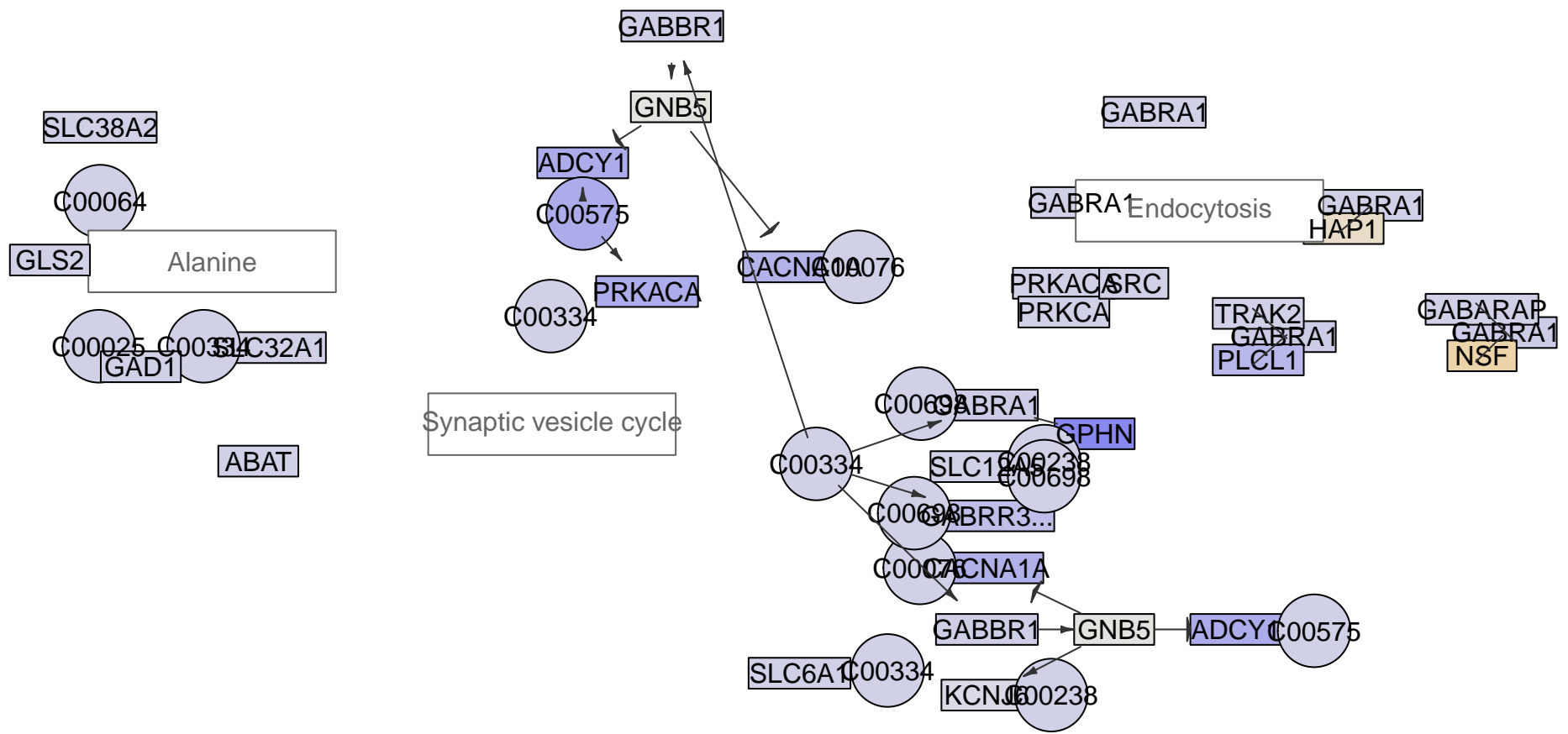

GABAergic synapse
MPI-187

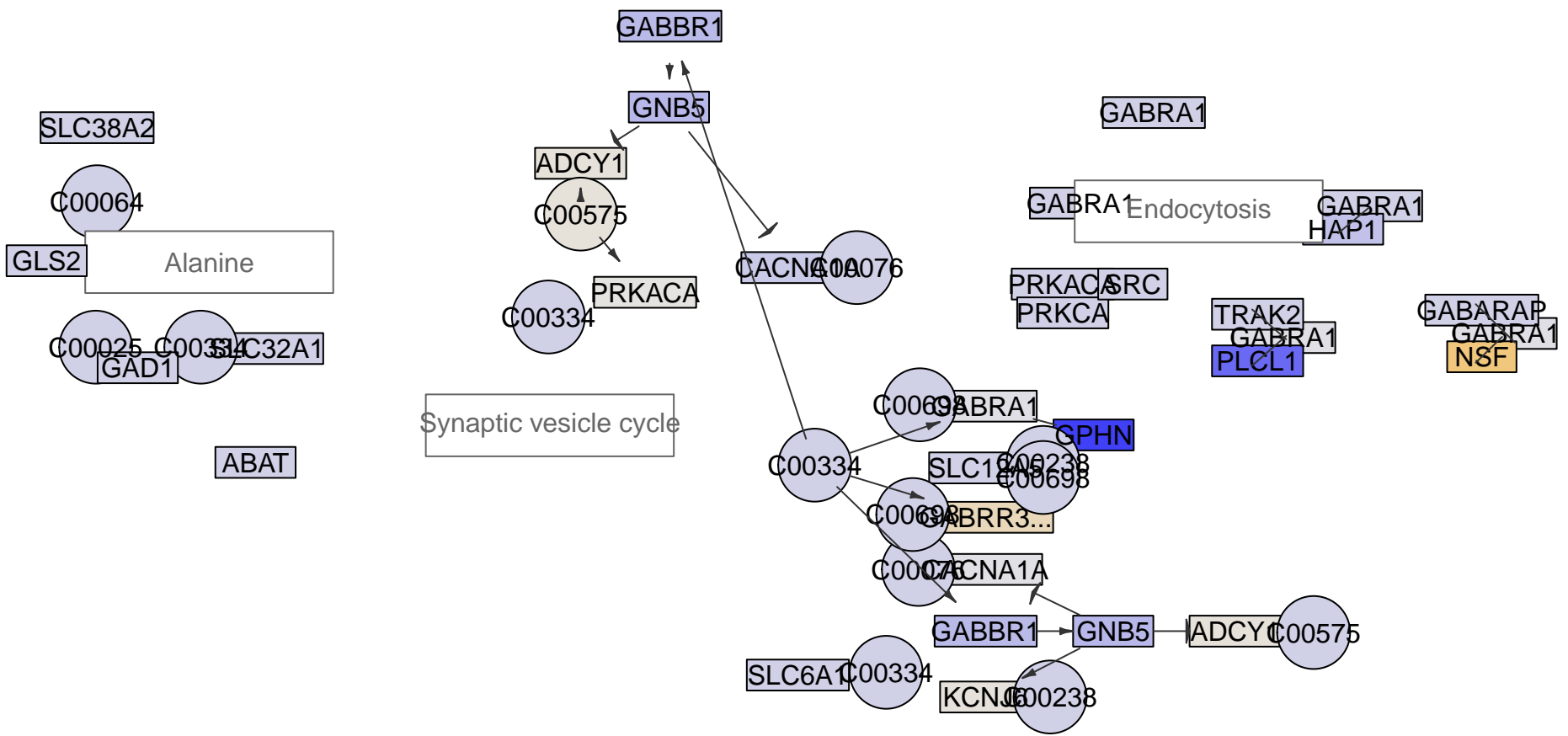

GABAergic synapse
MPI-193

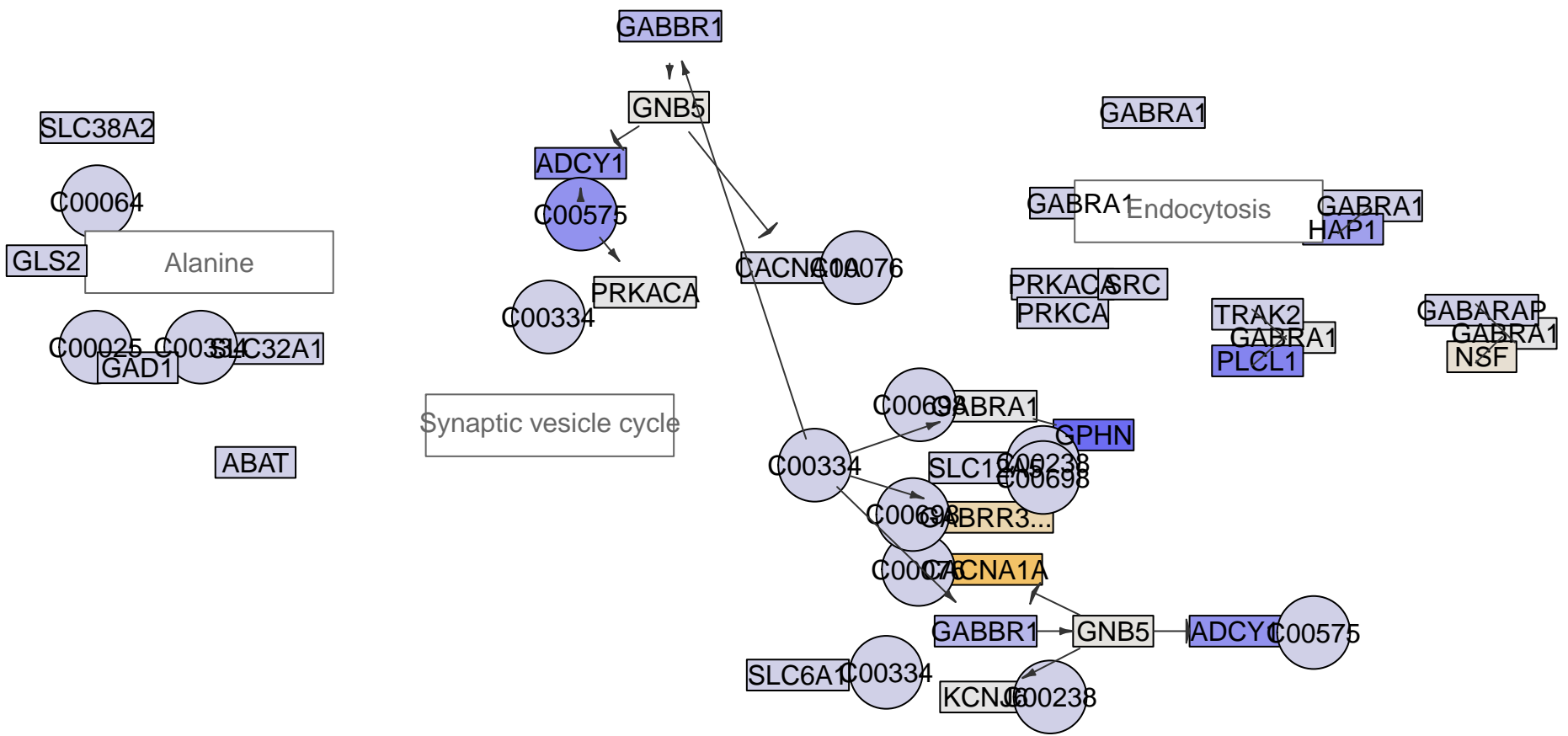

GABAergic synapse
MPI-216

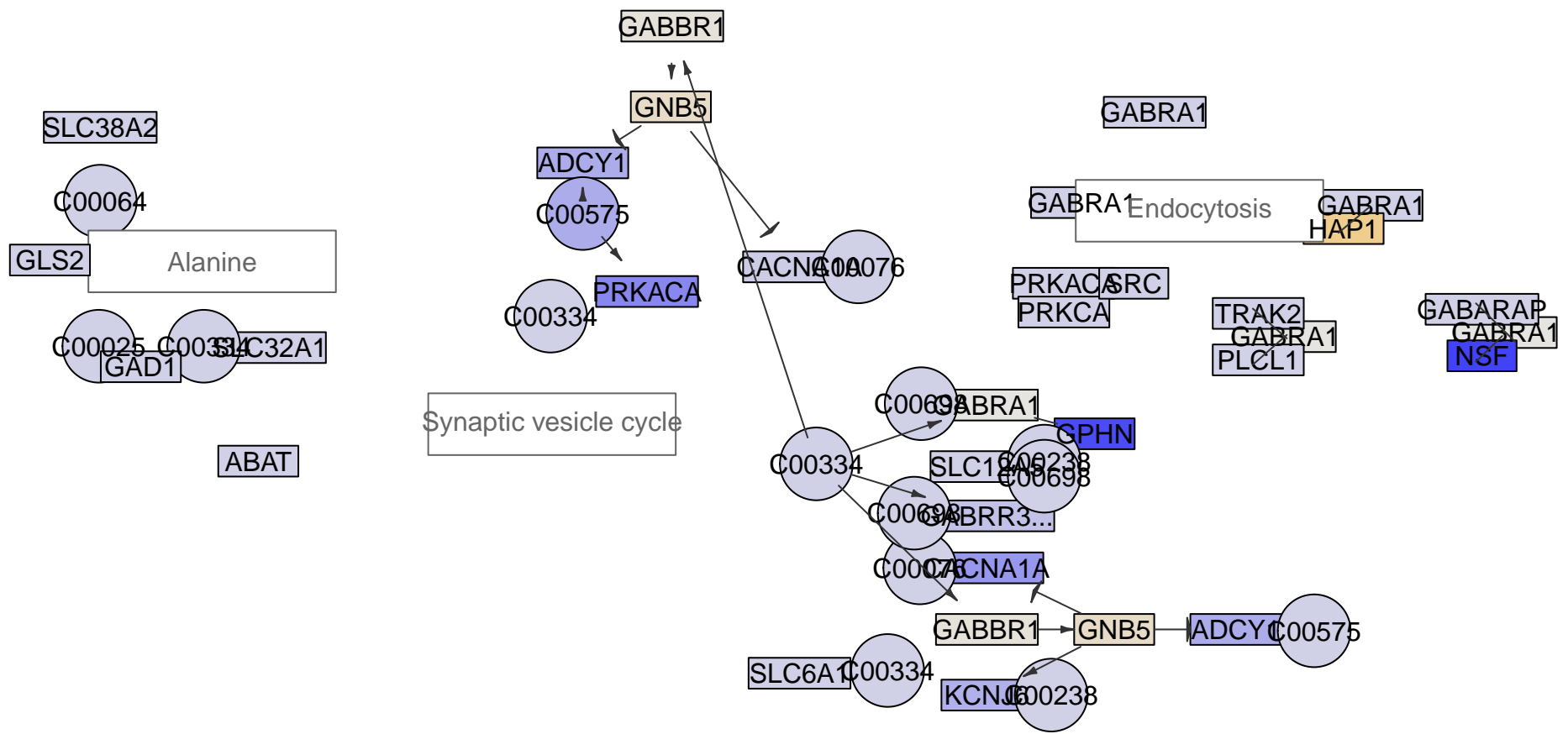

GABAergic synapse
MPI-222

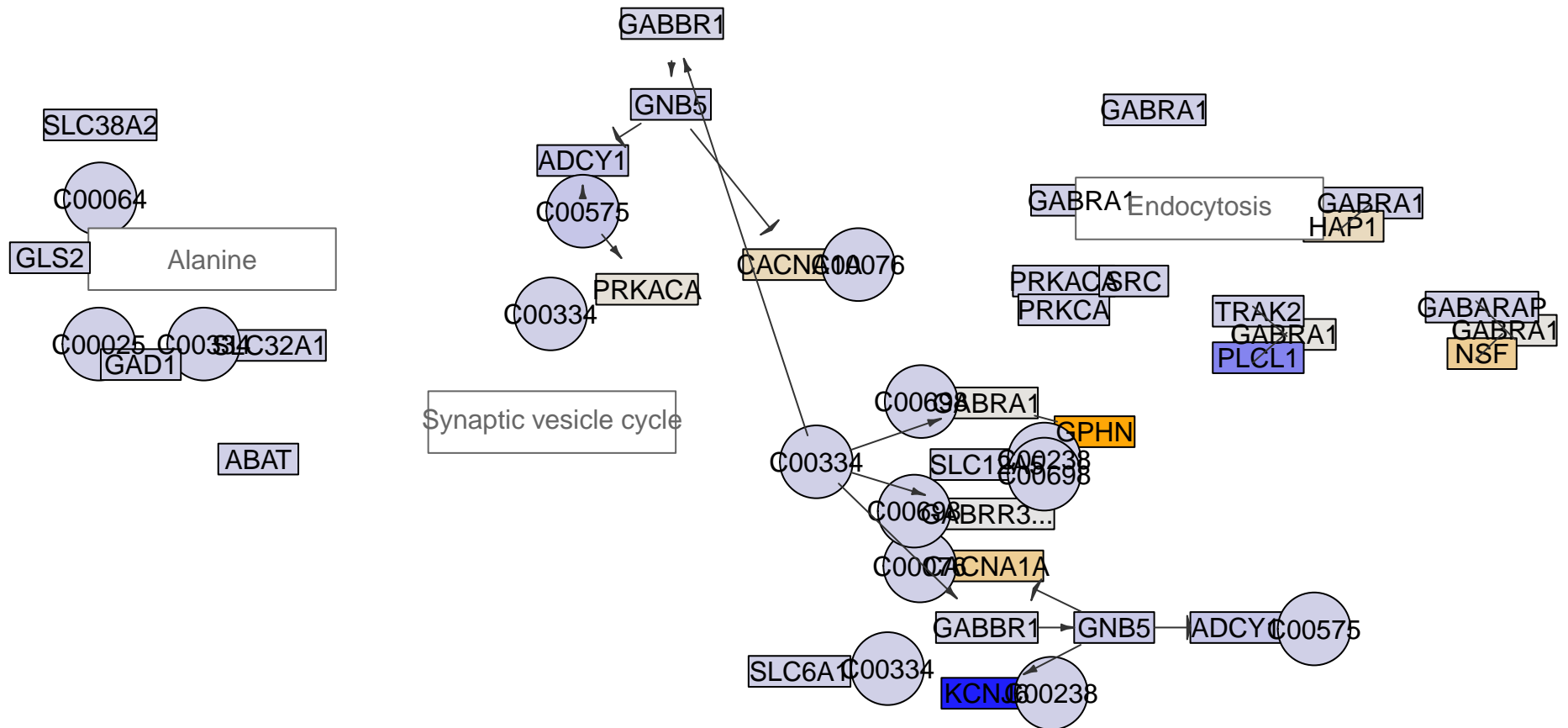

GABAergic synapse
MPI-225

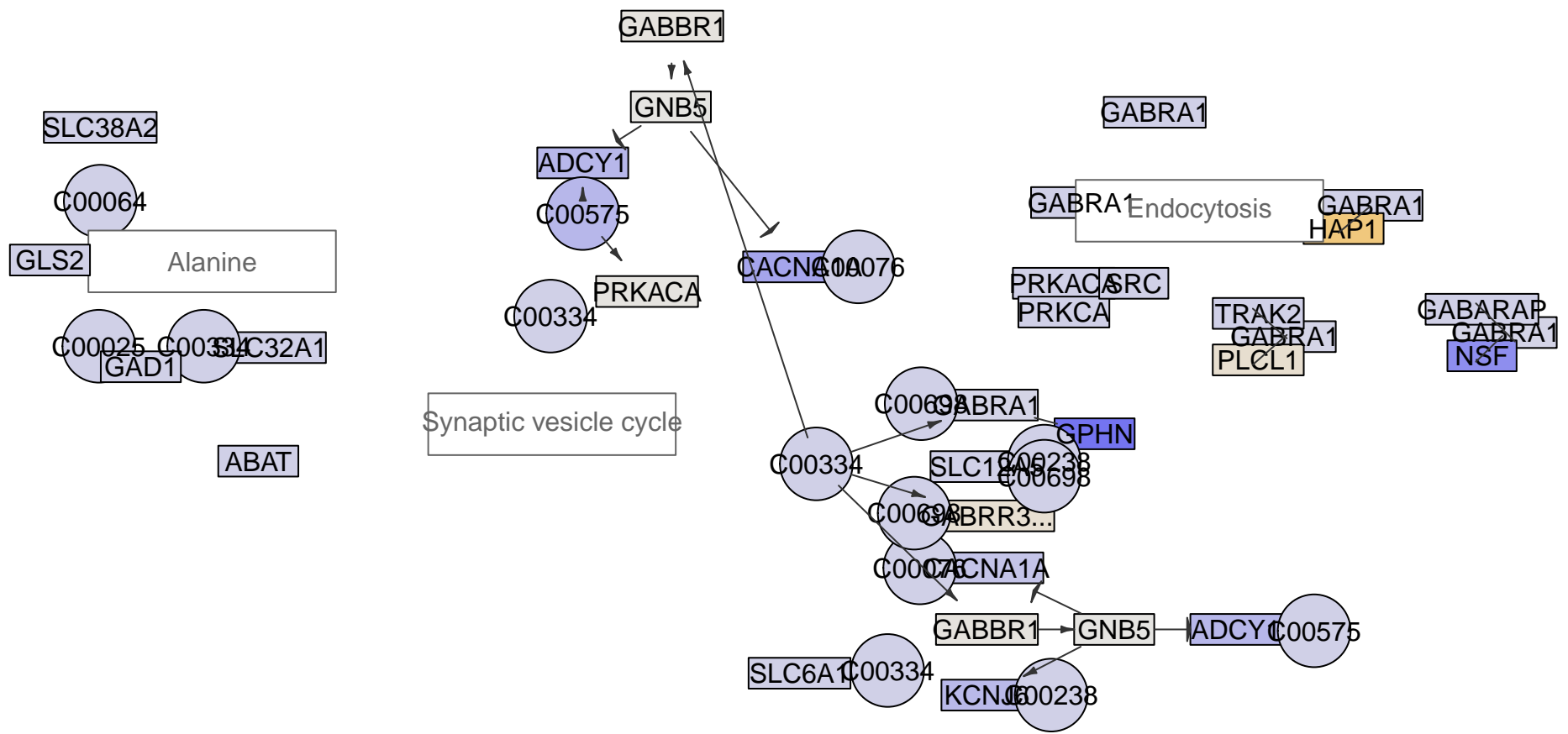

GABAergic synapse
MPI-242

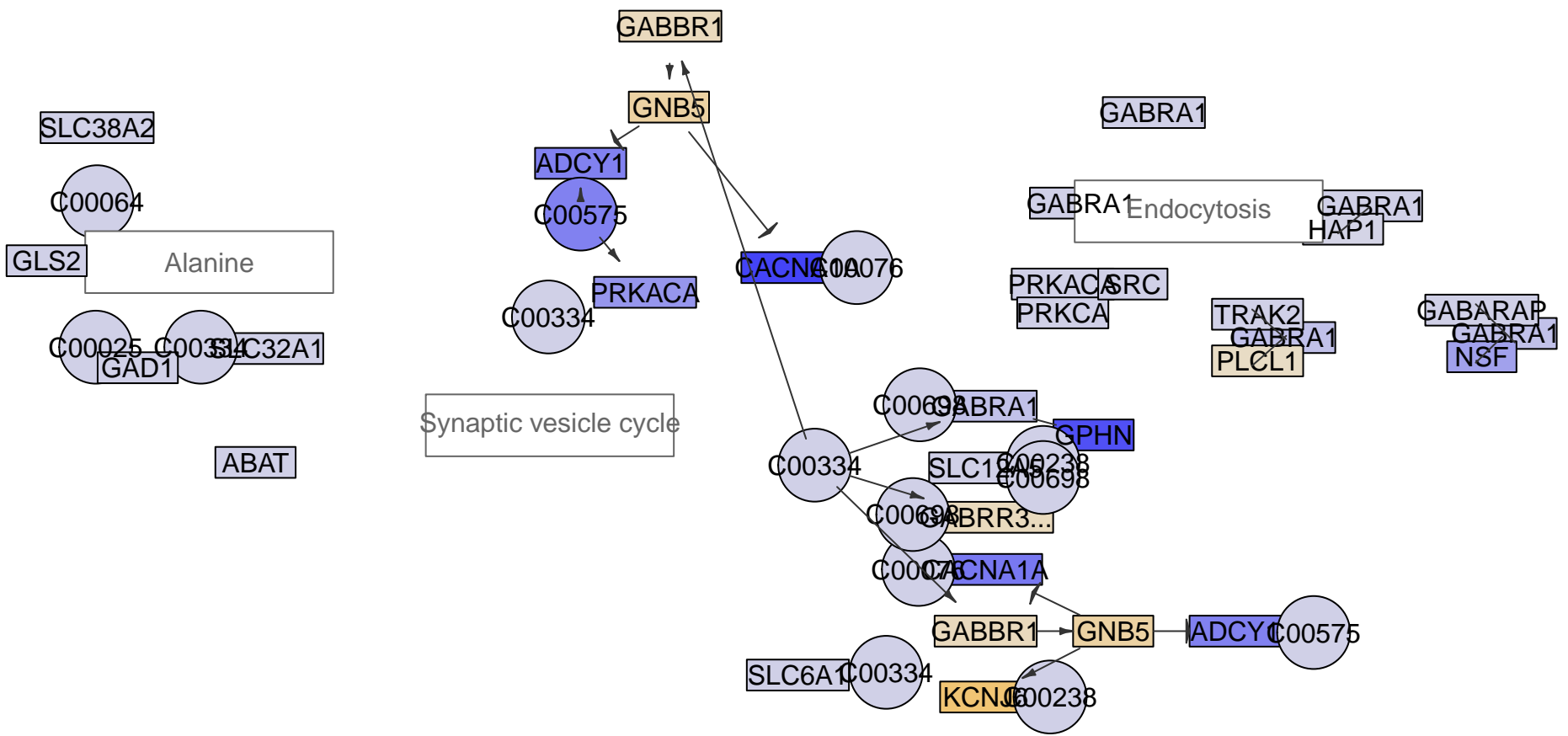

GABAergic synapse
MPI-245

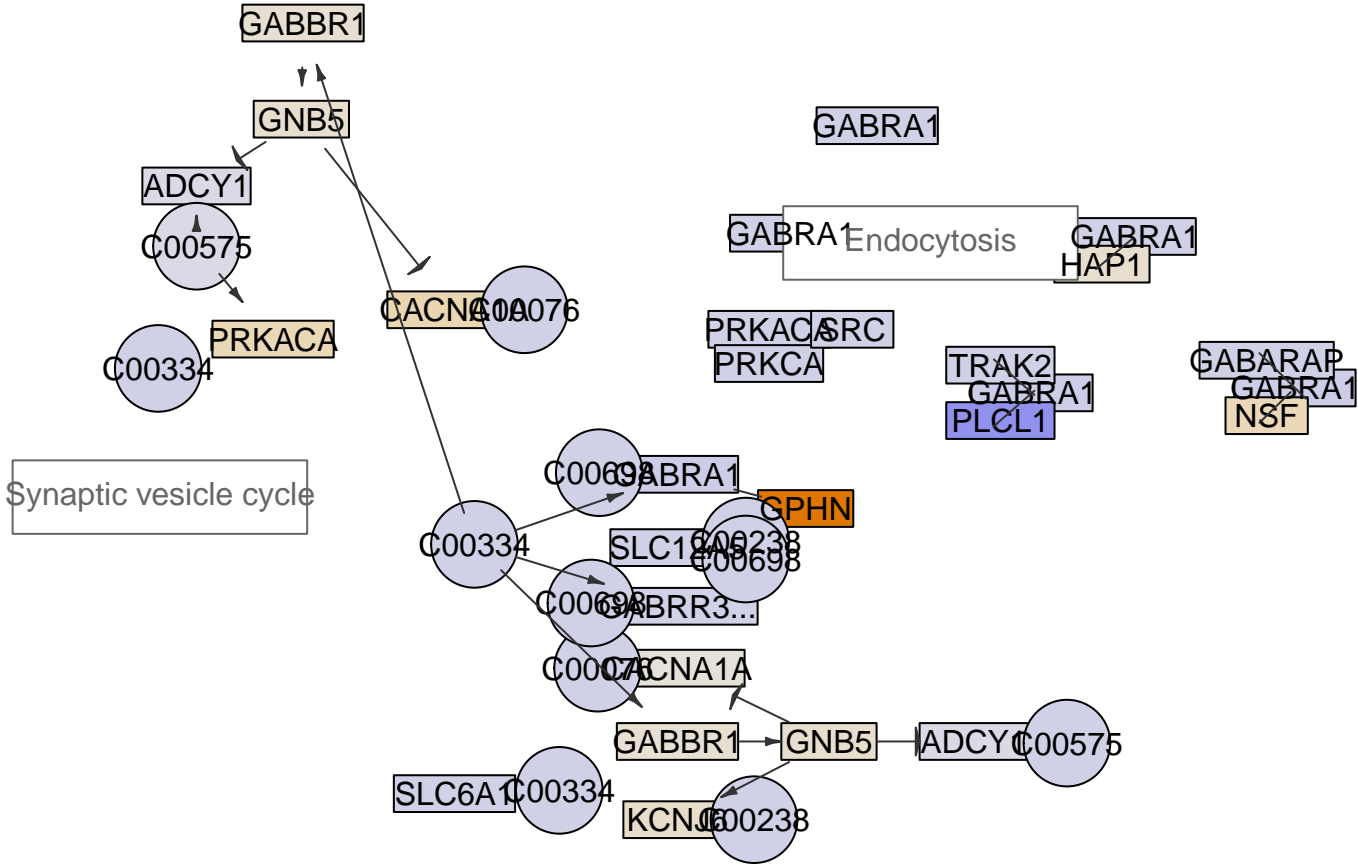
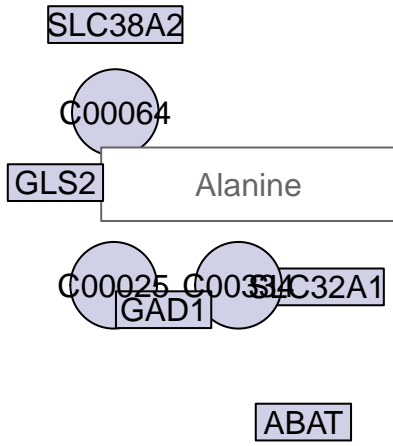
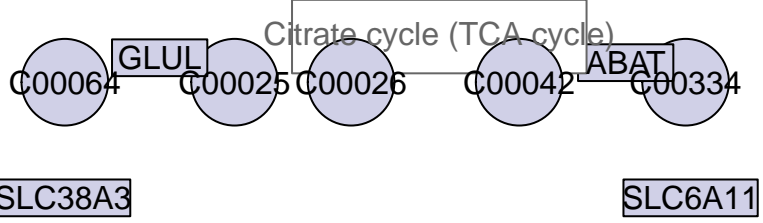

GABAergic synapse
MPI-248

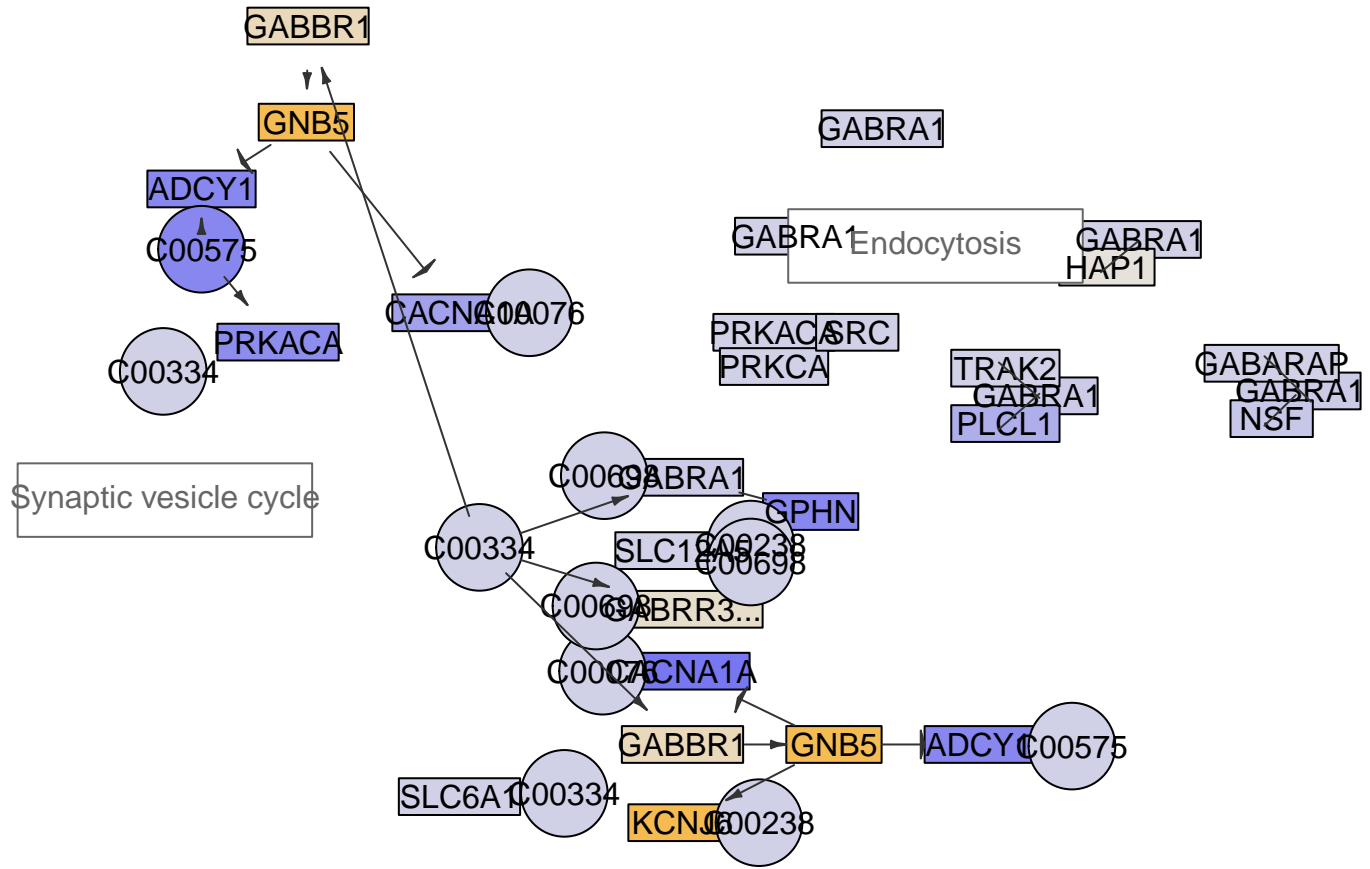
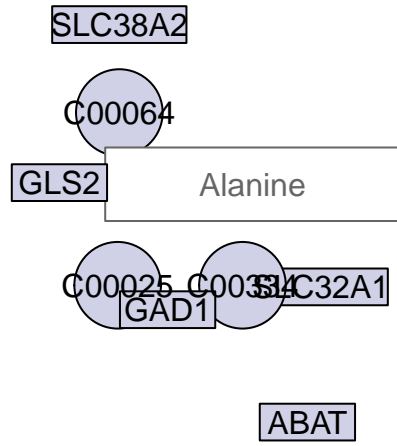

GABAergic synapse
MPI-249

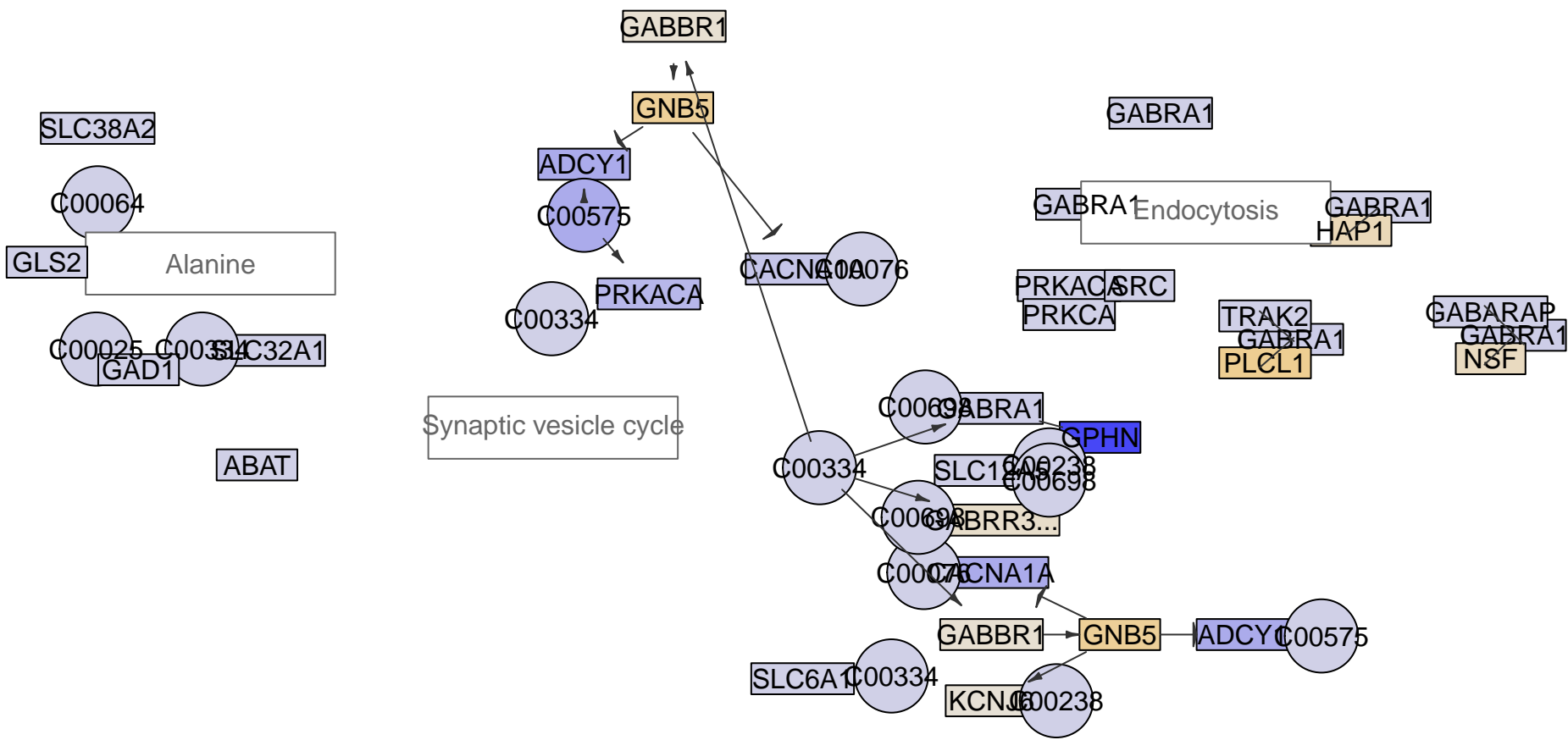

GABAergic synapse
MPI-250

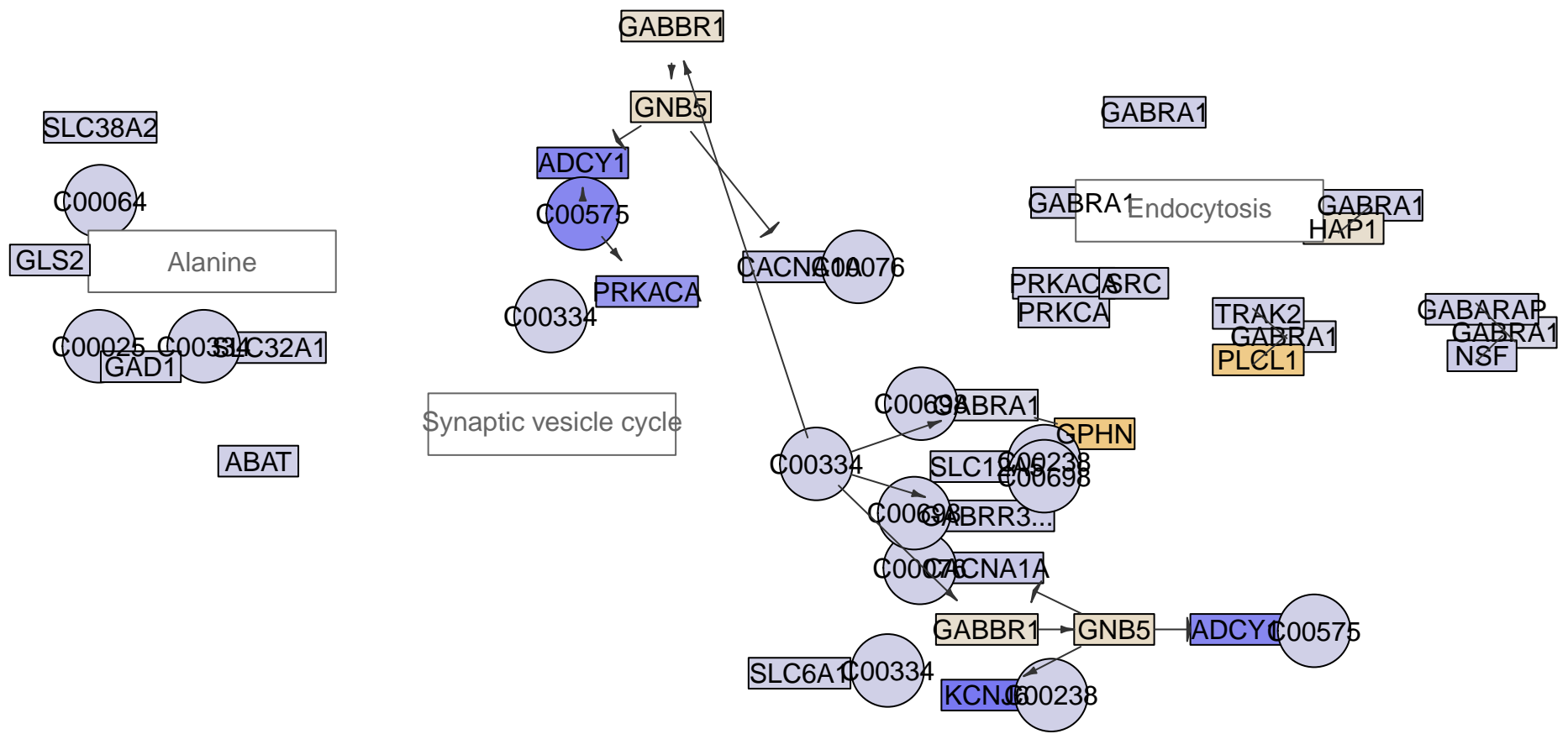

GABAergic synapse
MPI-008

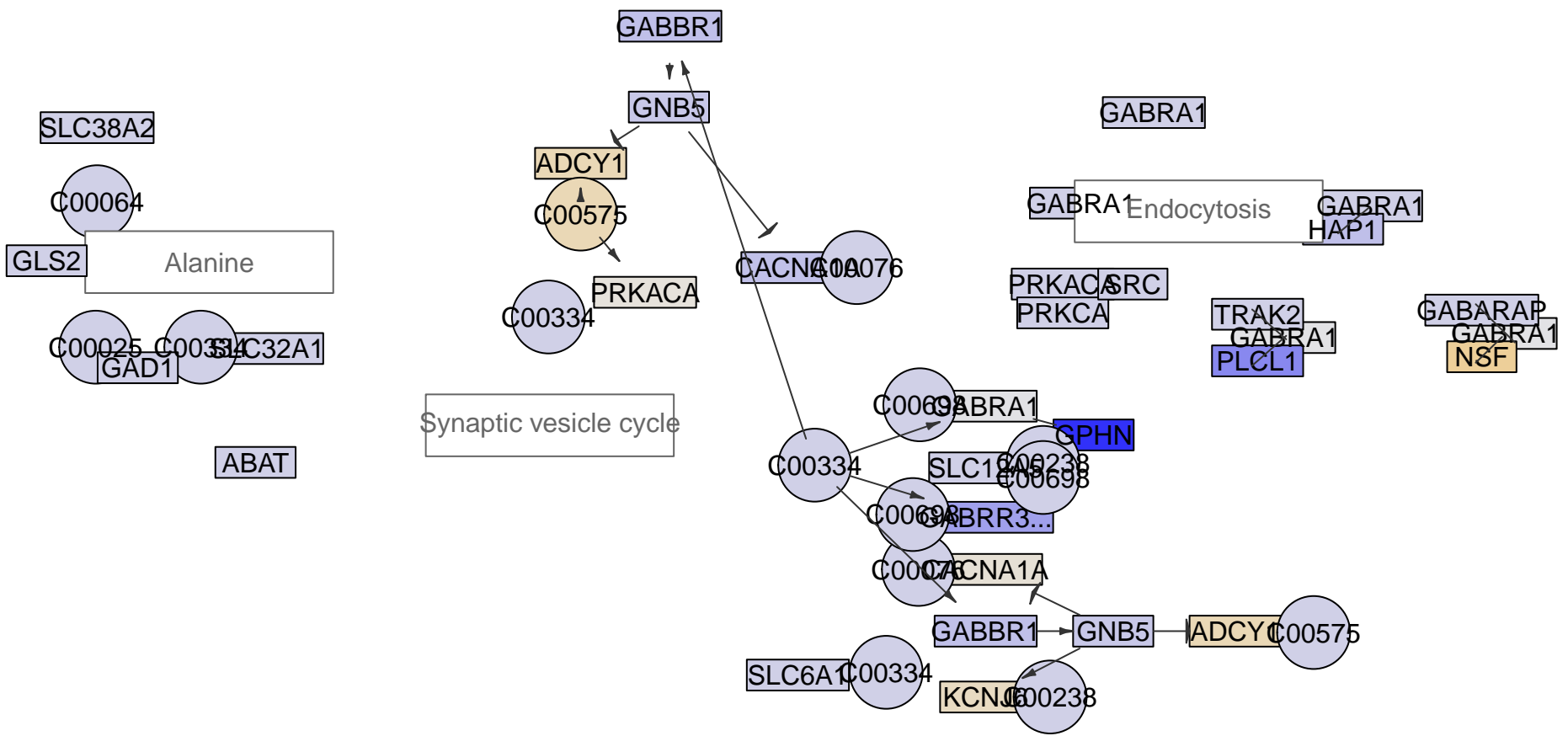

GABAergic synapse MPI-009

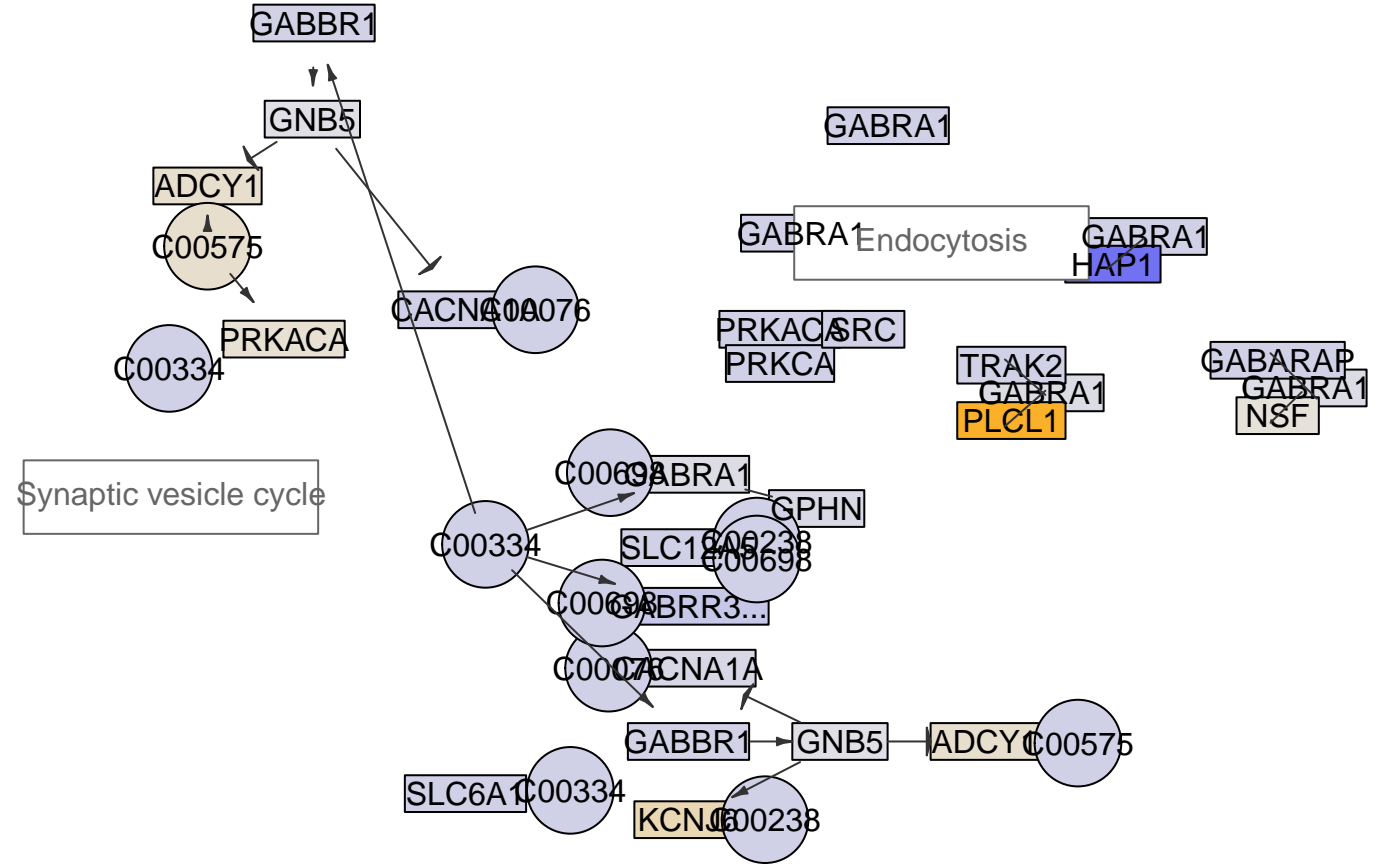
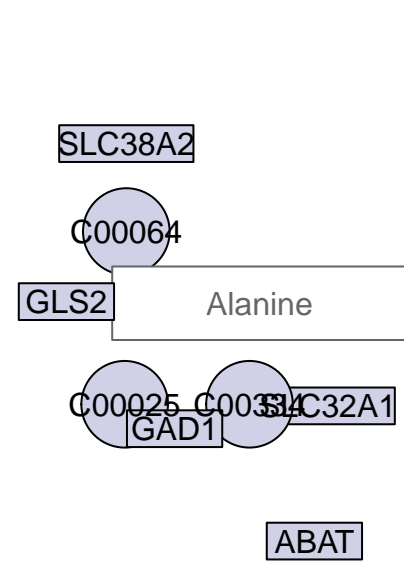

GABAergic synapse
MPI-010

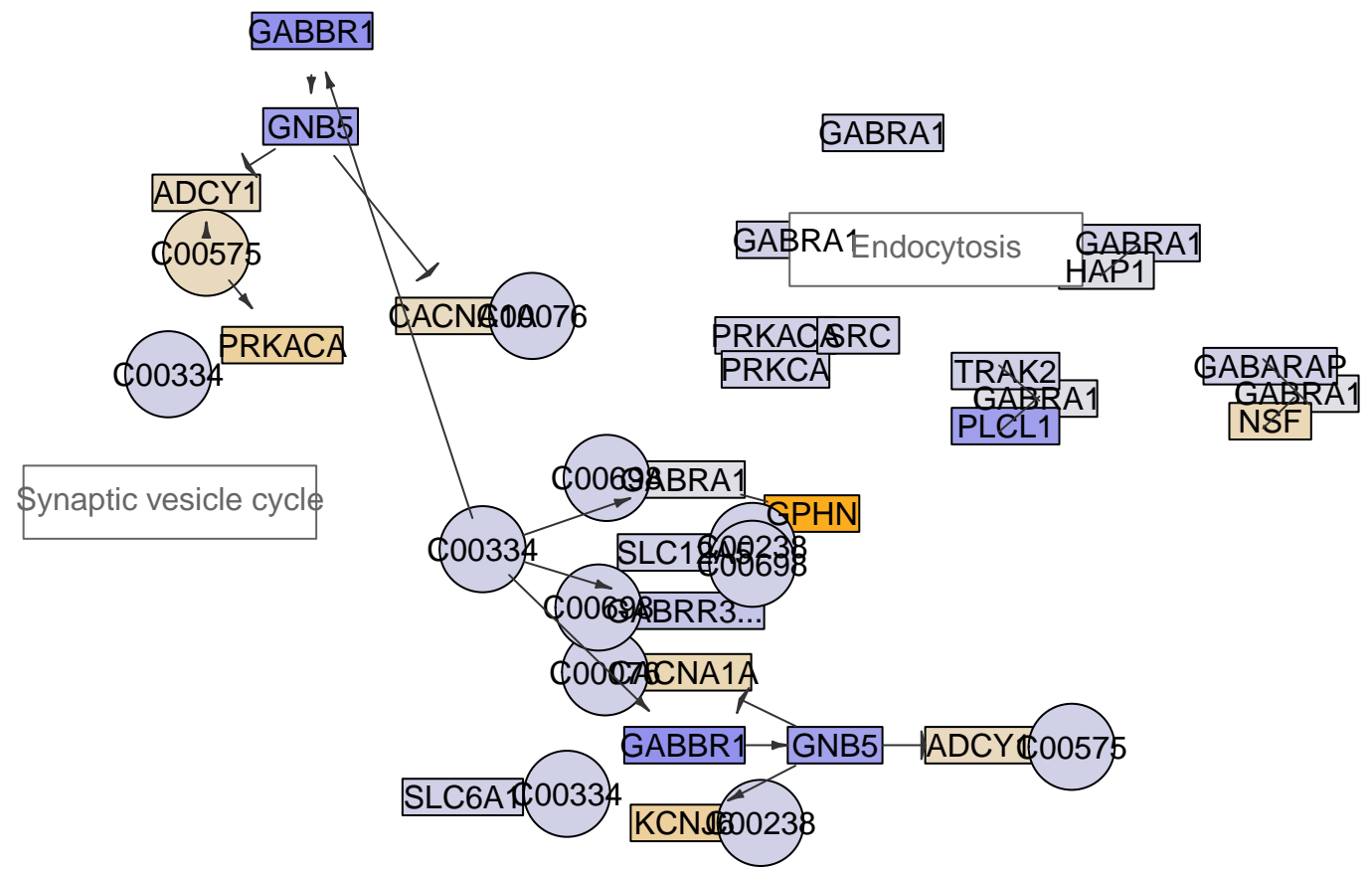
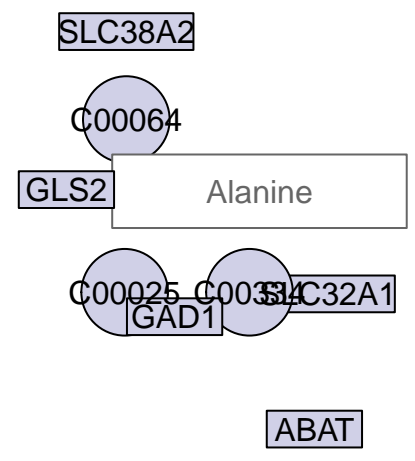

GABAergic synapse
MPI-012

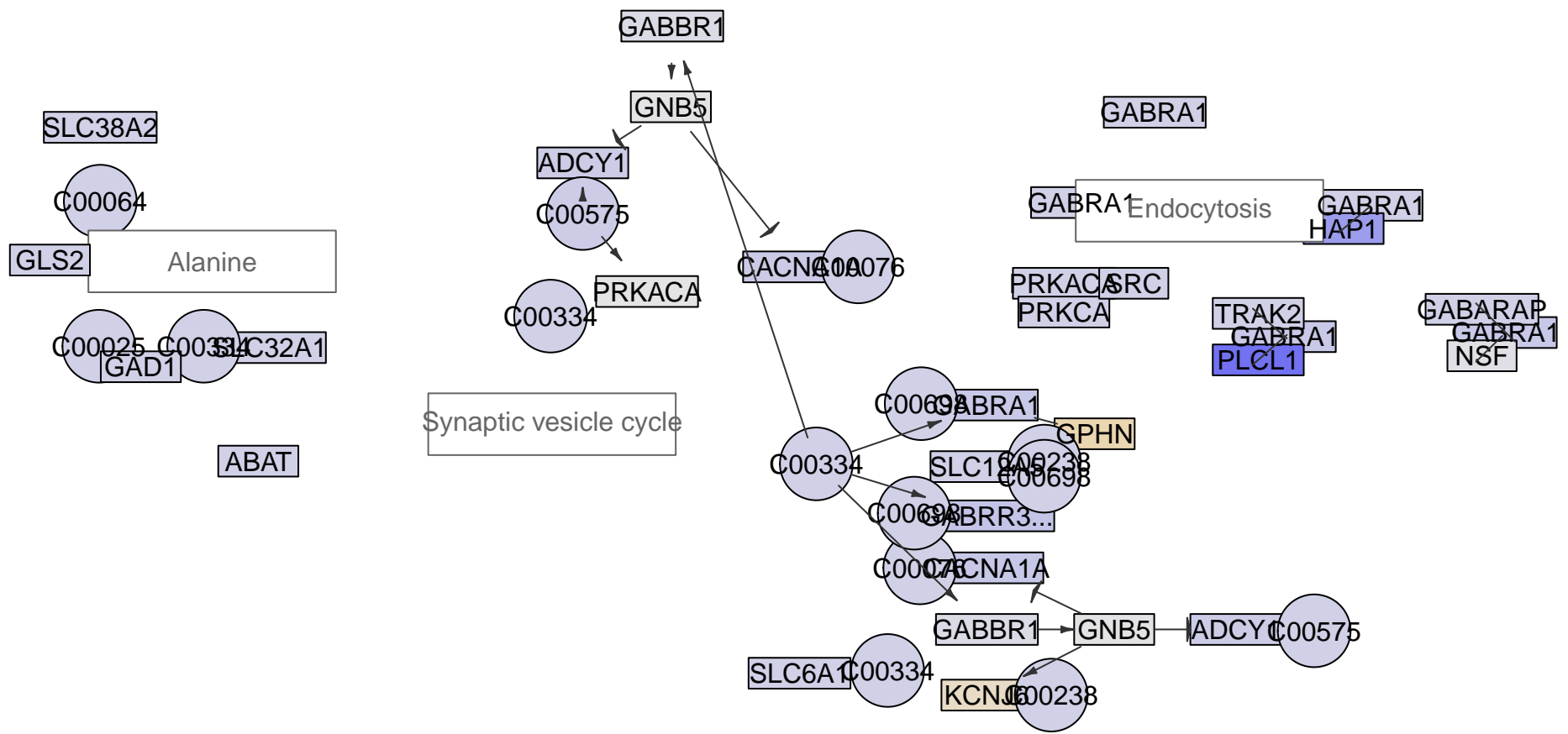

GABAergic synapse
MPI-013

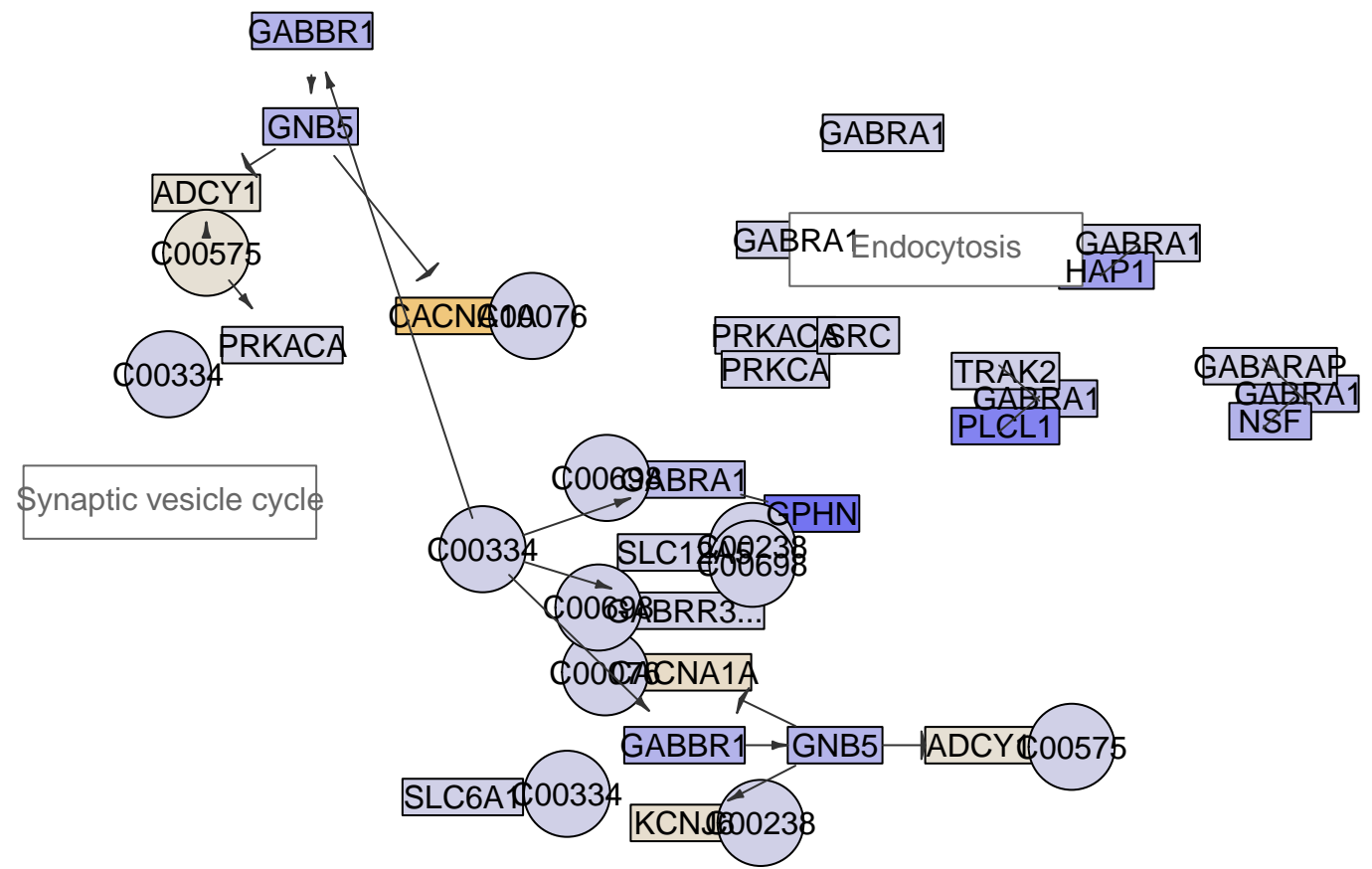
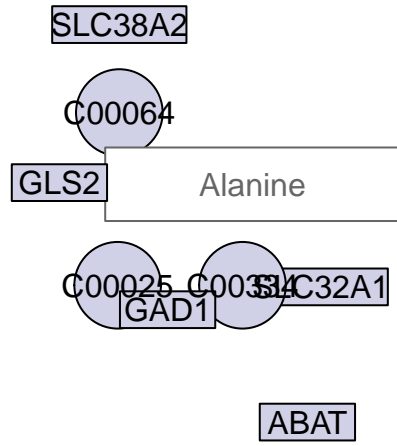

GABAergic synapse
MPI-014

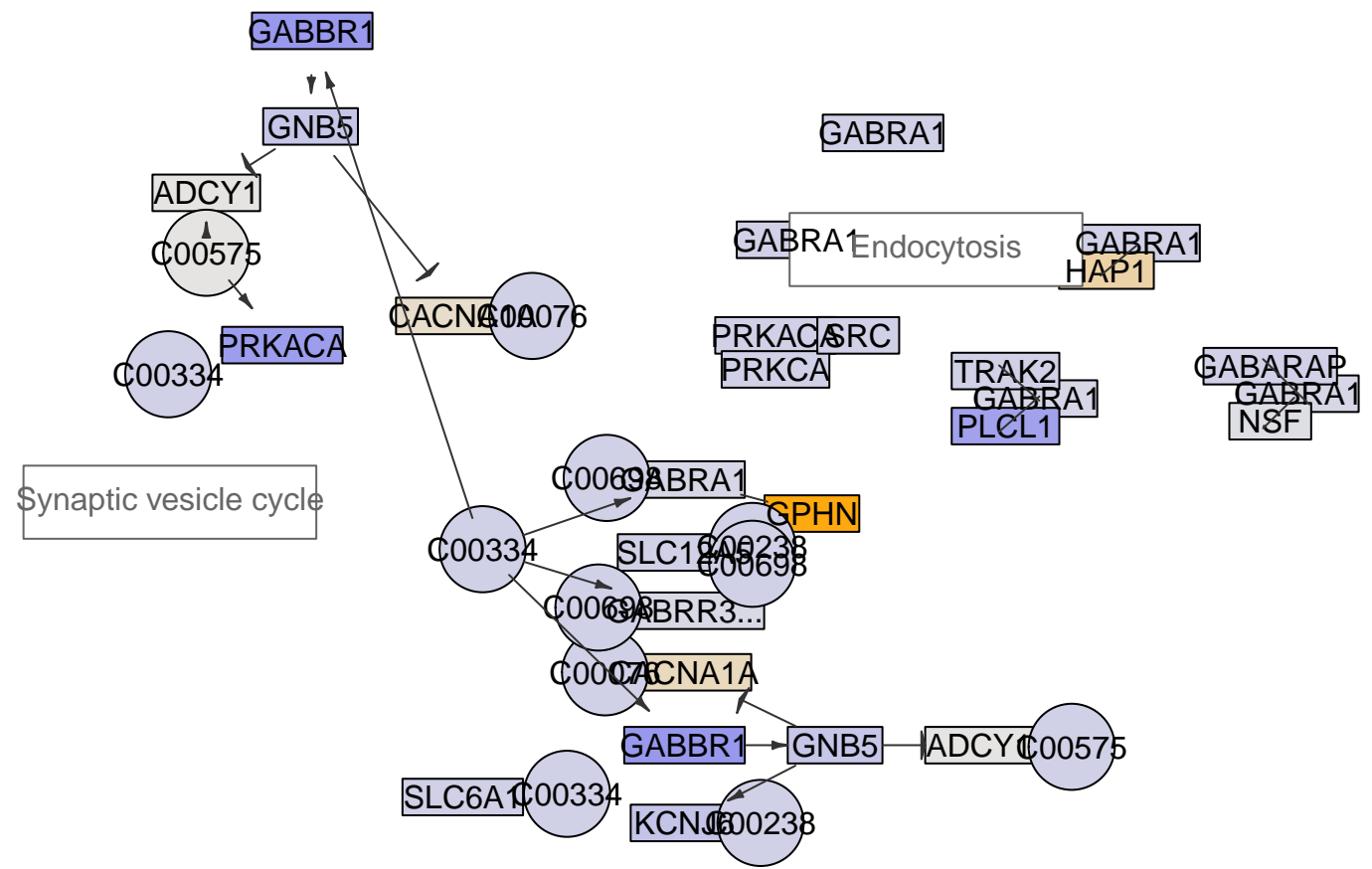
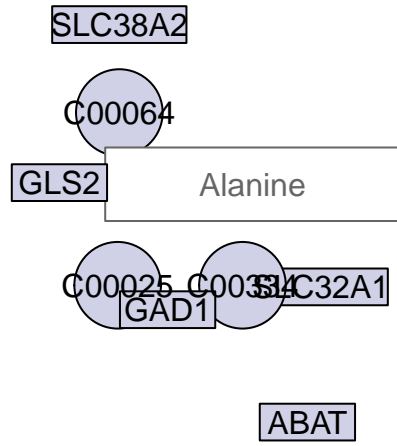

GABAergic synapse
MPI-015

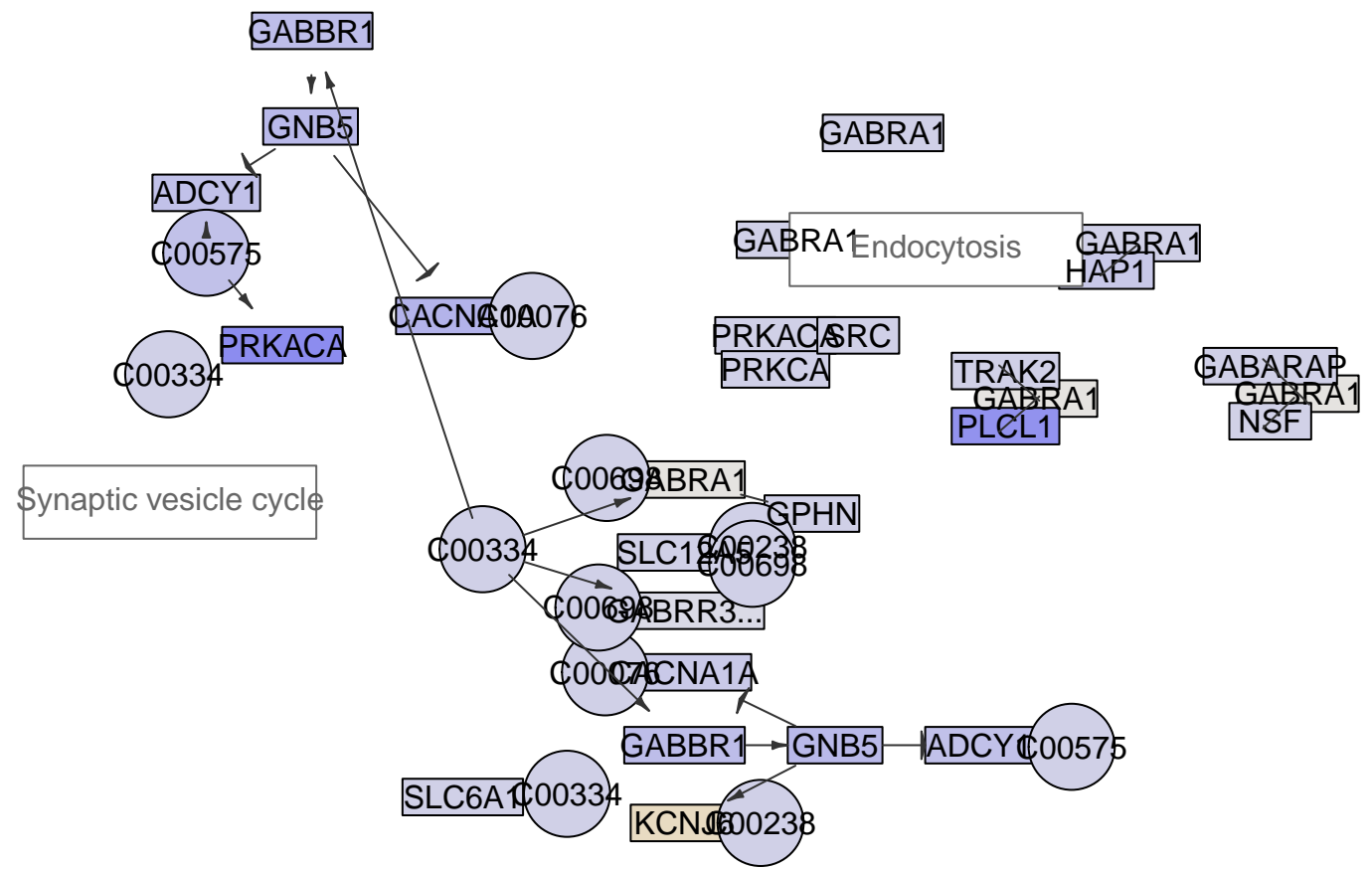
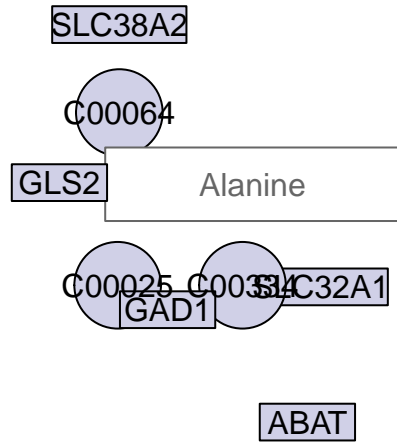

GABAergic synapse
MPI-021

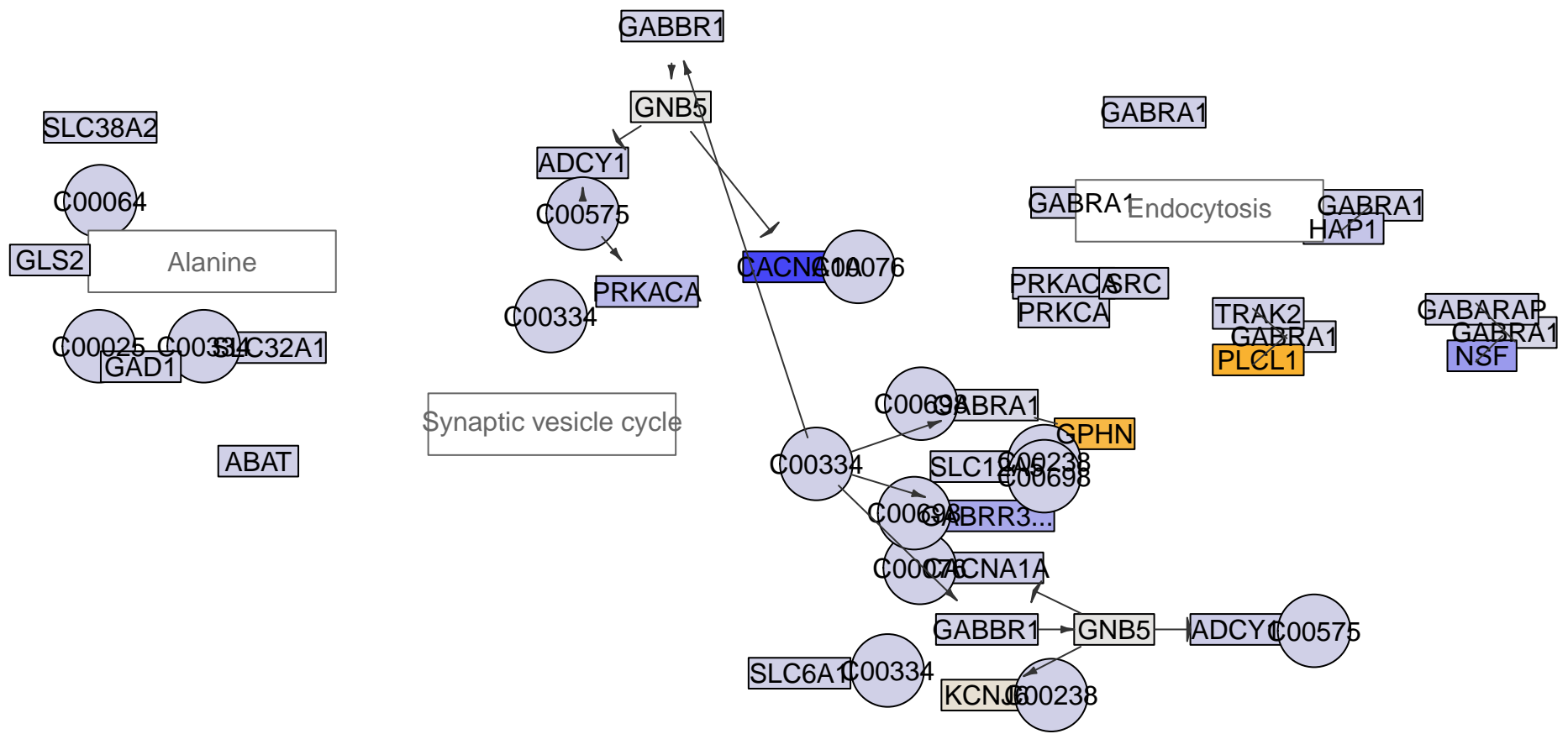

GABAergic synapse
MPI-022

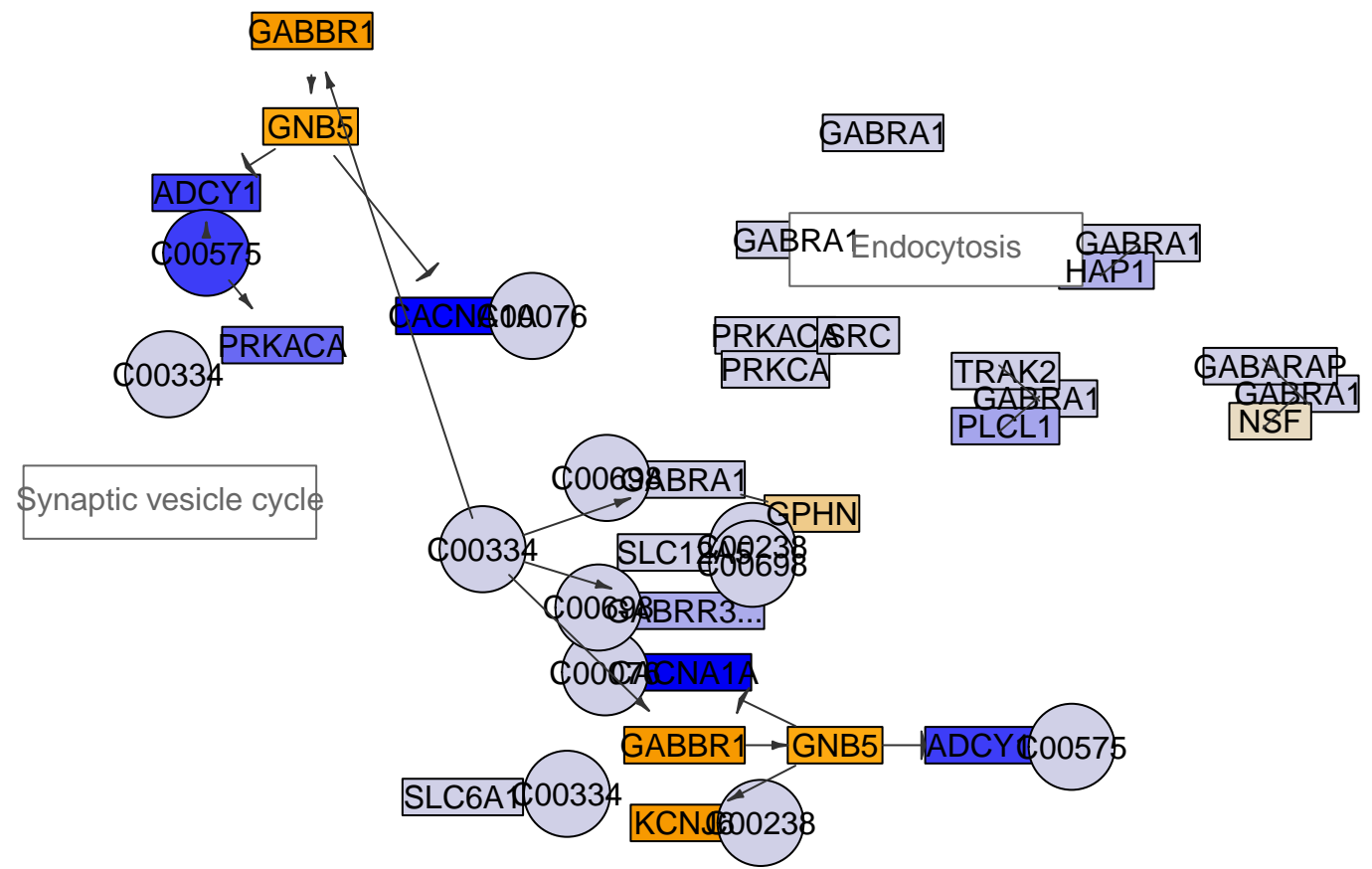
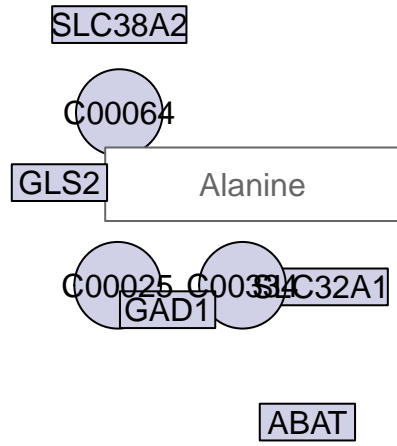

GABAergic synapse
MPI-025

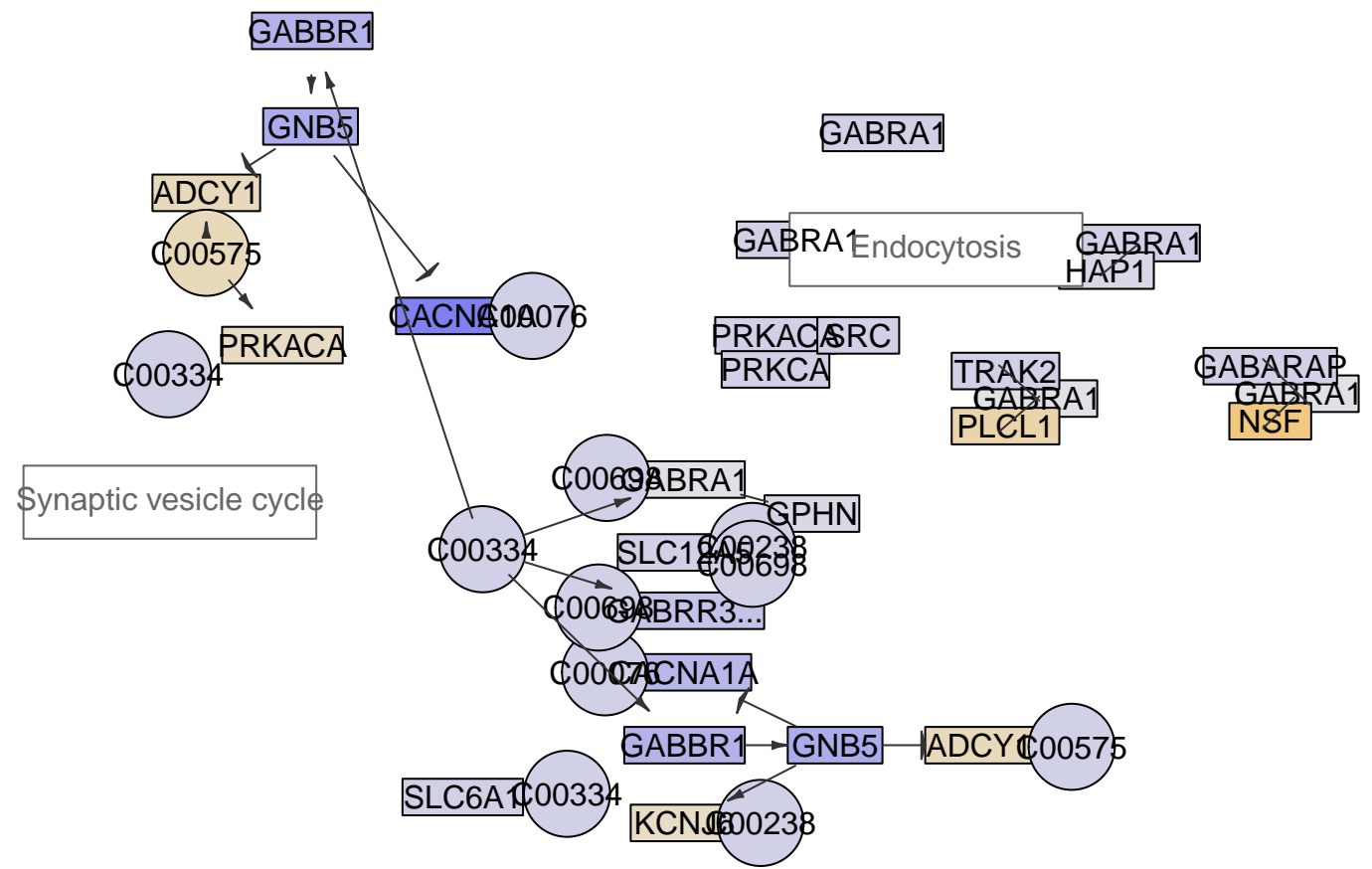
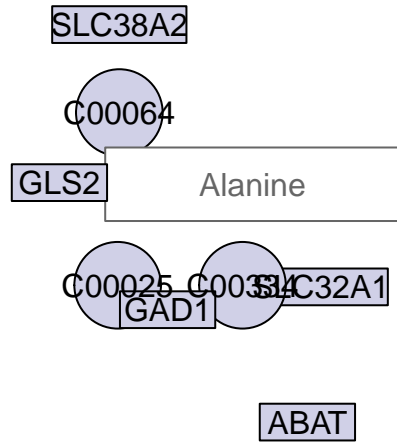

GABAergic synapse
MPI-029

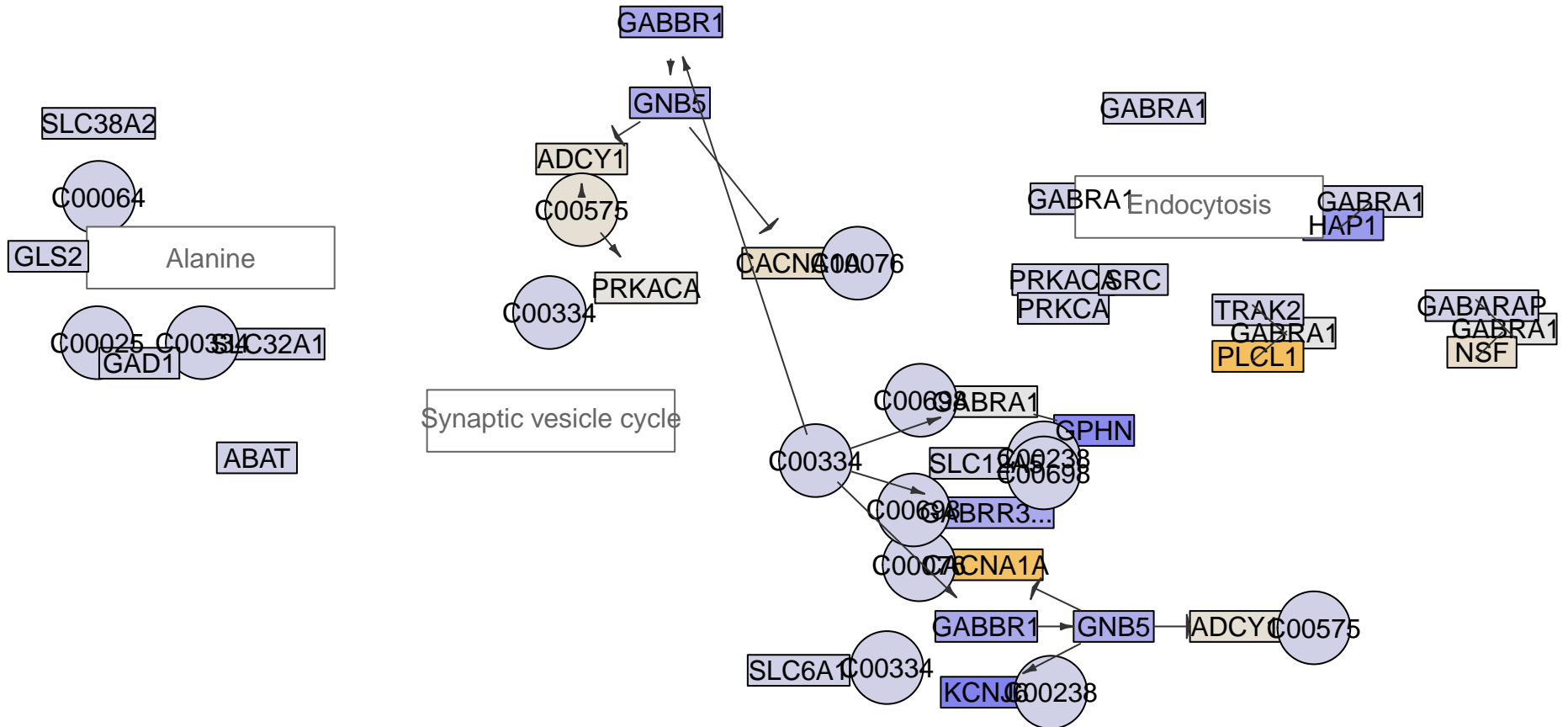
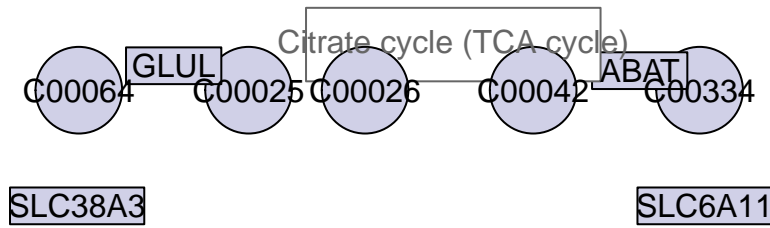

GABAergic synapse
MPI-030

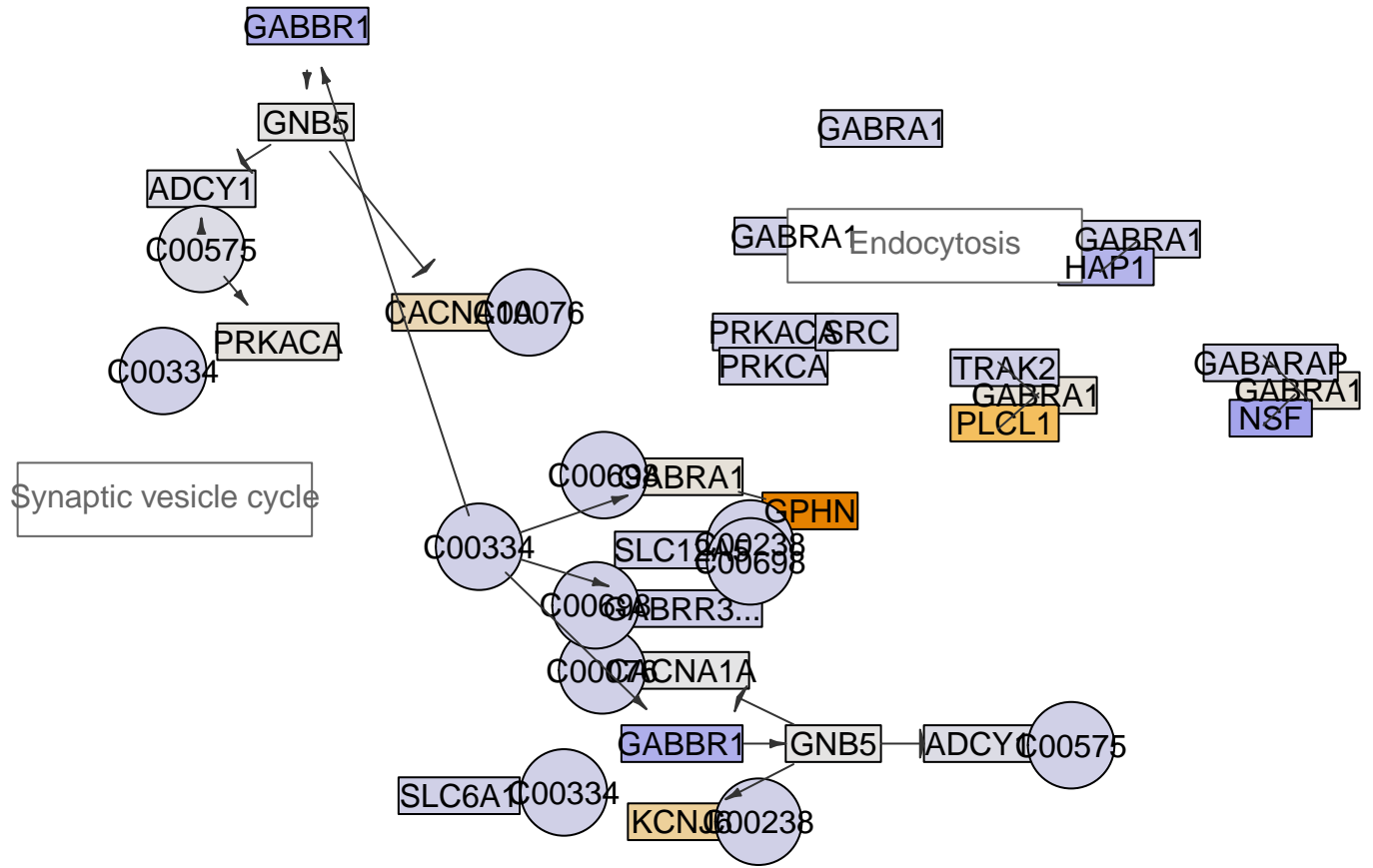
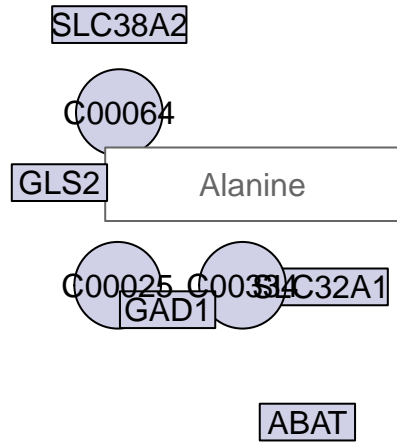

GABAergic synapse
MPI-031

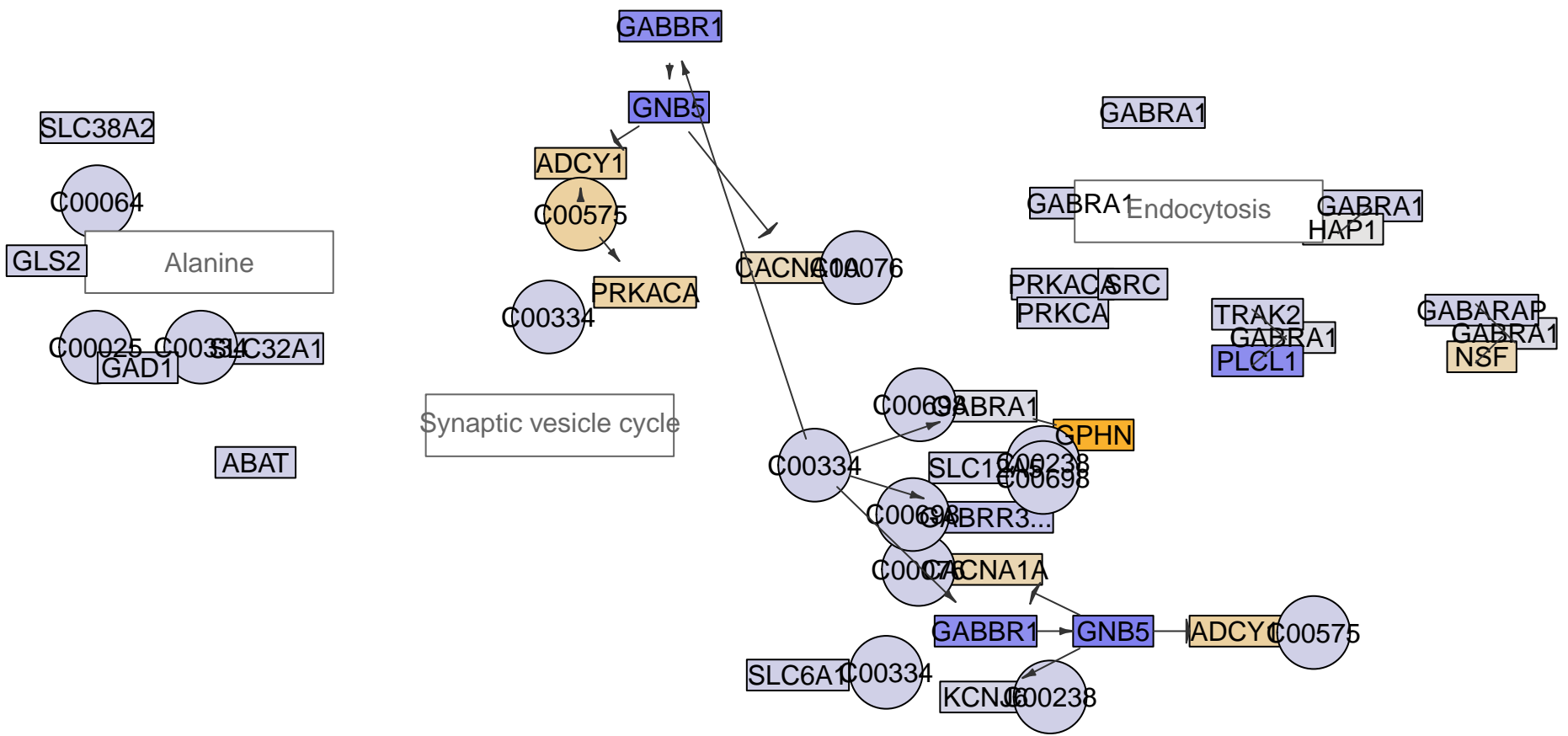

GABAergic synapse
MPI-039

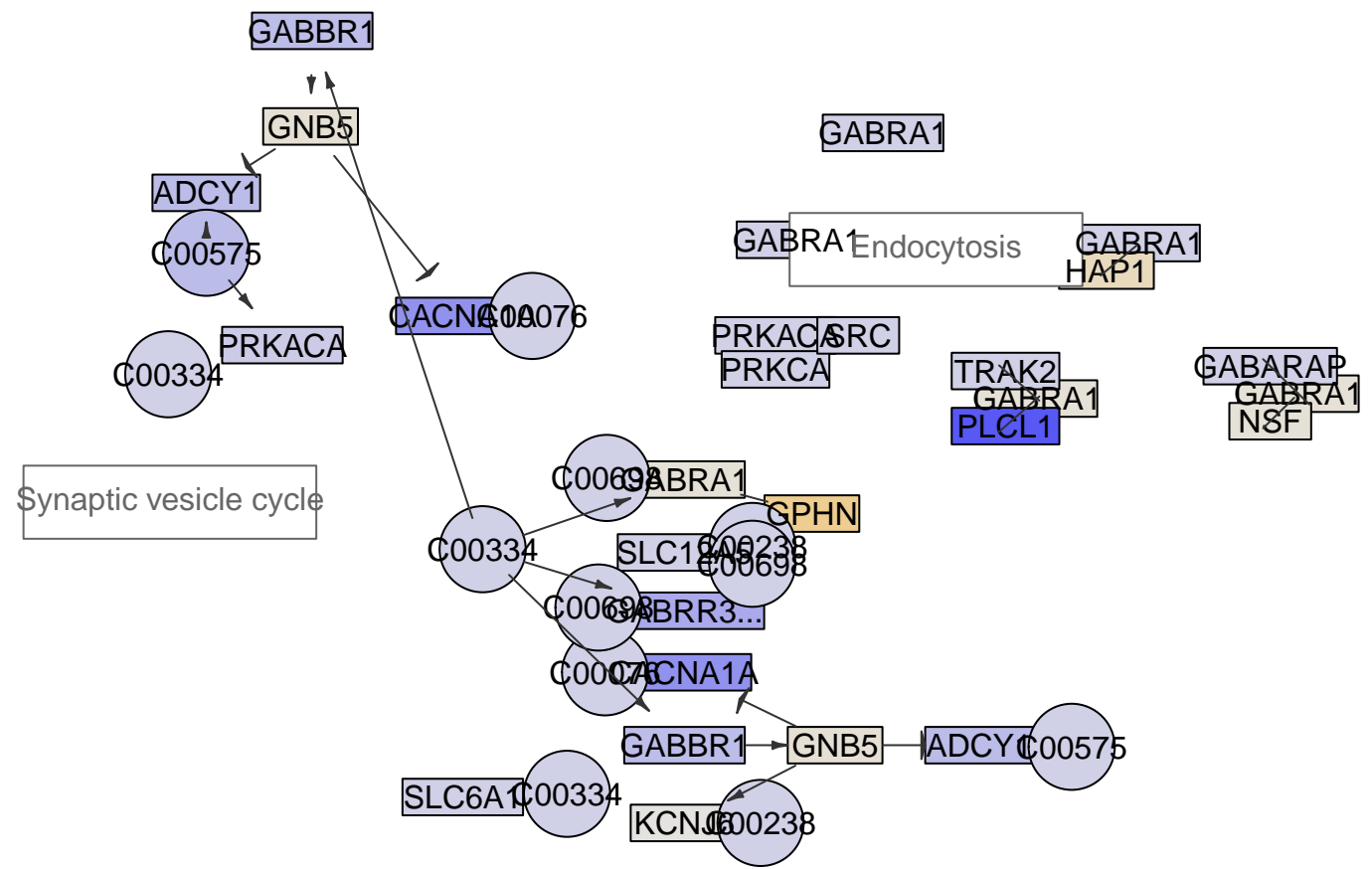
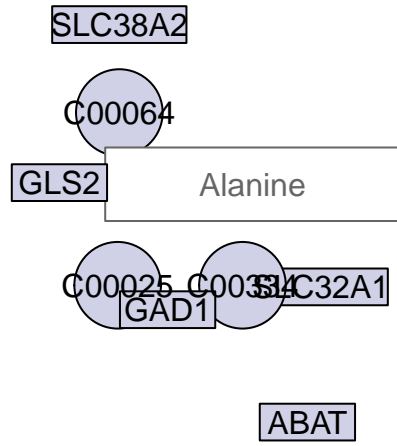

GABAergic synapse
MPI-040

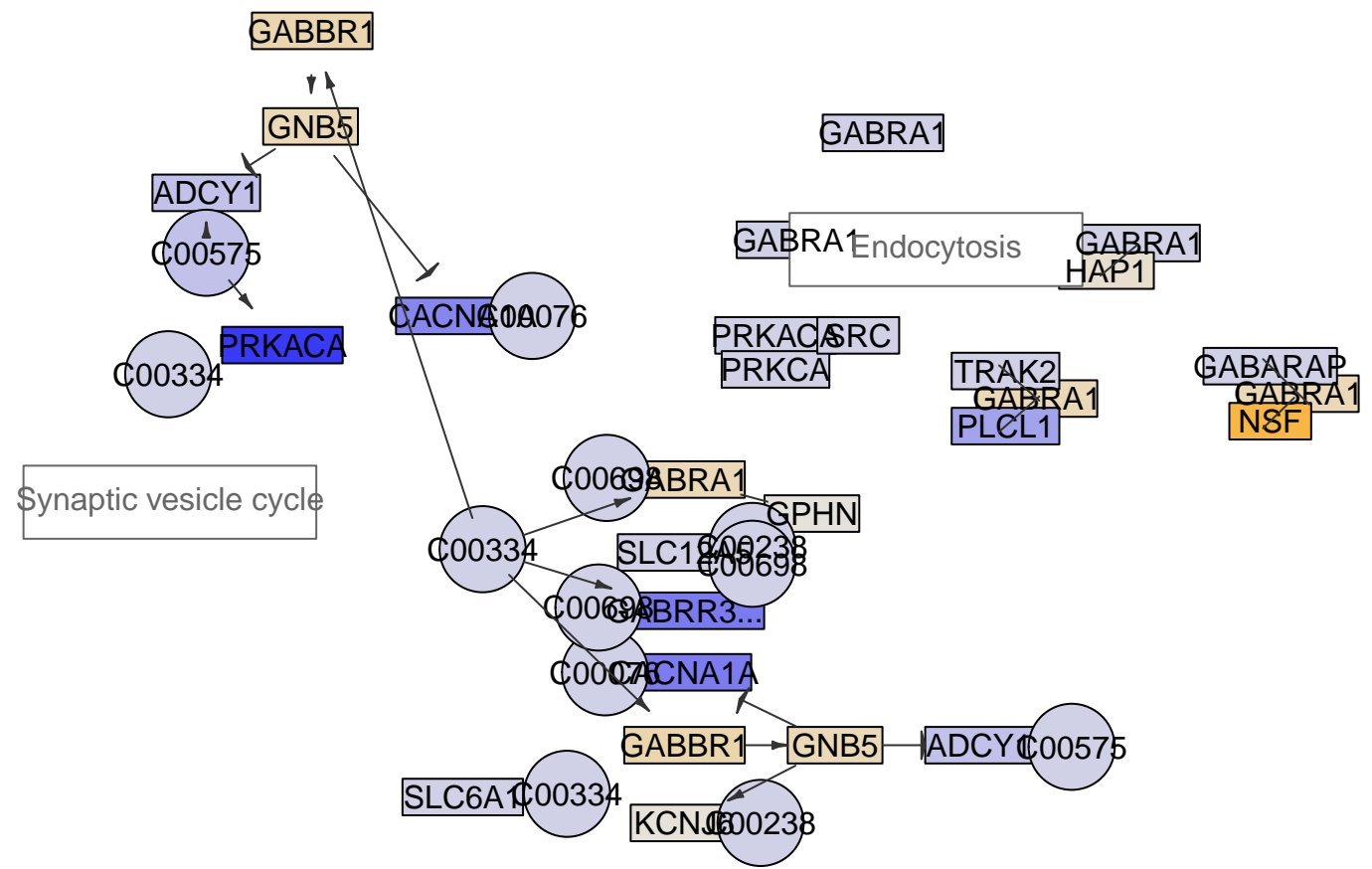
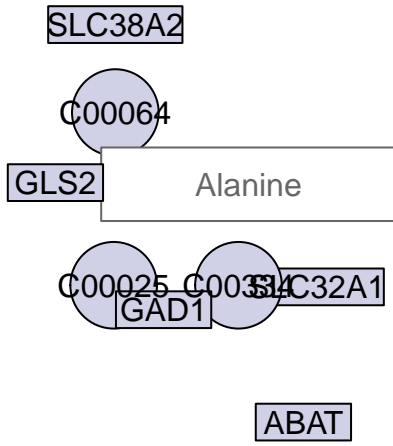

GABAergic synapse
MPI-045

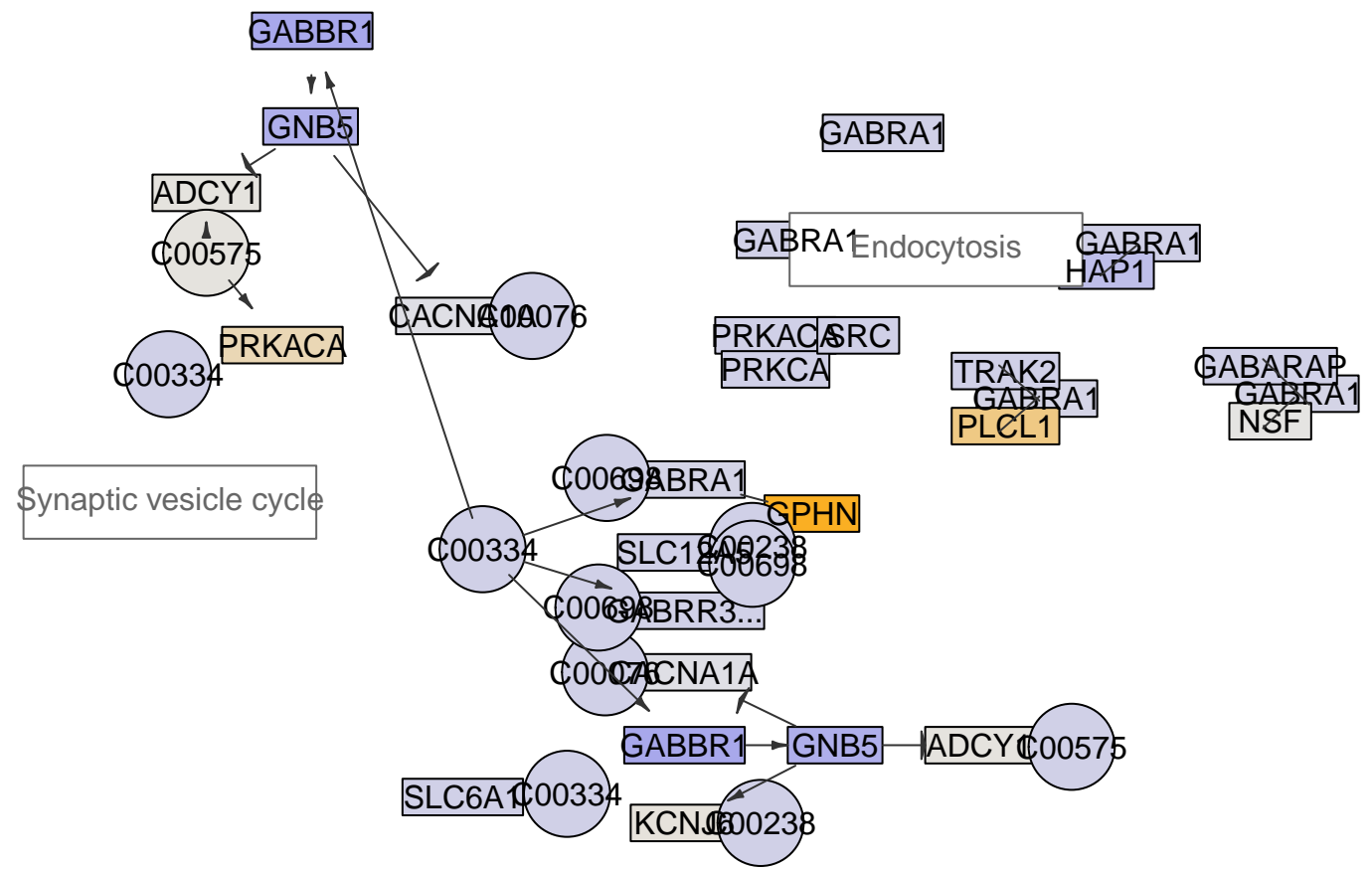
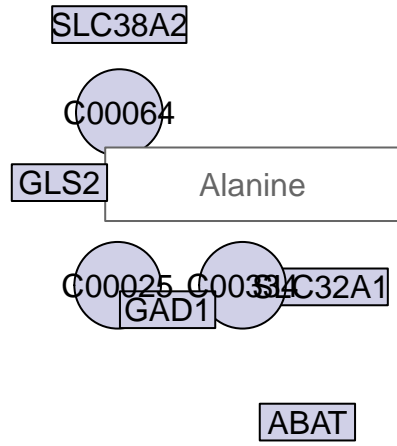

GABAergic synapse
MPI-047

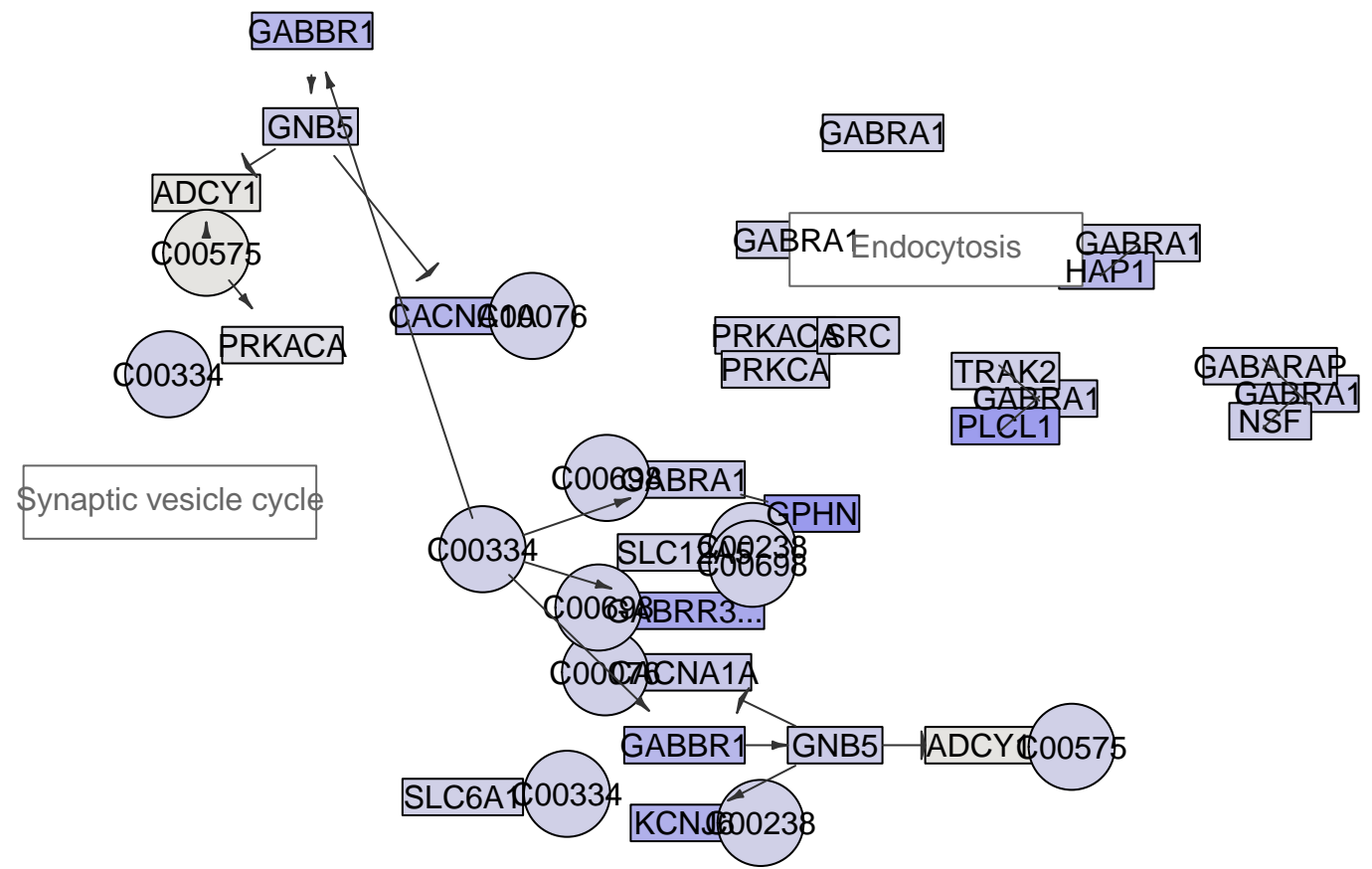
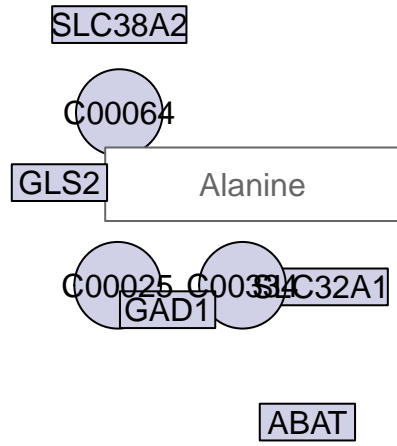

GABAergic synapse
MPI-053

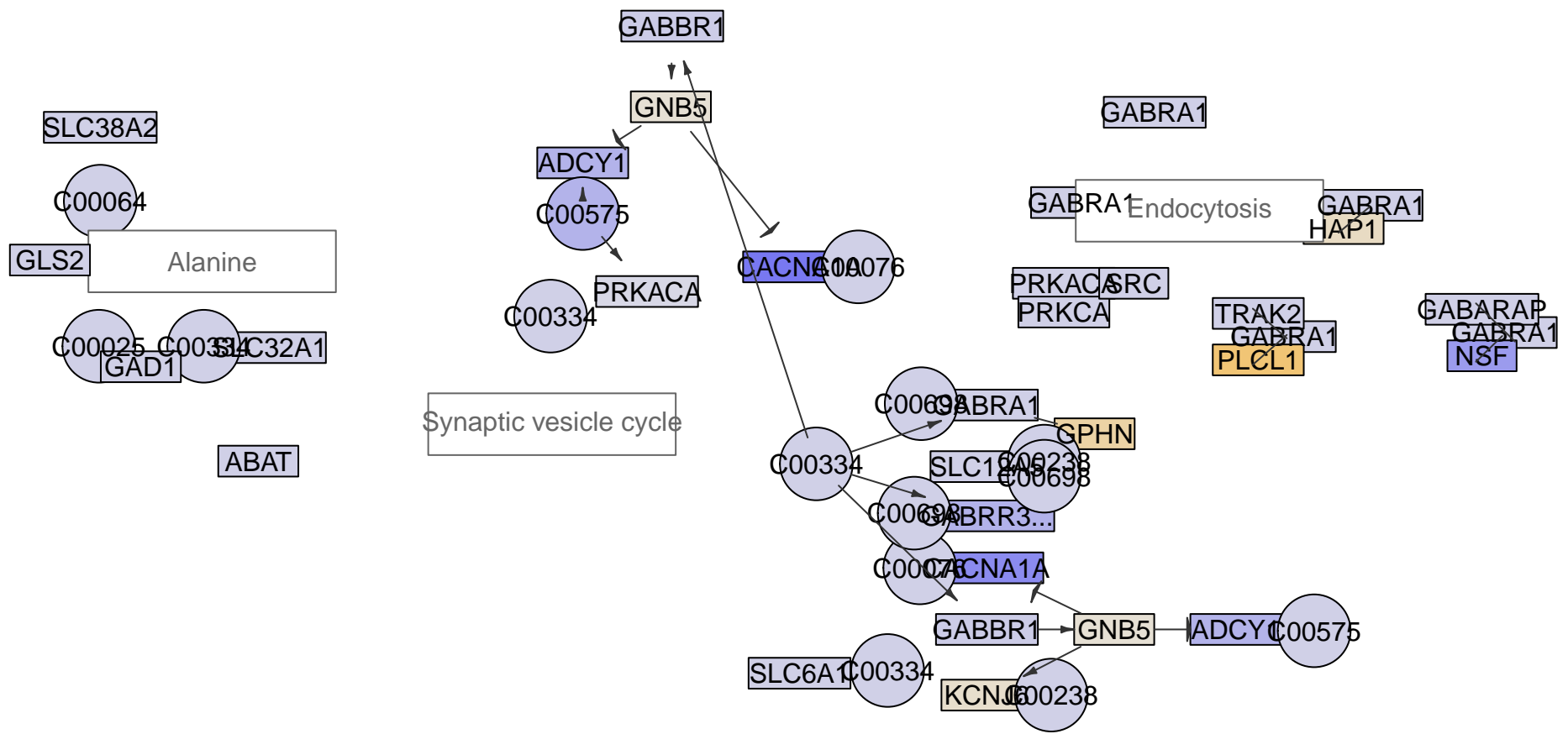

GABAergic synapse
MPI-062

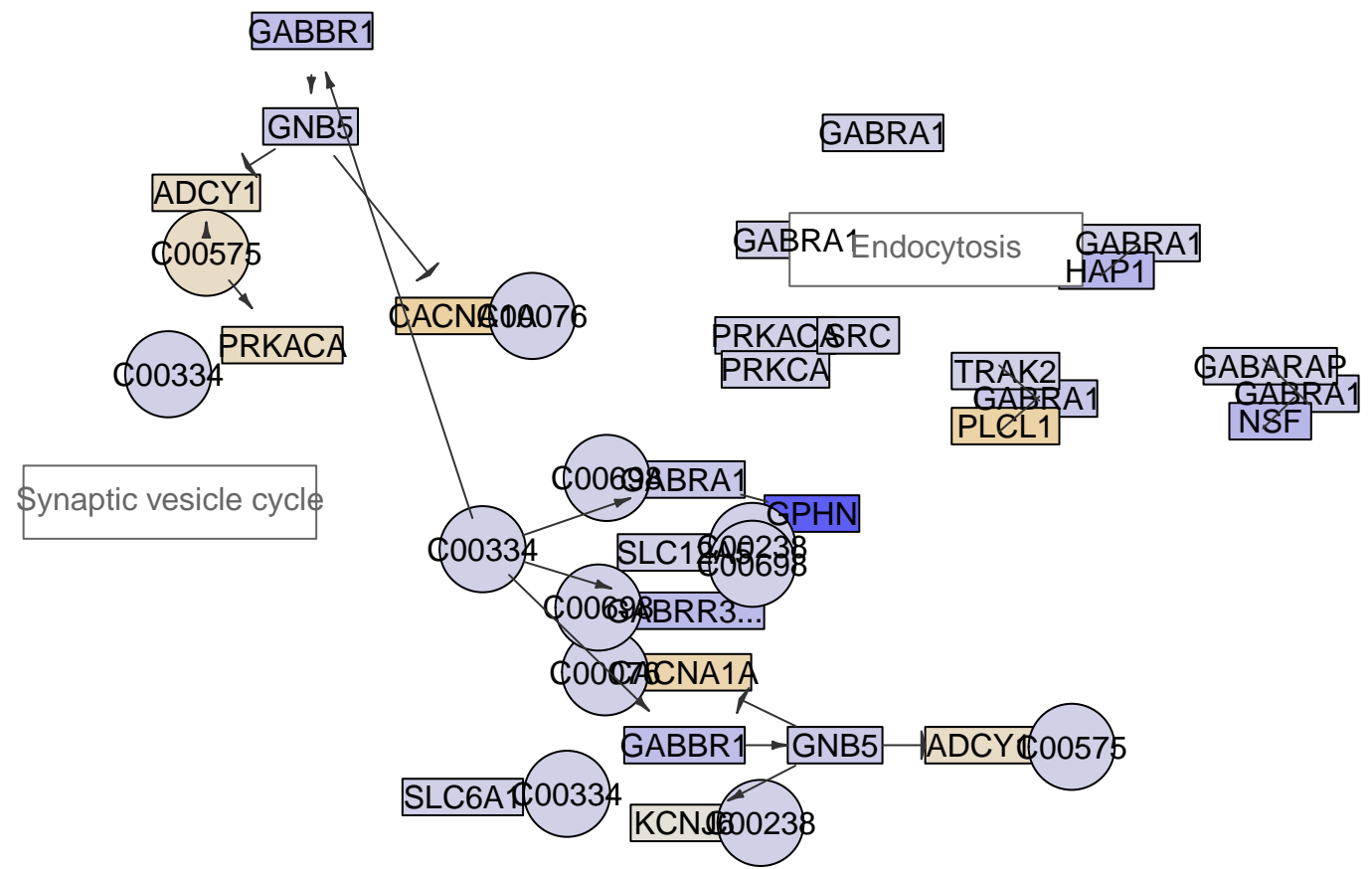
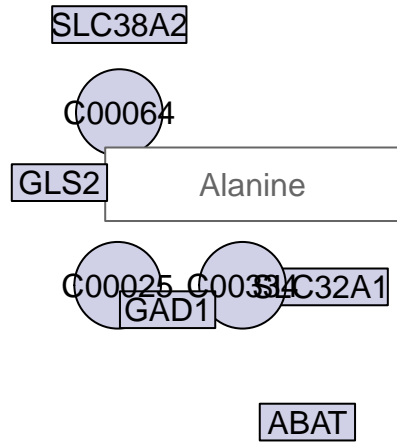

GABAergic synapse
MPI-063

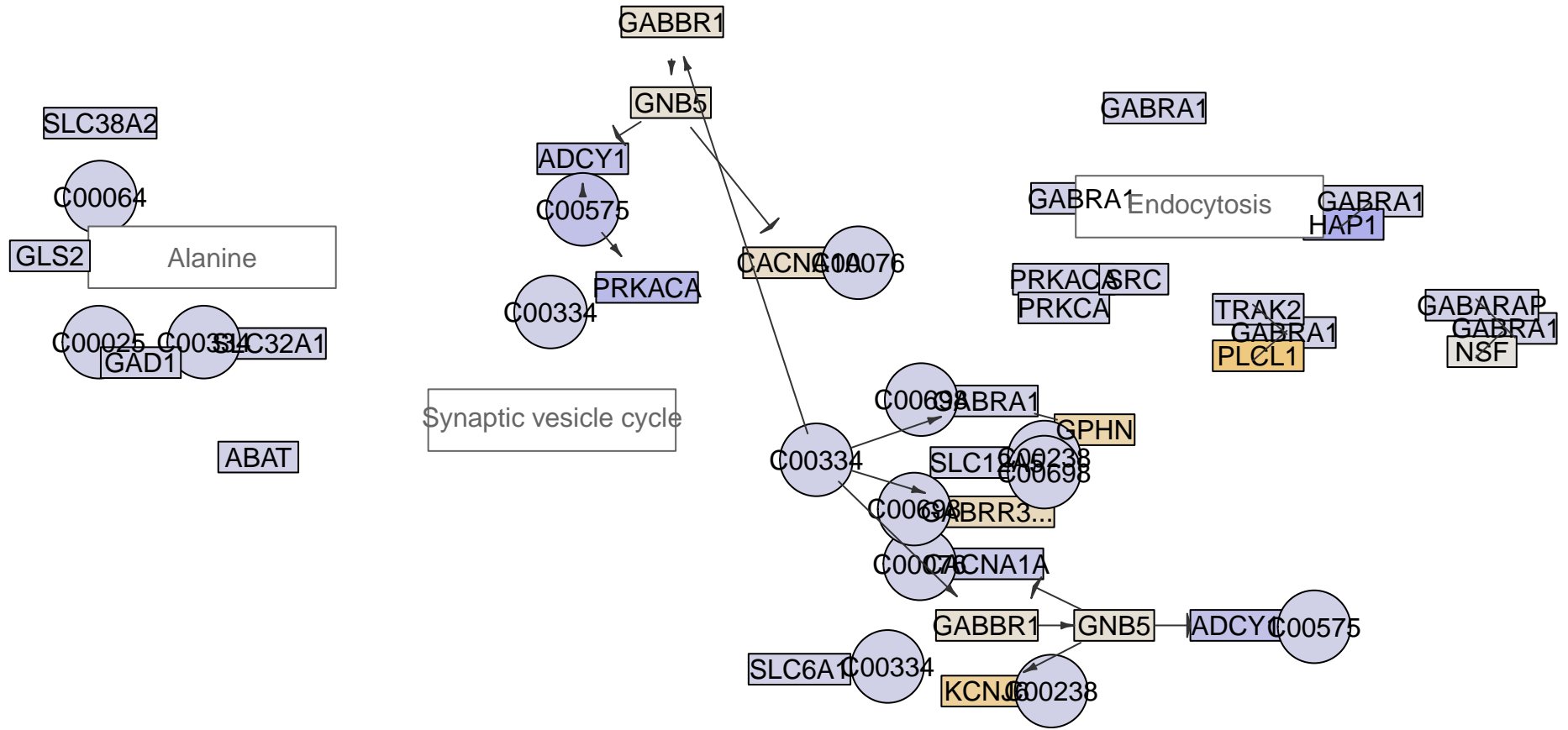

GABAergic synapse
MPI-069

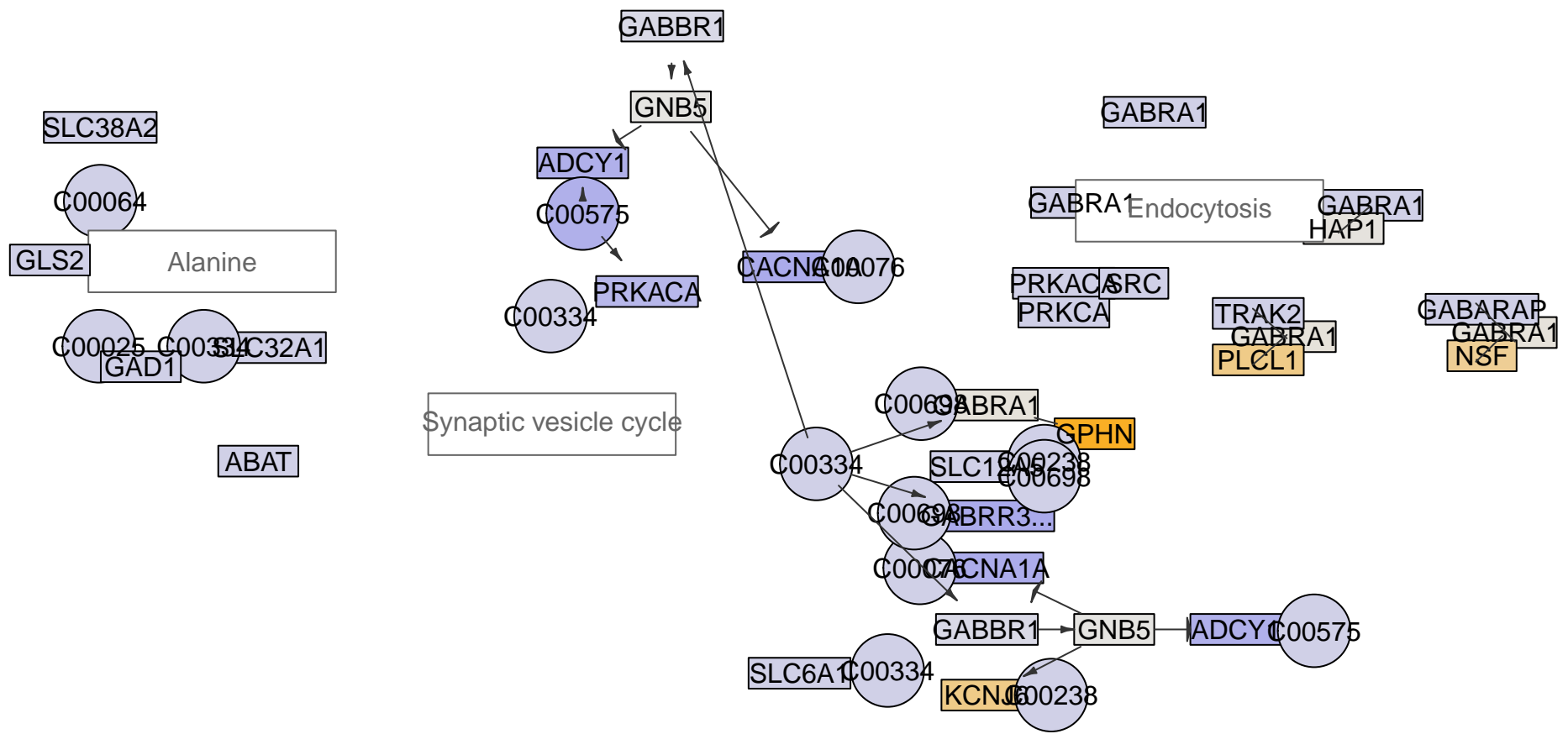

GABAergic synapse
MPI-073

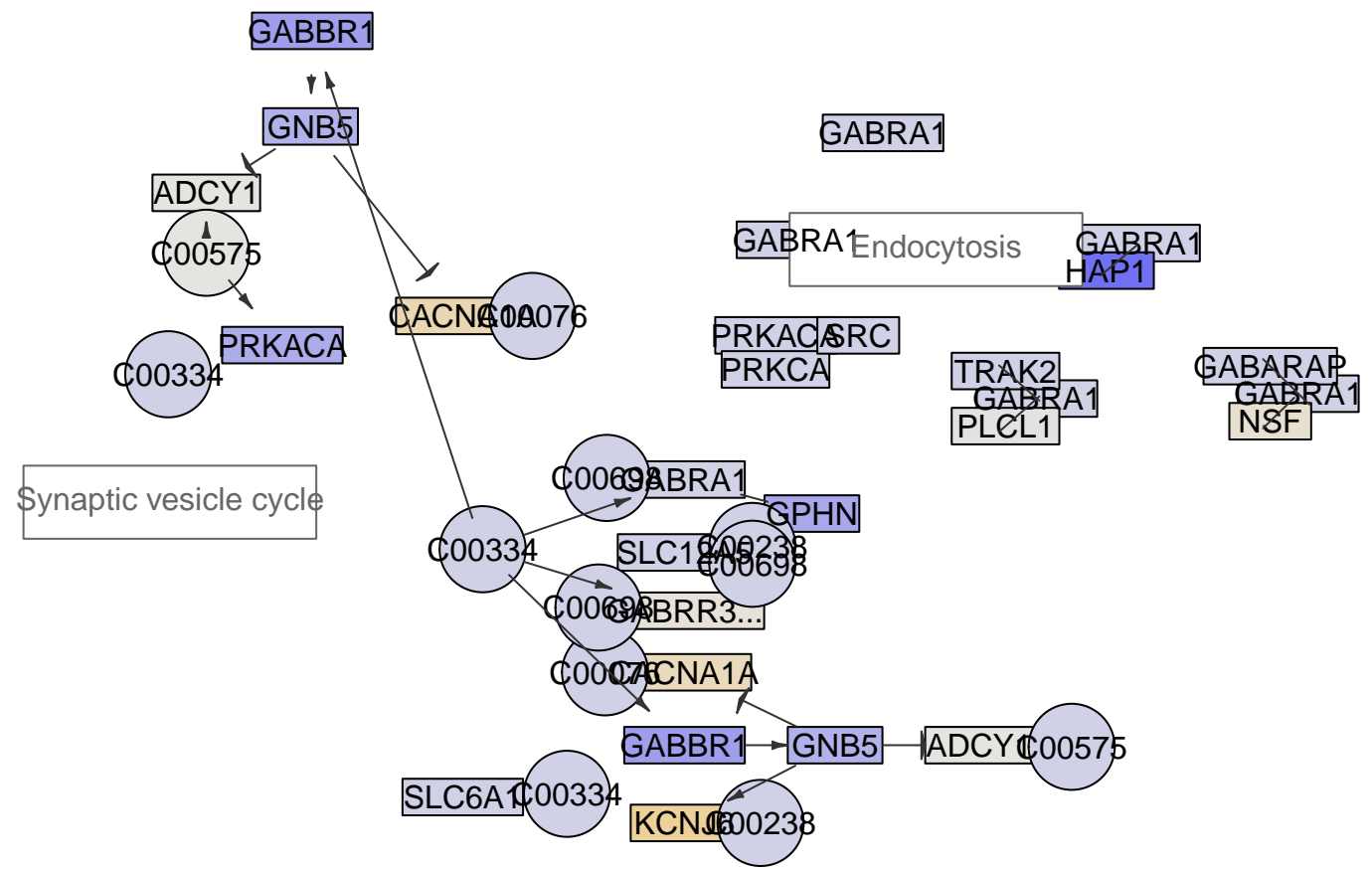
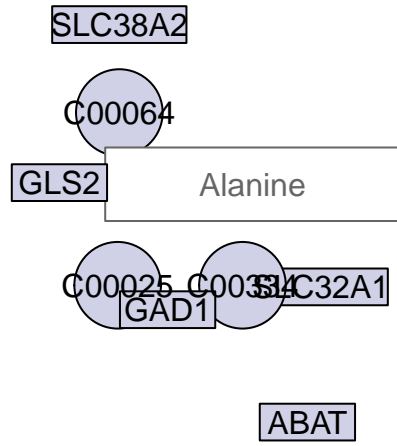

GABAergic synapse
MPI-074

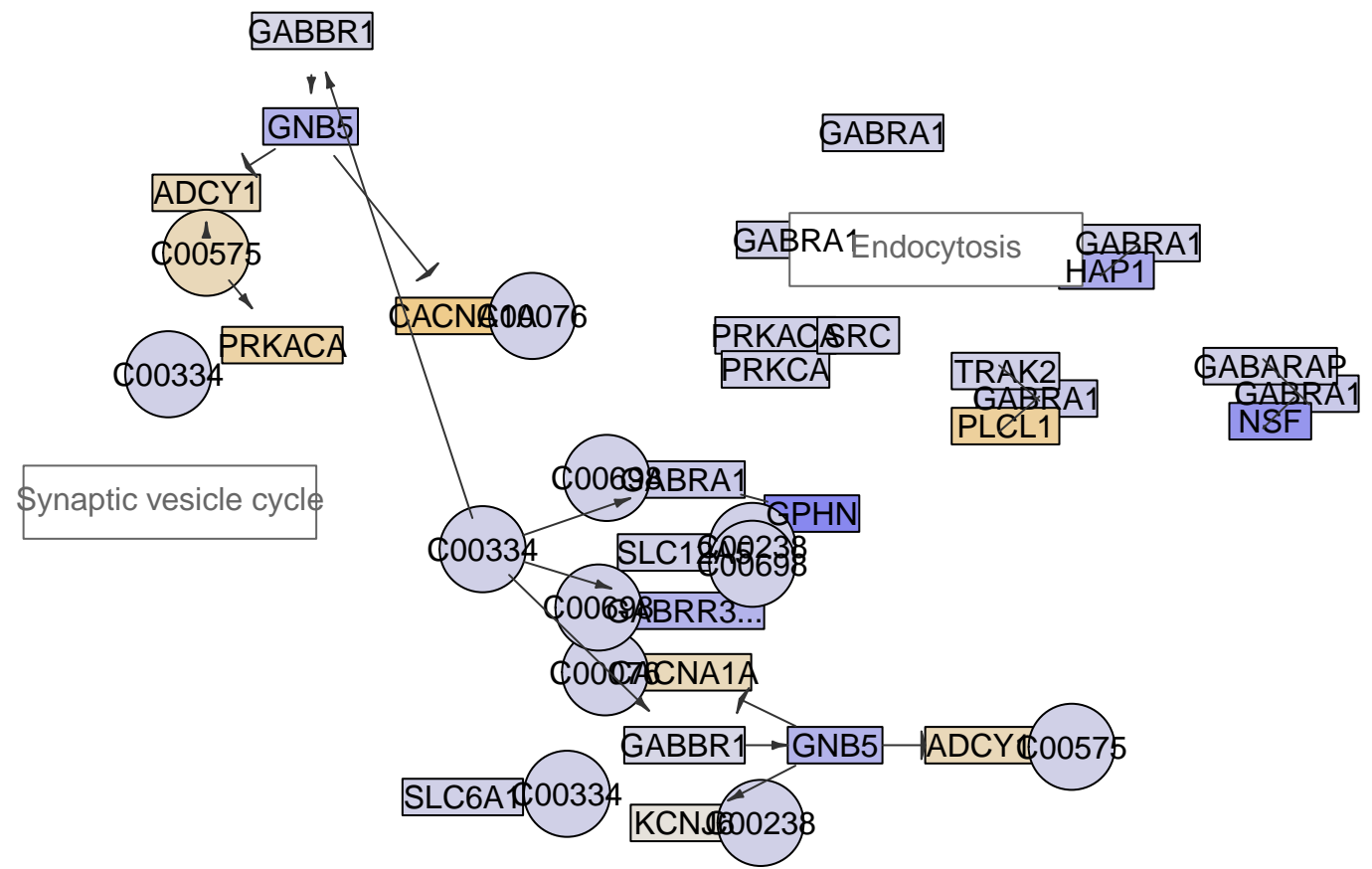
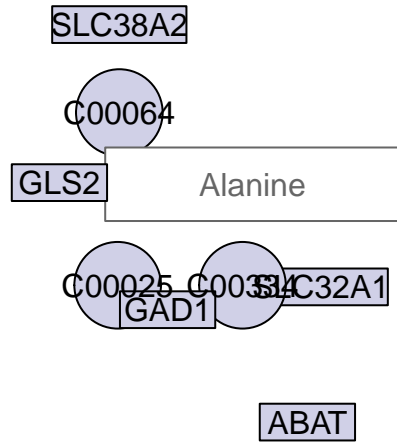

GABAergic synapse
MPI-076

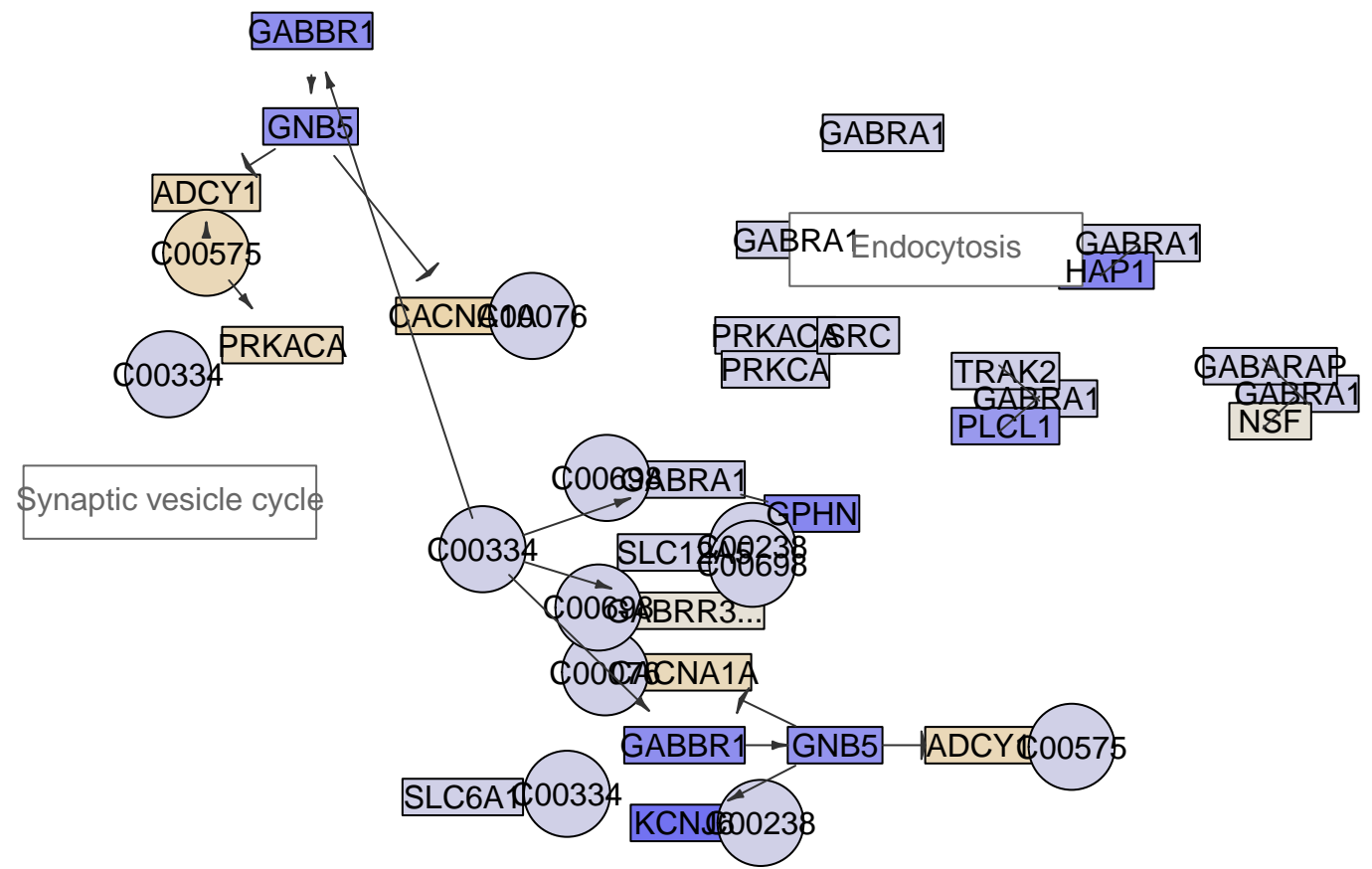
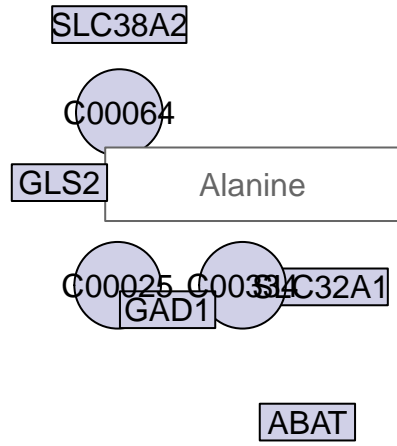

GABAergic synapse
MPI-083

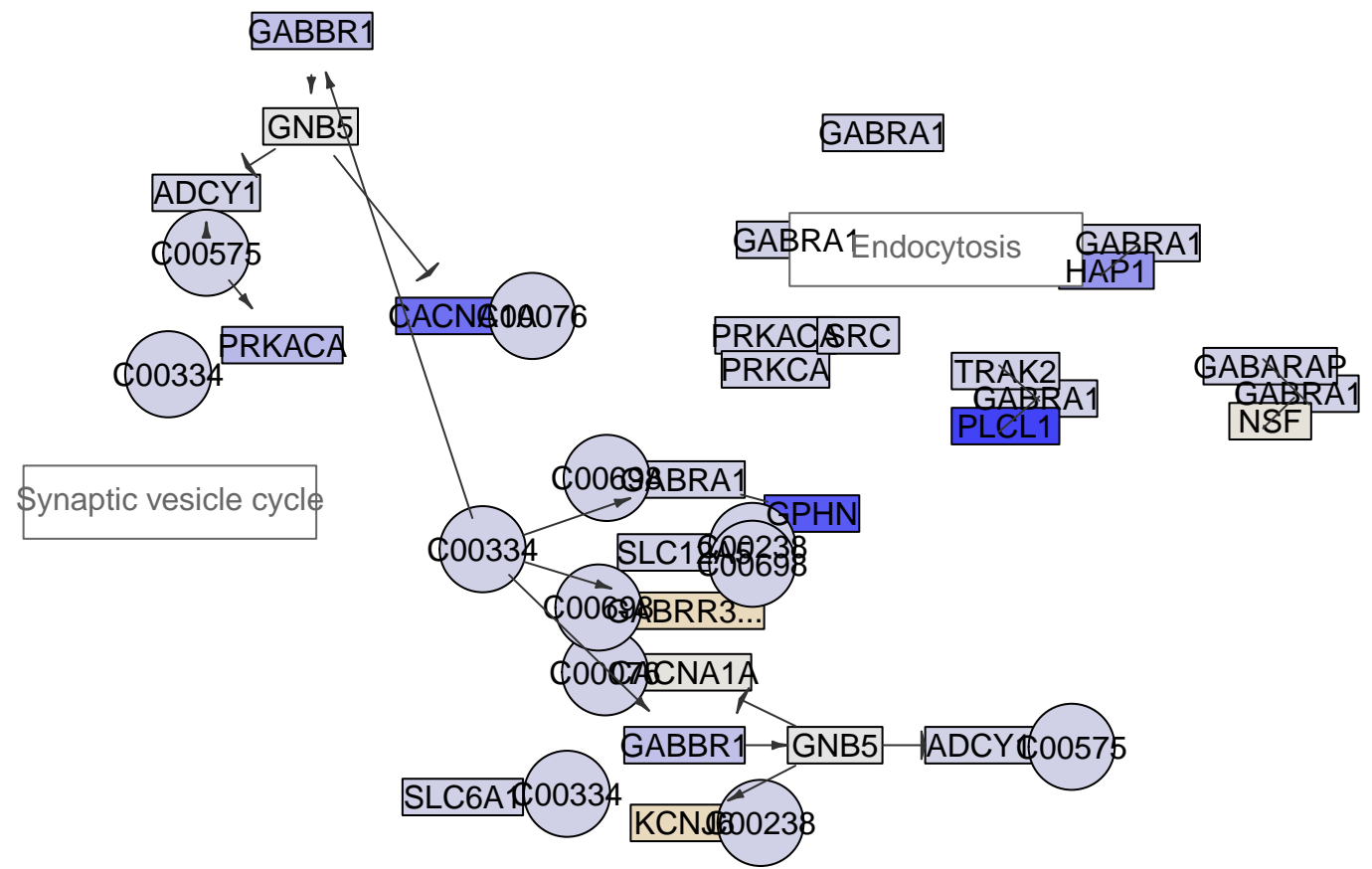
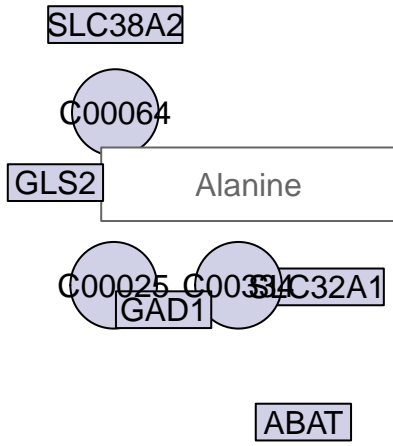

GABAergic synapse
MPI-088

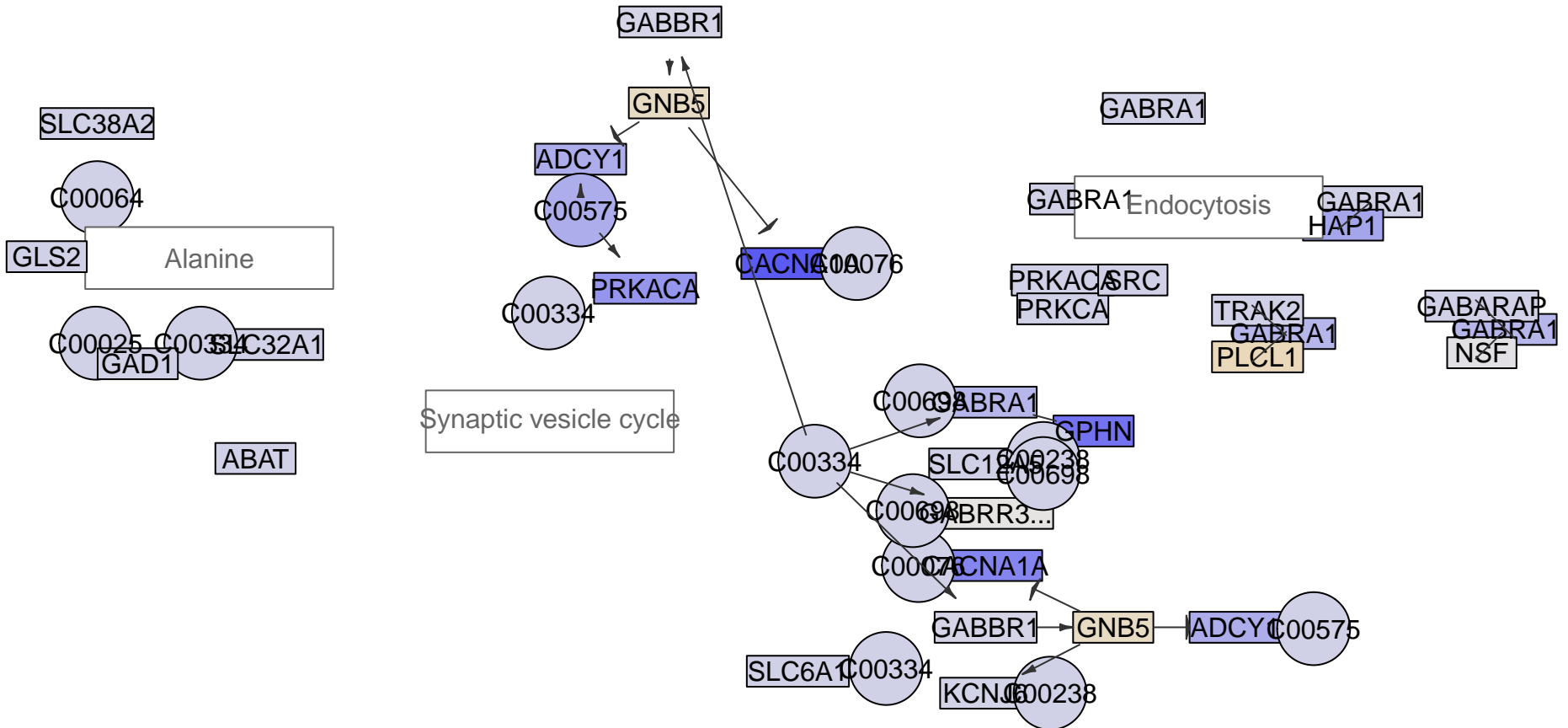
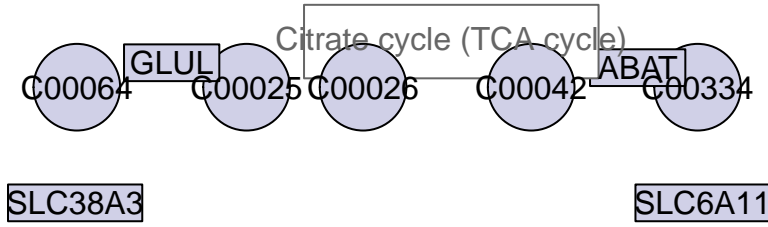

GABAergic synapse
MPI-092

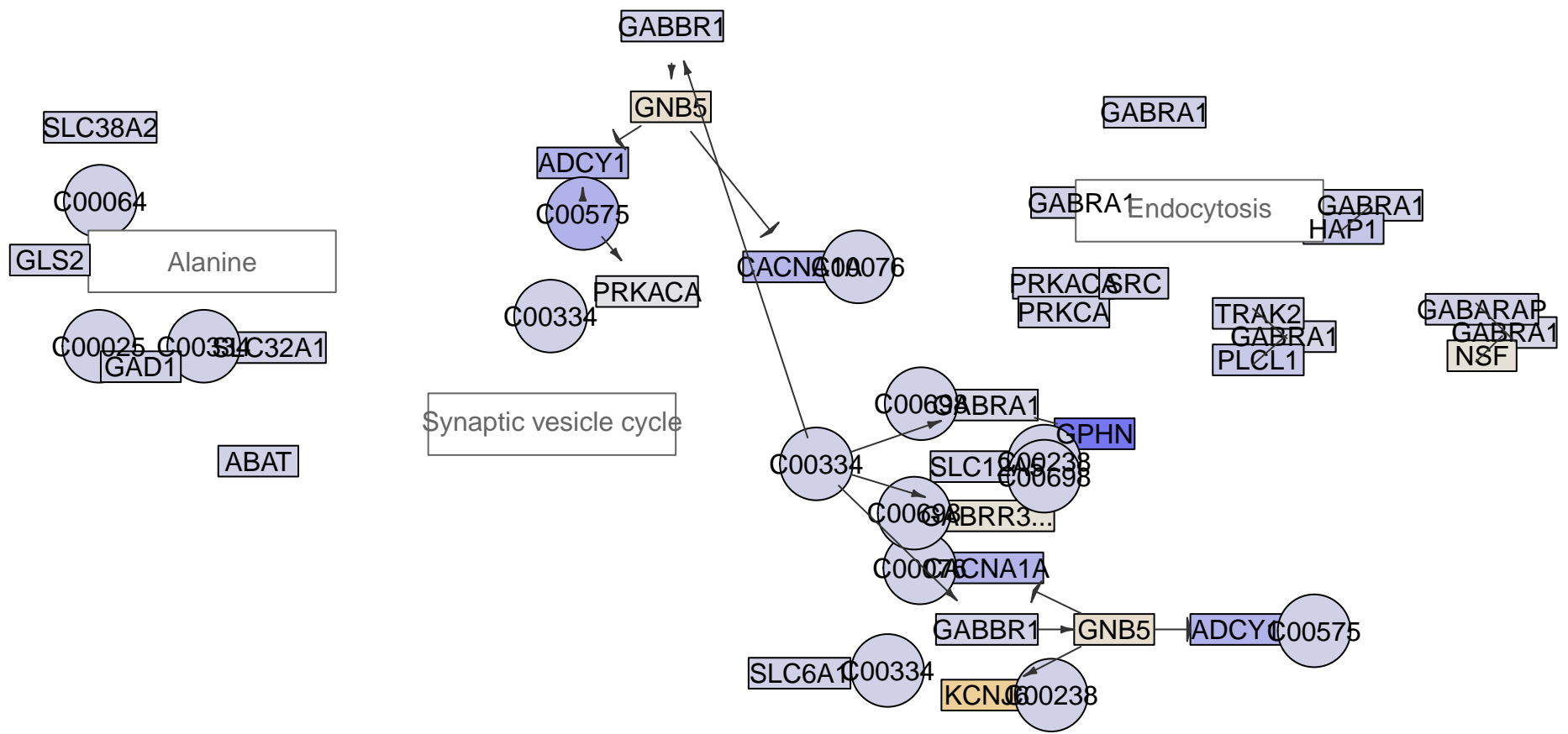

GABAergic synapse
MPI-096

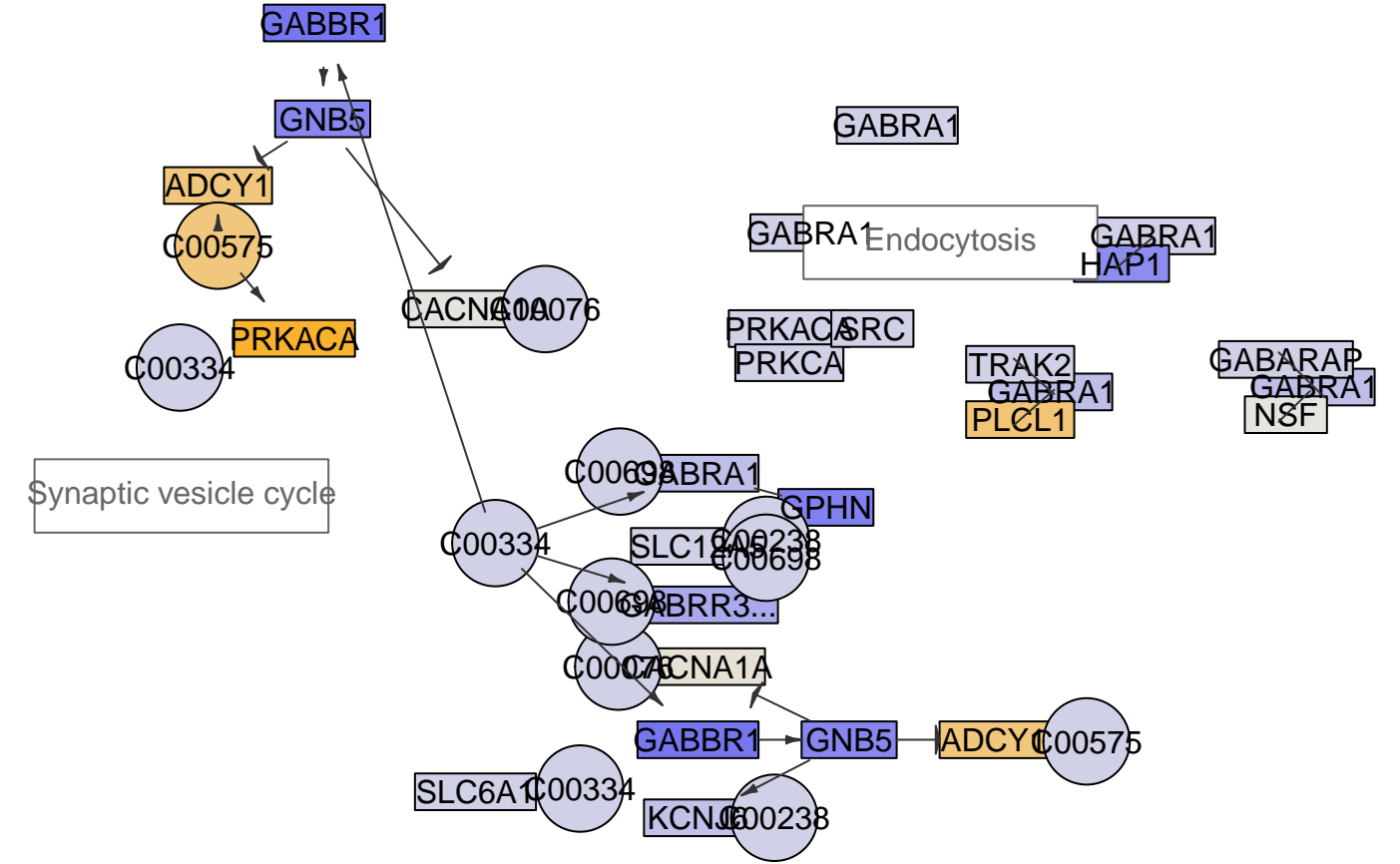
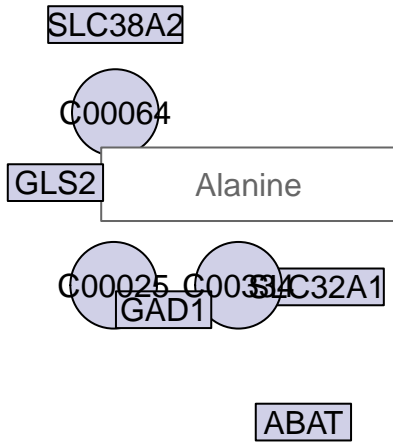

GABAergic synapse
MPI-098

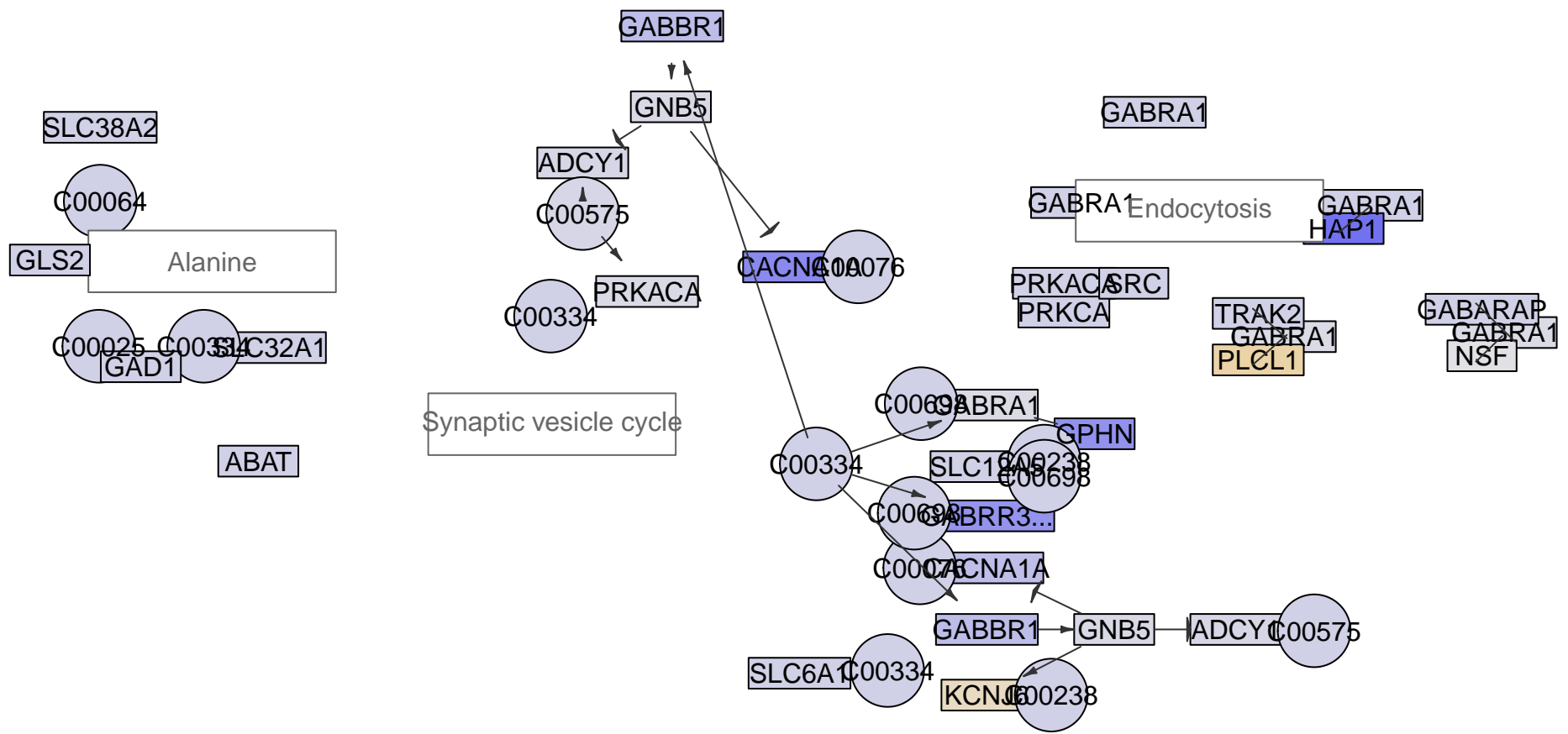

GABAergic synapse
MPI-100

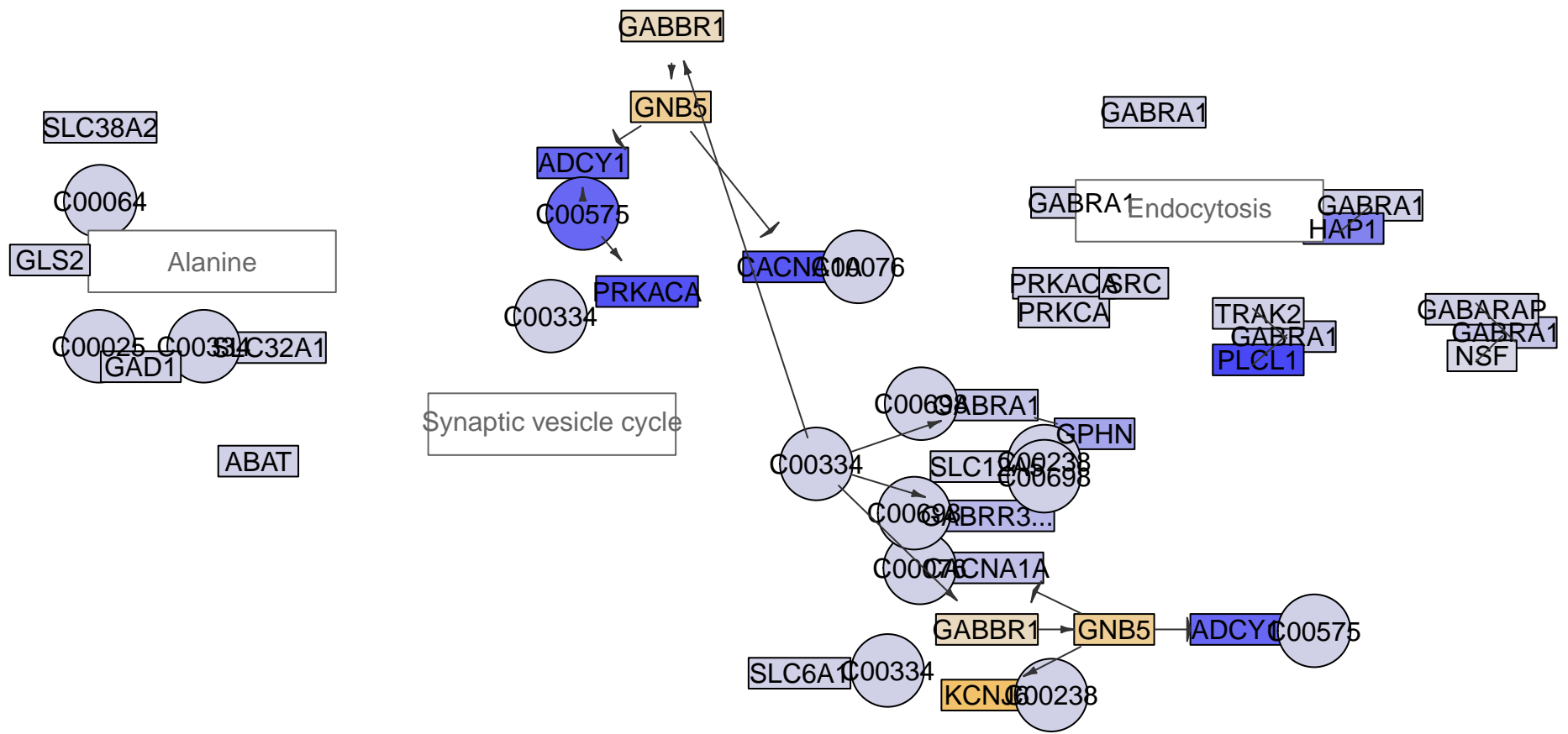

GABAergic synapse
MPI-105

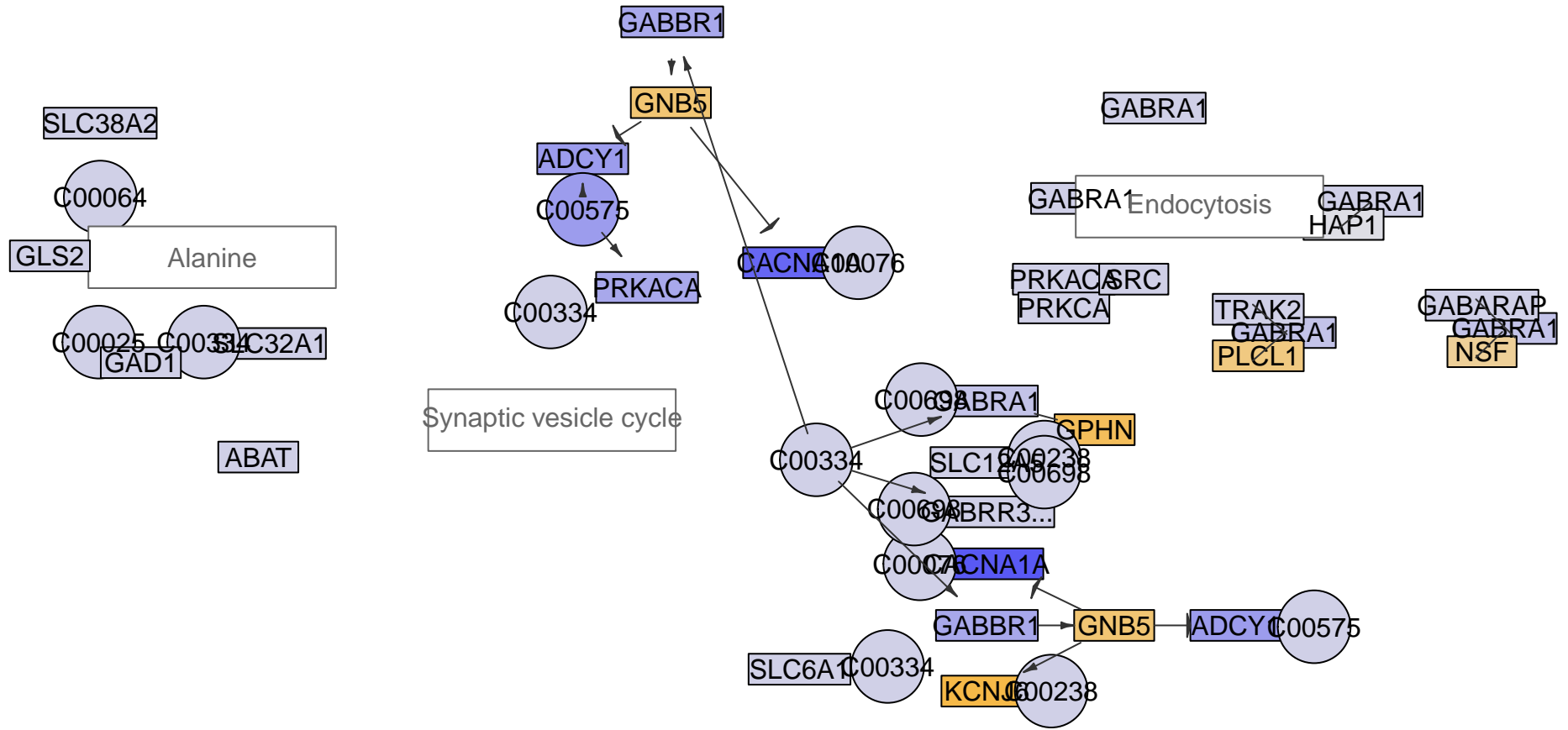

GABAergic synapse
MPI-106

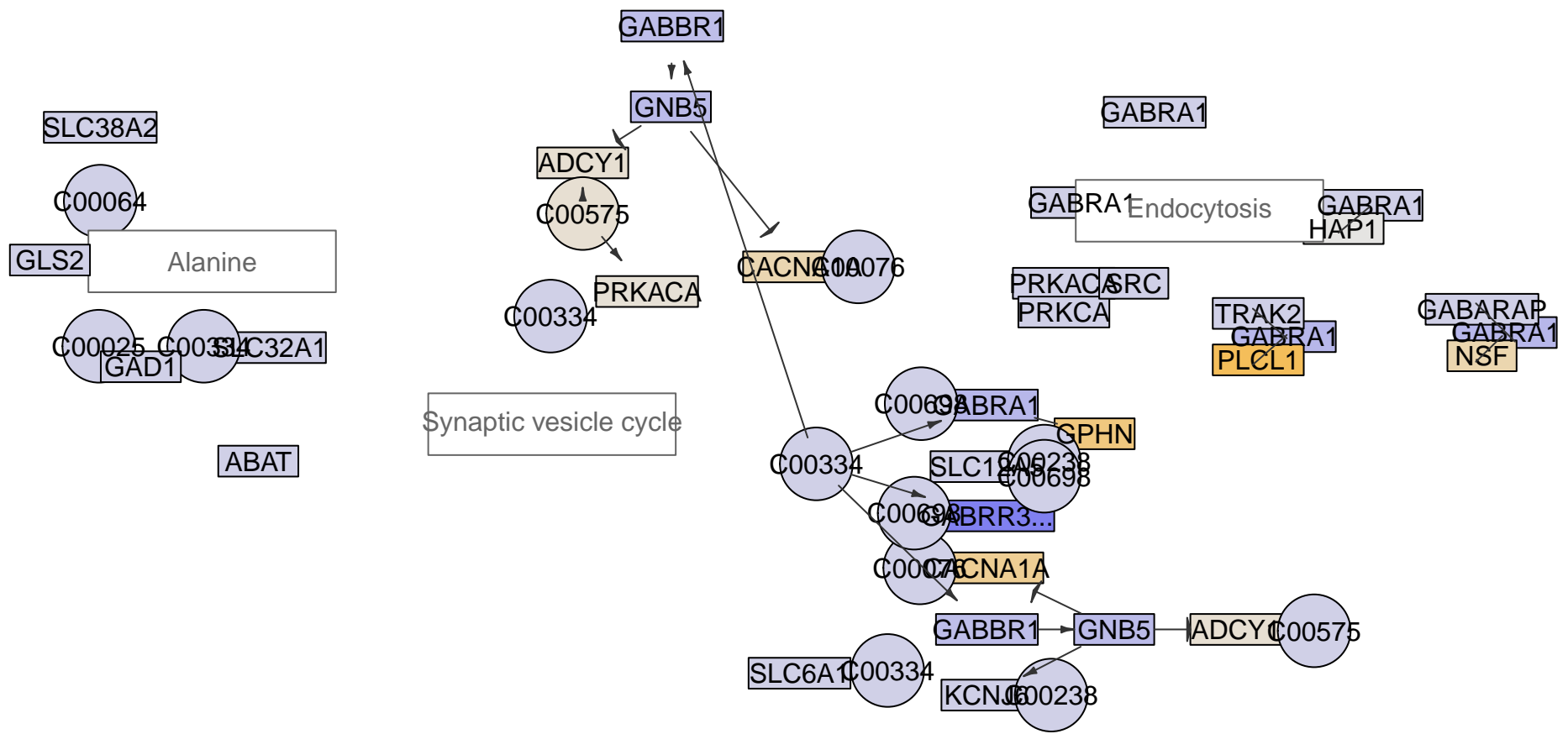

GABAergic synapse
MPI-108

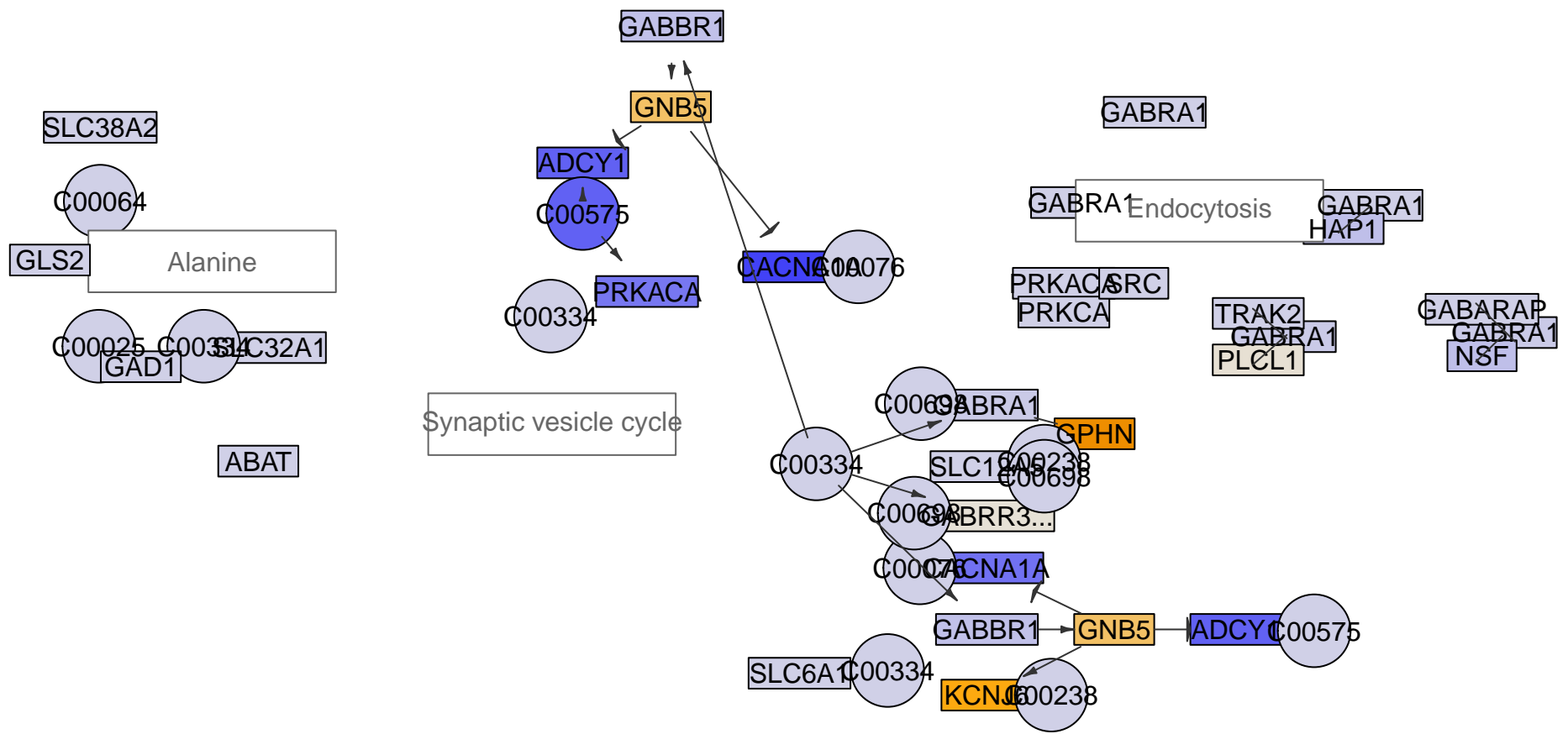

GABAergic synapse
MPI-109

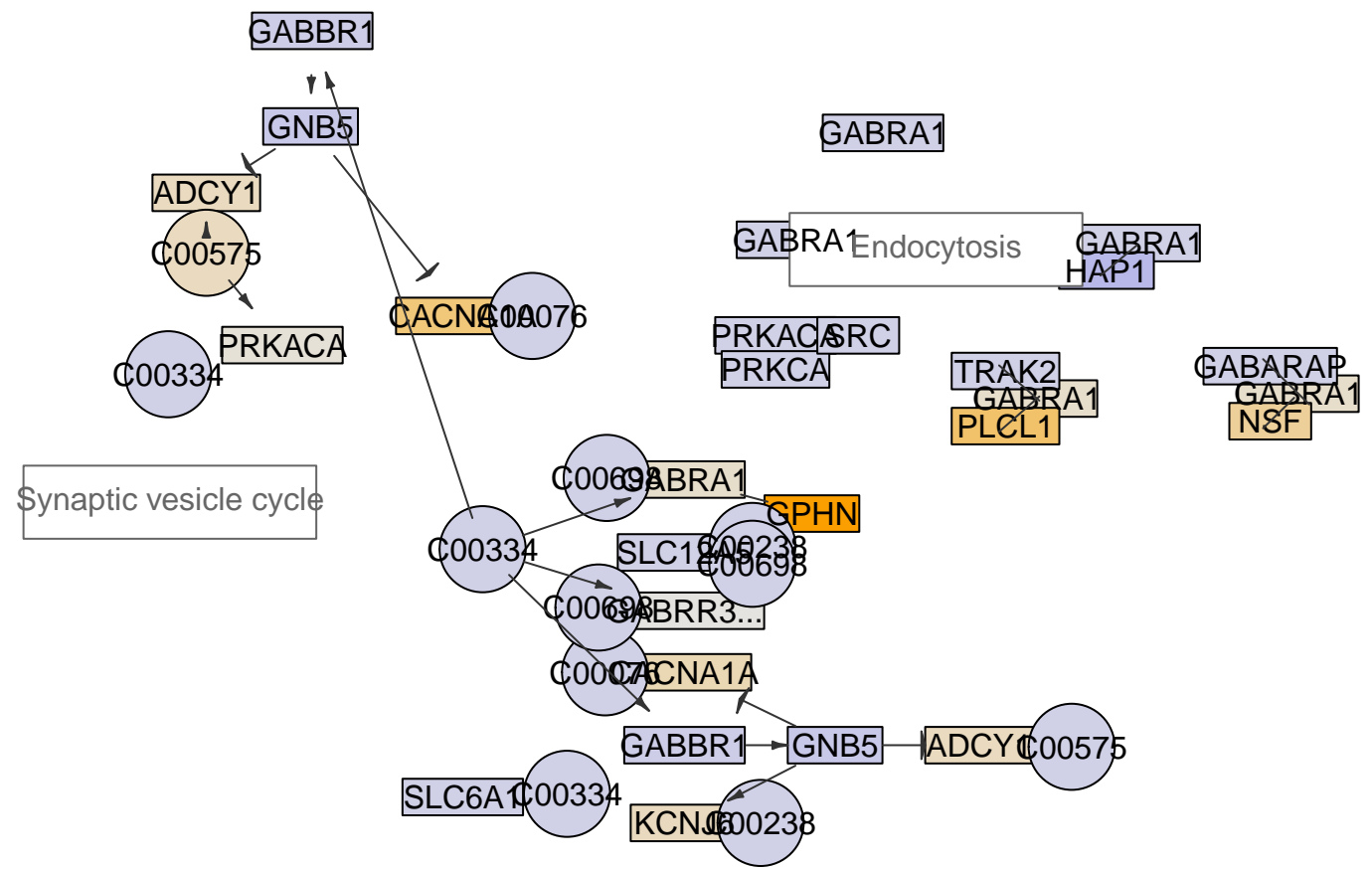
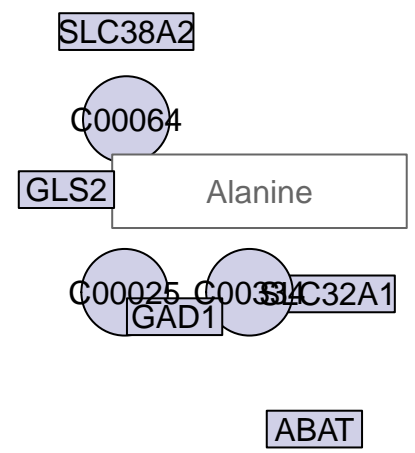

GABAergic synapse
MPI-110

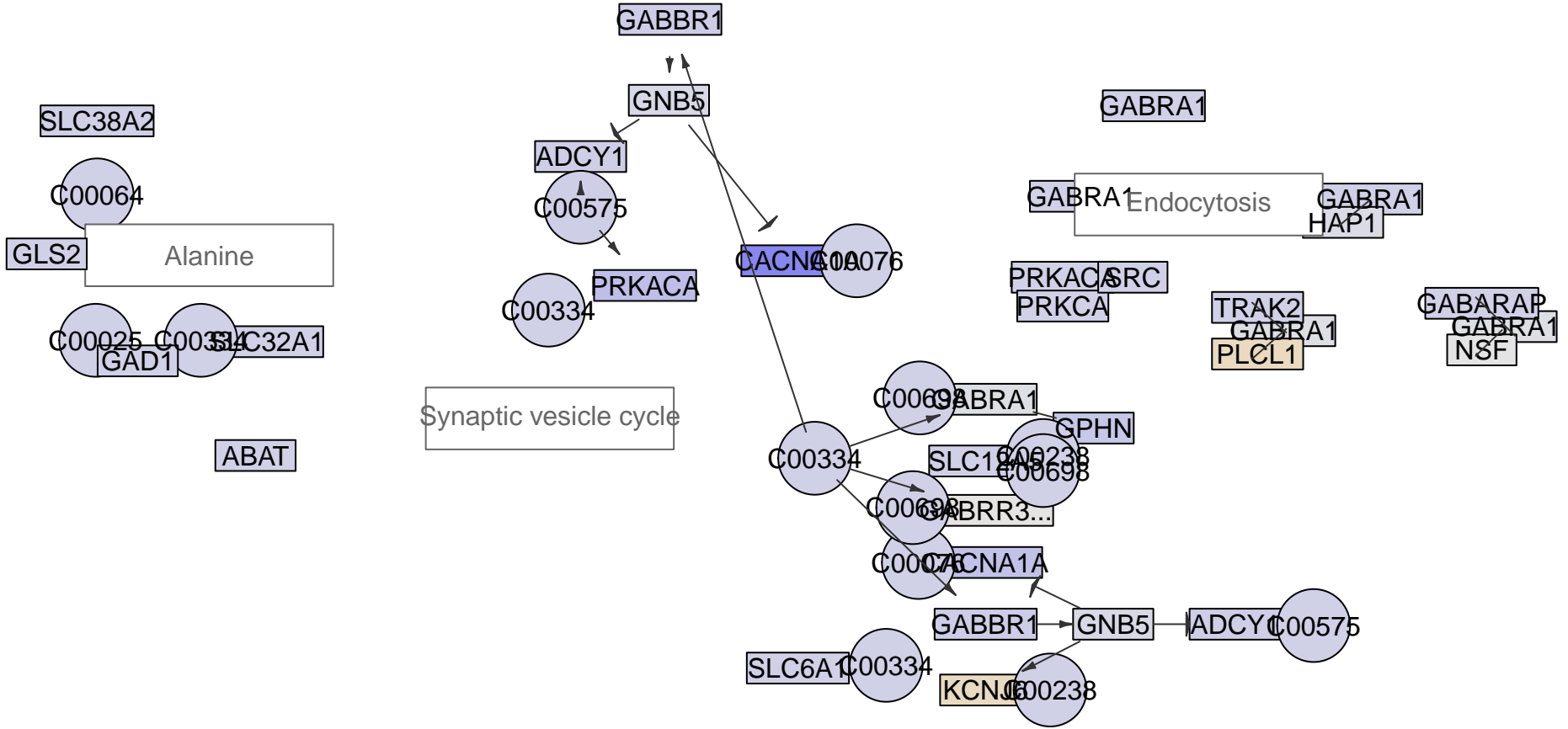

GABAergic synapse MPI-111

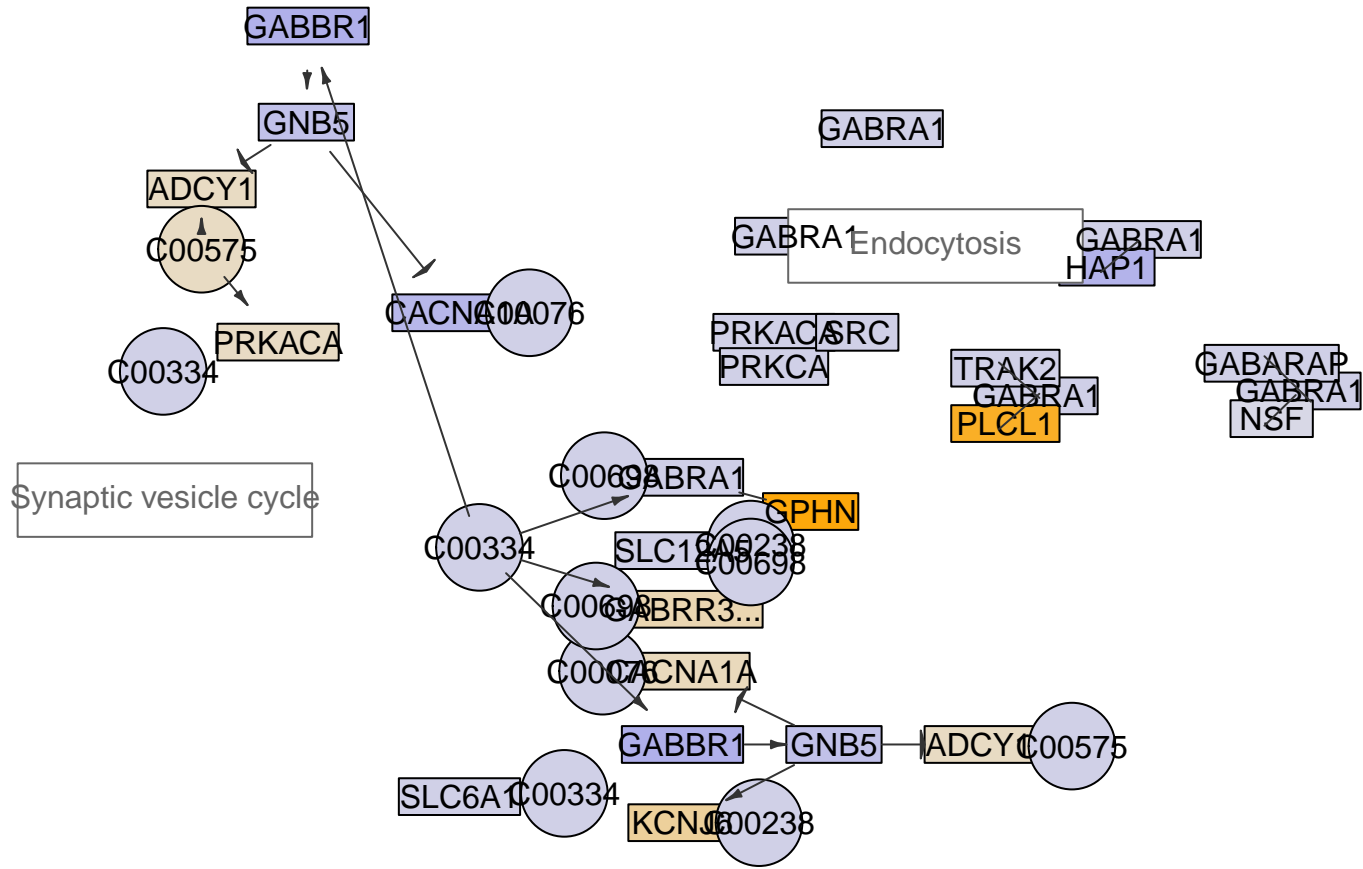
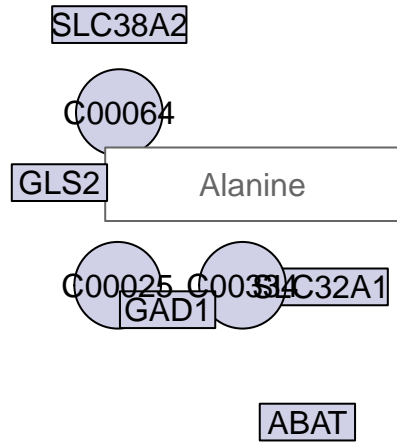

GABAergic synapse
MPI-113

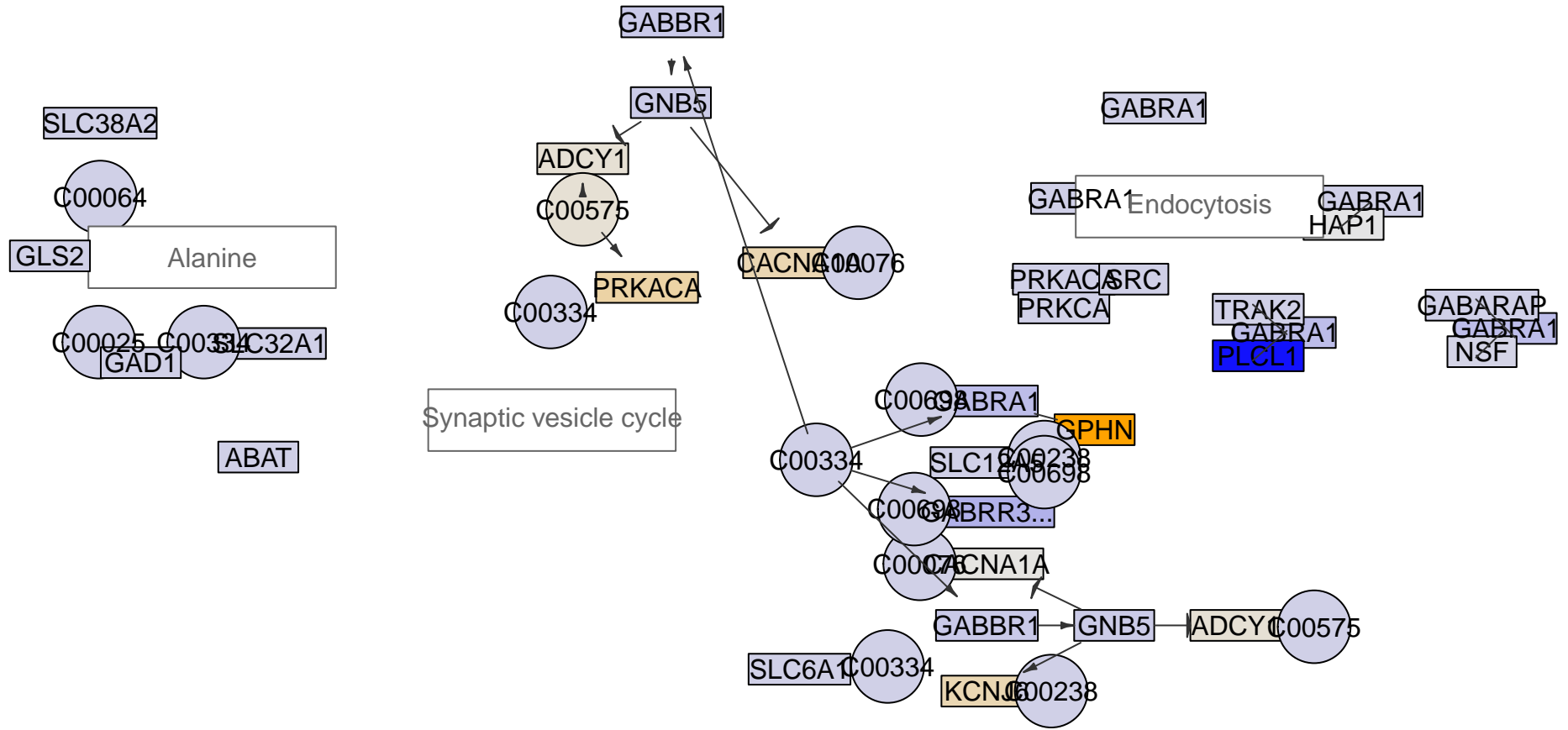

GABAergic synapse
MPI-115

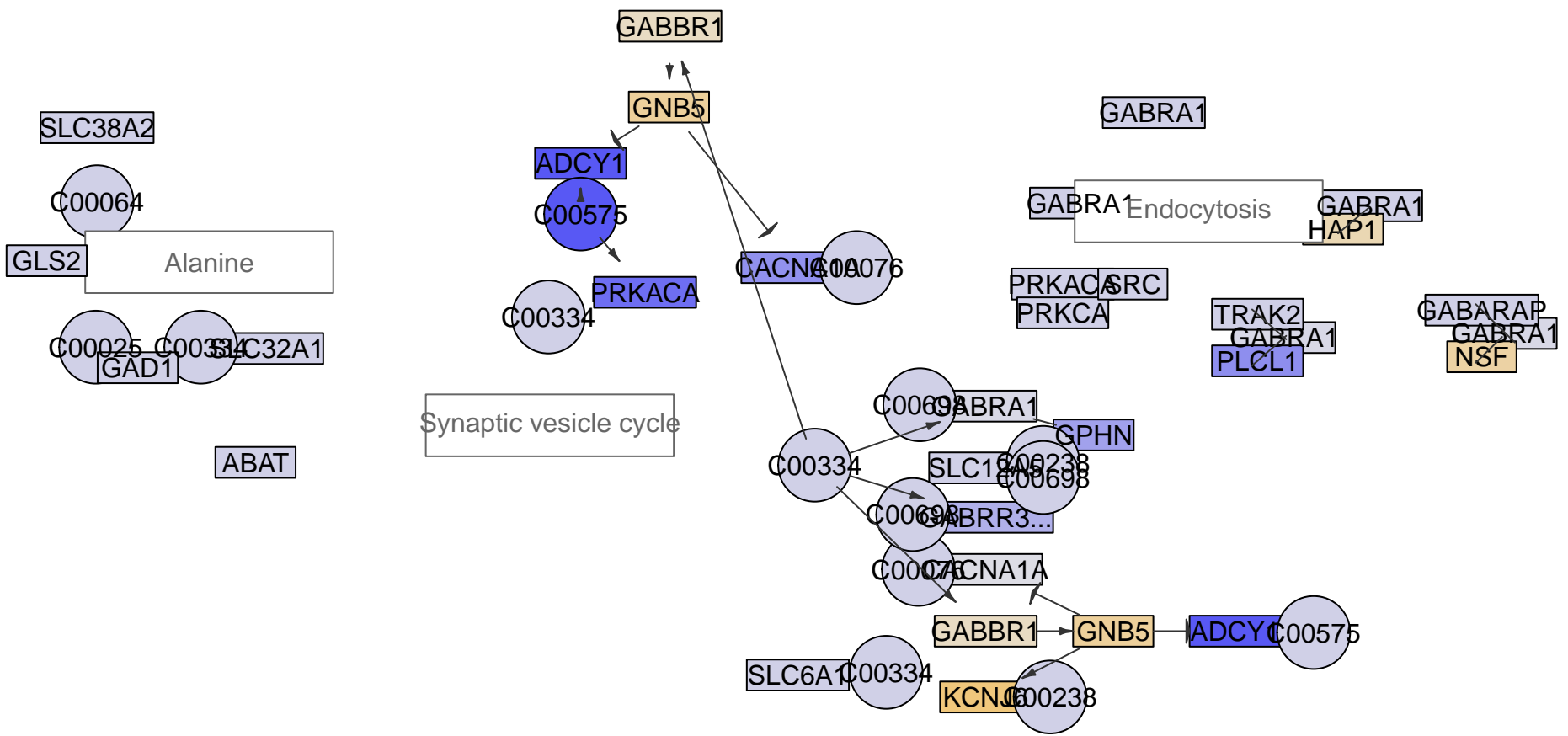

GABAergic synapse
MPI-118

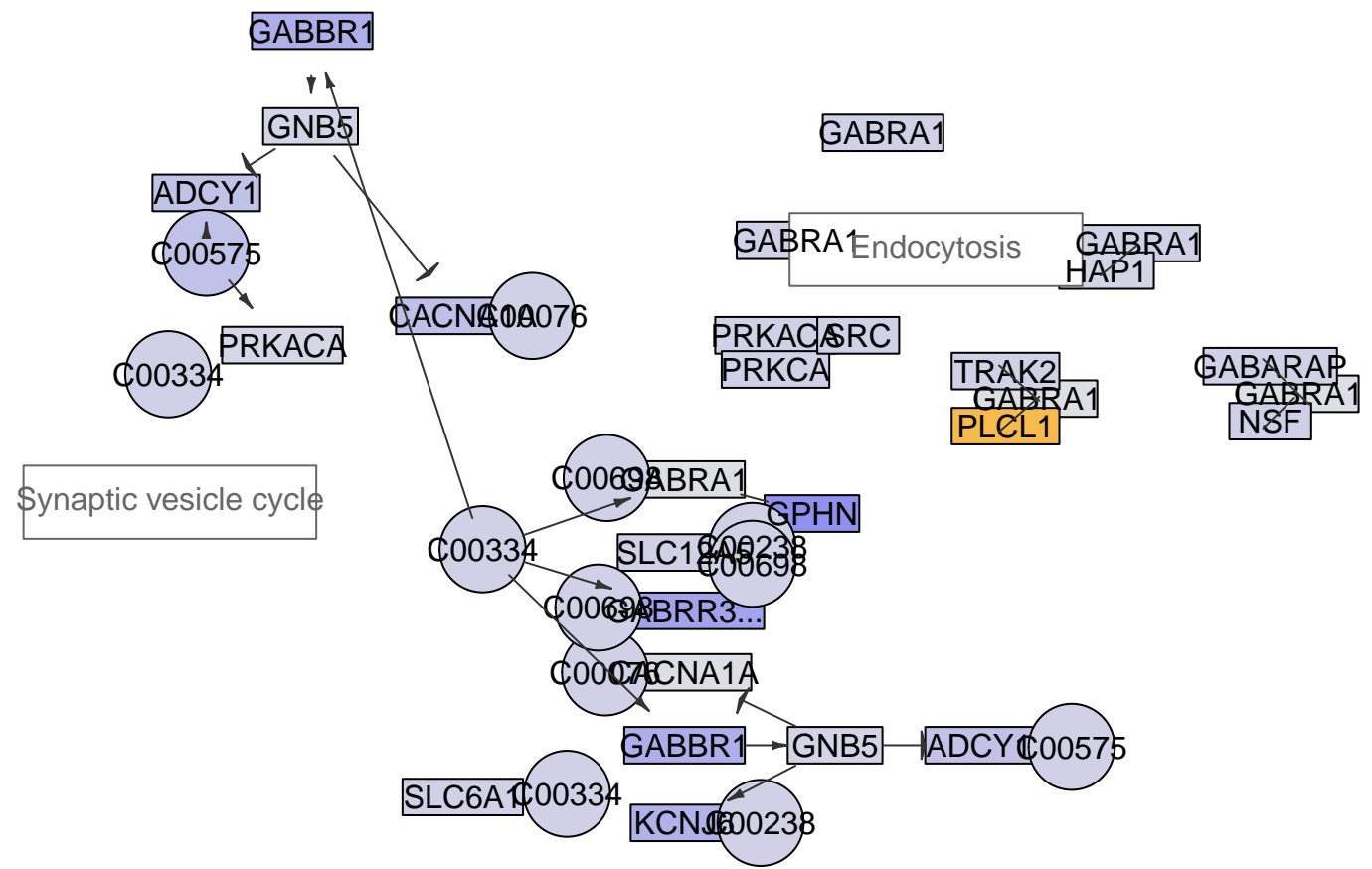
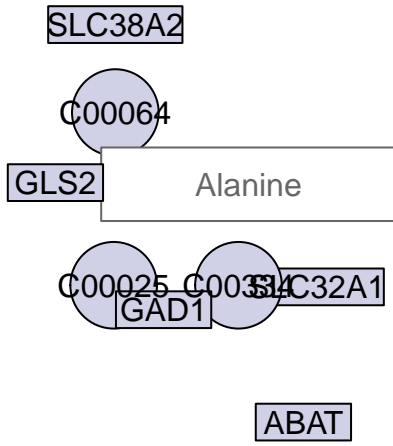

GABAergic synapse
MPI-119

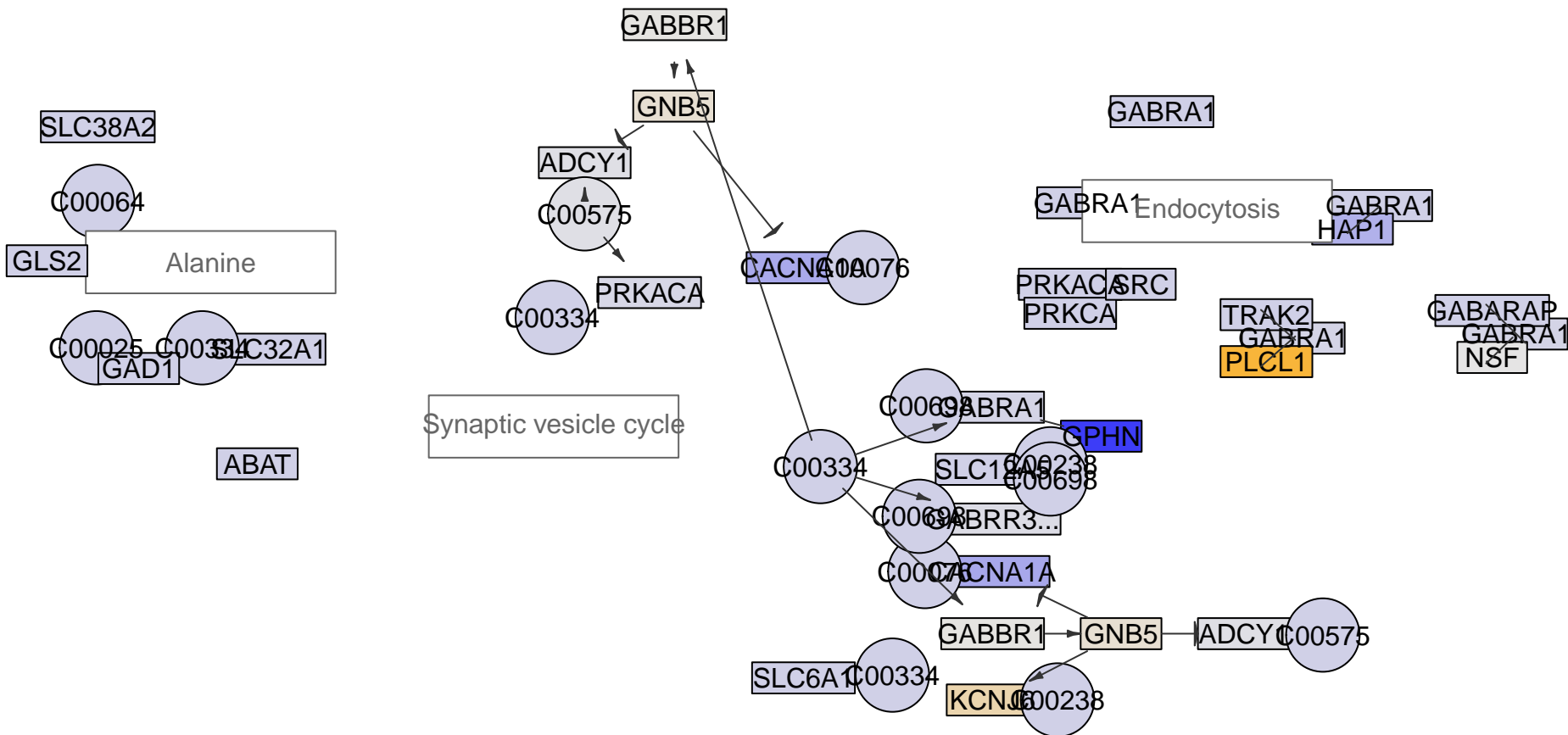
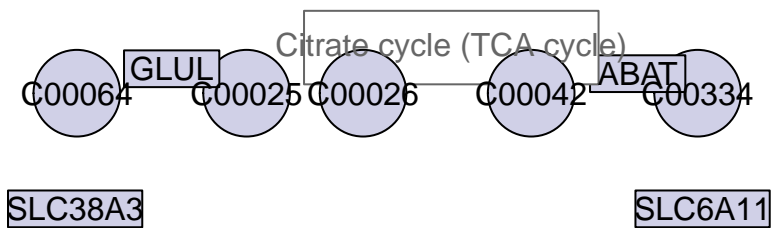

GABAergic synapse
MPI-122

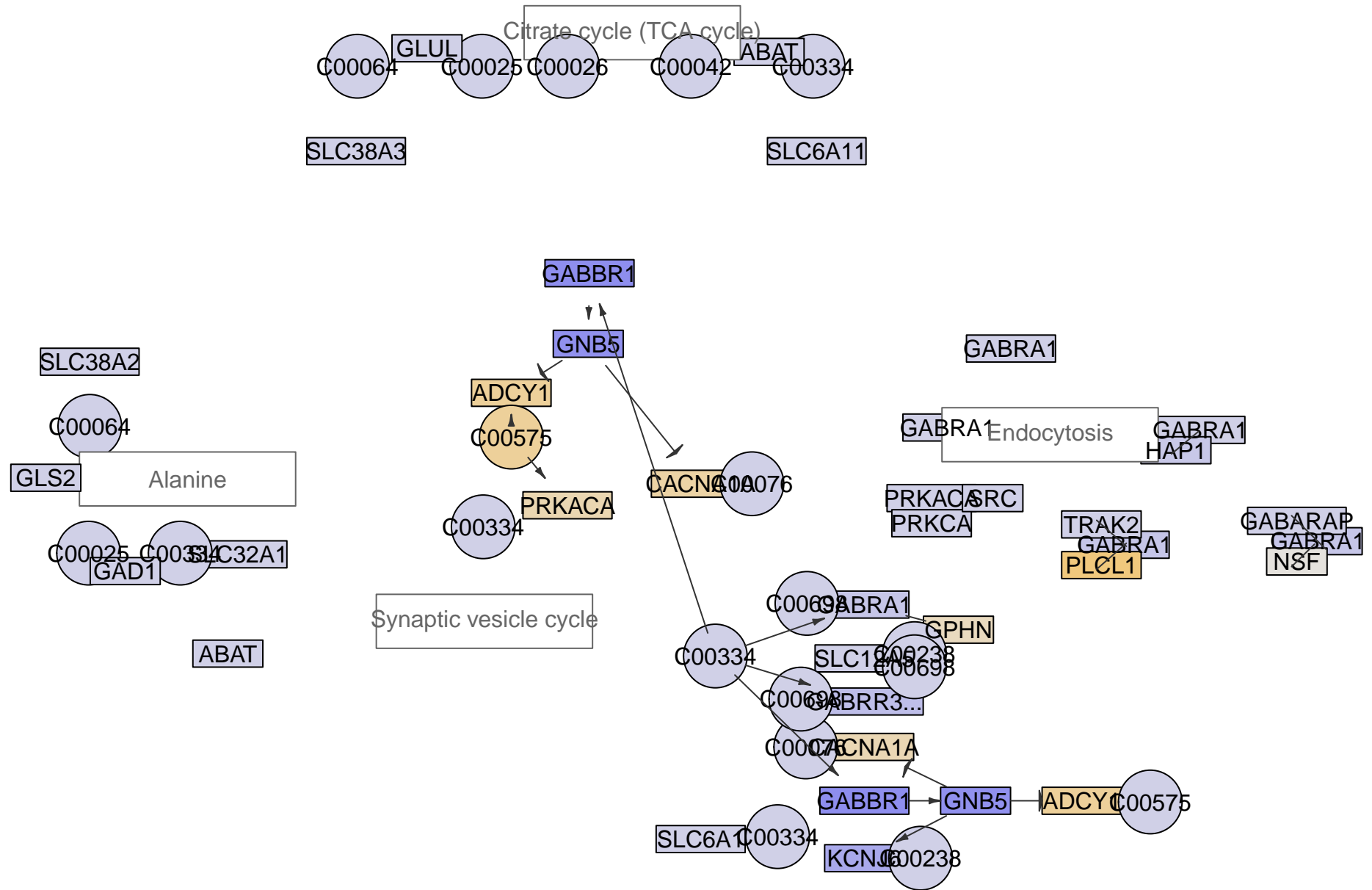

GABAergic synapse
MPI-127

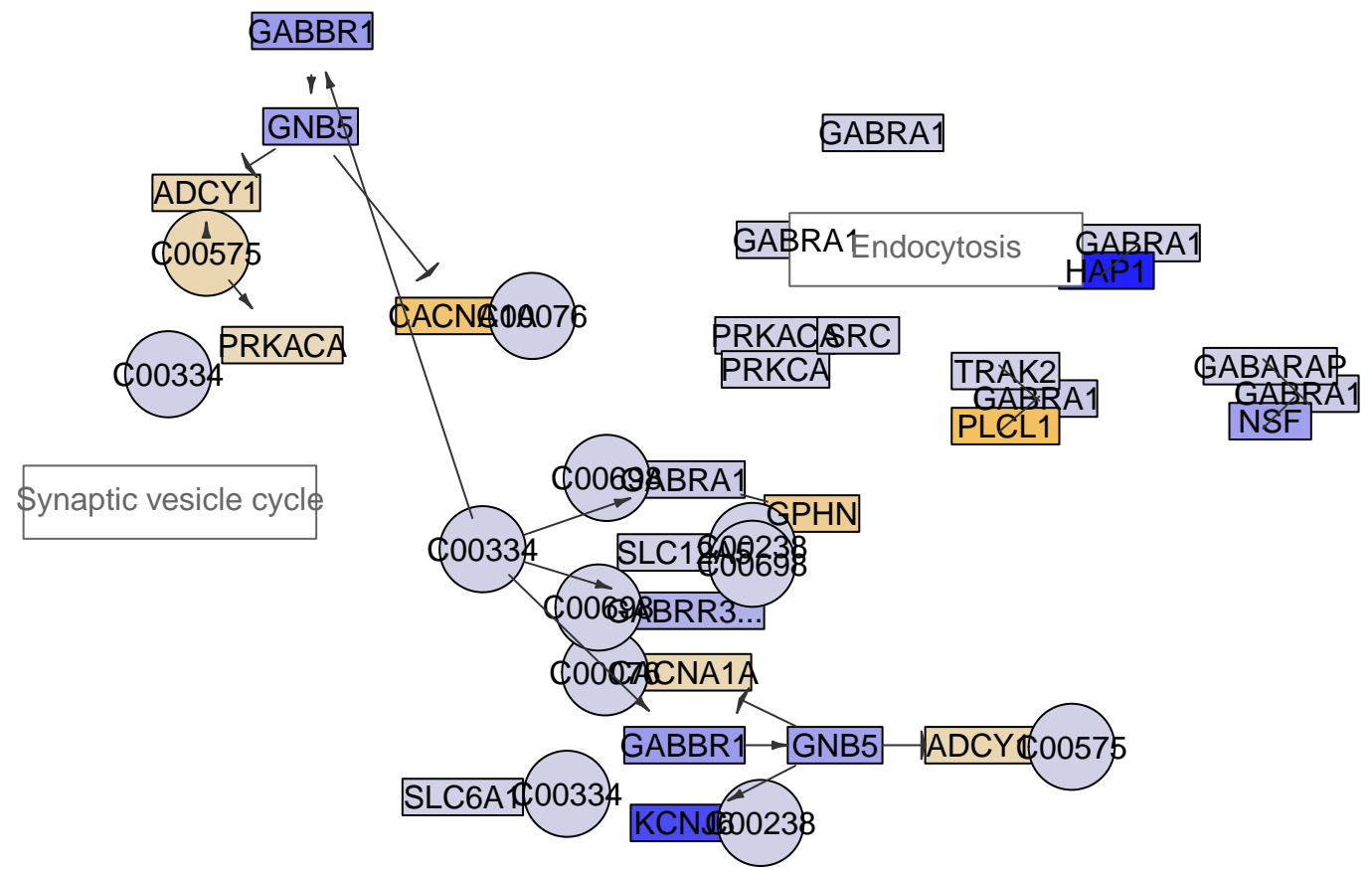
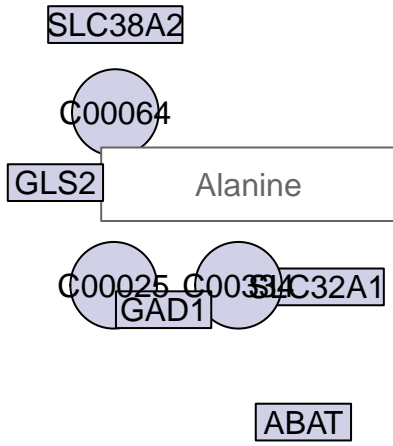

GABAergic synapse
MPI-128

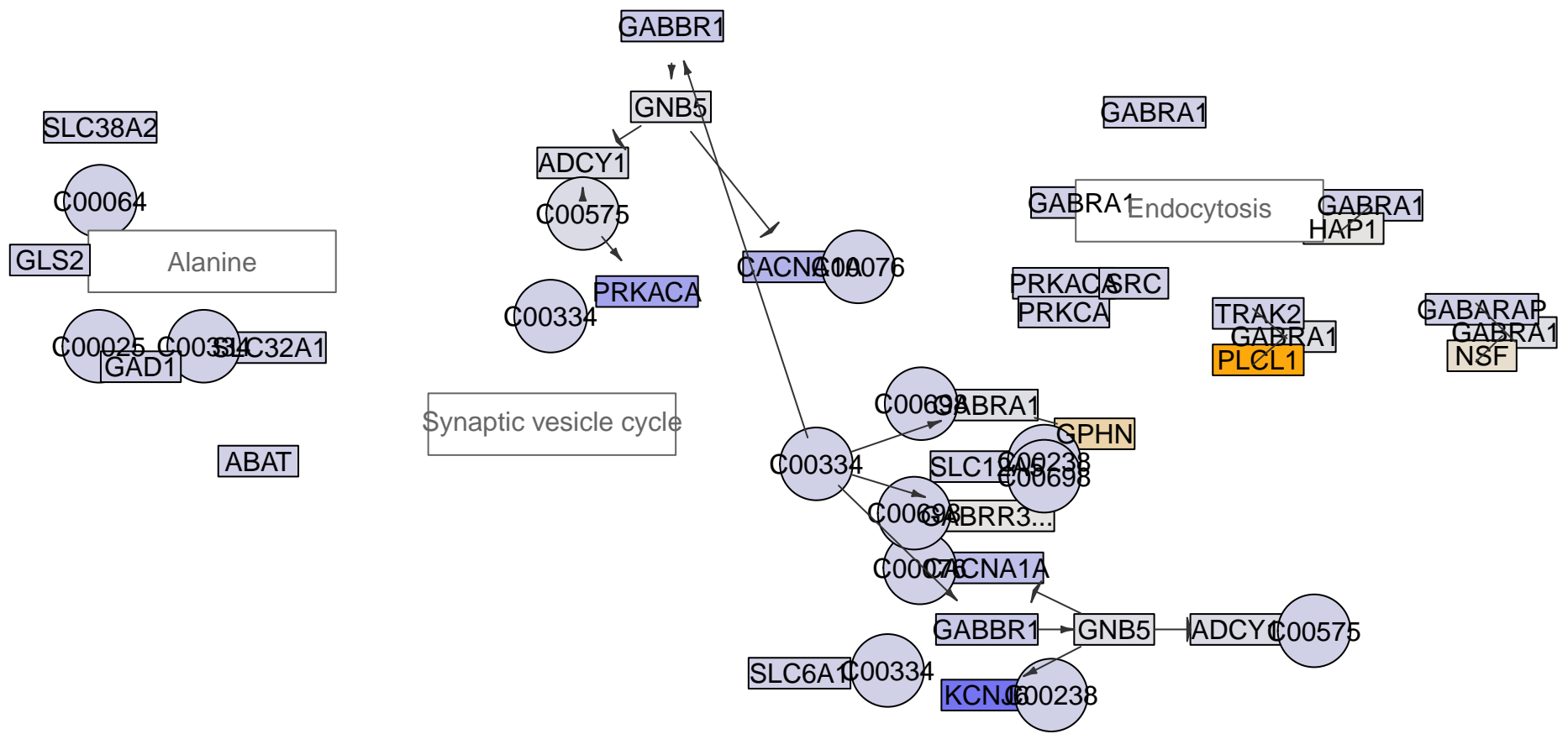

GABAergic synapse
MPI-129

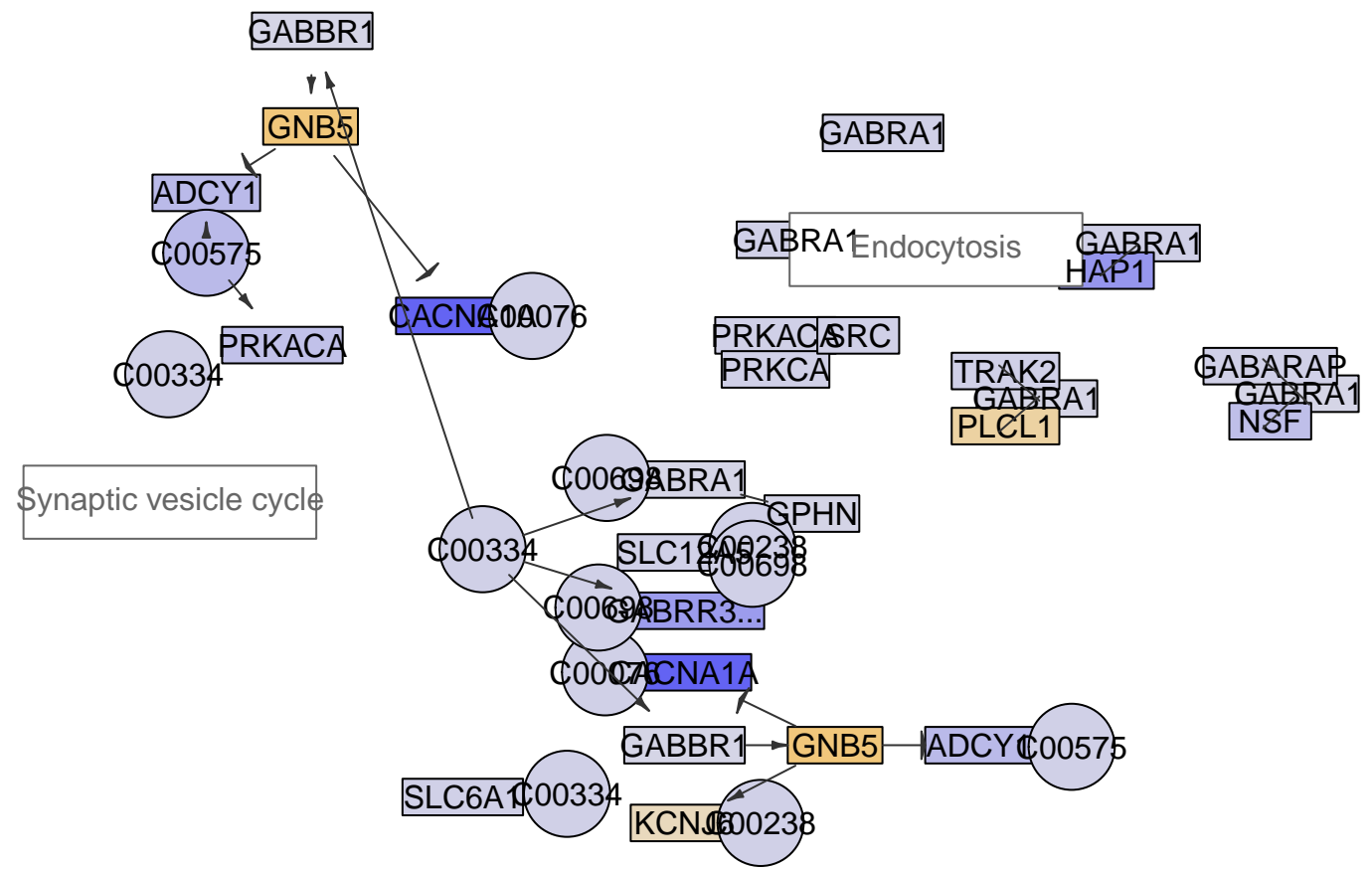
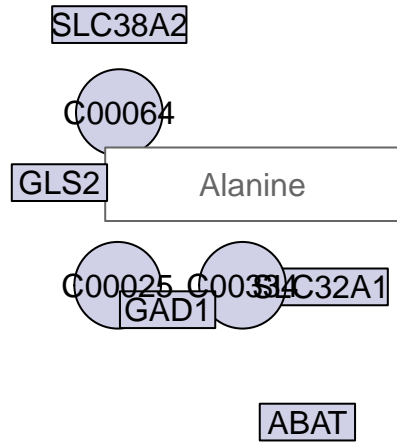

GABAergic synapse
MPI-130

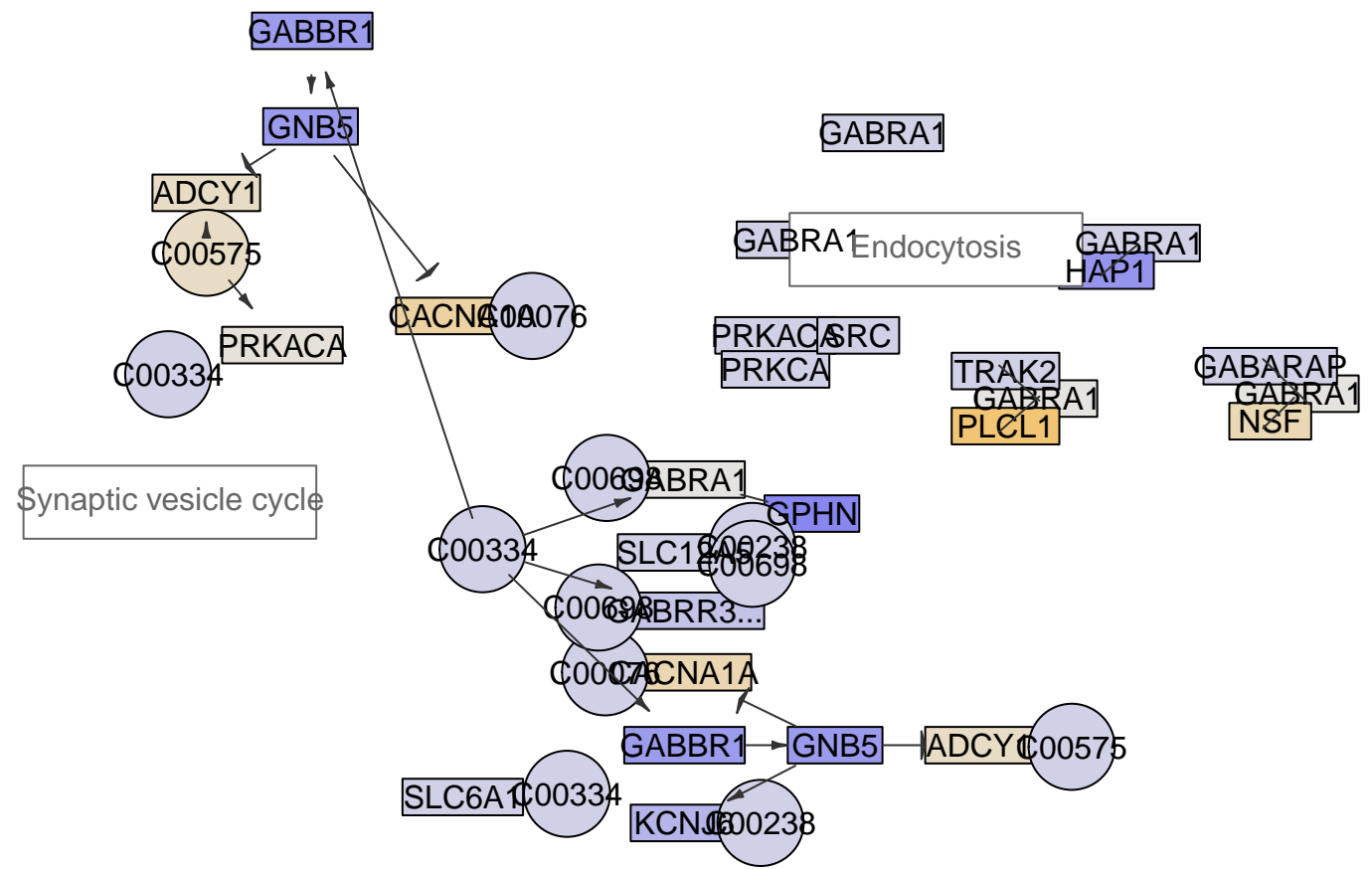
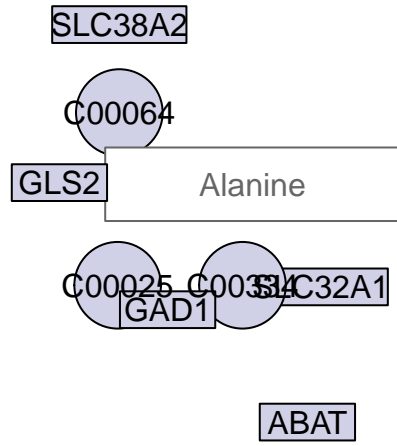

GABAergic synapse
MPI-132

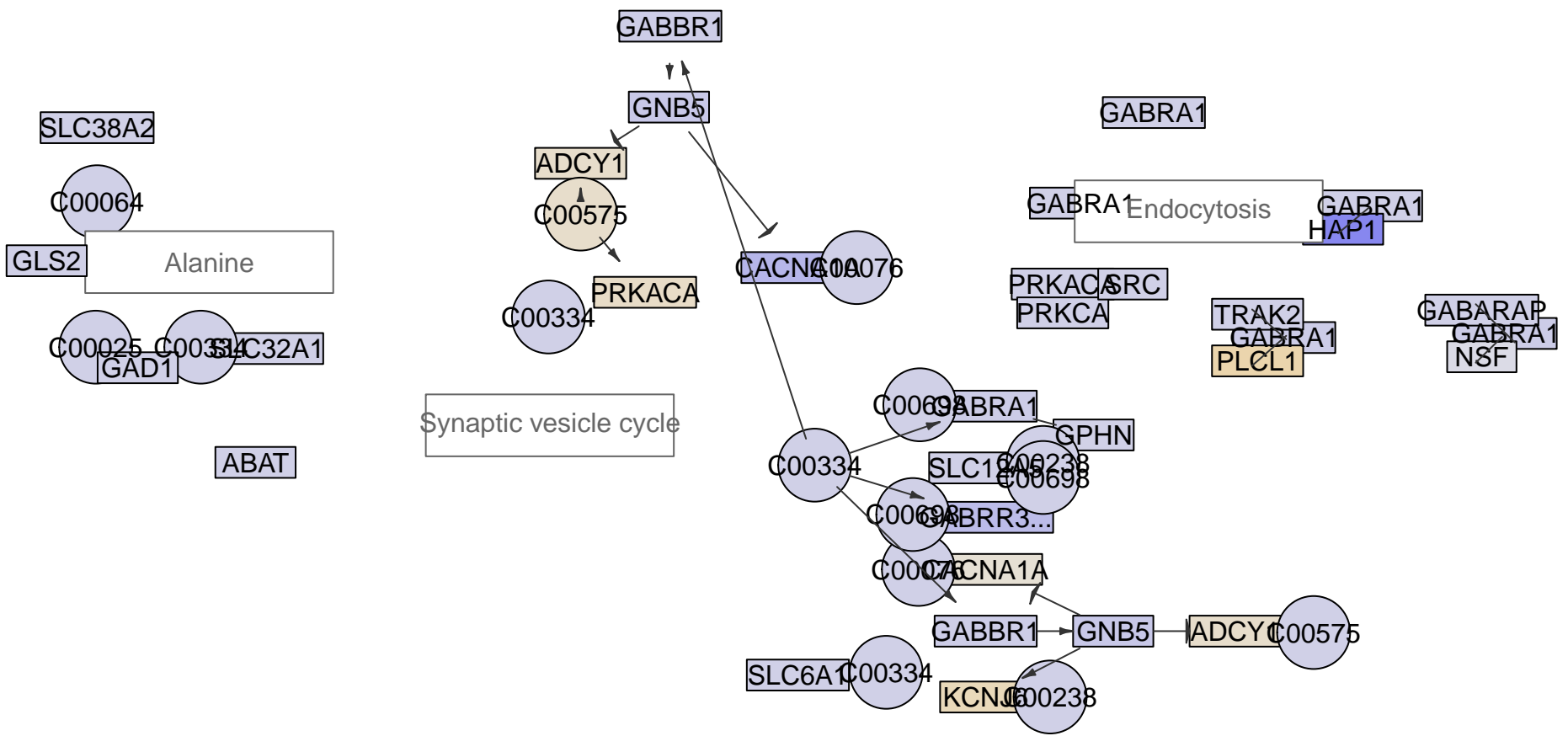

GABAergic synapse
MPI-133

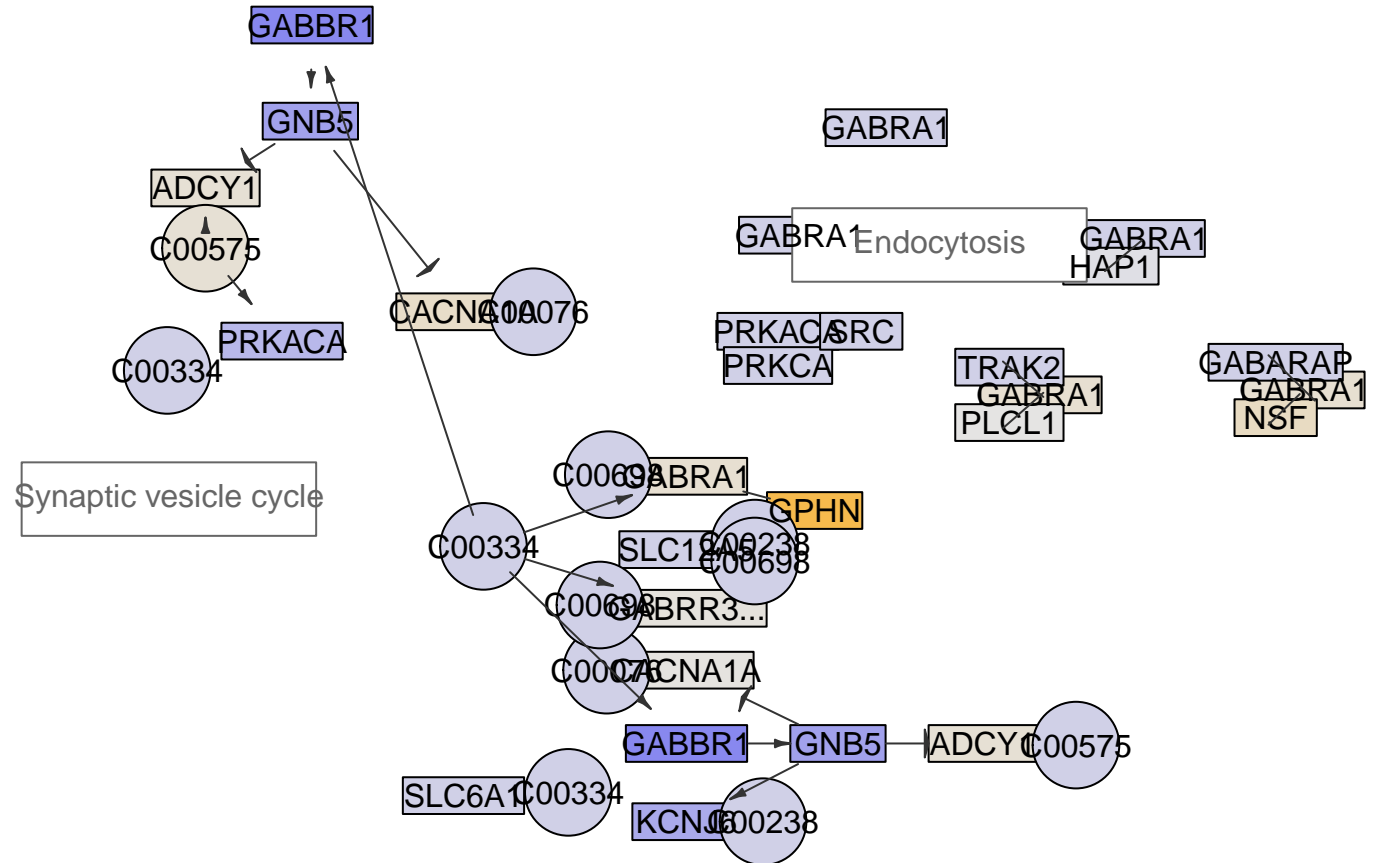
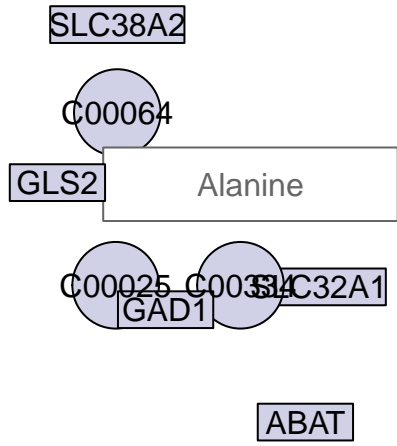
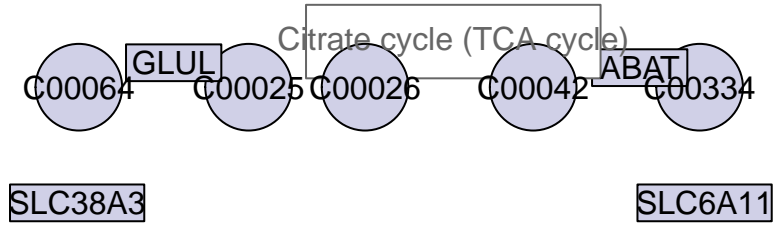

GABAergic synapse
MPI-134

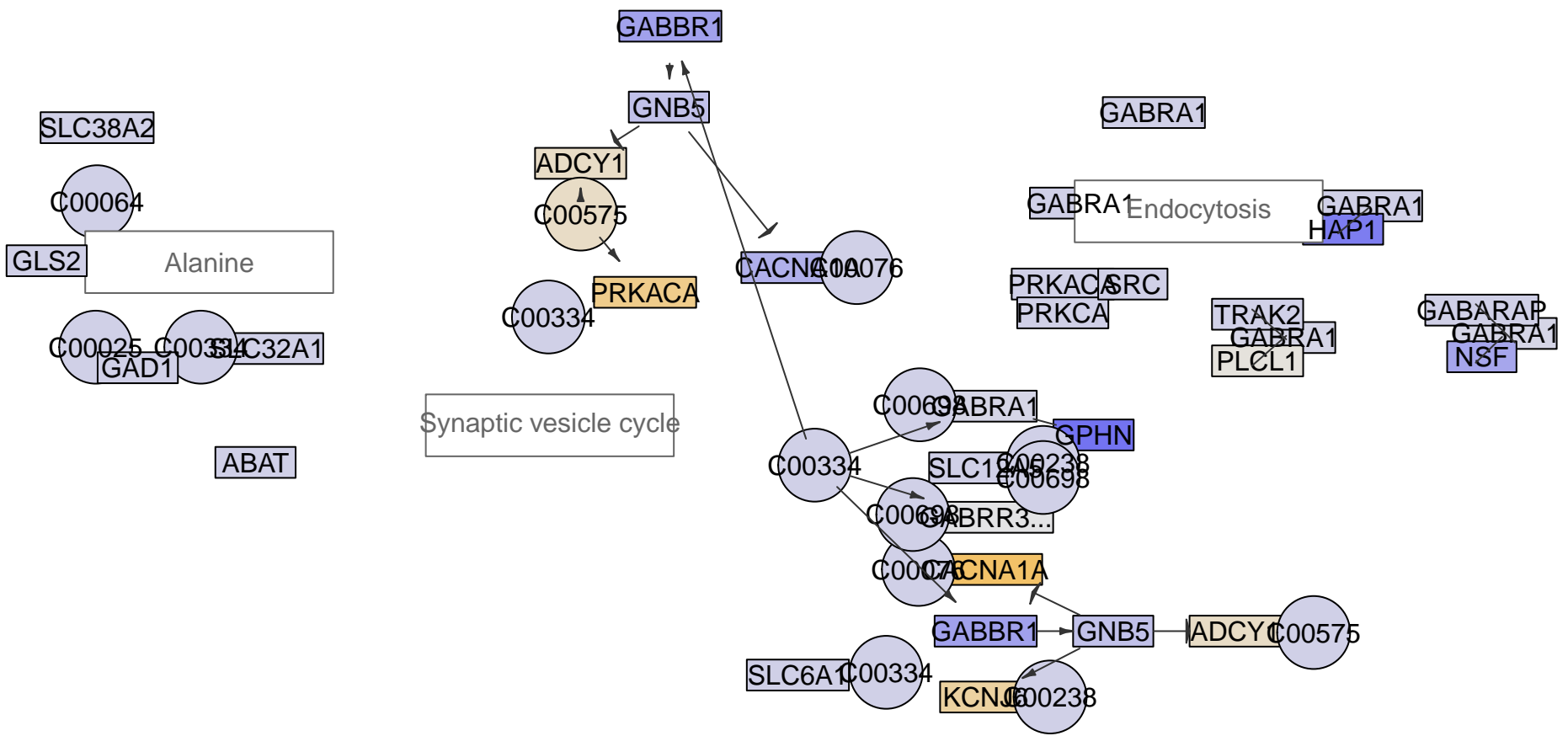

GABAergic synapse
MPI-135

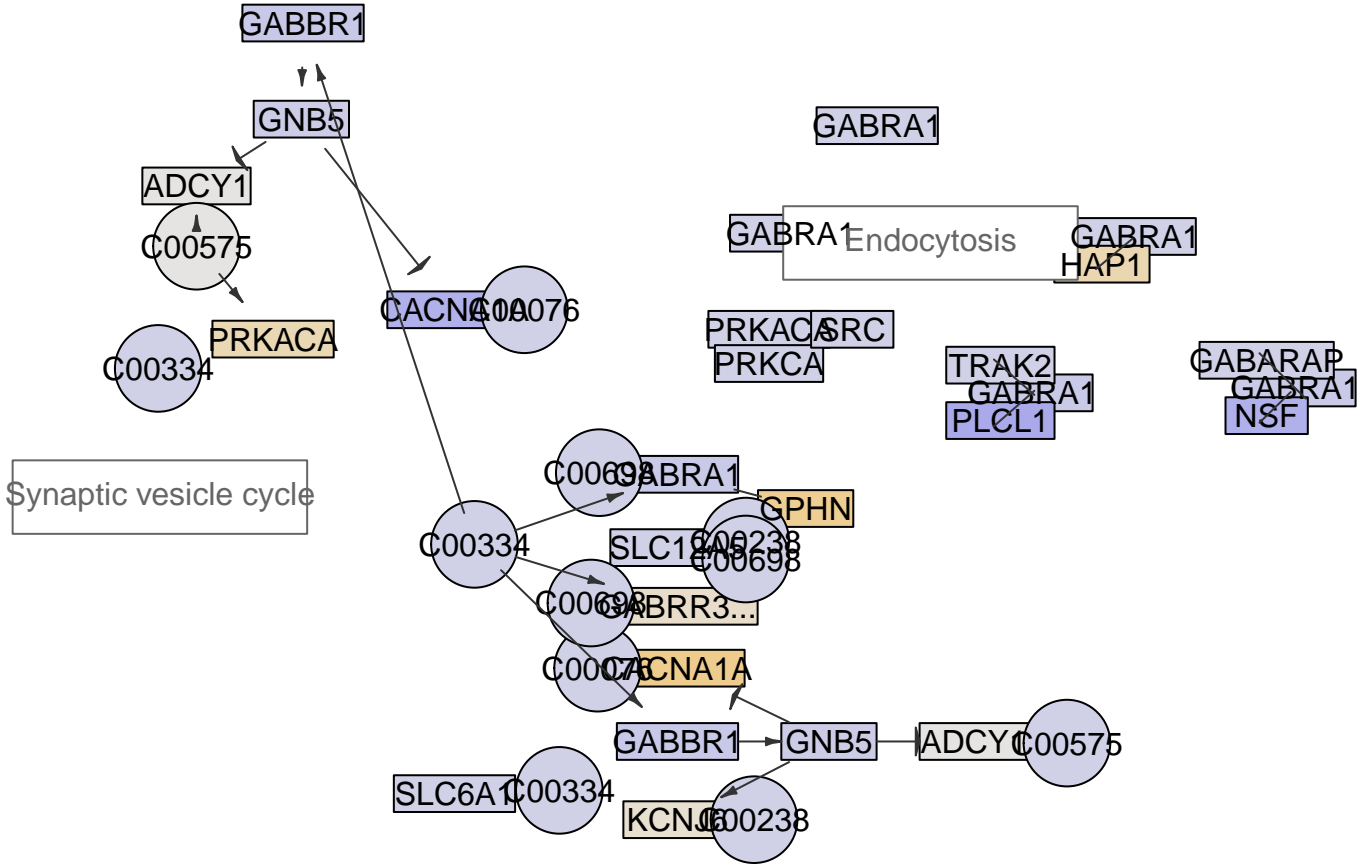
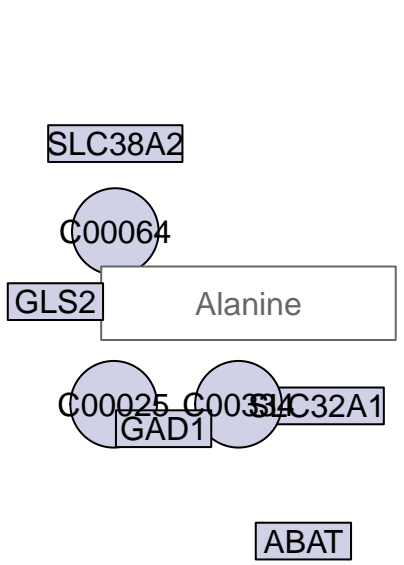

GABAergic synapse
MPI-136

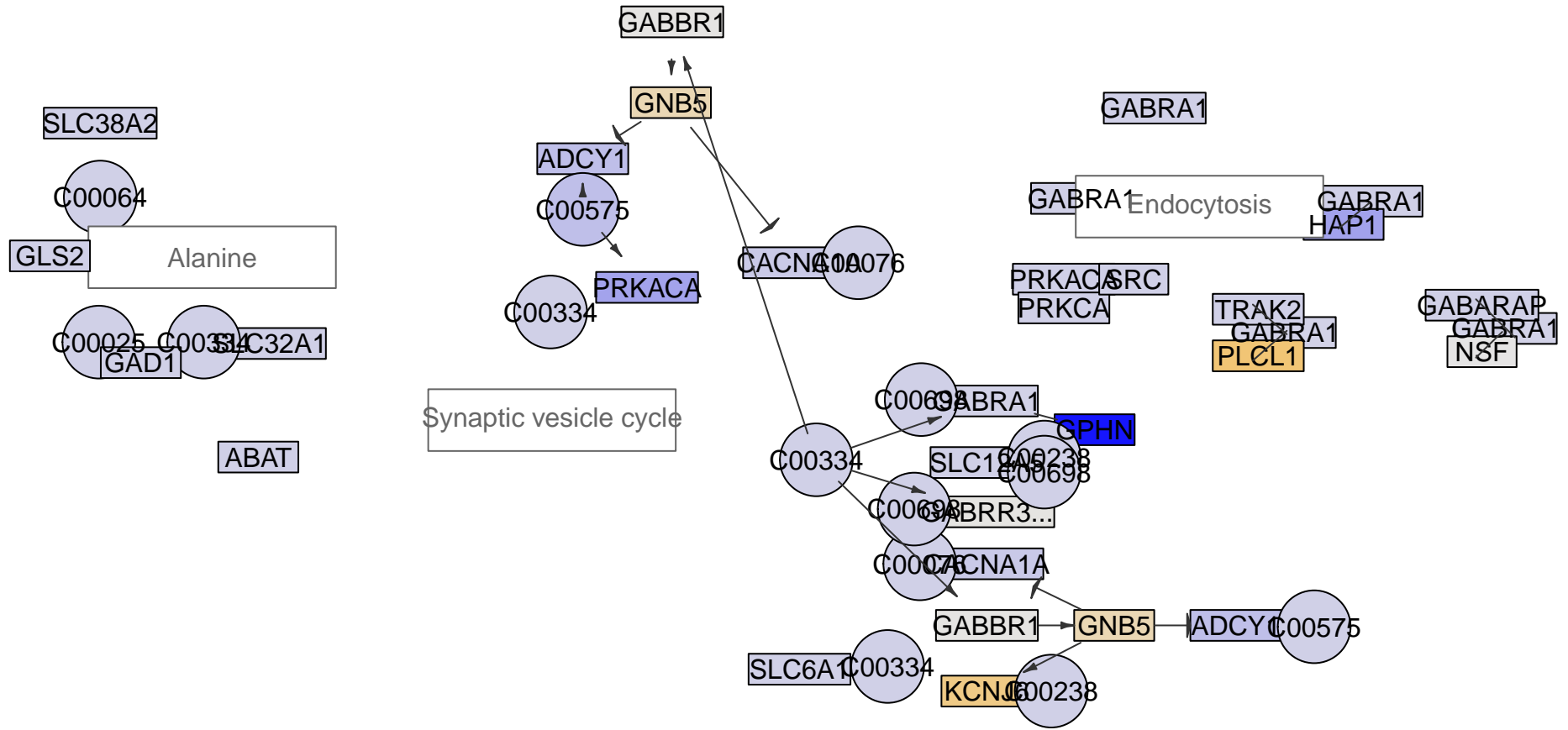

GABAergic synapse
MPI-141

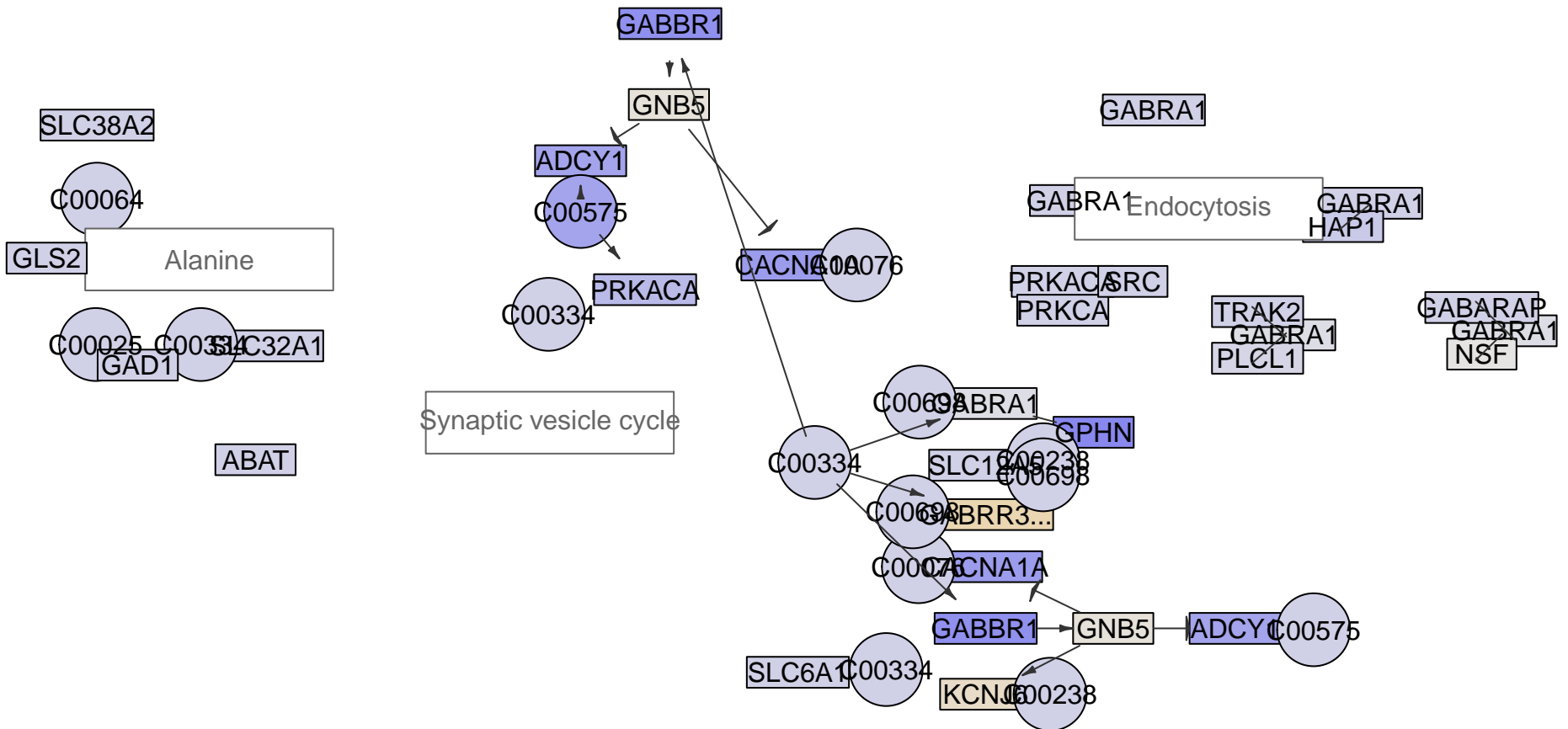
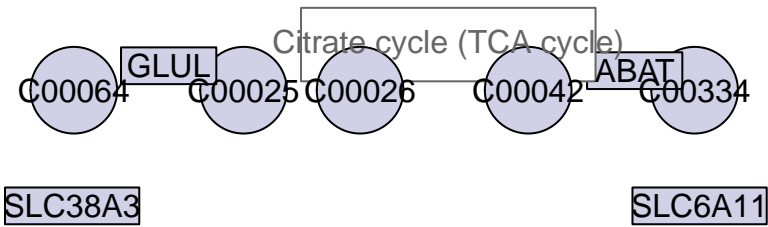

GABAergic synapse
MPI-142

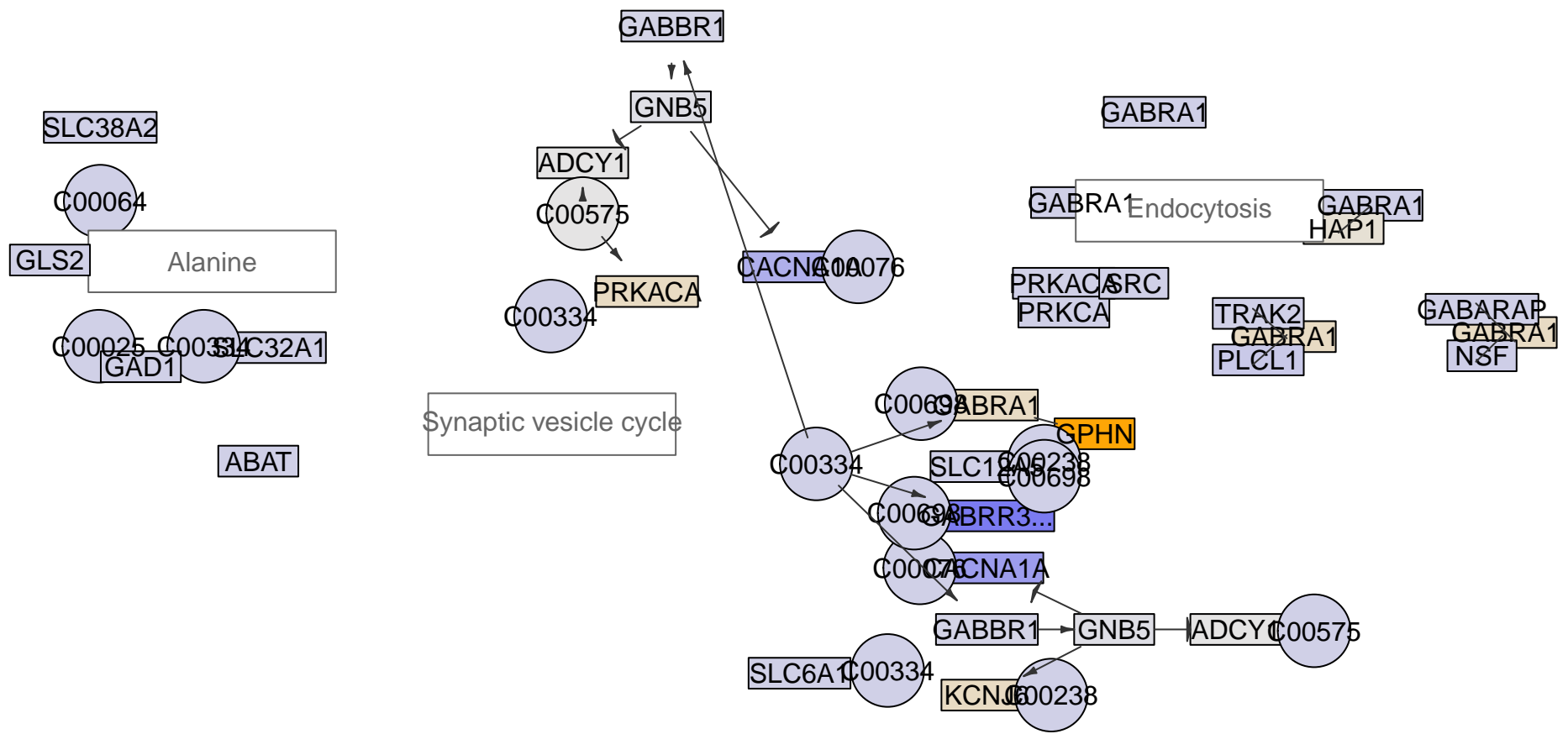

GABAergic synapse
MPI-145

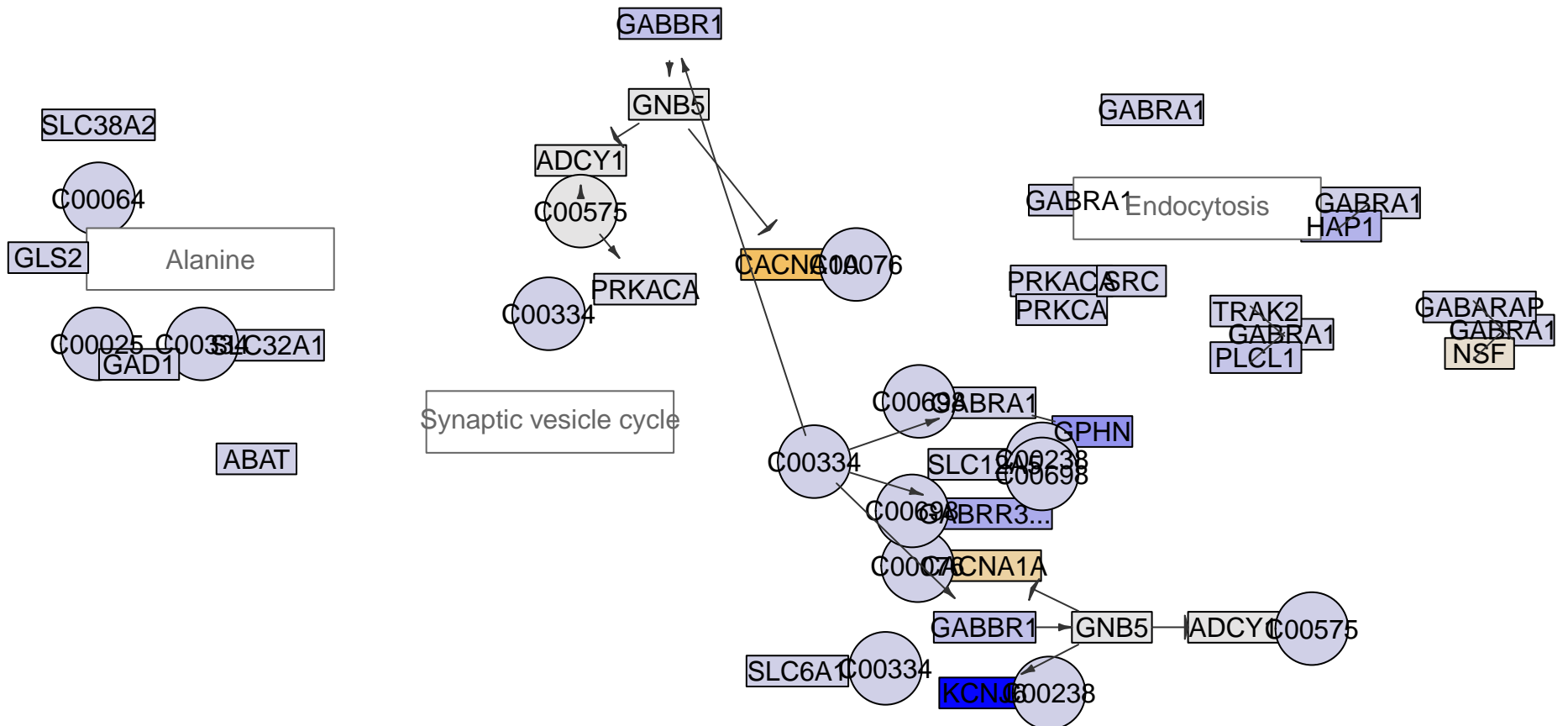

GABAergic synapse
MPI-146

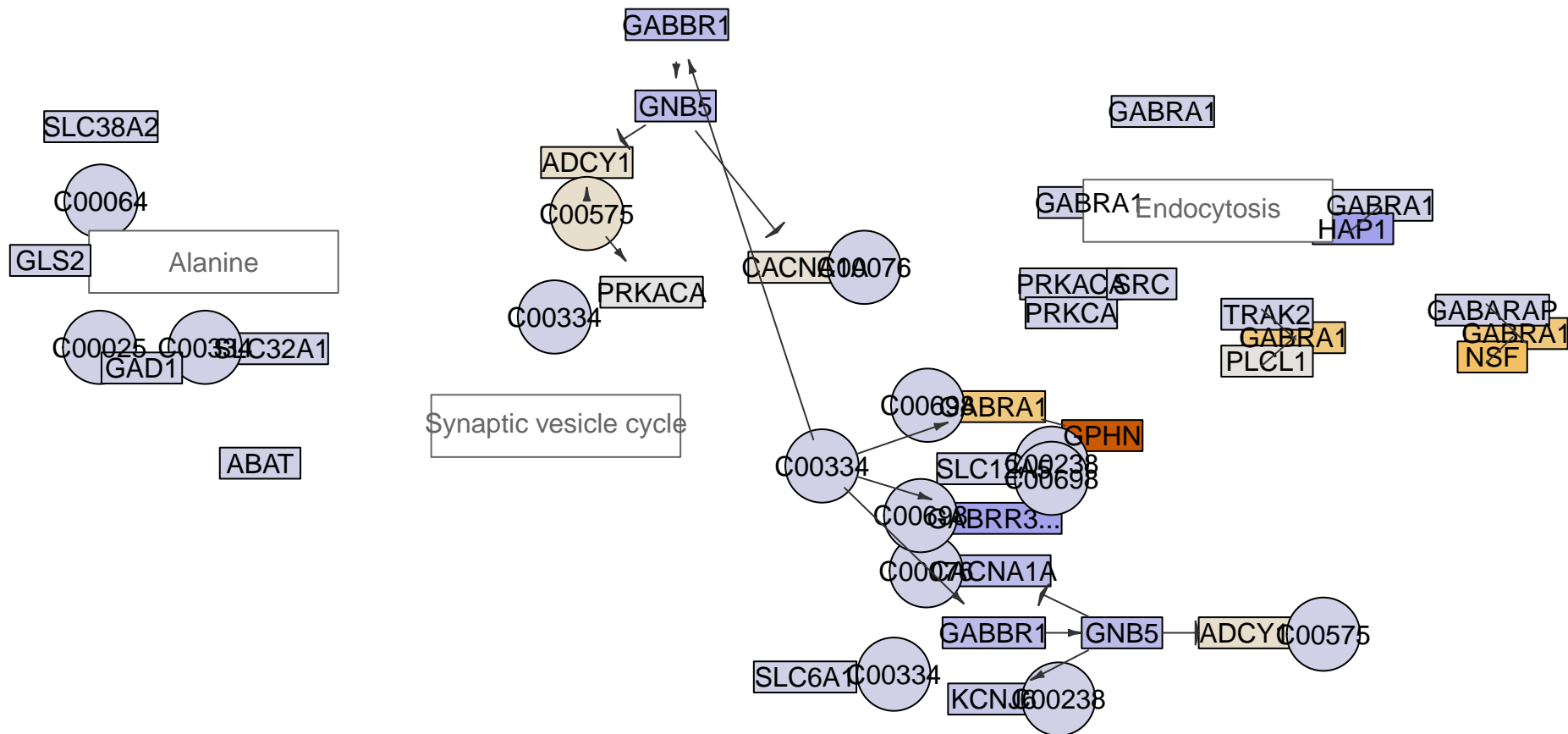
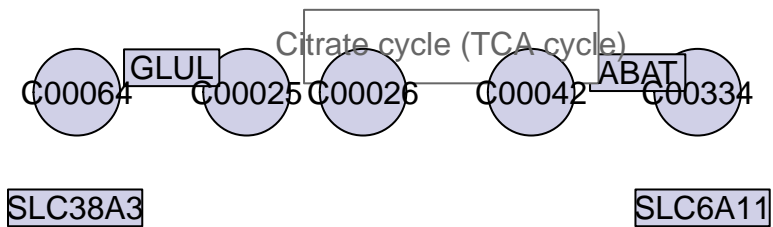

GABAergic synapse
MPI-149

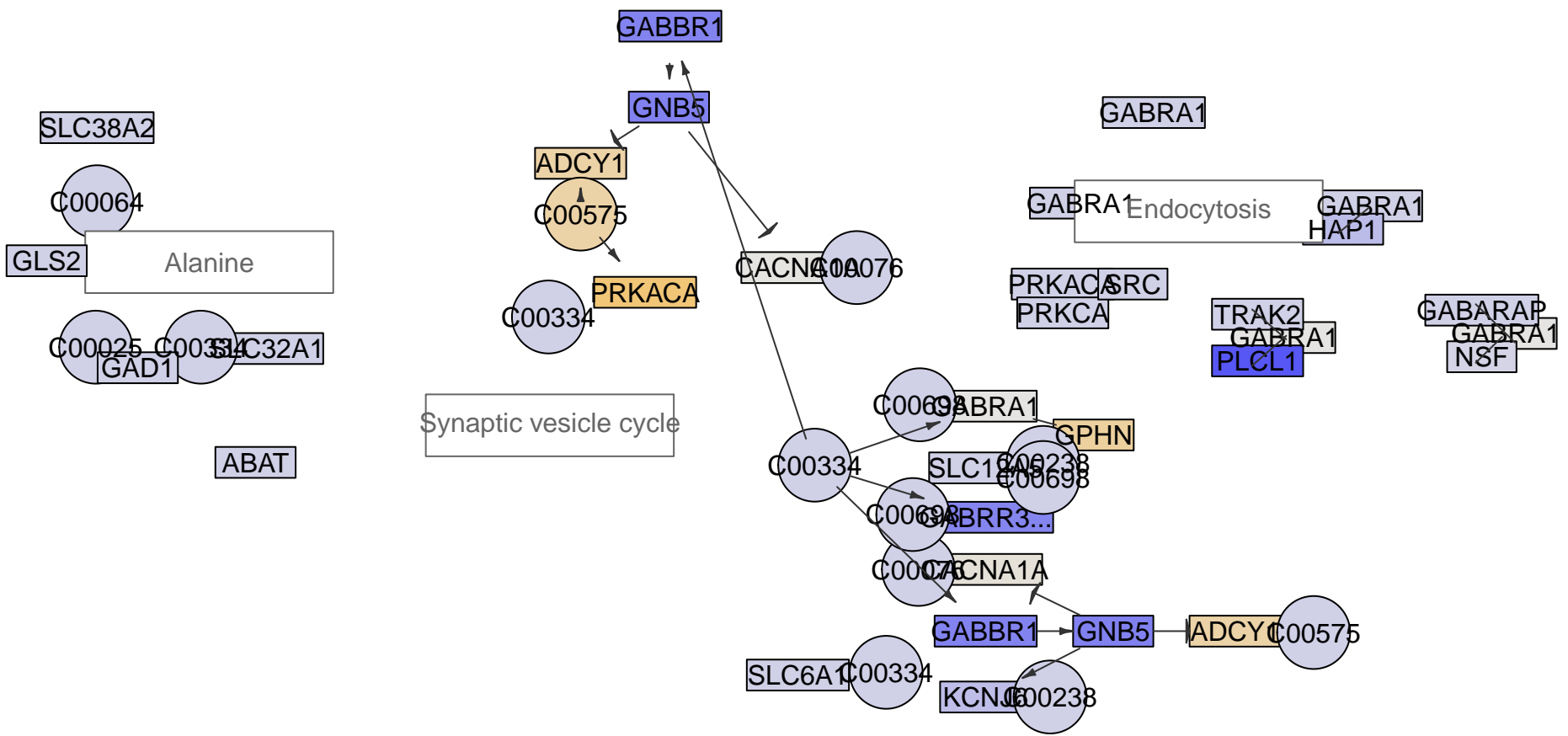

GABAergic synapse
MPI-150

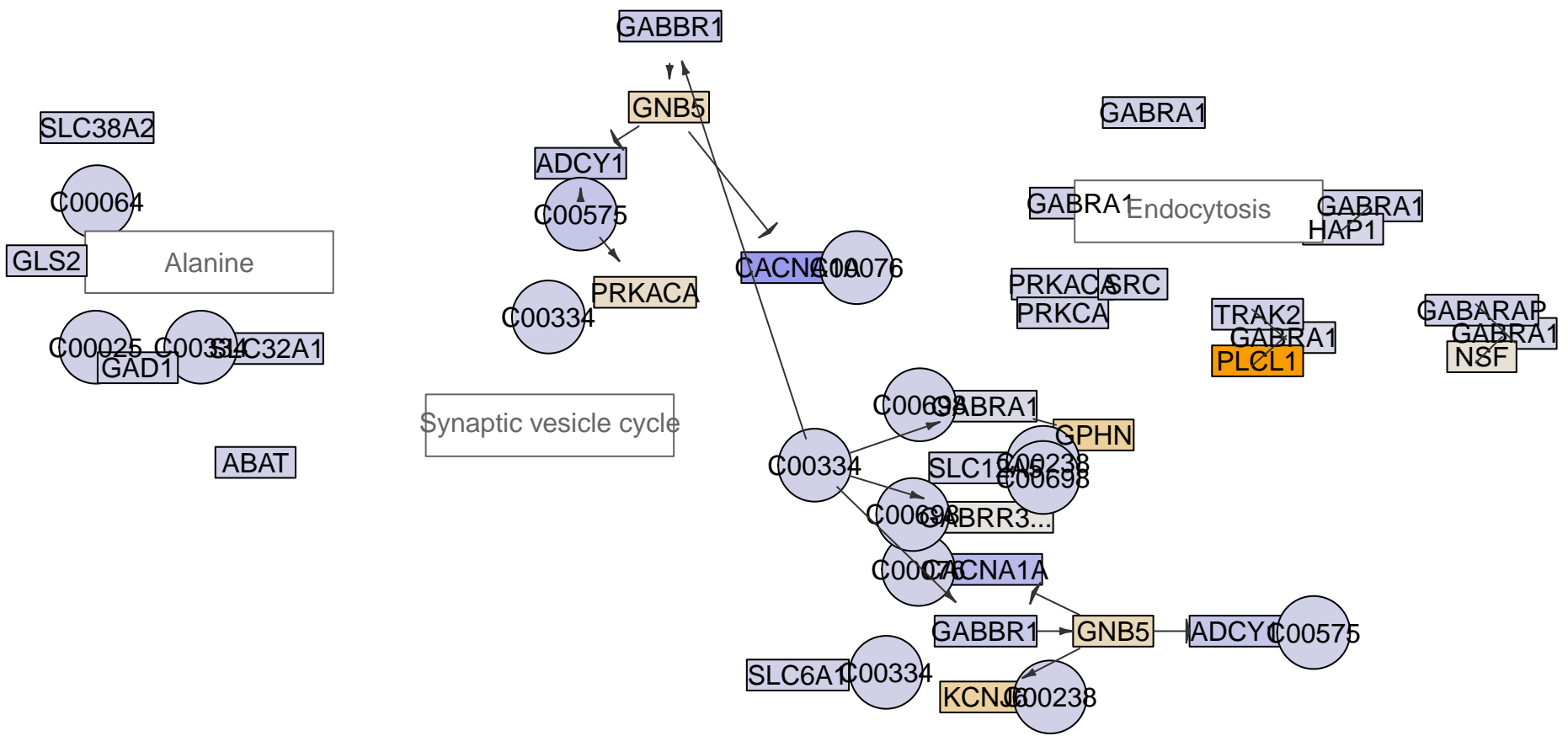

GABAergic synapse
MPI-151

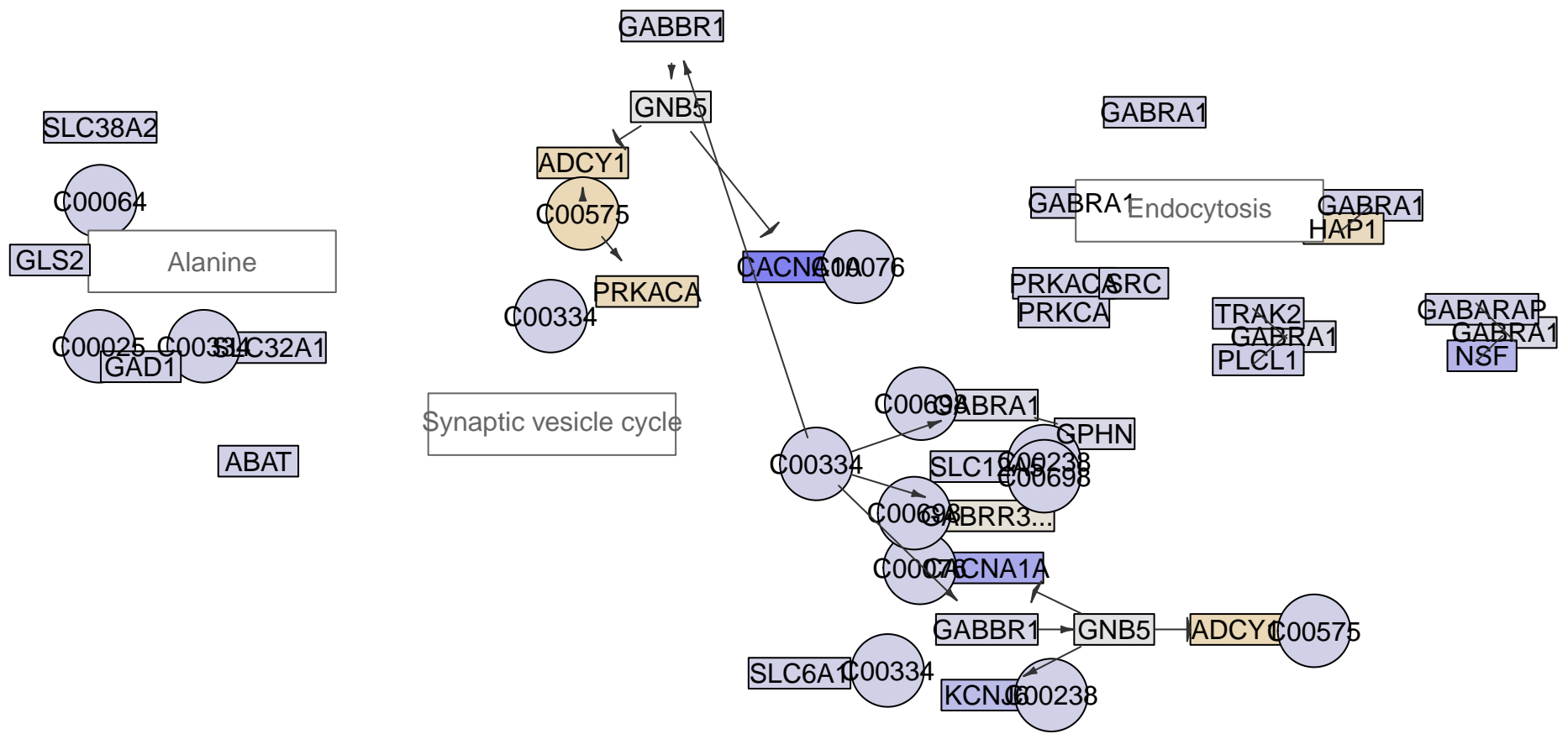

GABAergic synapse
MPI-152

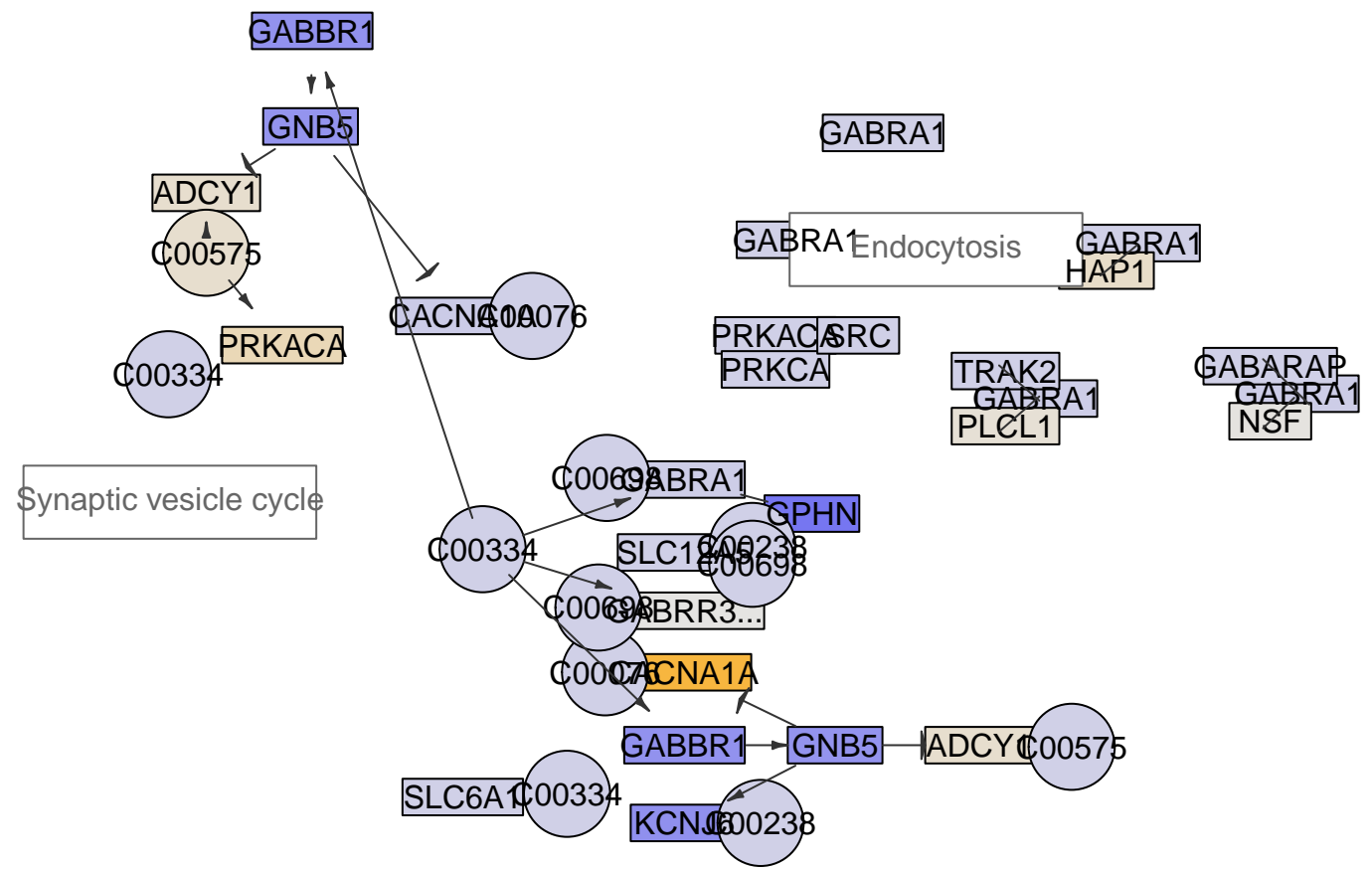
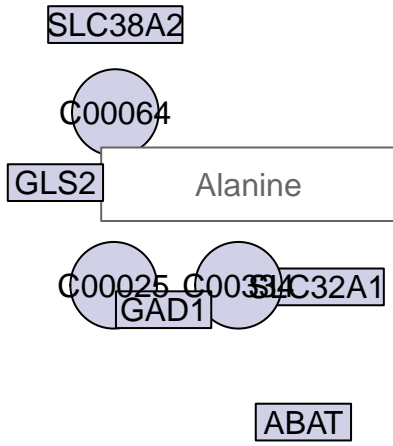

GABAergic synapse
MPI-153

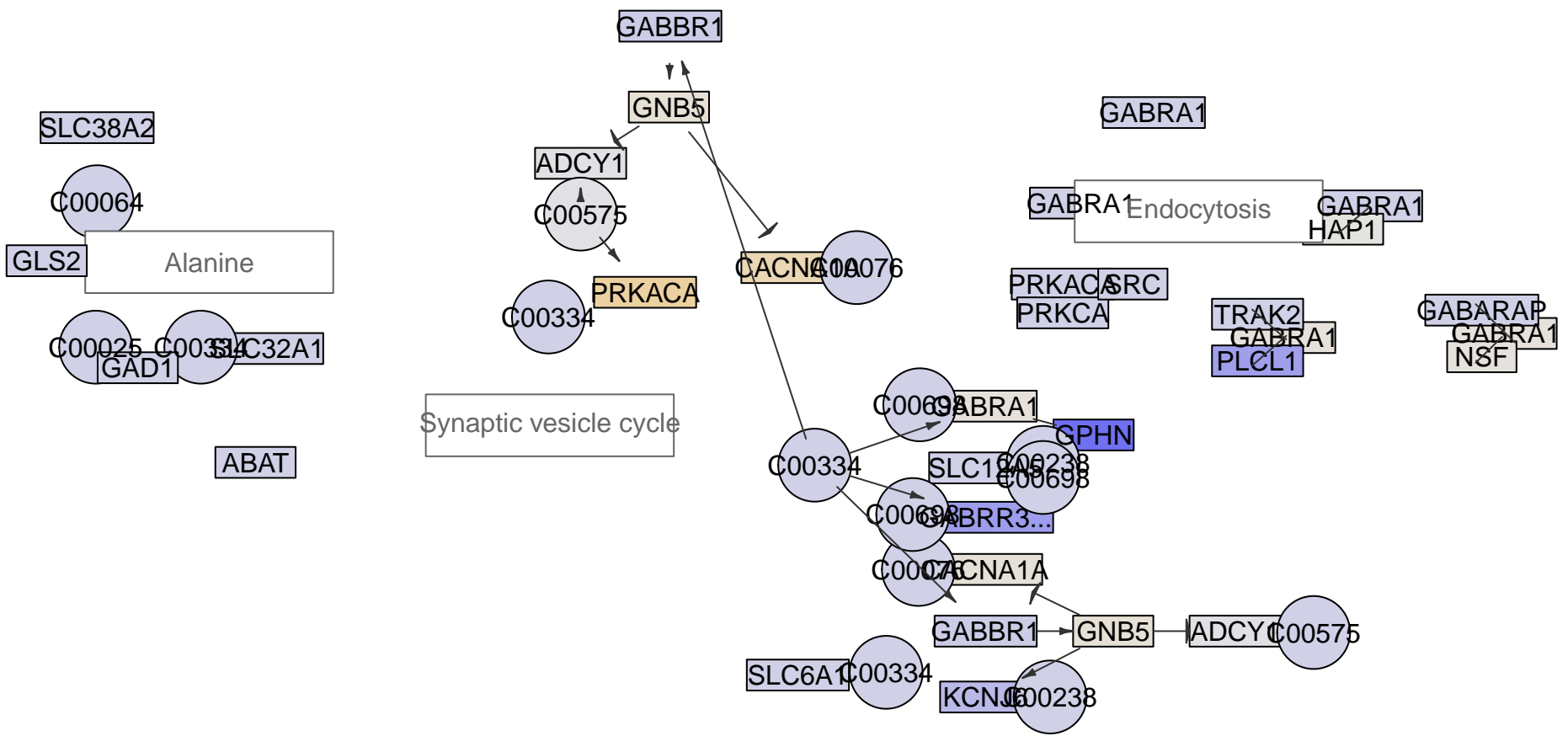

GABAergic synapse
MPI-154

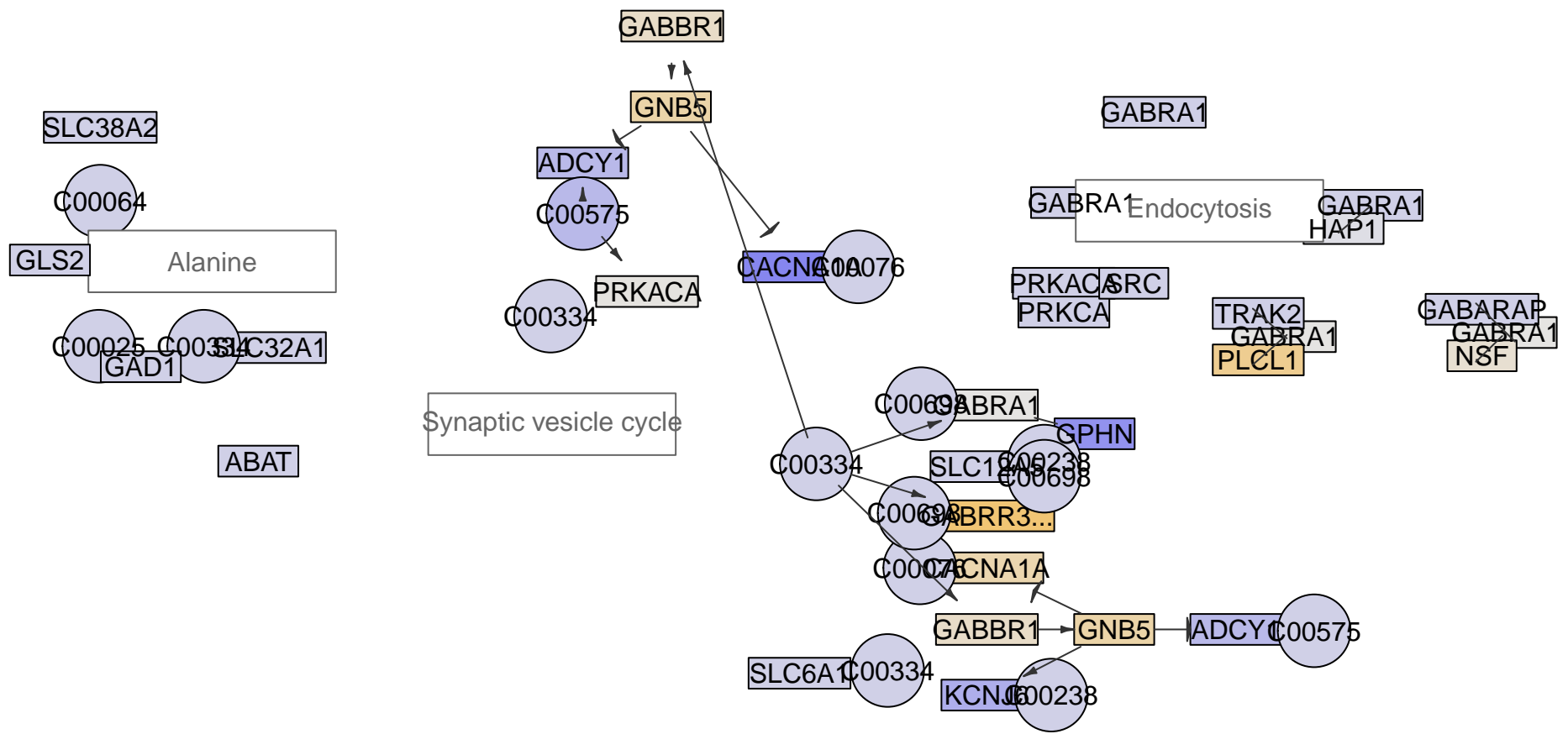

GABAergic synapse
MPI-155

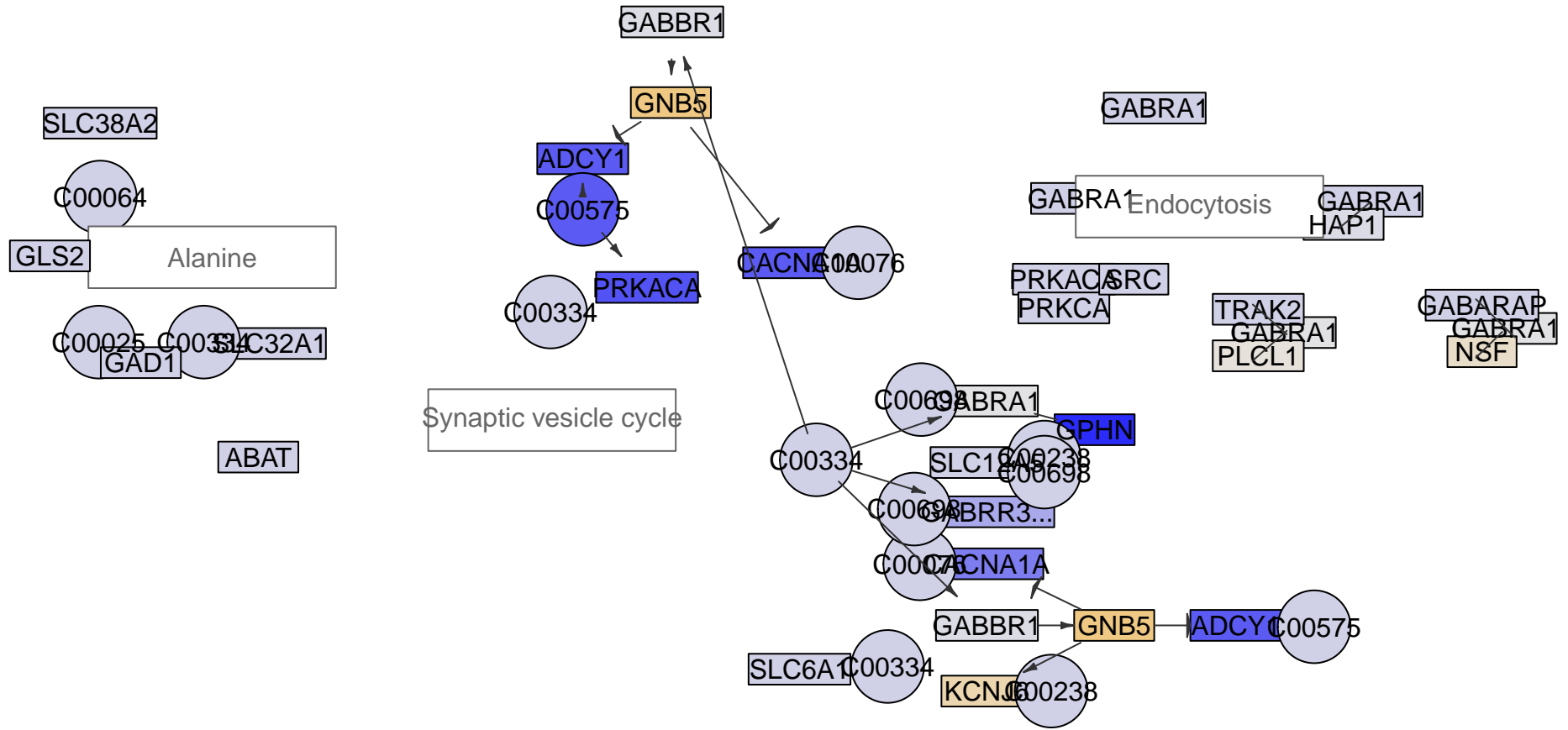

GABAergic synapse
MPI-159

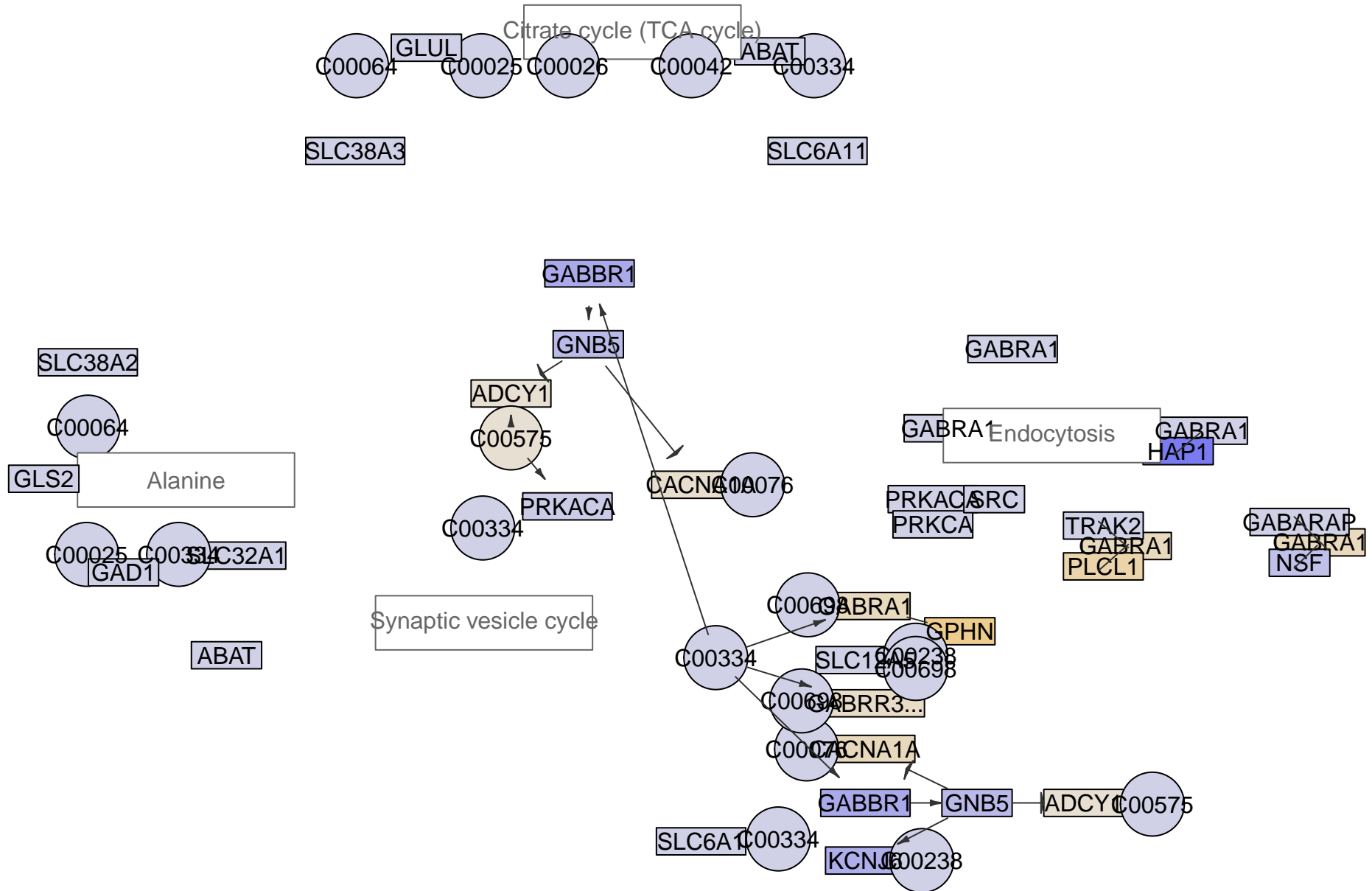

GABAergic synapse
MPI-163

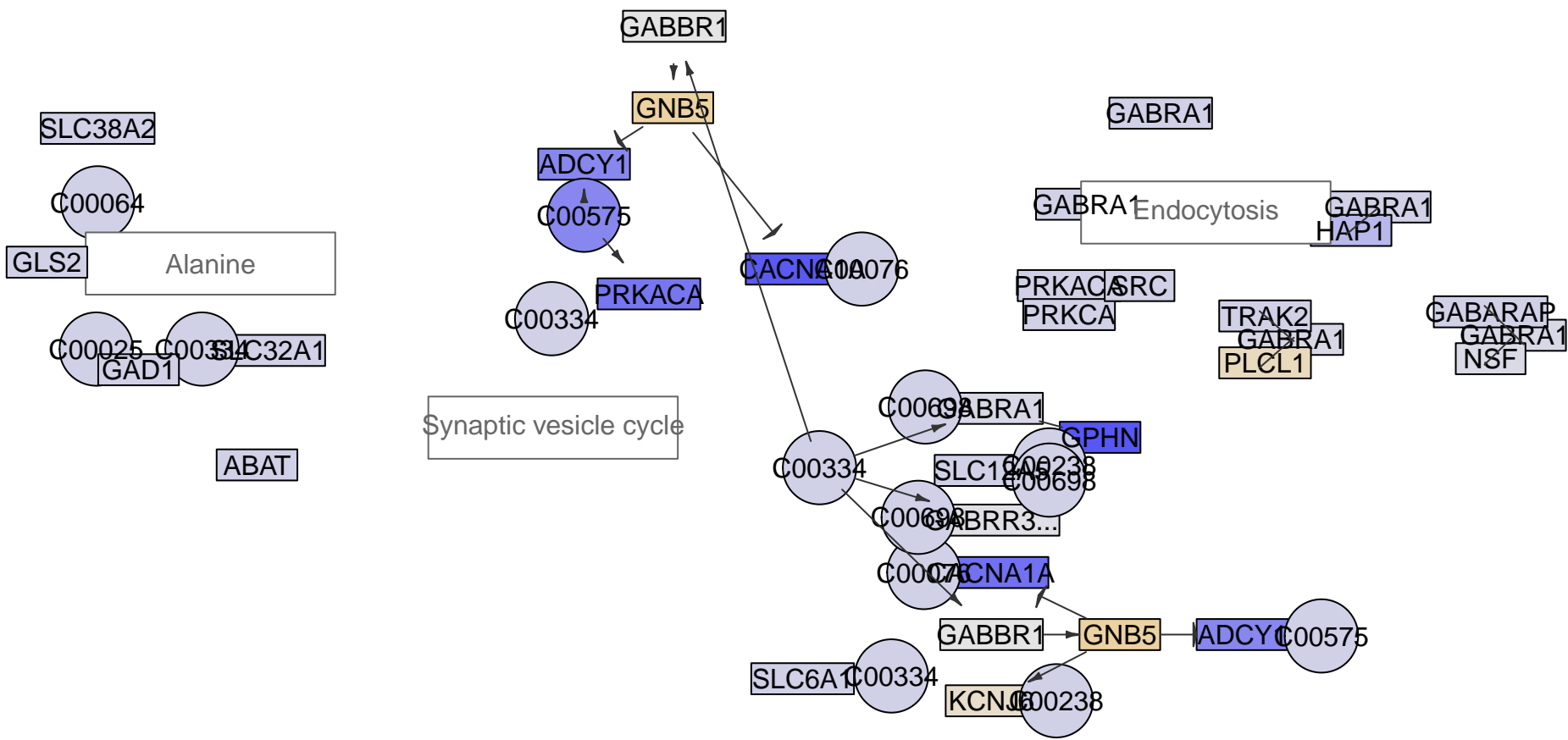

GABAergic synapse
MPI-164

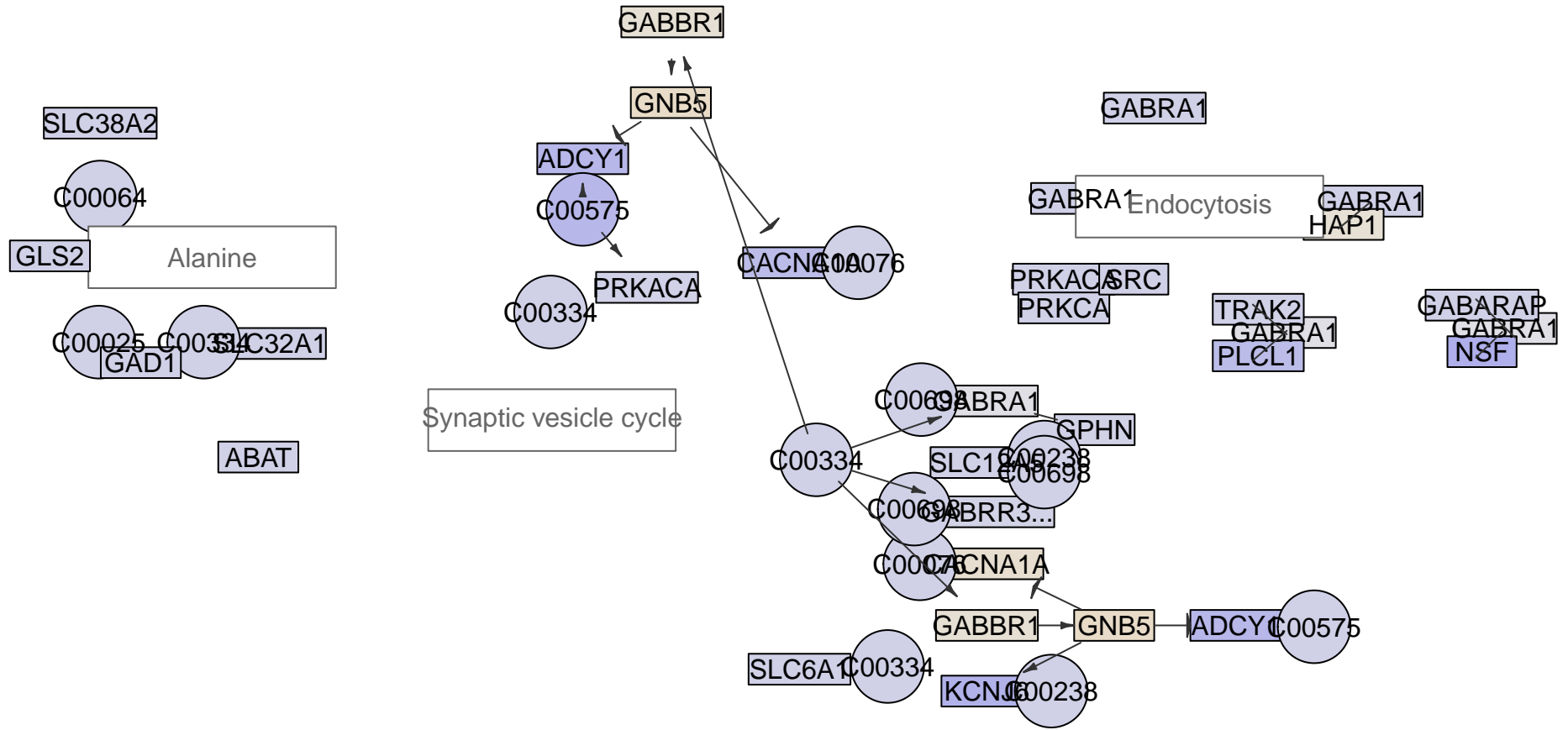
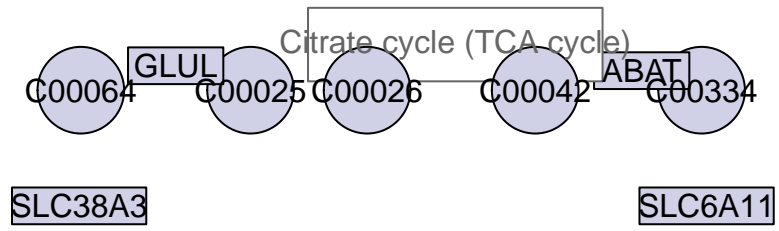

GABAergic synapse
MPI-166

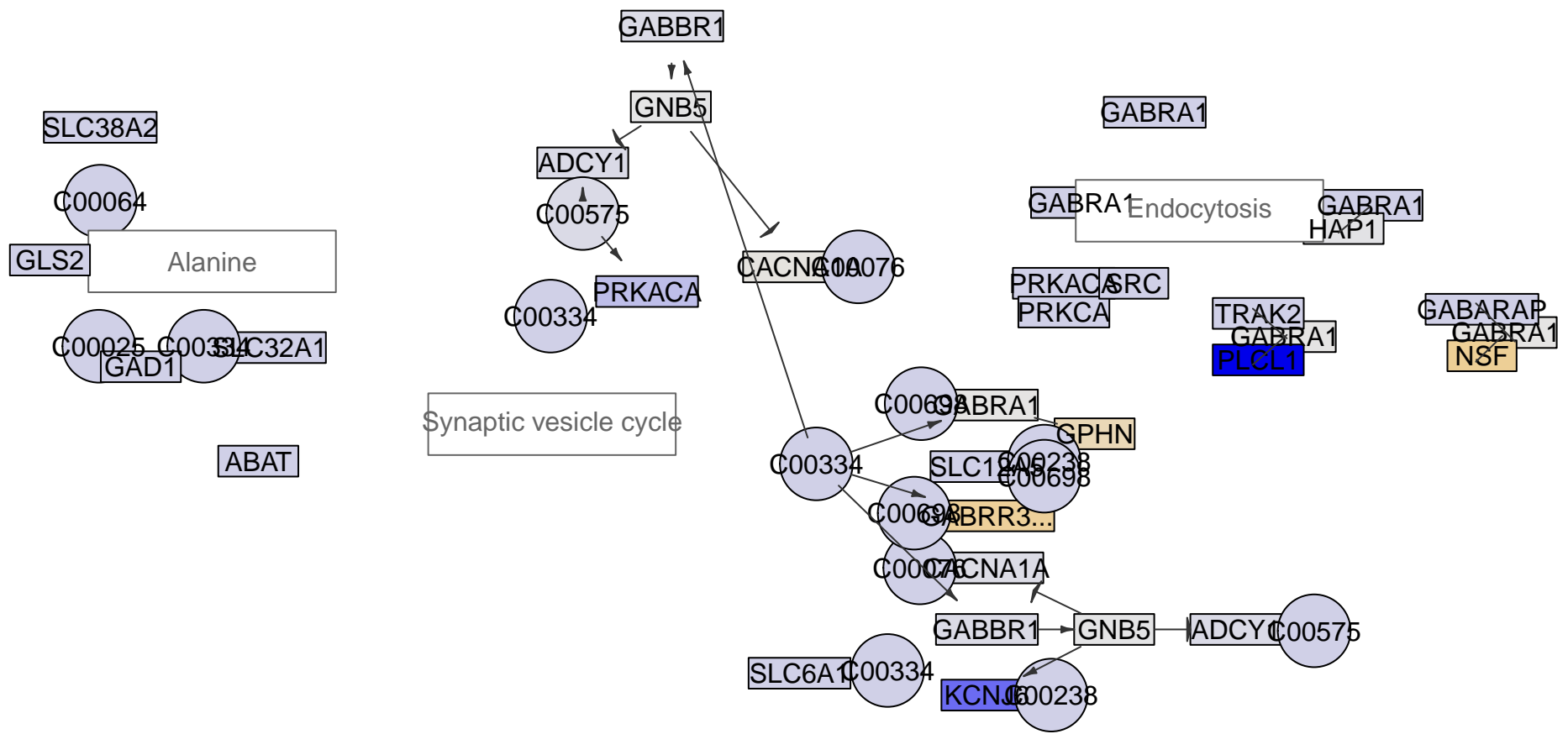

GABAergic synapse
MPI-167

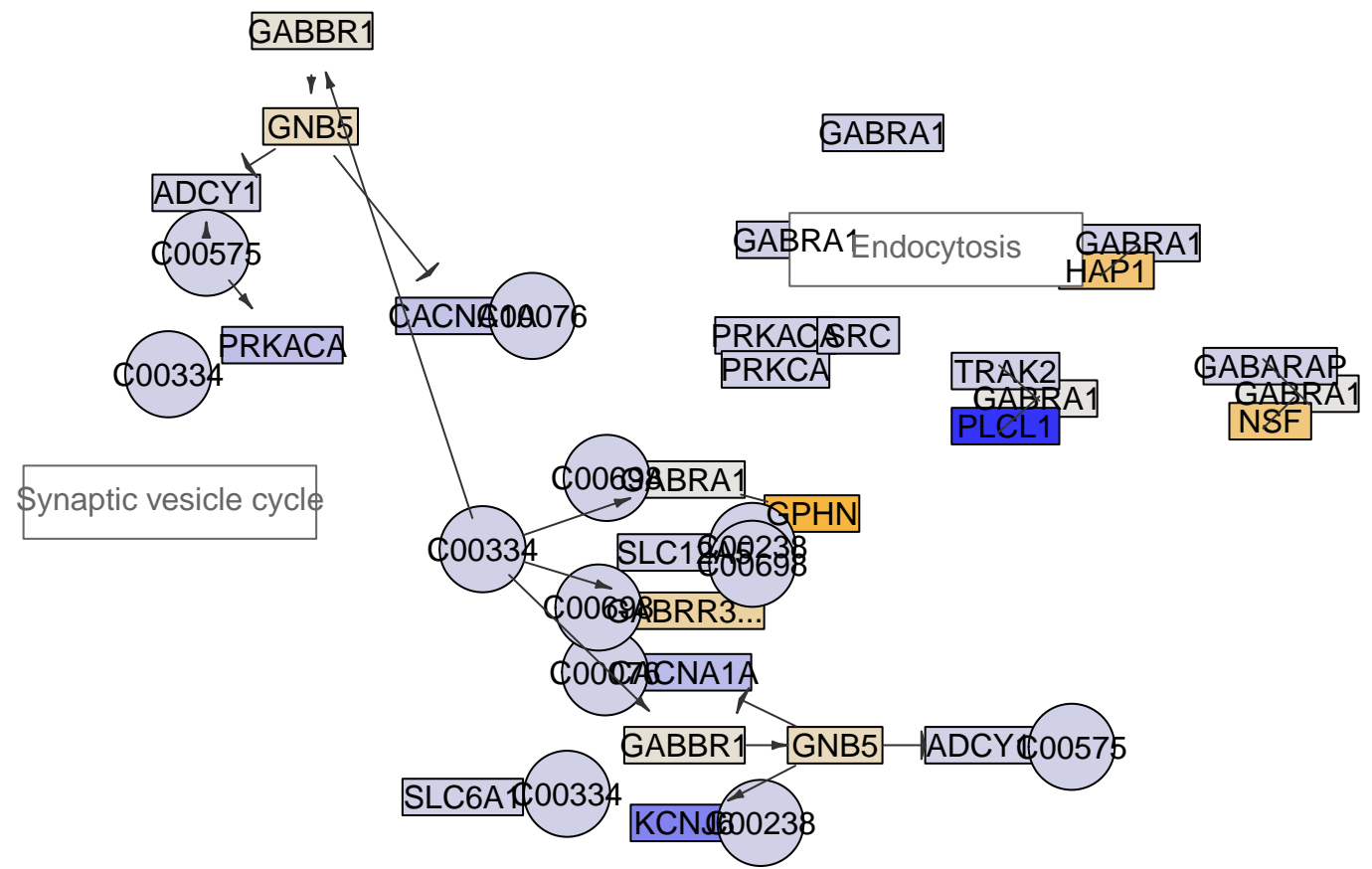
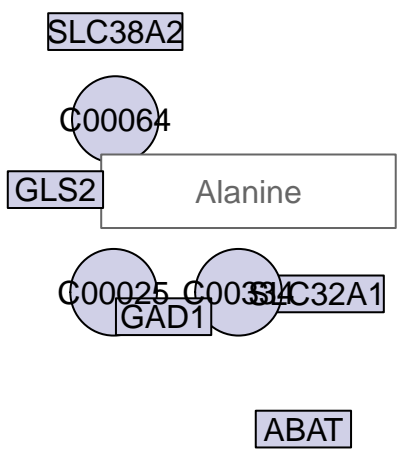

GABAergic synapse
MPI-168

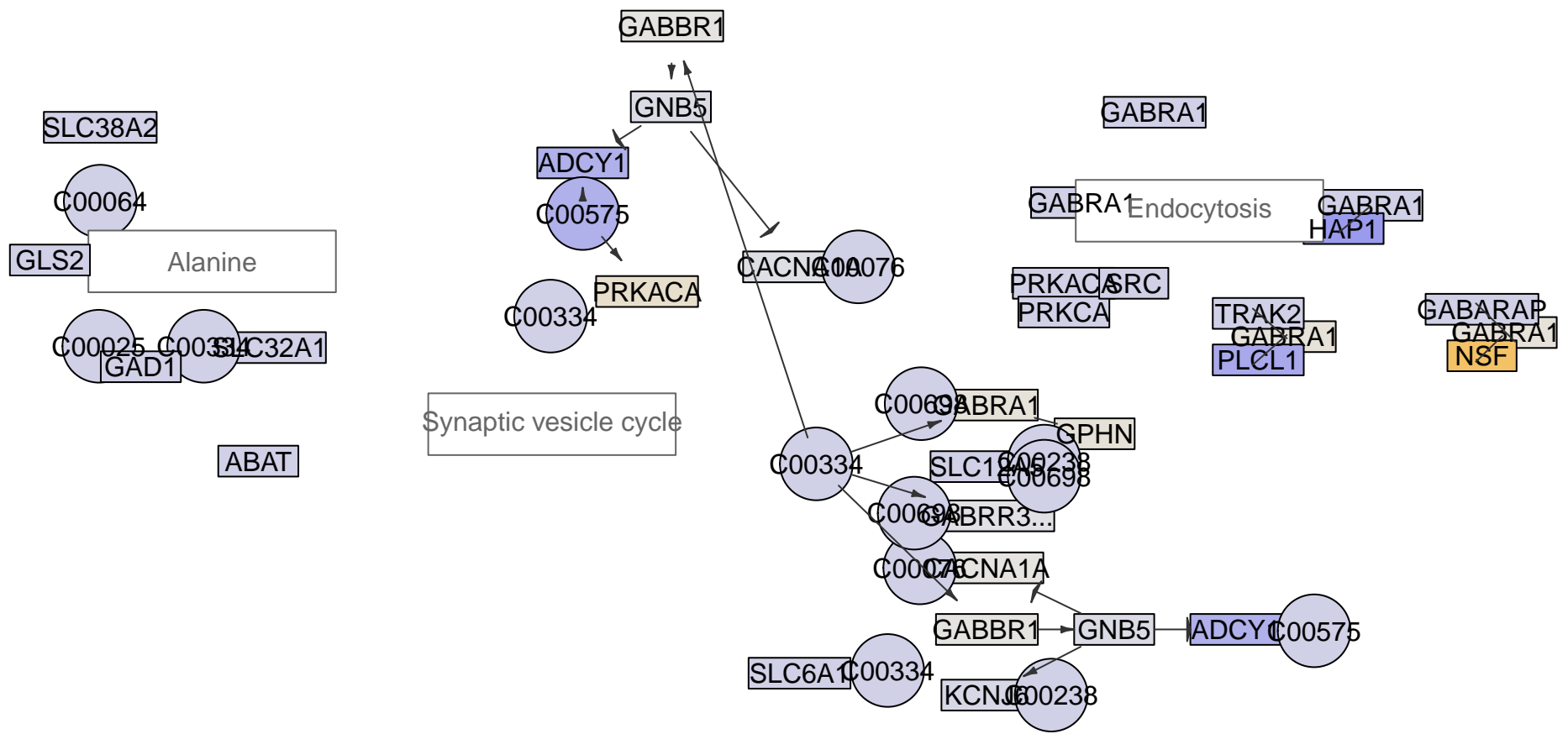

GABAergic synapse
MPI-170

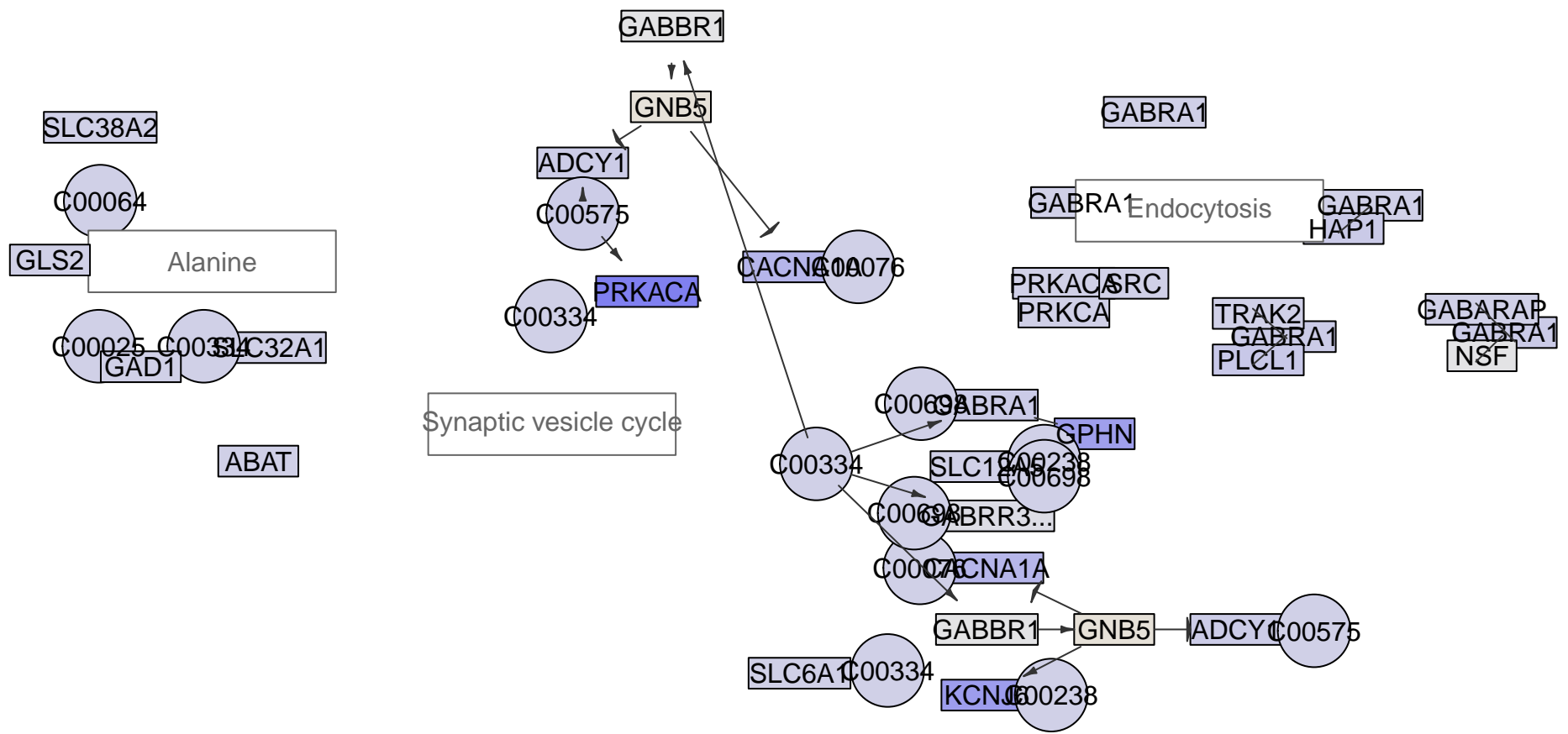

GABAergic synapse
MPI-173

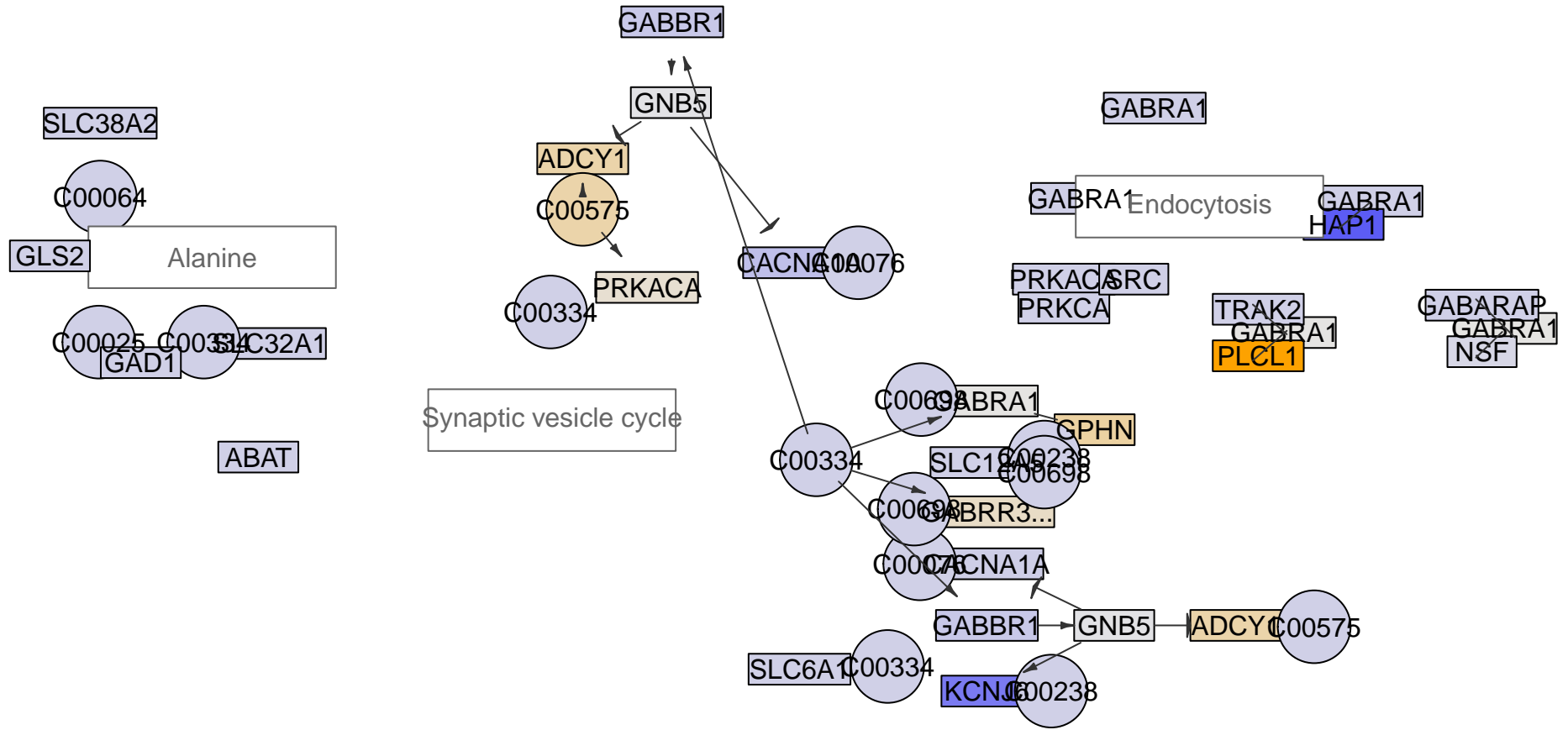

GABAergic synapse
MPI-174

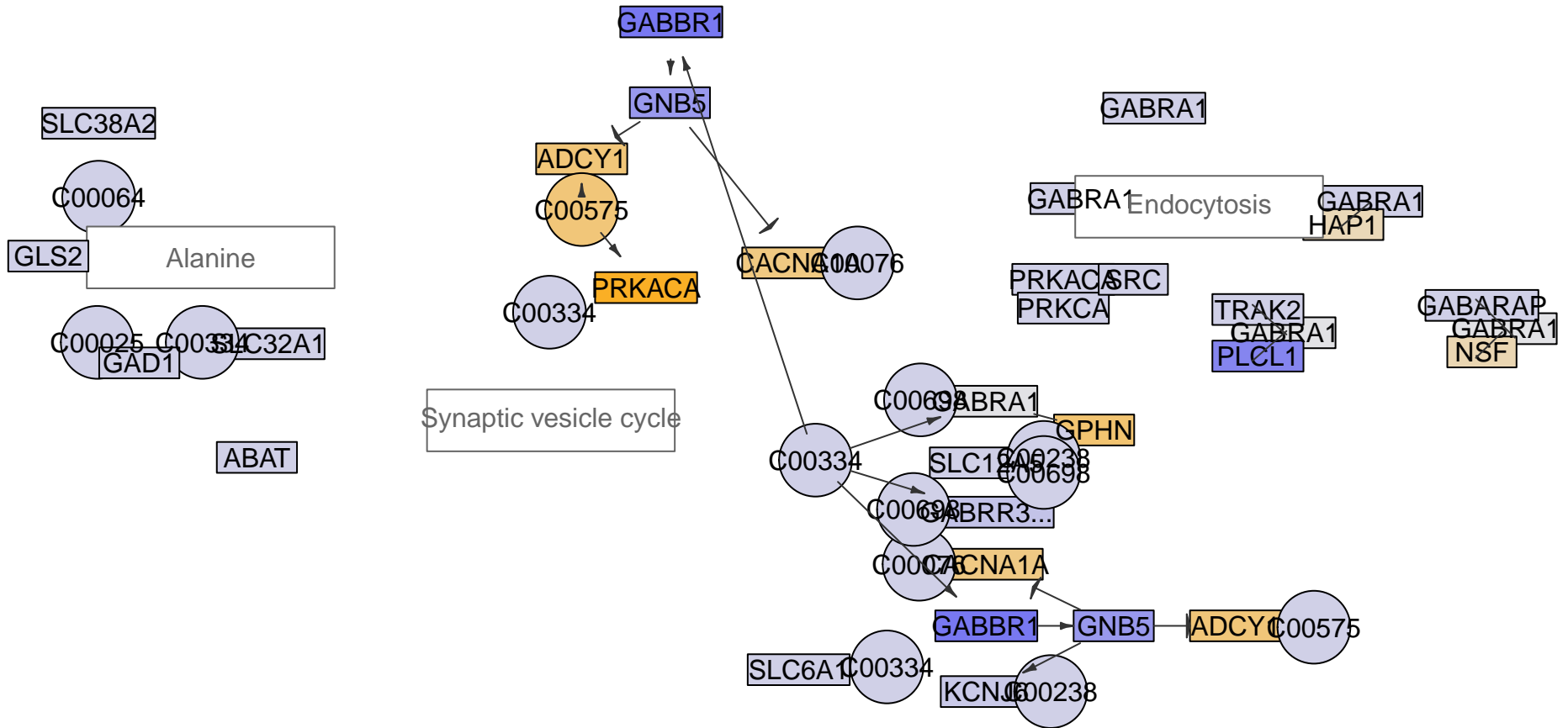
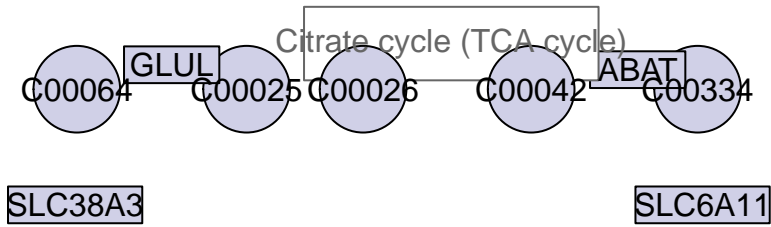

GABAergic synapse
MPI-176

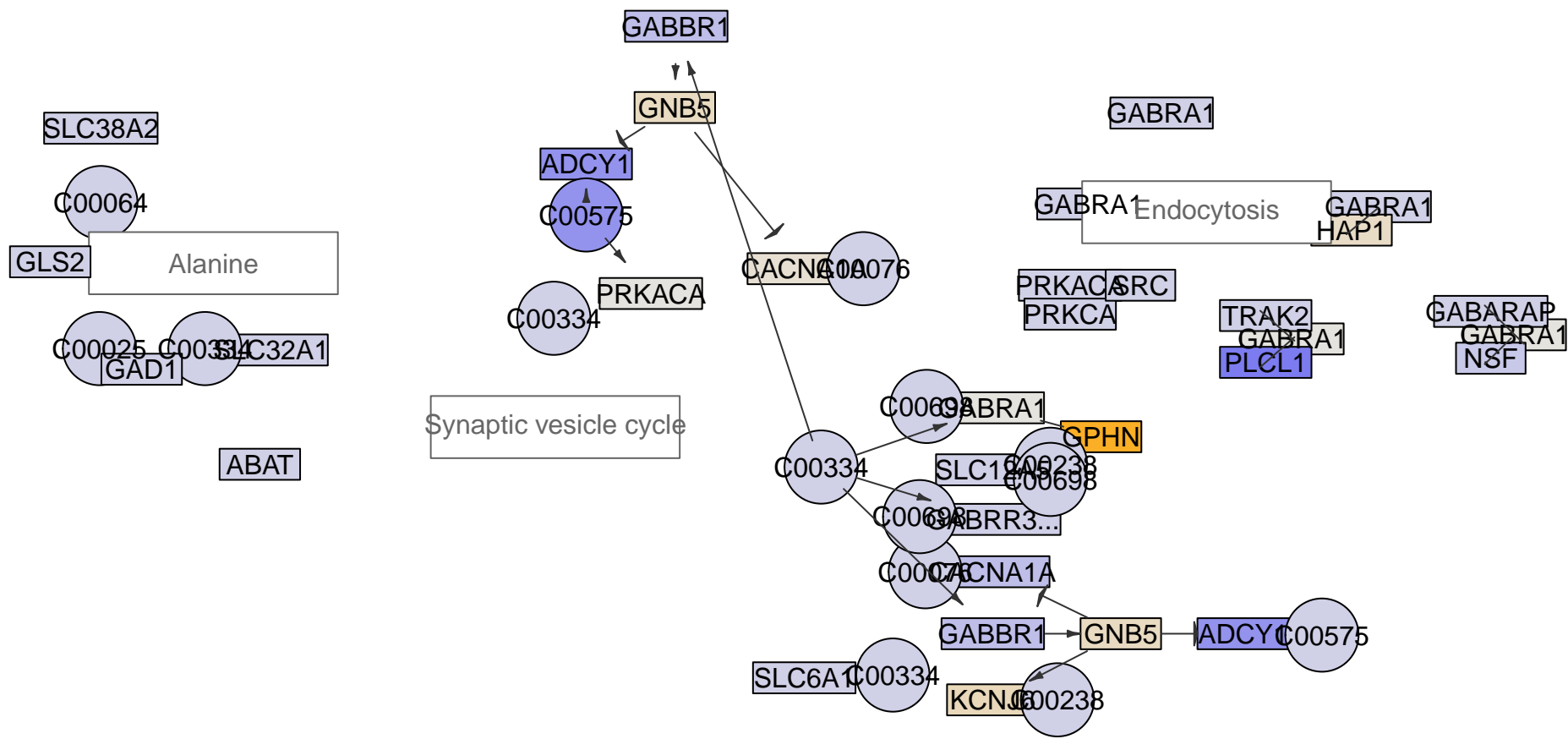

GABAergic synapse
MPI-177

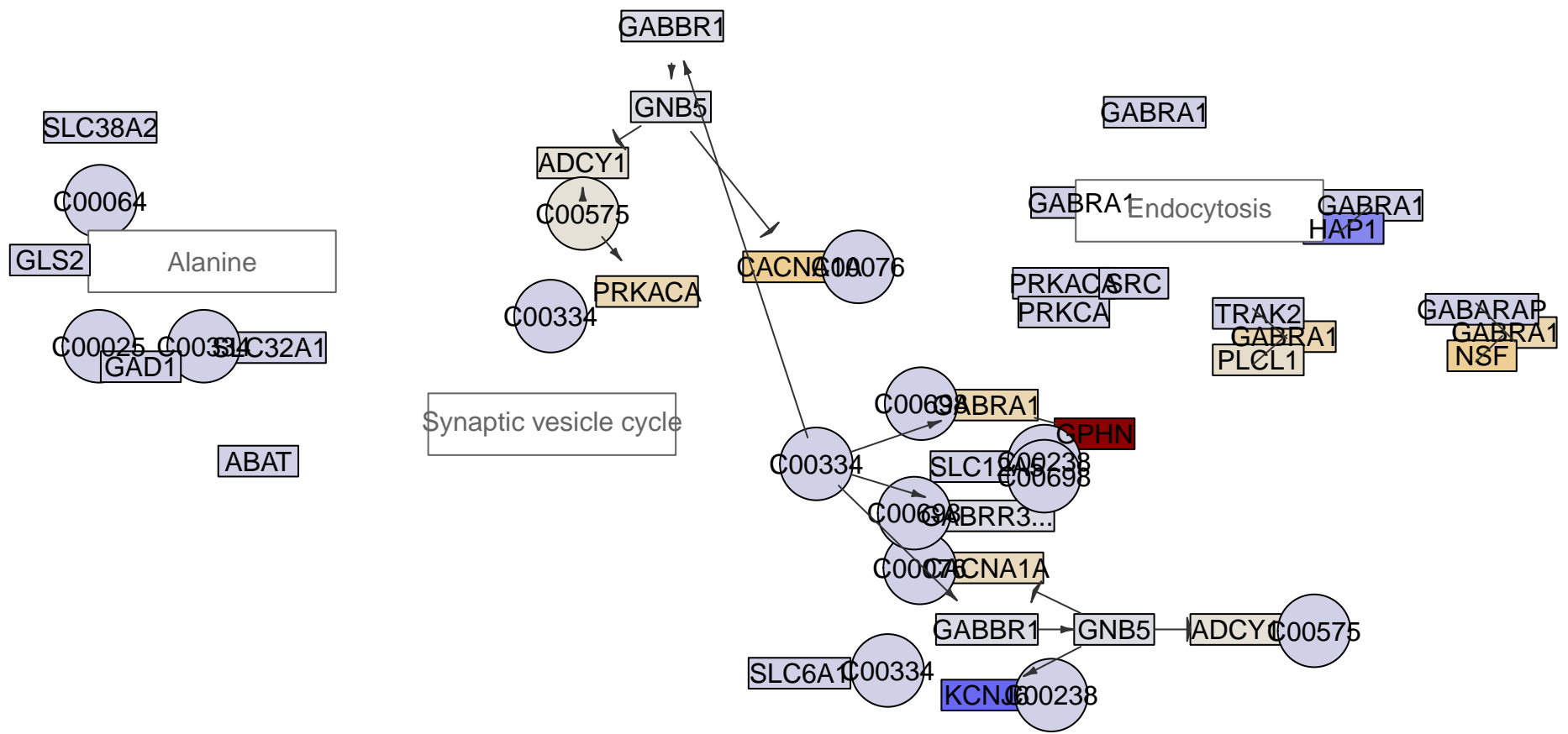

GABAergic synapse
MPI-178

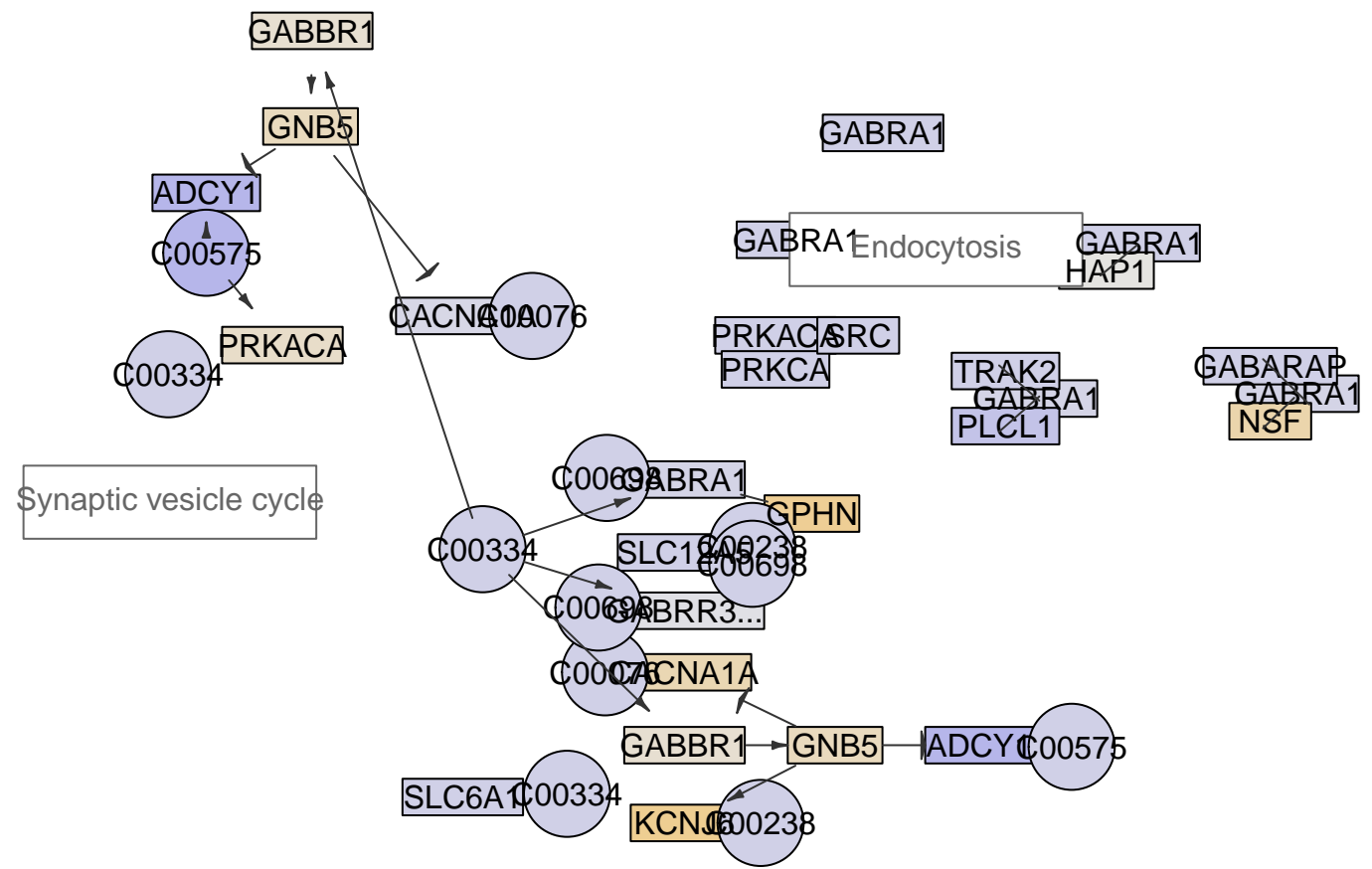
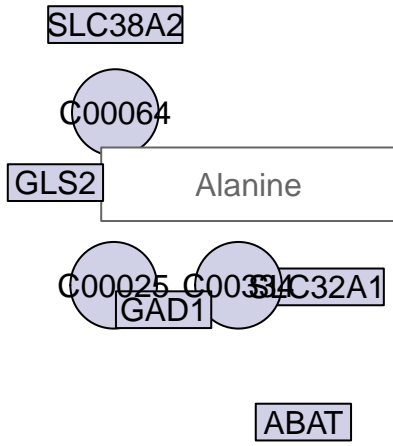

GABAergic synapse
MPI-179

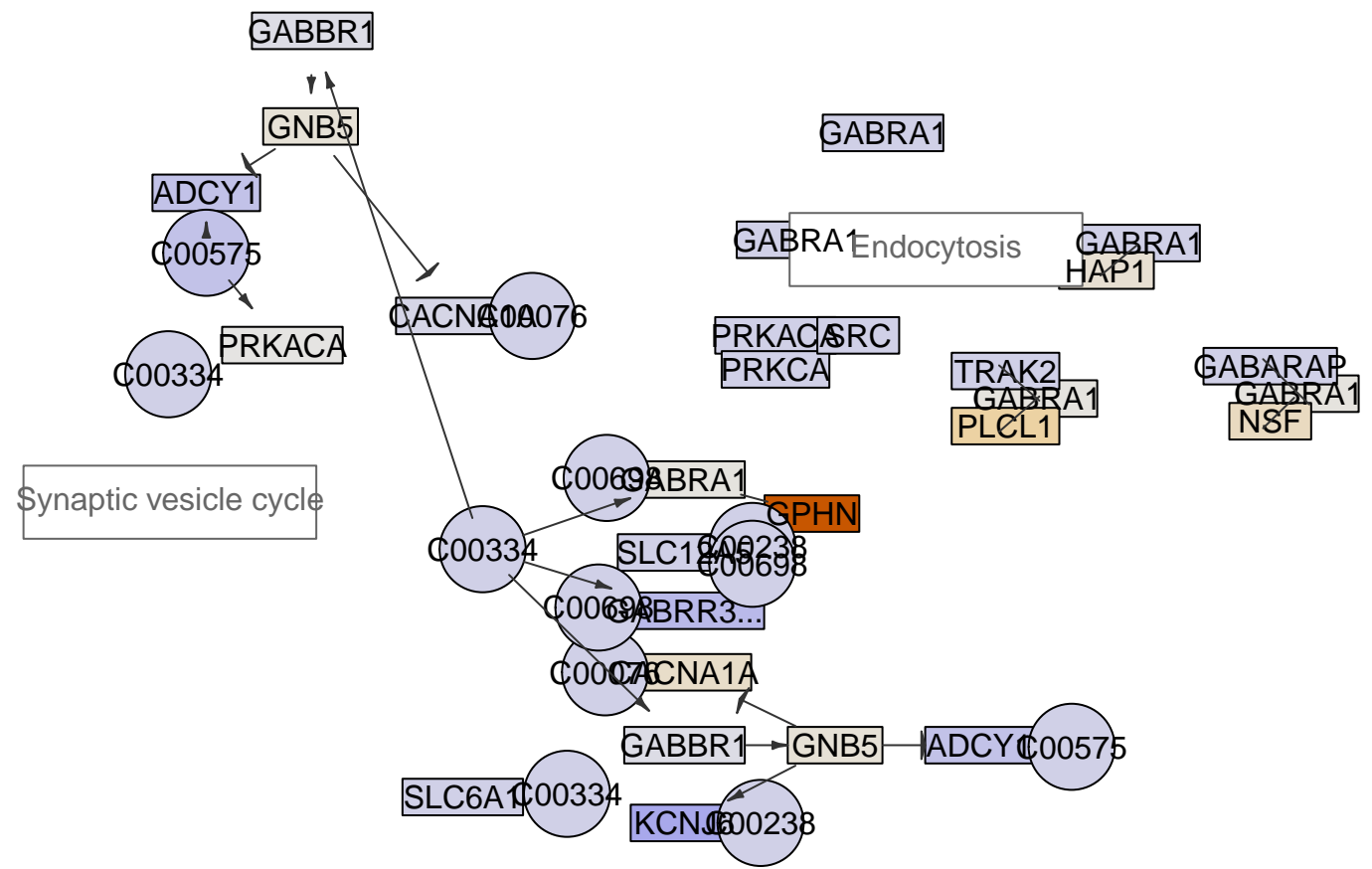
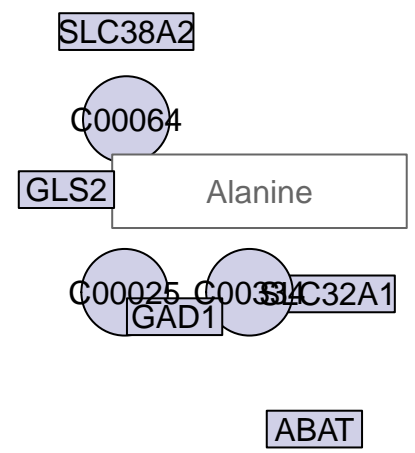

GABAergic synapse
MPI-180

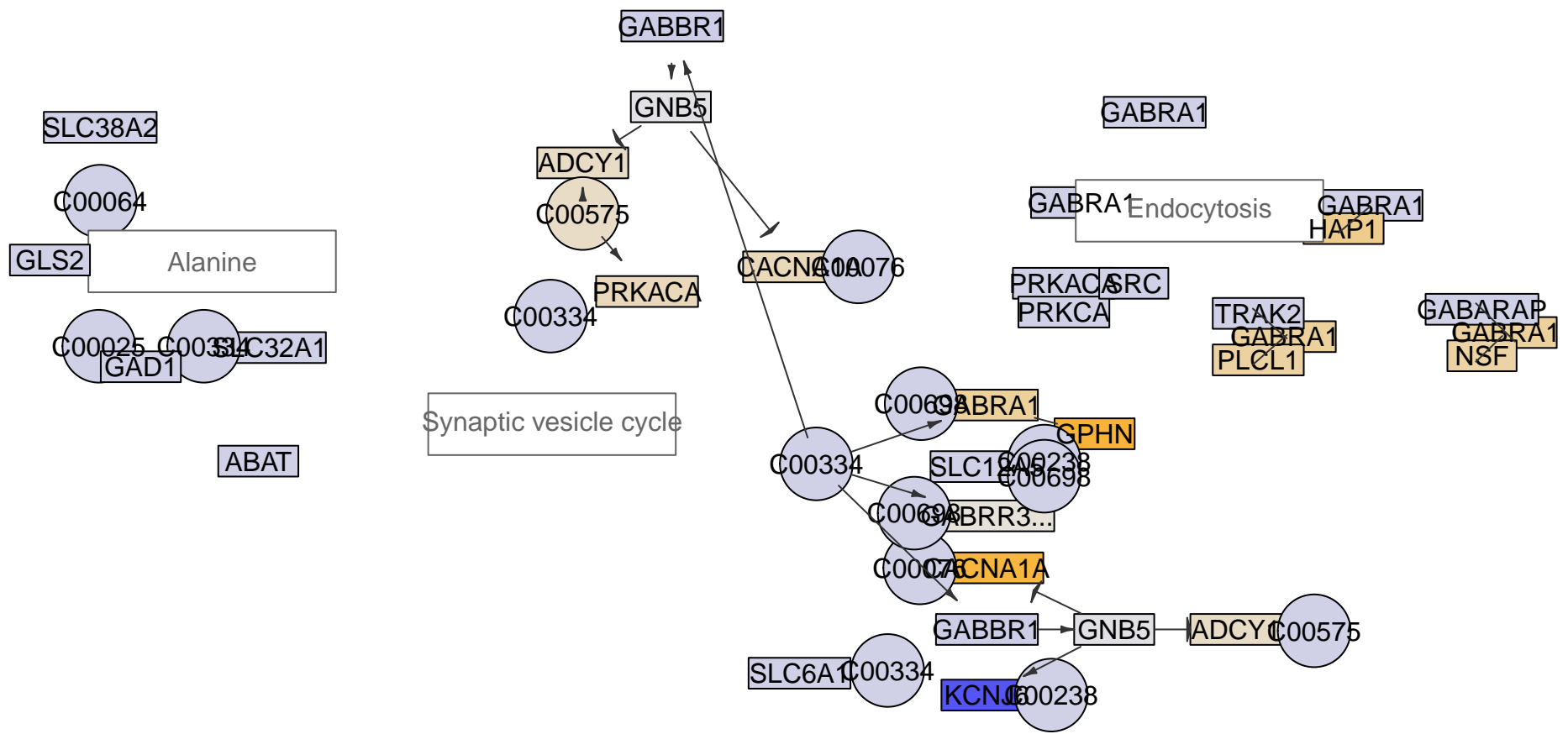
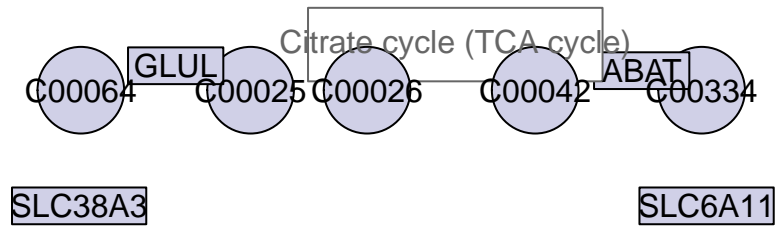

GABAergic synapse
MPI-182

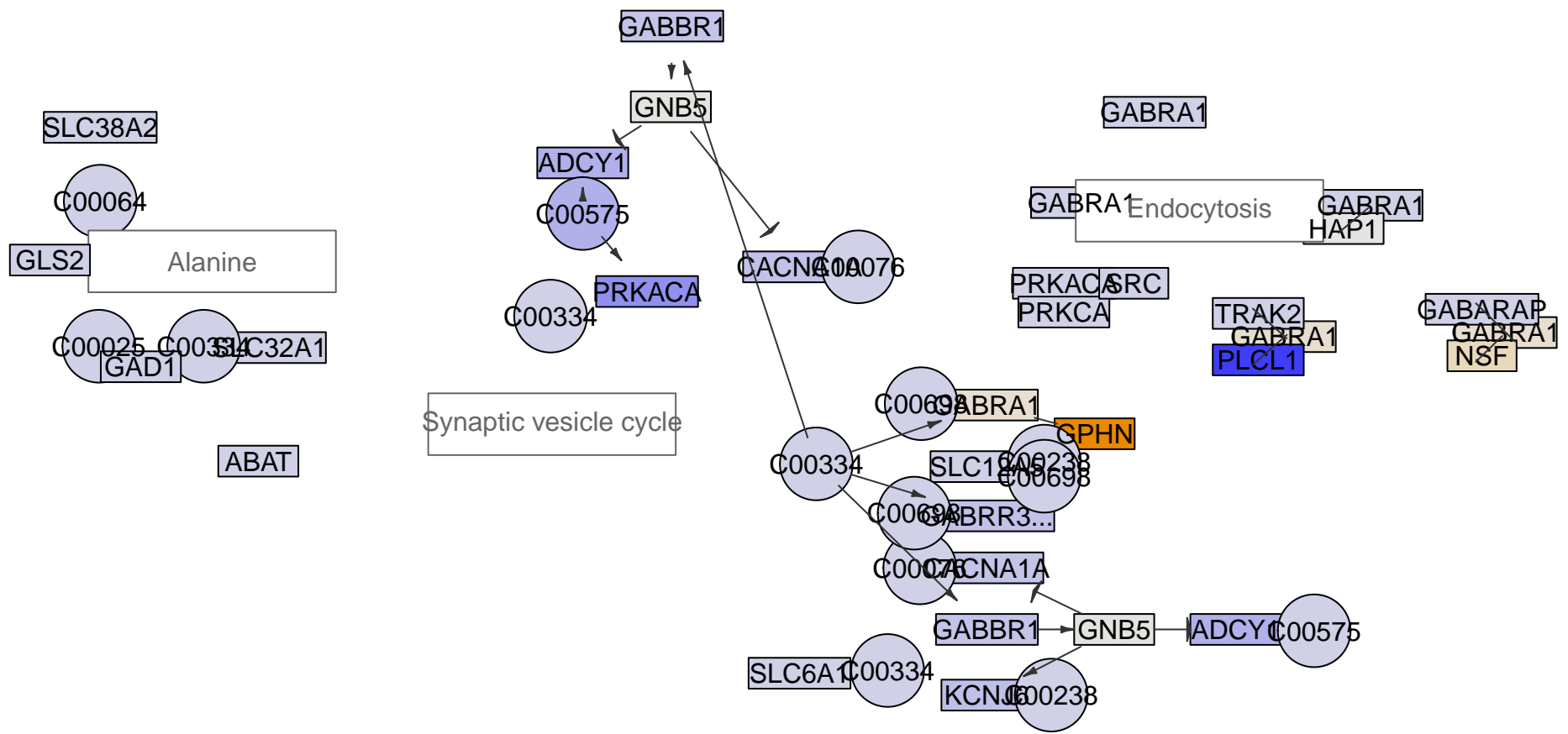

GABAergic synapse
MPI-183

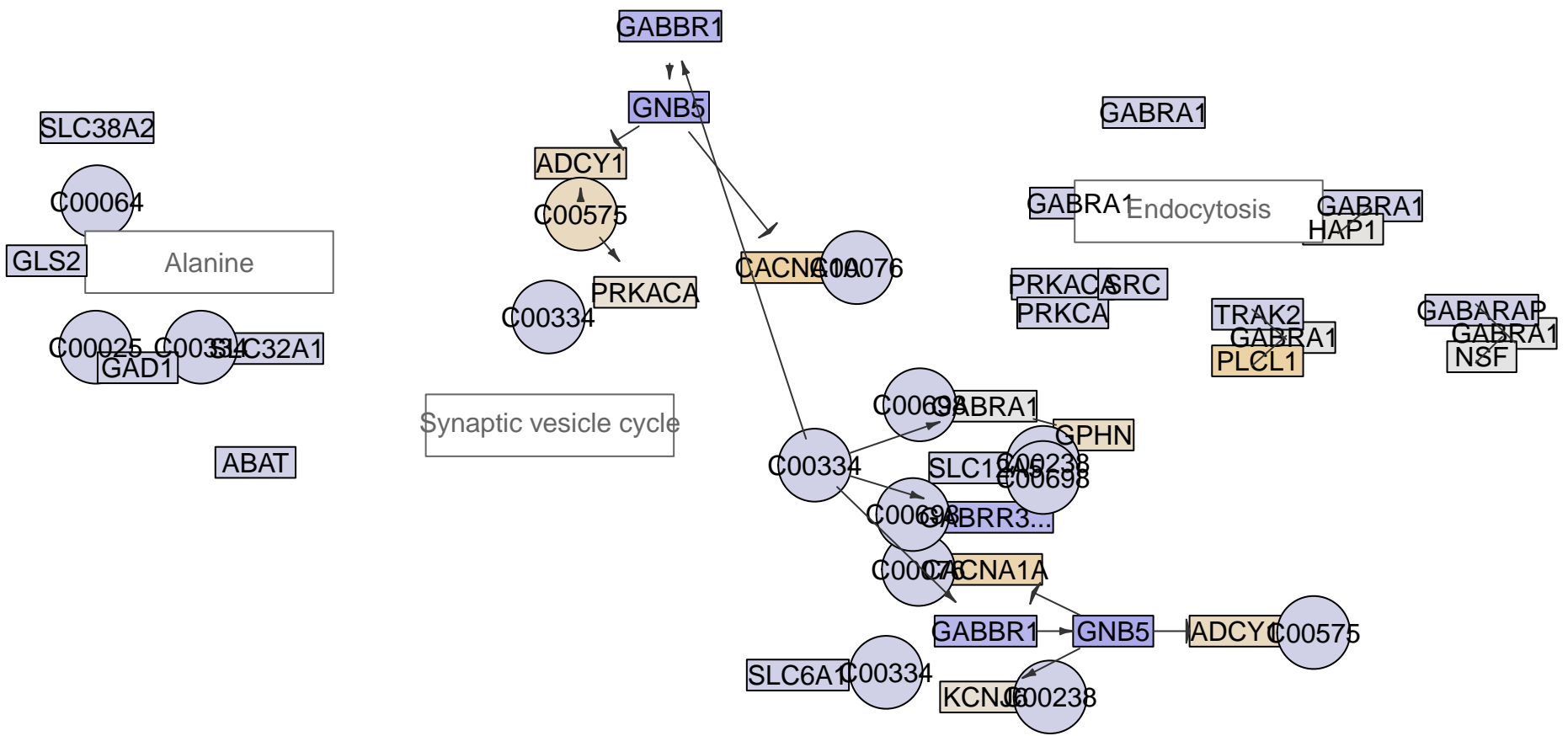

GABAergic synapse
MPI-184

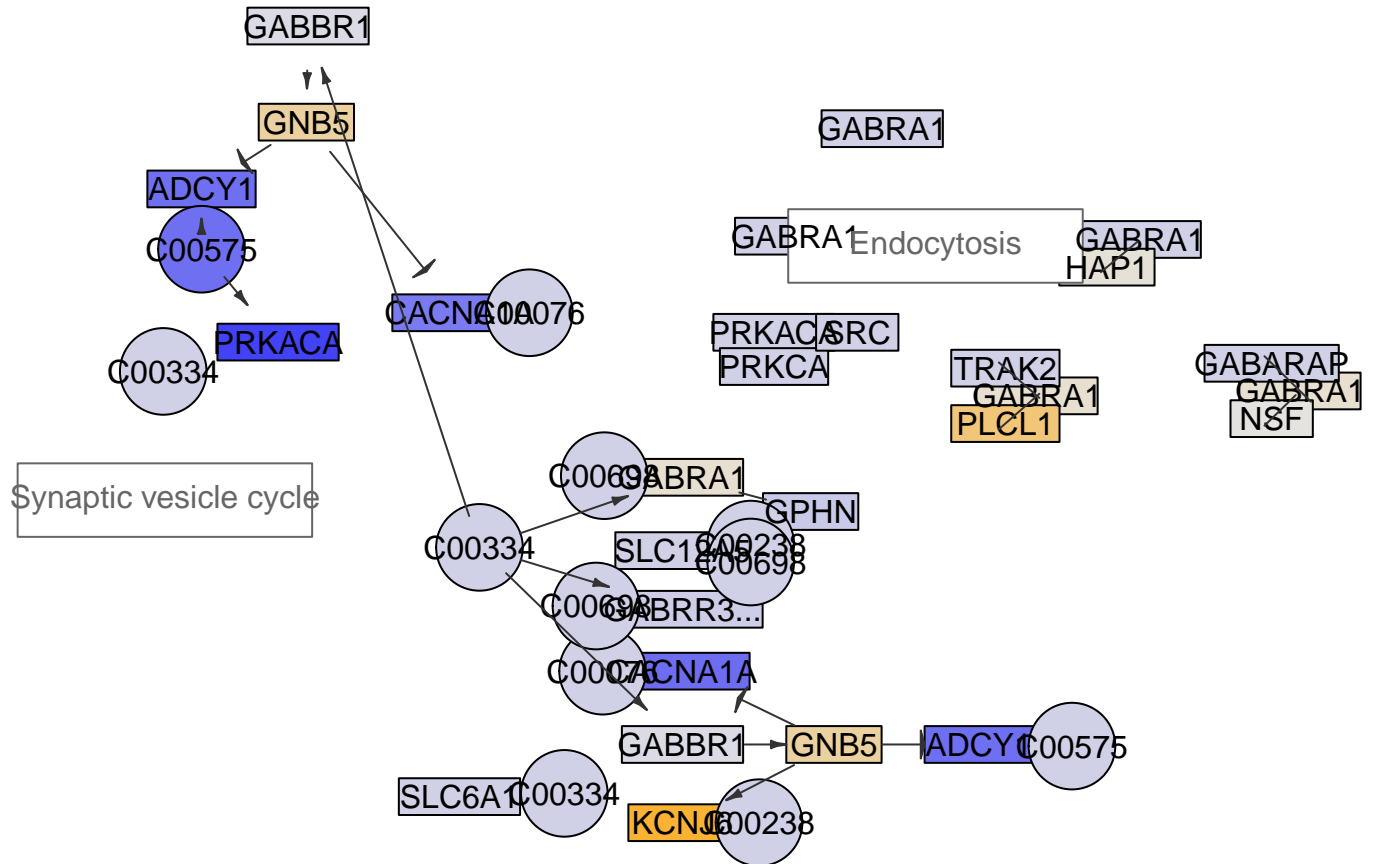
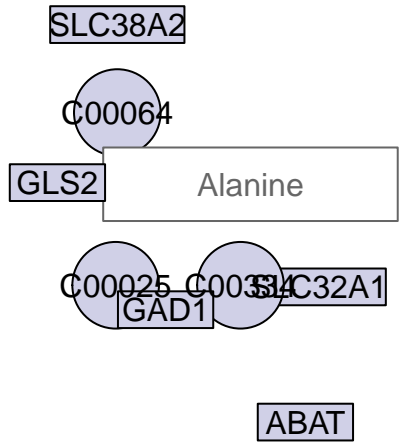

GABAergic synapse
MPI-185

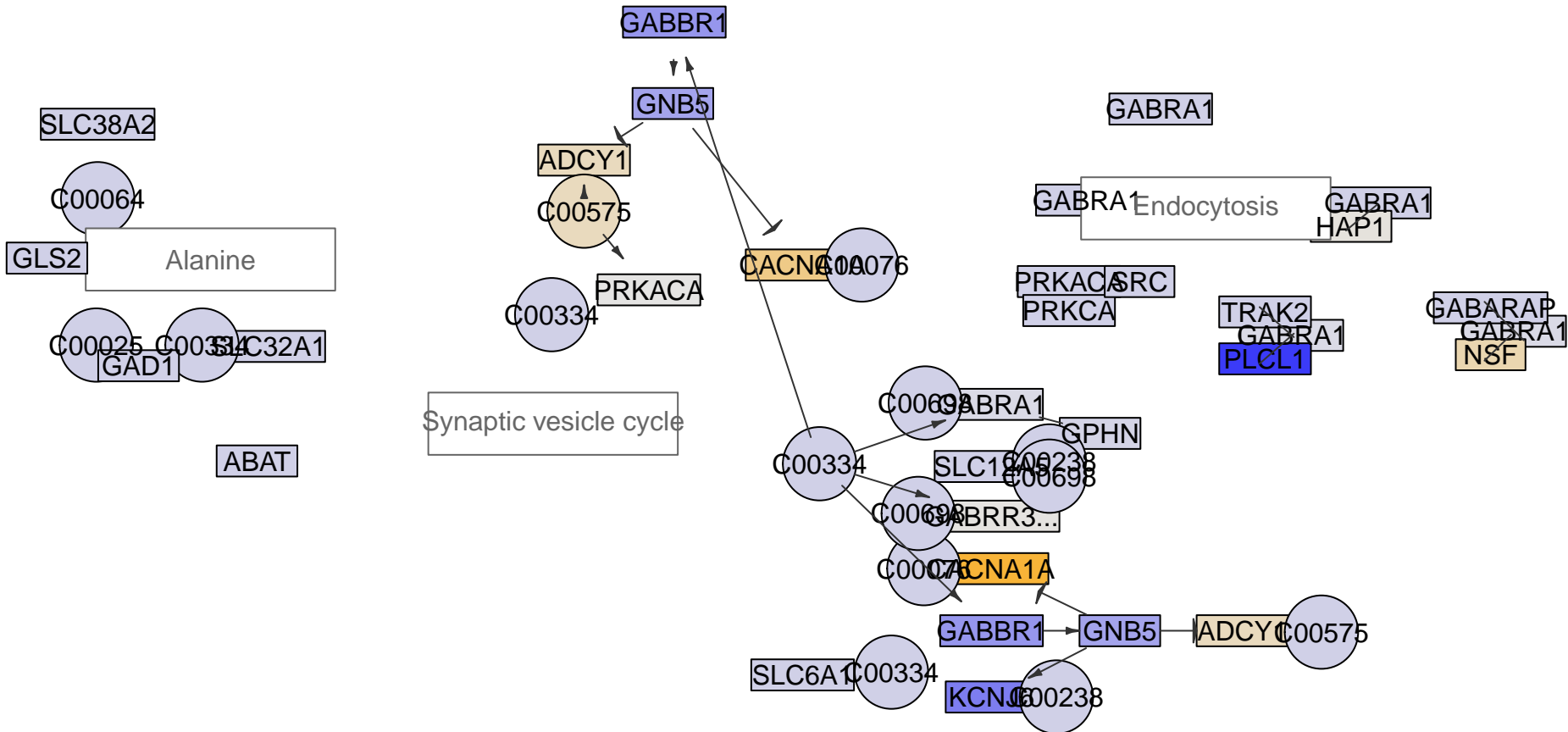
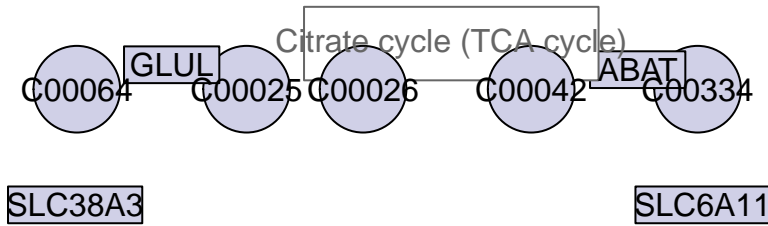

GABAergic synapse
MPI-186

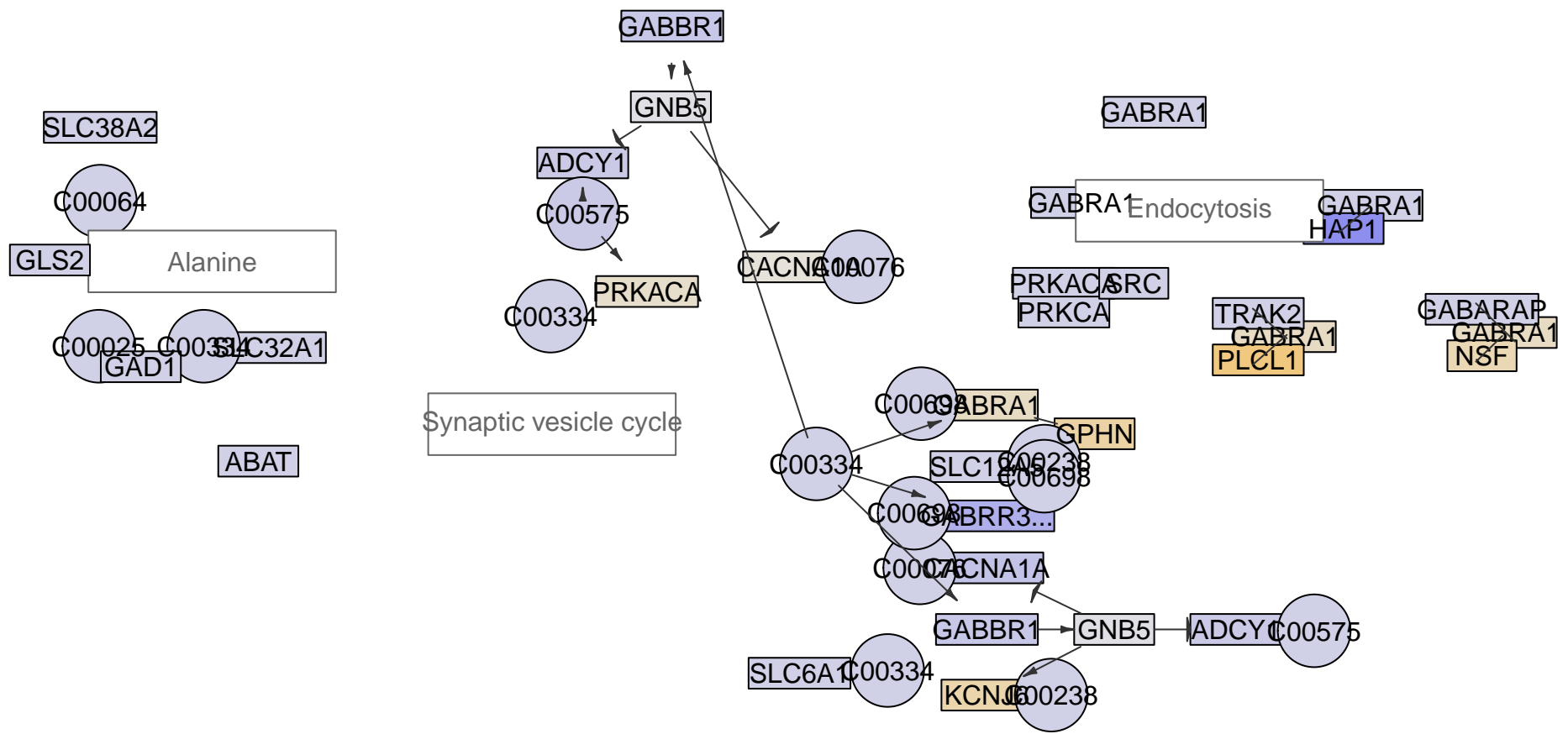

GABAergic synapse
MPI-188

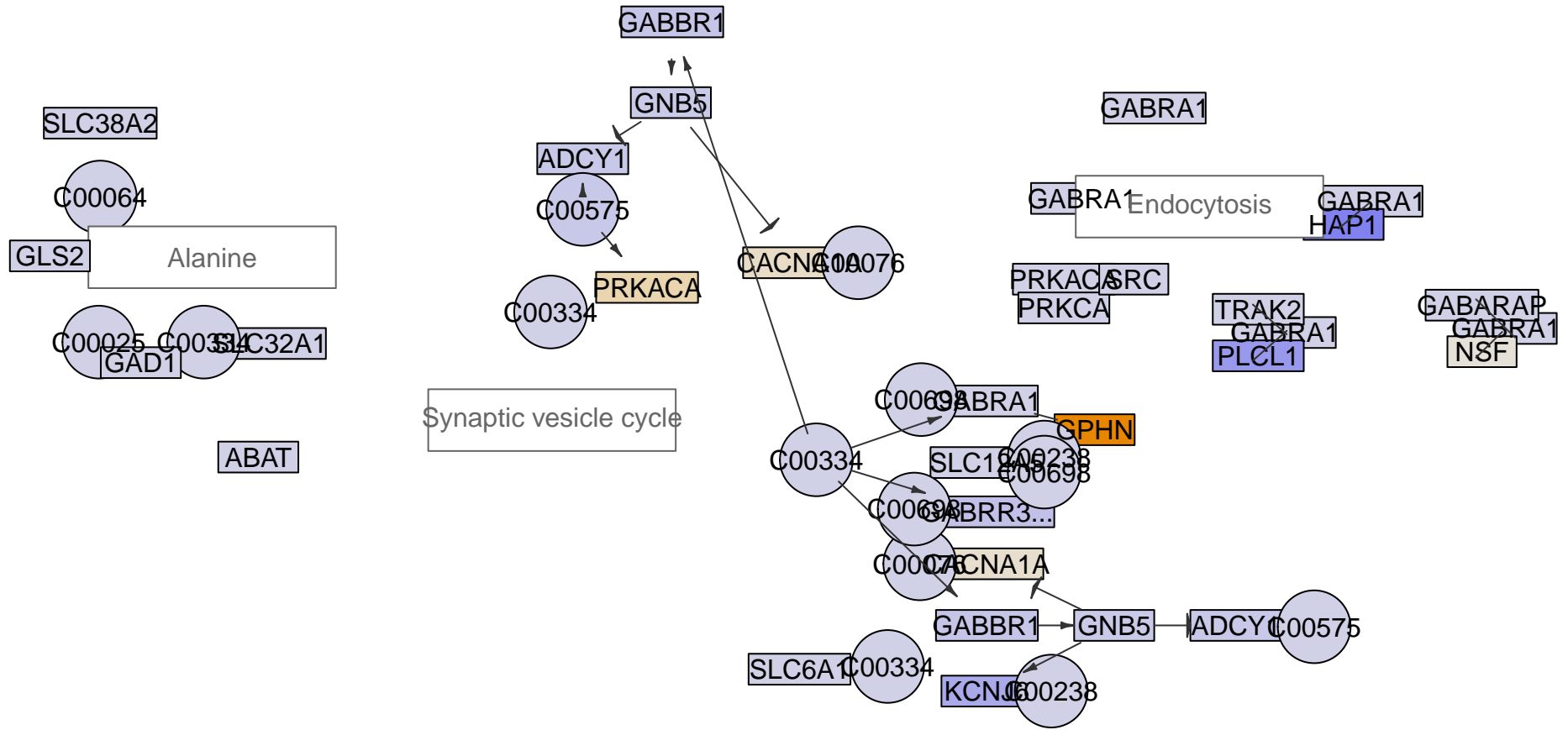

GABAergic synapse
MPI-189

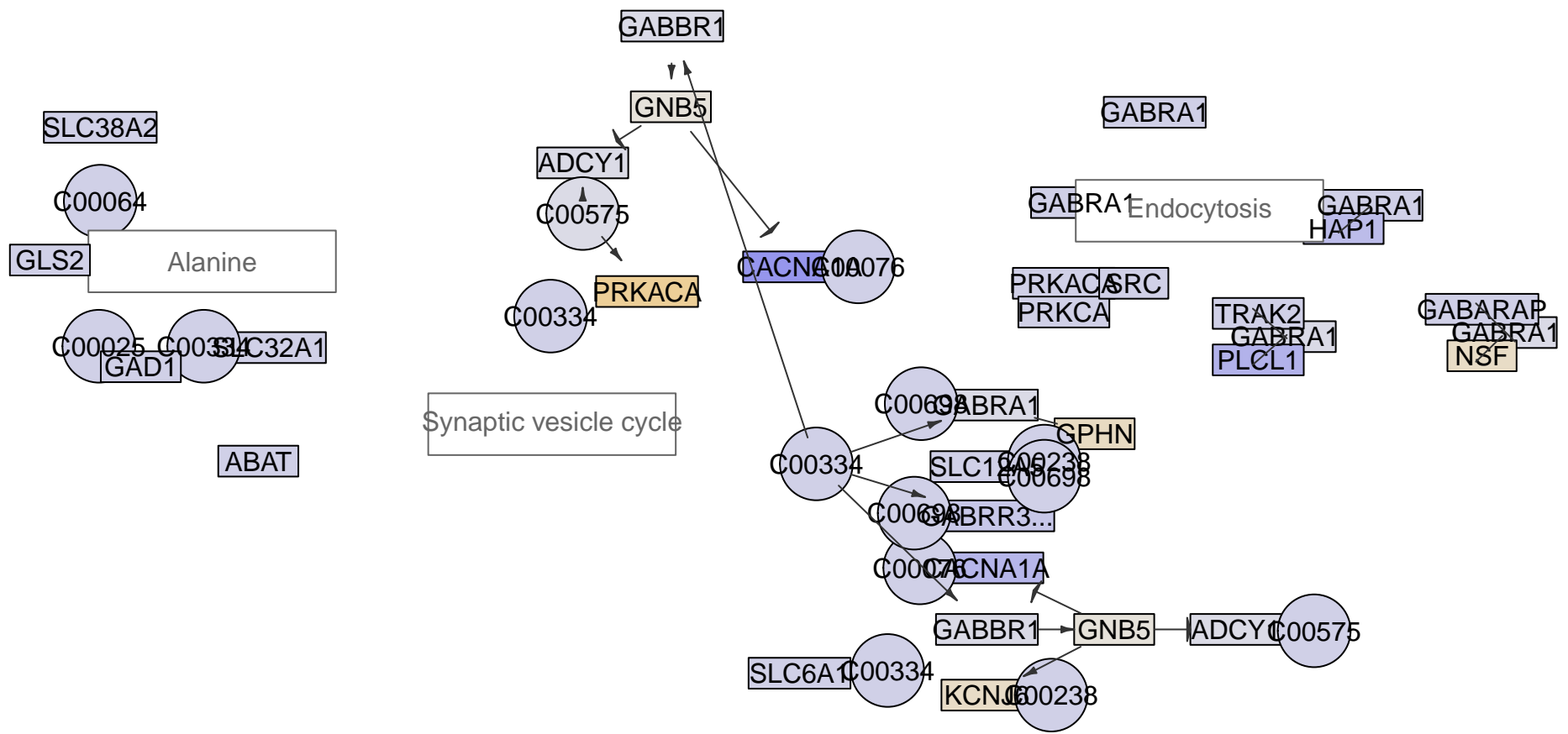

GABAergic synapse
MPI-190

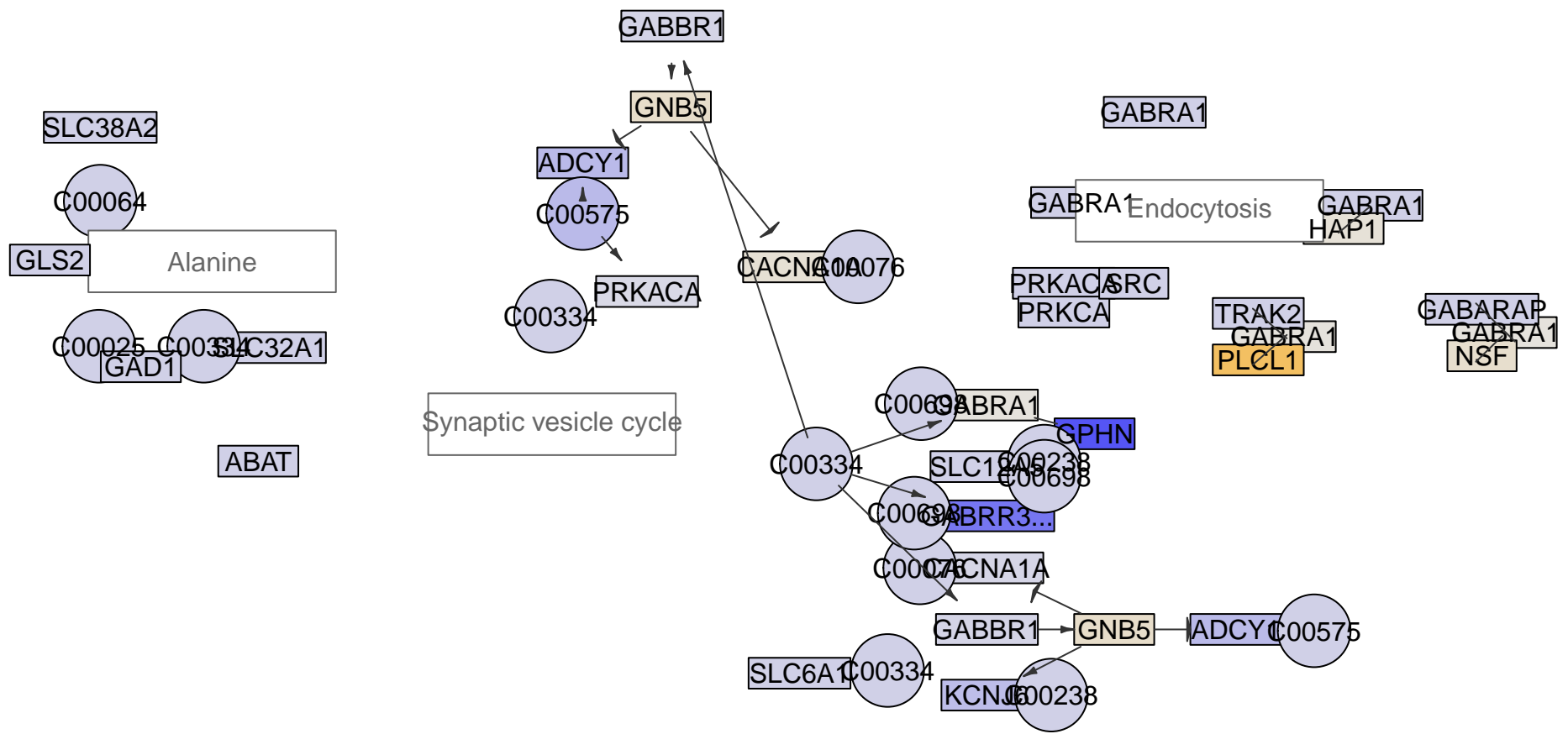

GABAergic synapse
MPI-191

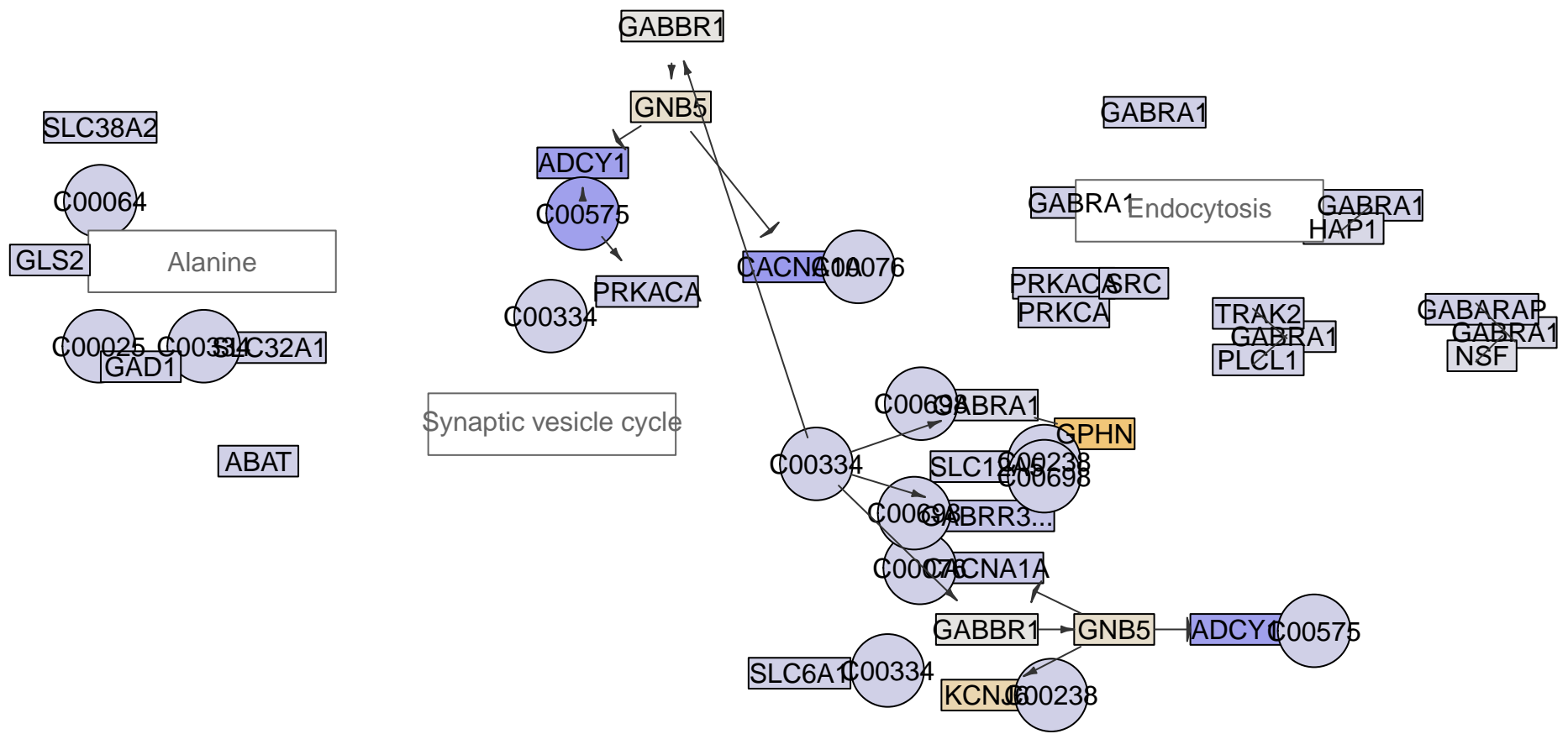

GABAergic synapse
MPI-192

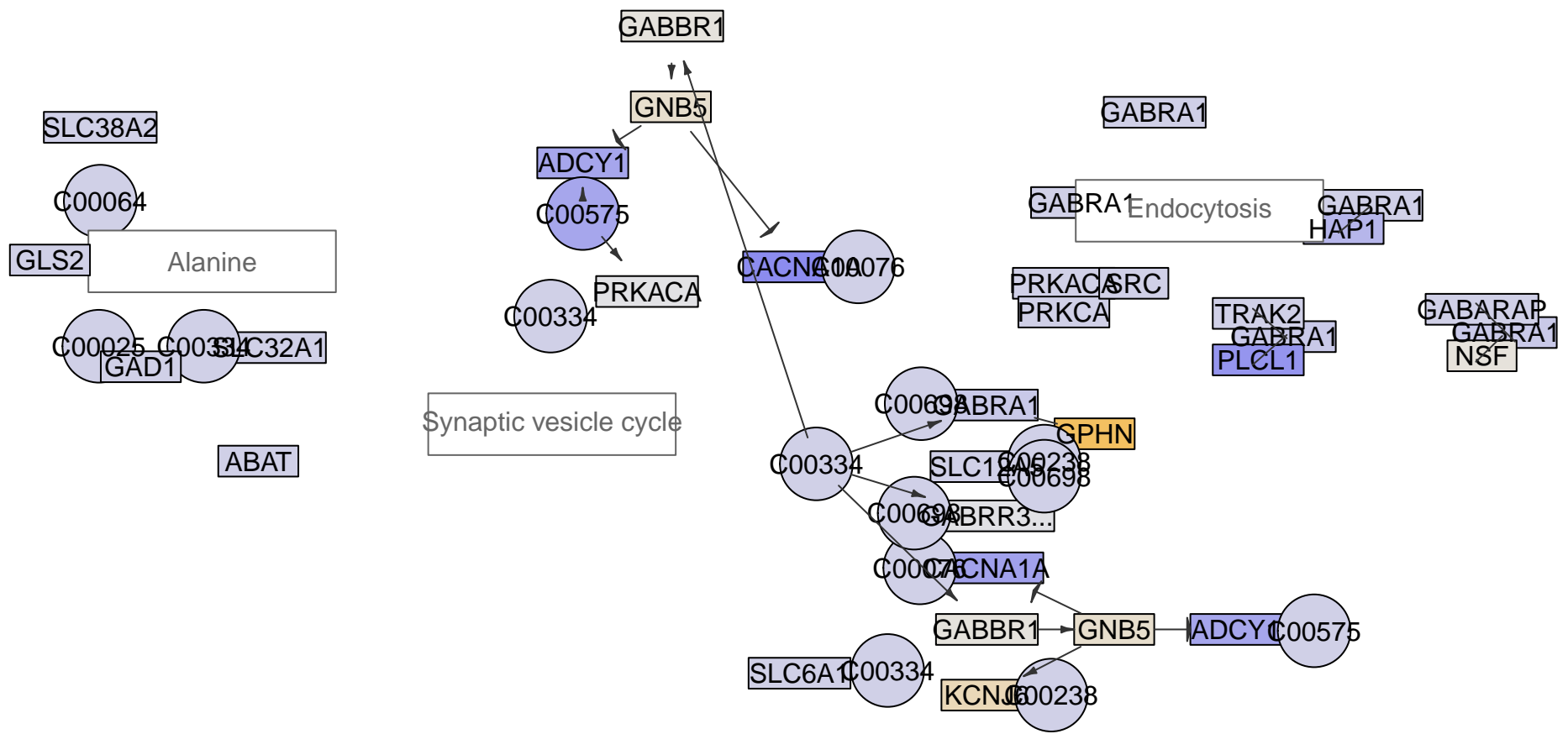

GABAergic synapse
MPI-194

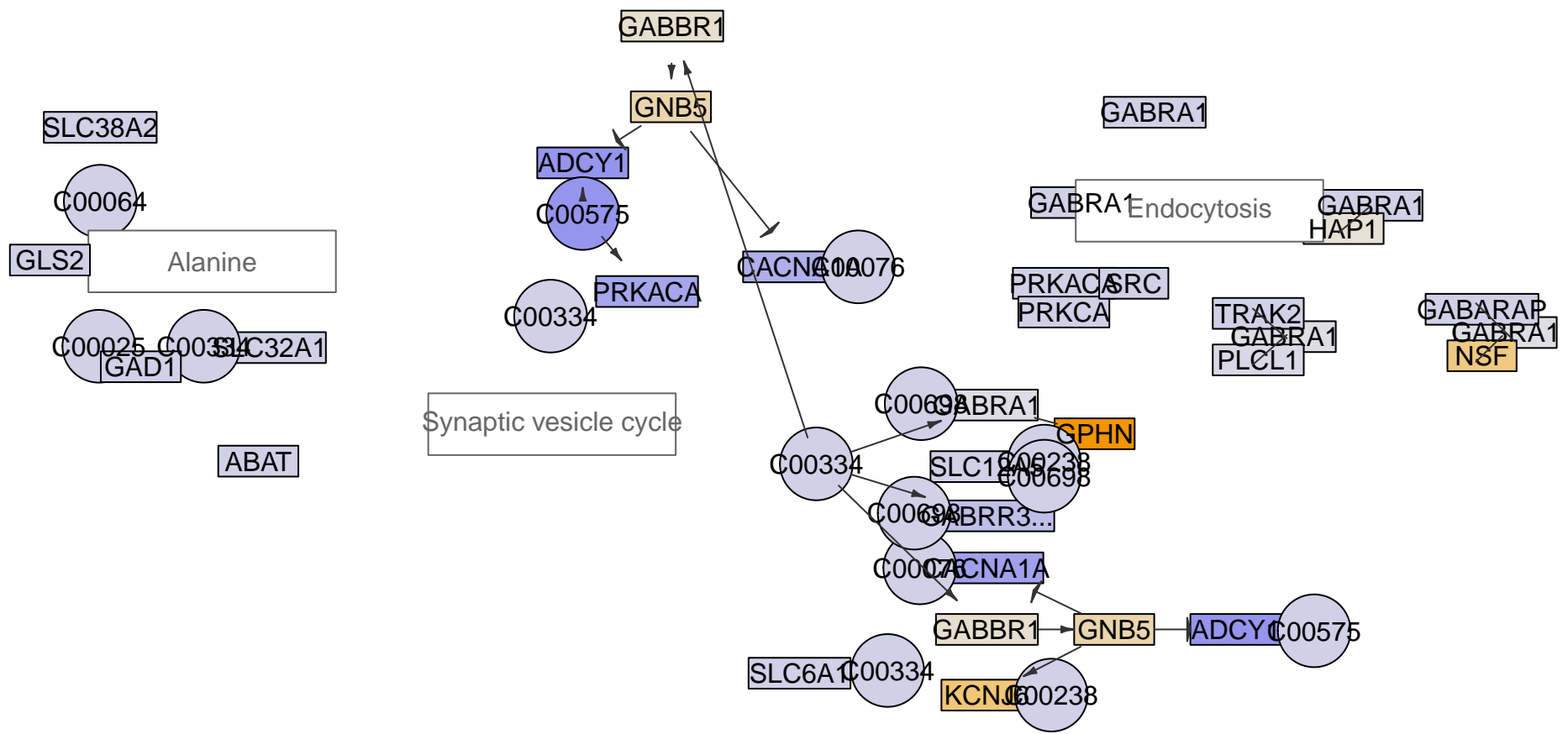

GABAergic synapse MPI-195

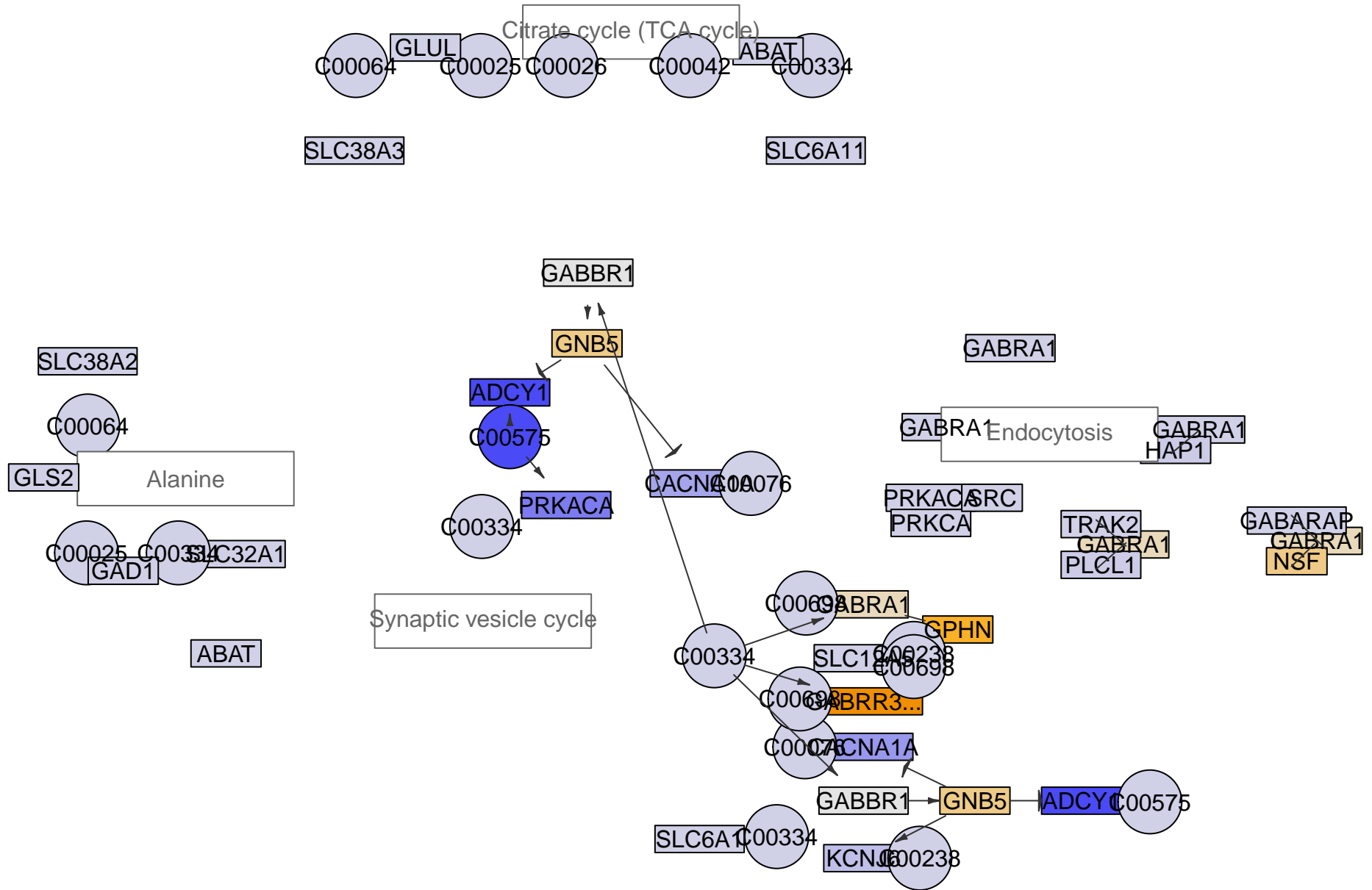

GABAergic synapse
MPI-196

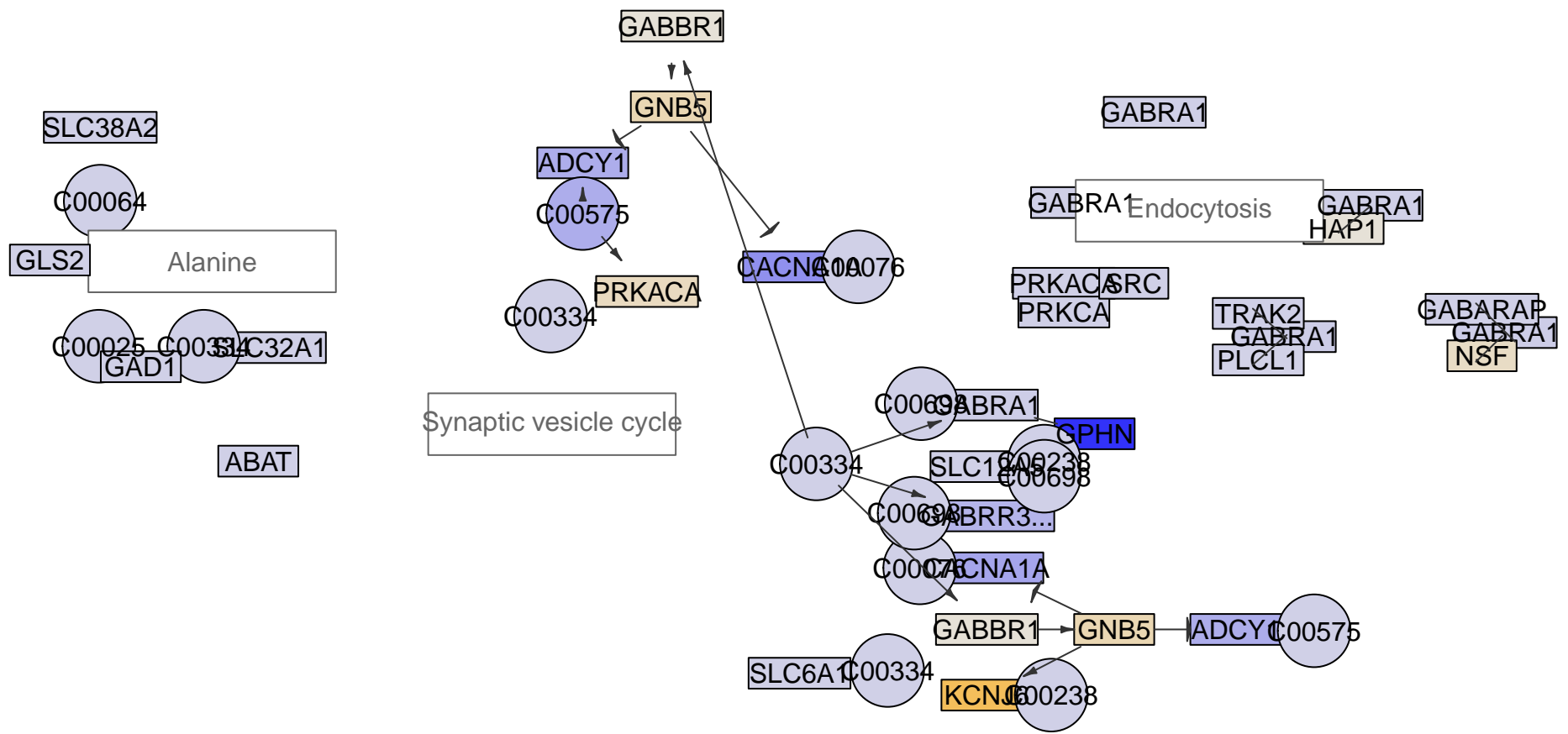

GABAergic synapse
MPI-199

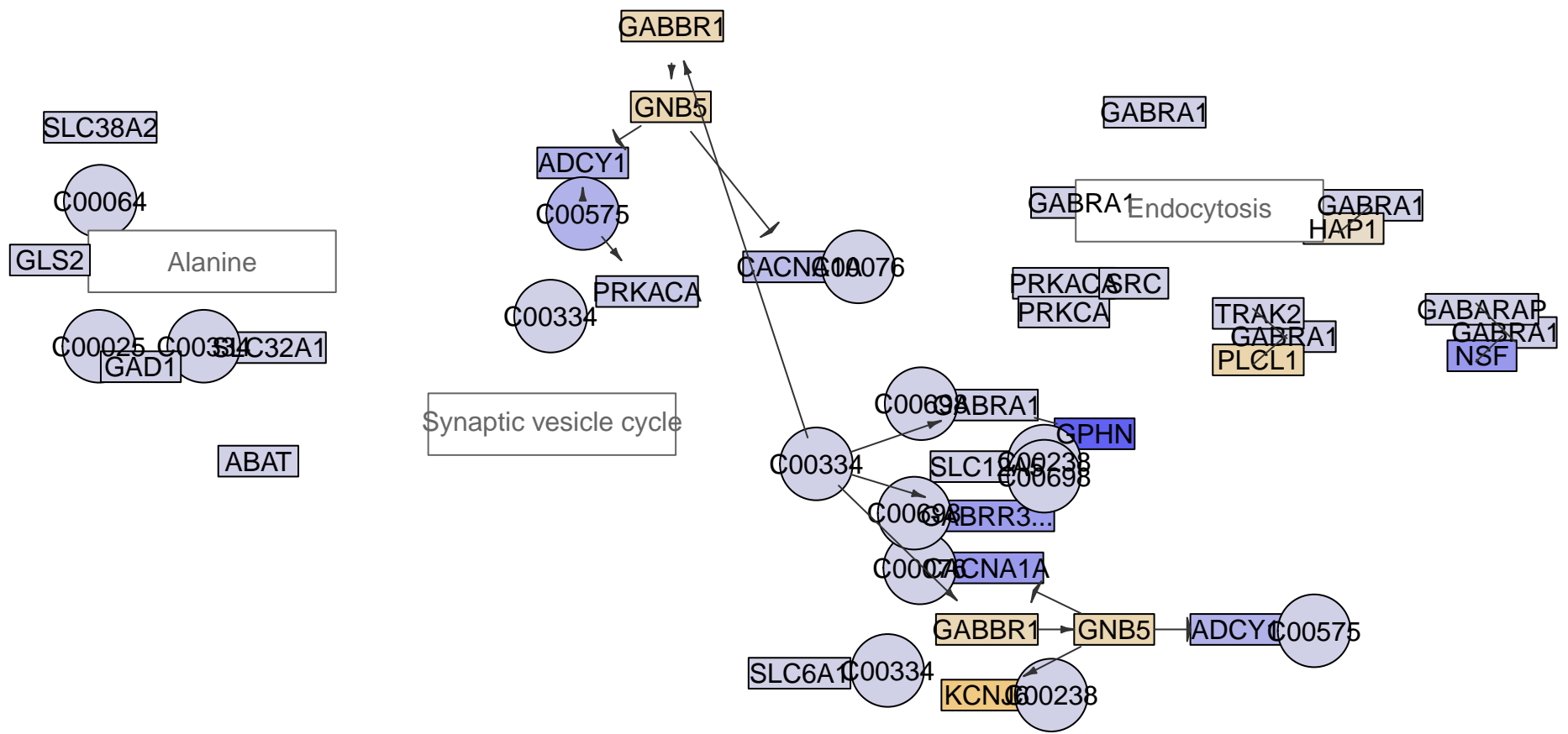

GABAergic synapse
MPI-200

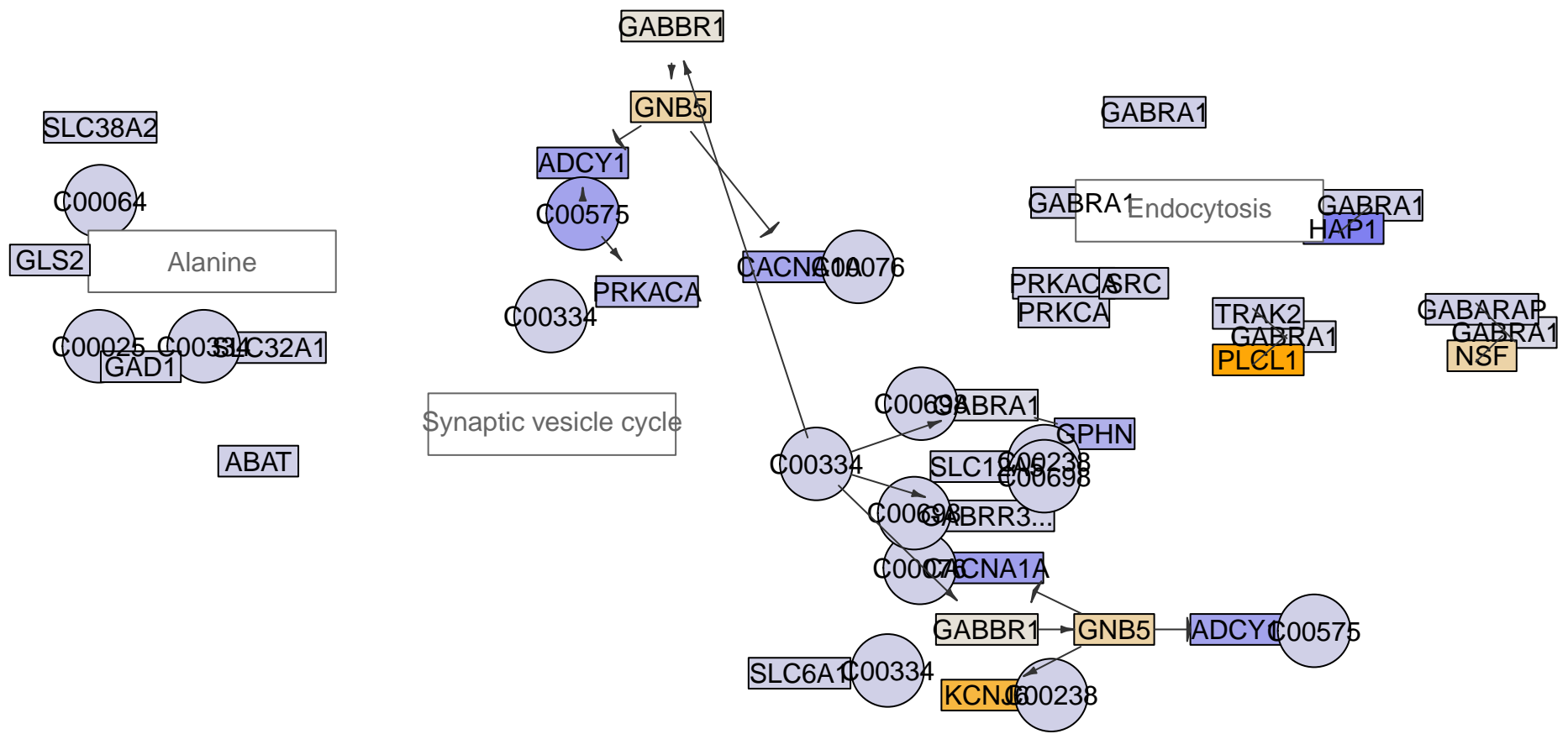

GABAergic synapse
MPI-201

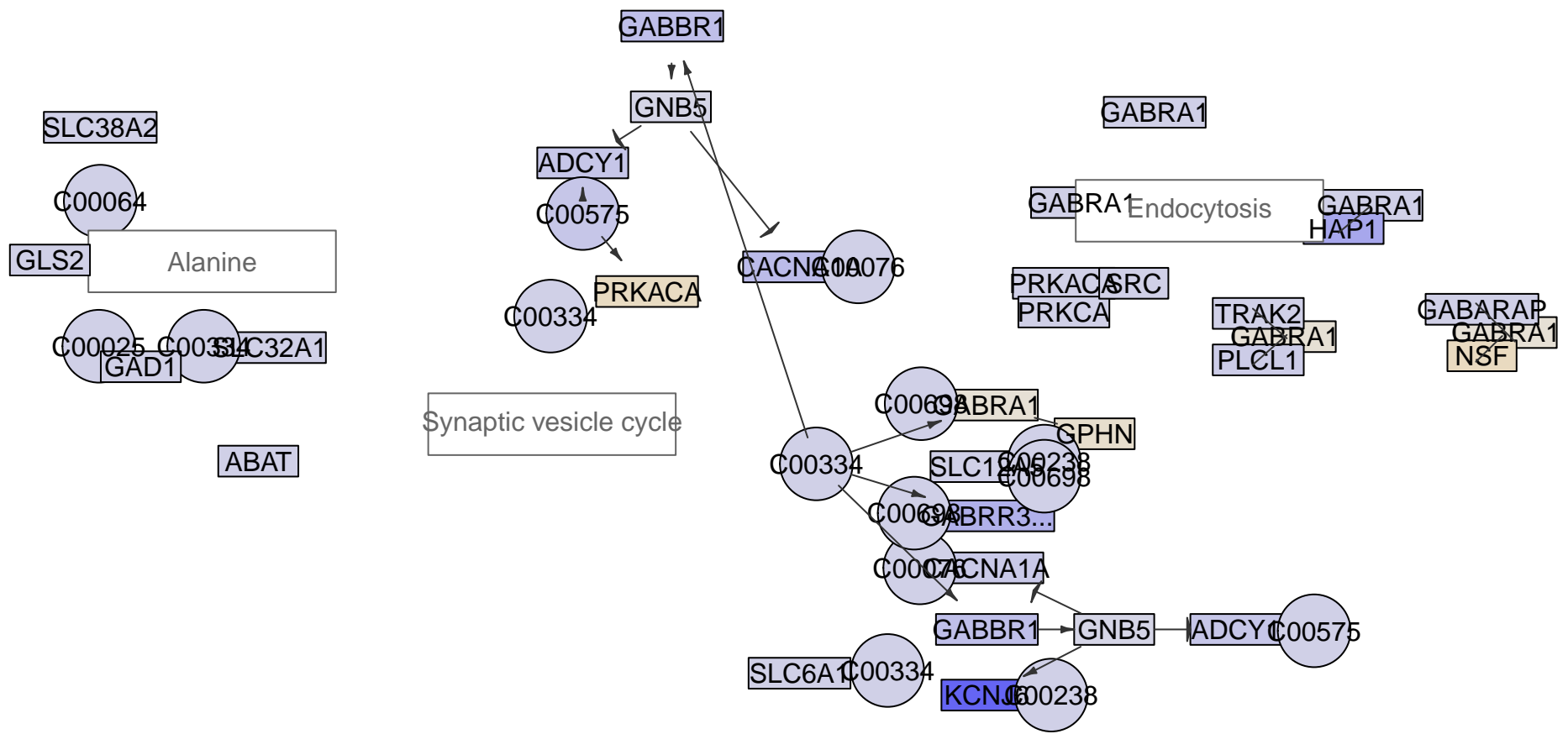

GABAergic synapse
MPI-202

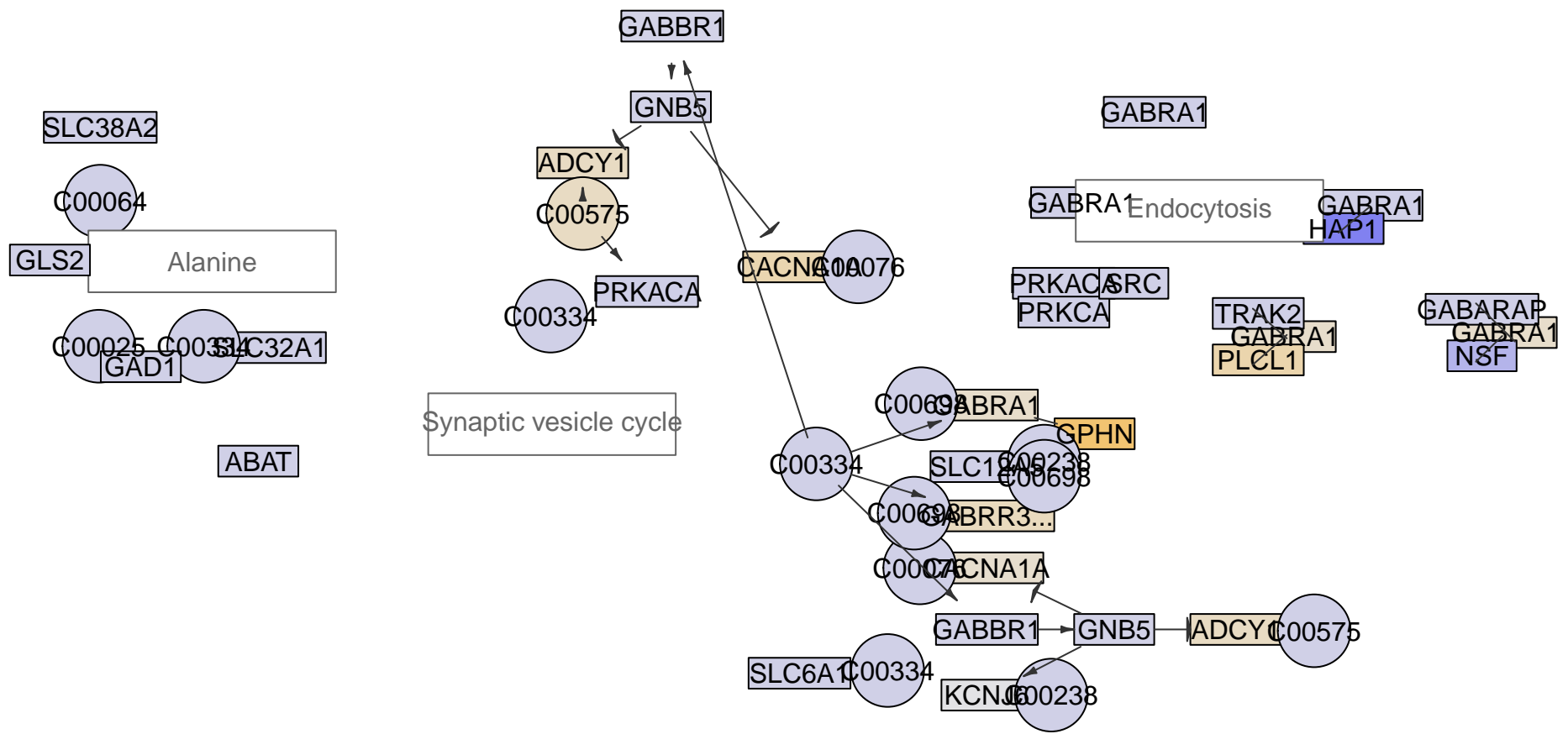

GABAergic synapse
MPI-203

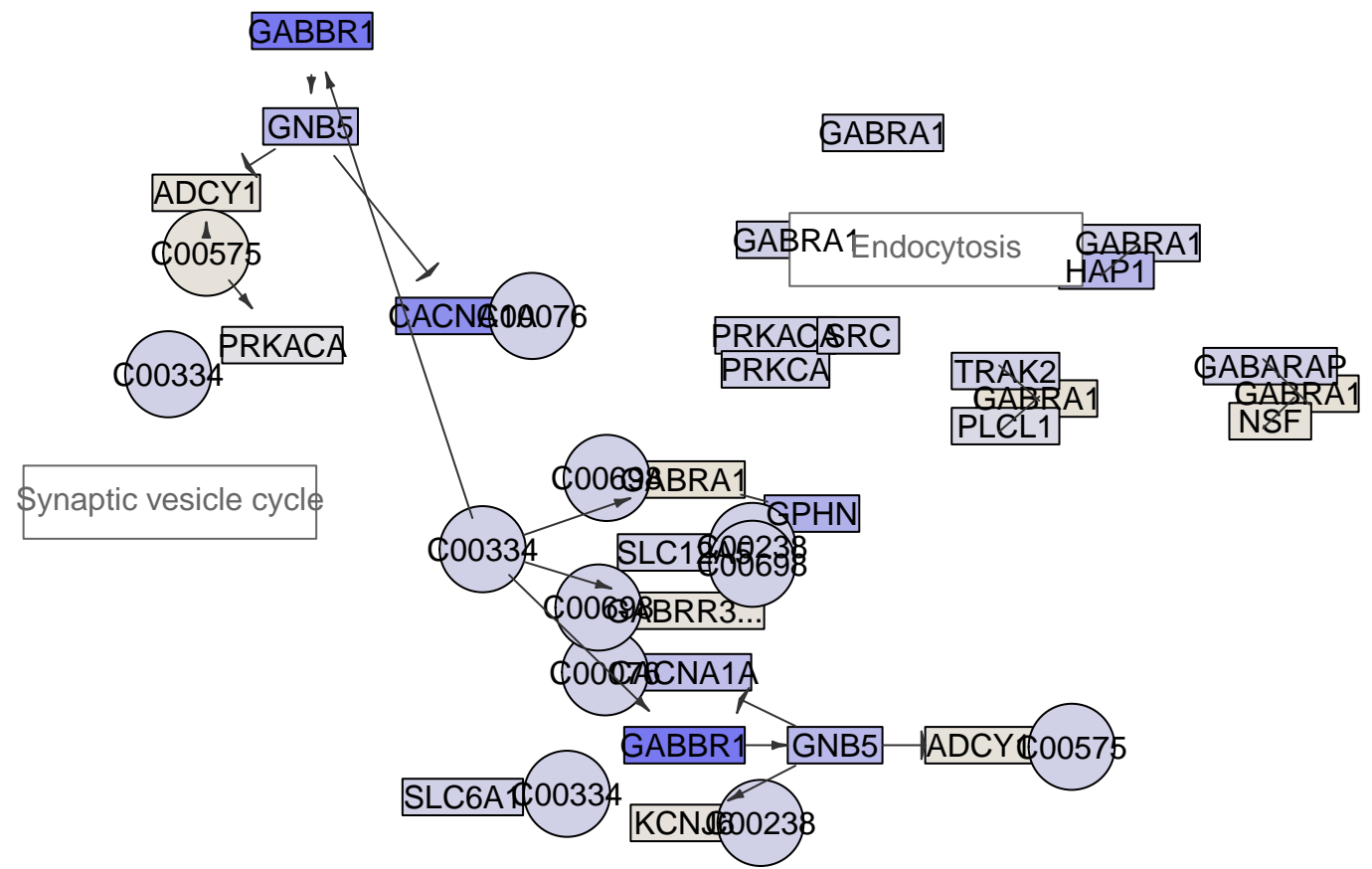
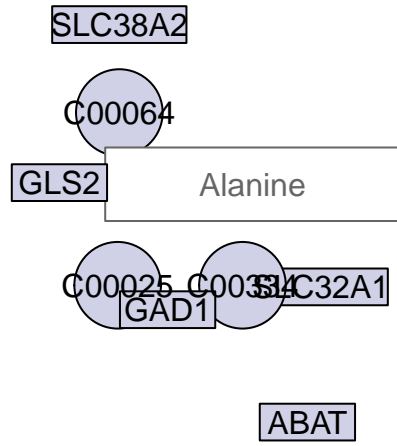

GABAergic synapse
MPI-204

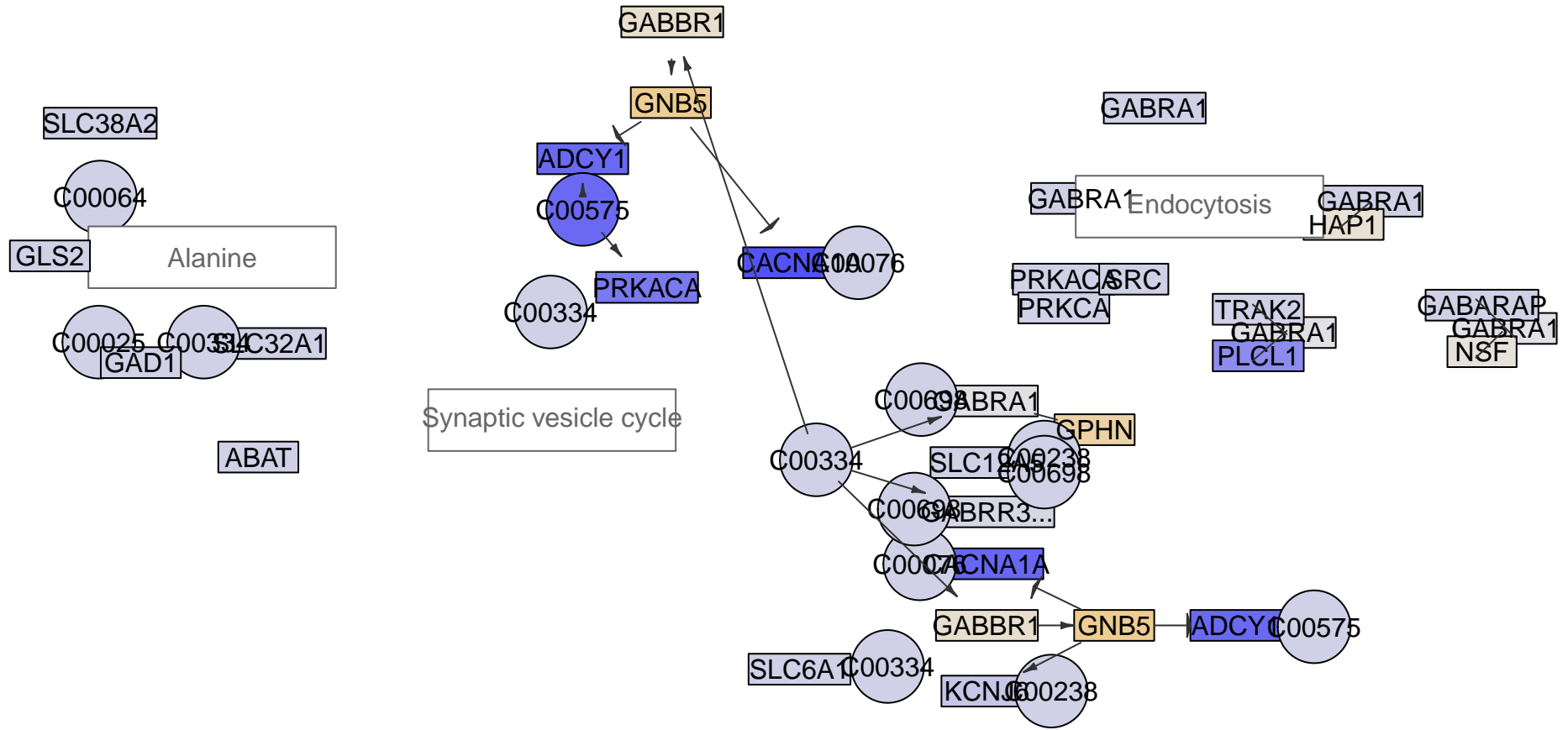

GABAergic synapse
MPI-205

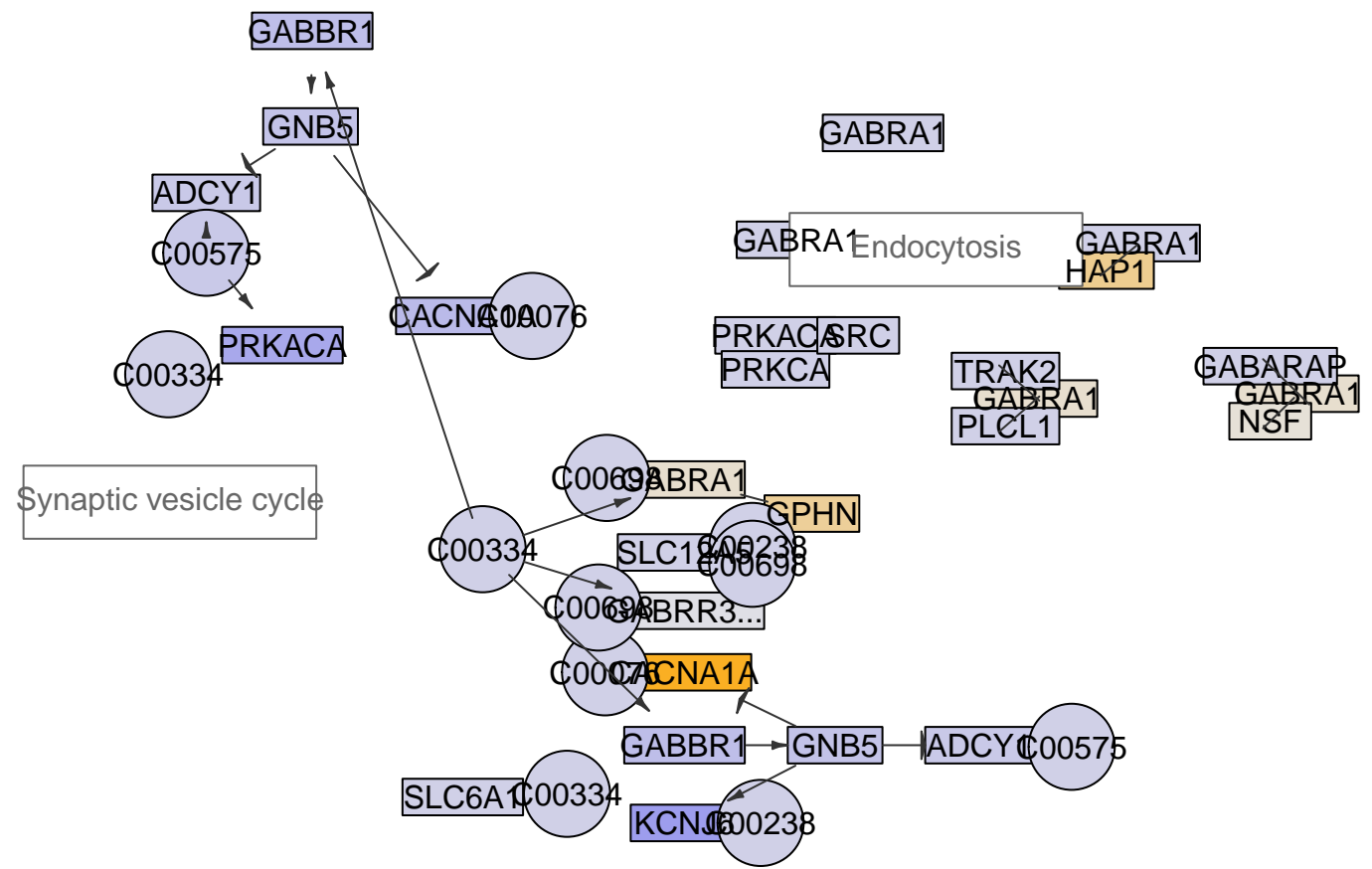
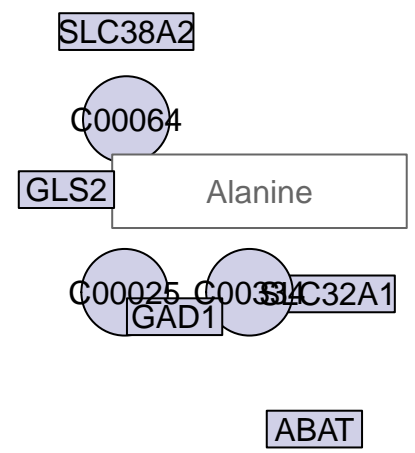

GABAergic synapse
MPI-206

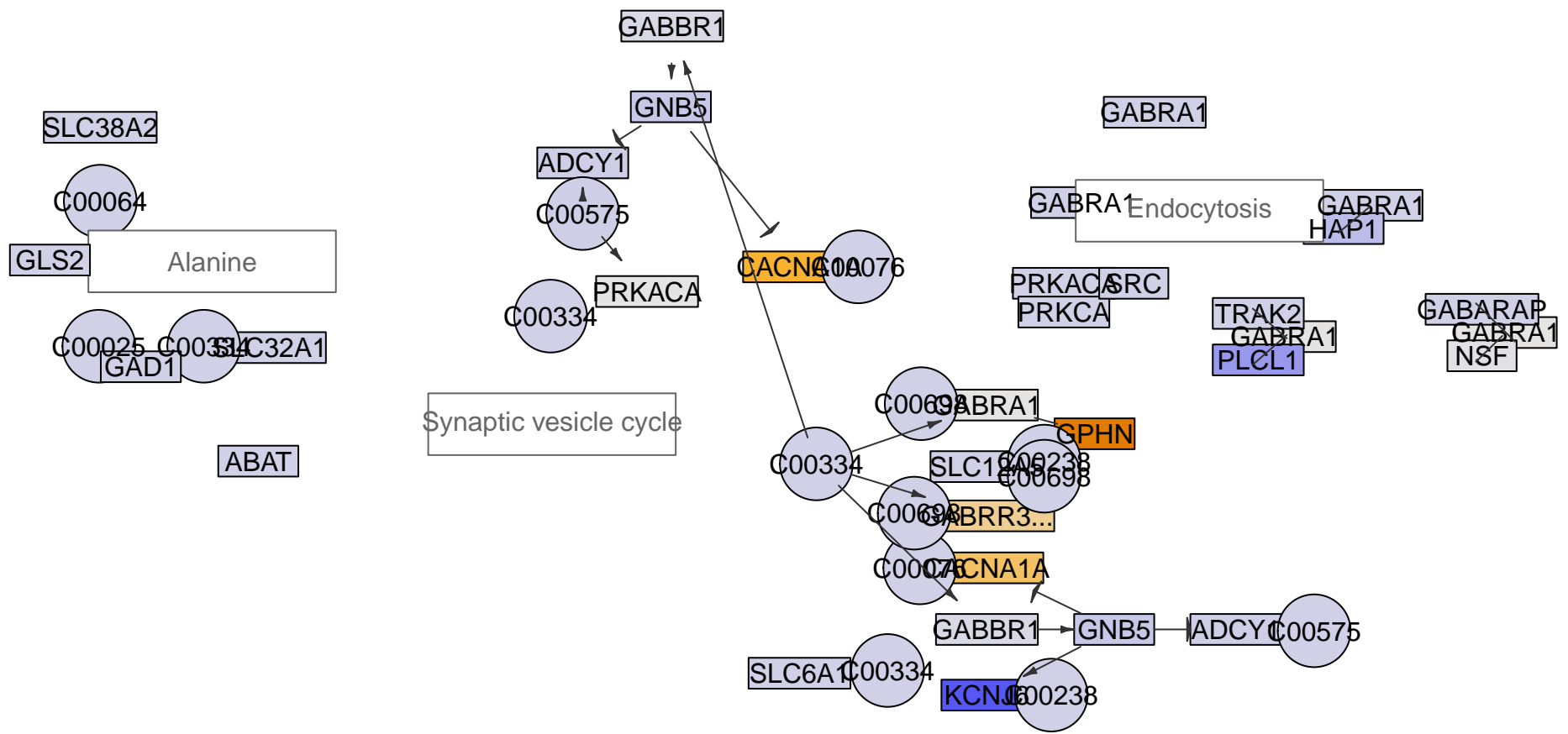

GABAergic synapse
MPI-207

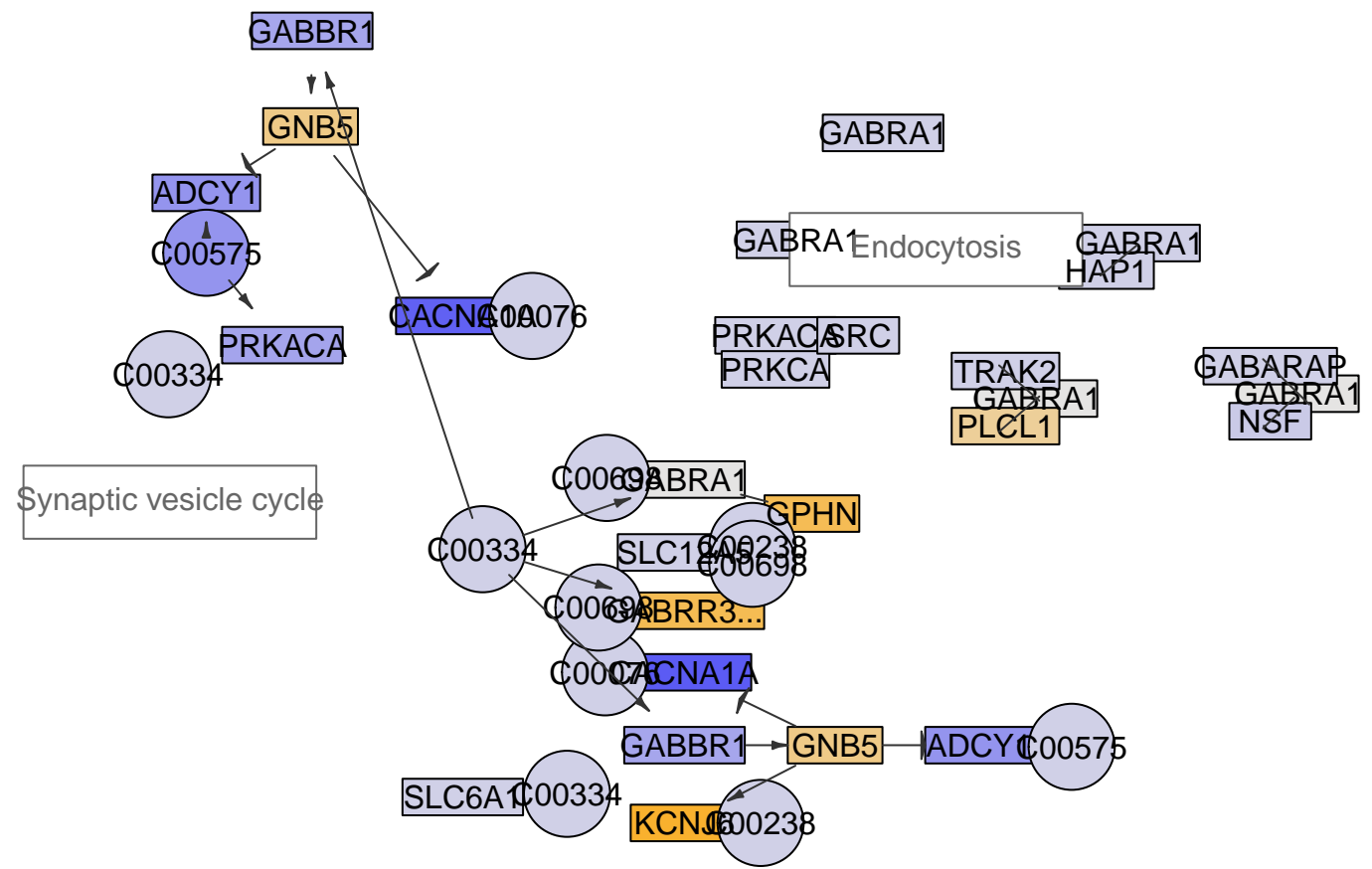
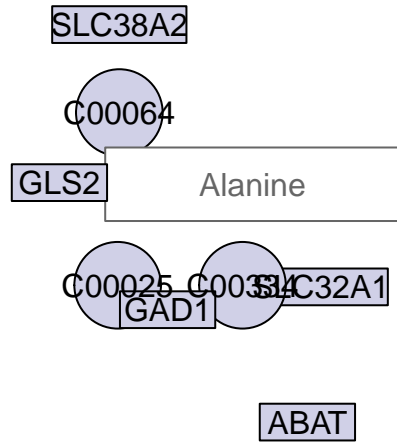

GABAergic synapse
MPI-208

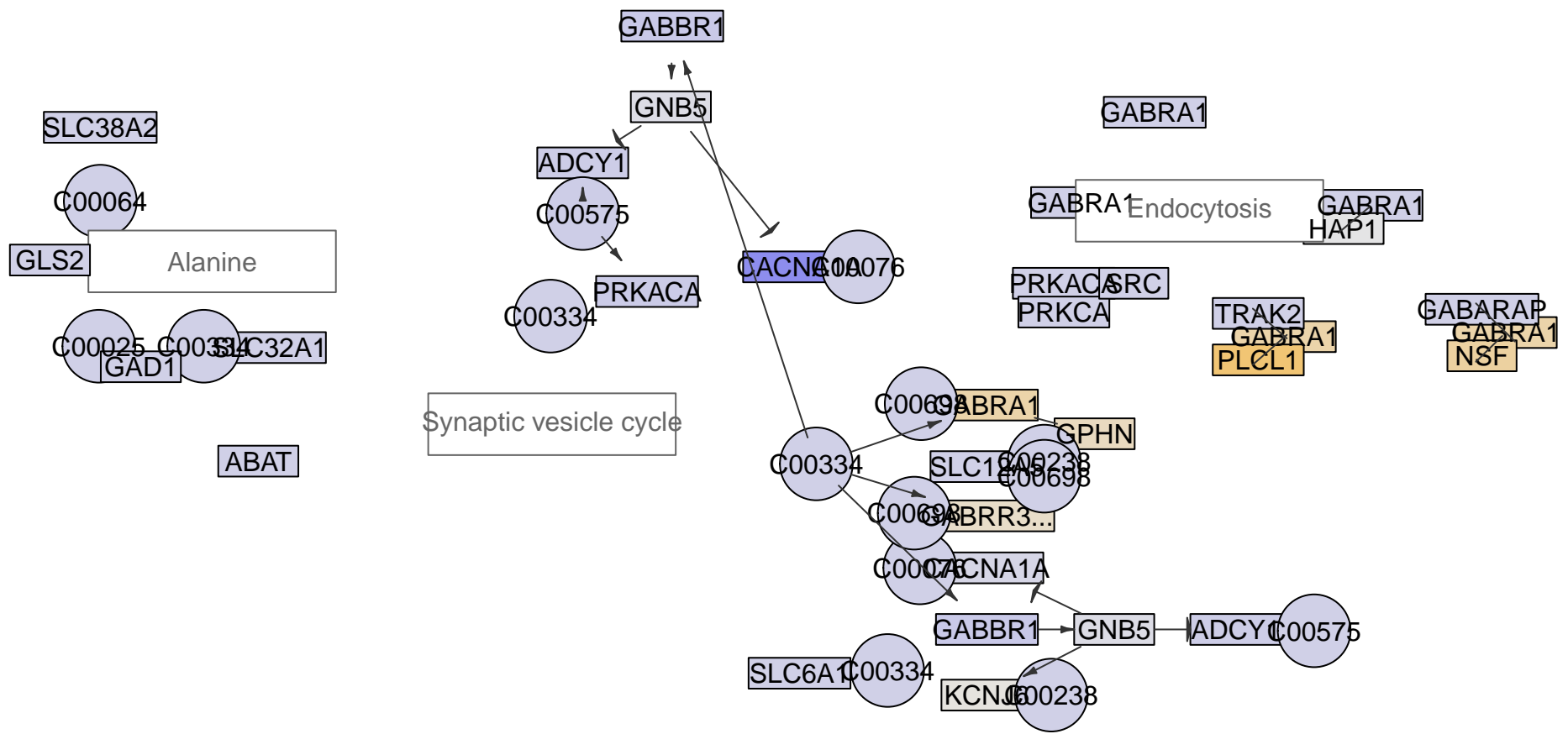

GABAergic synapse
MPI-209

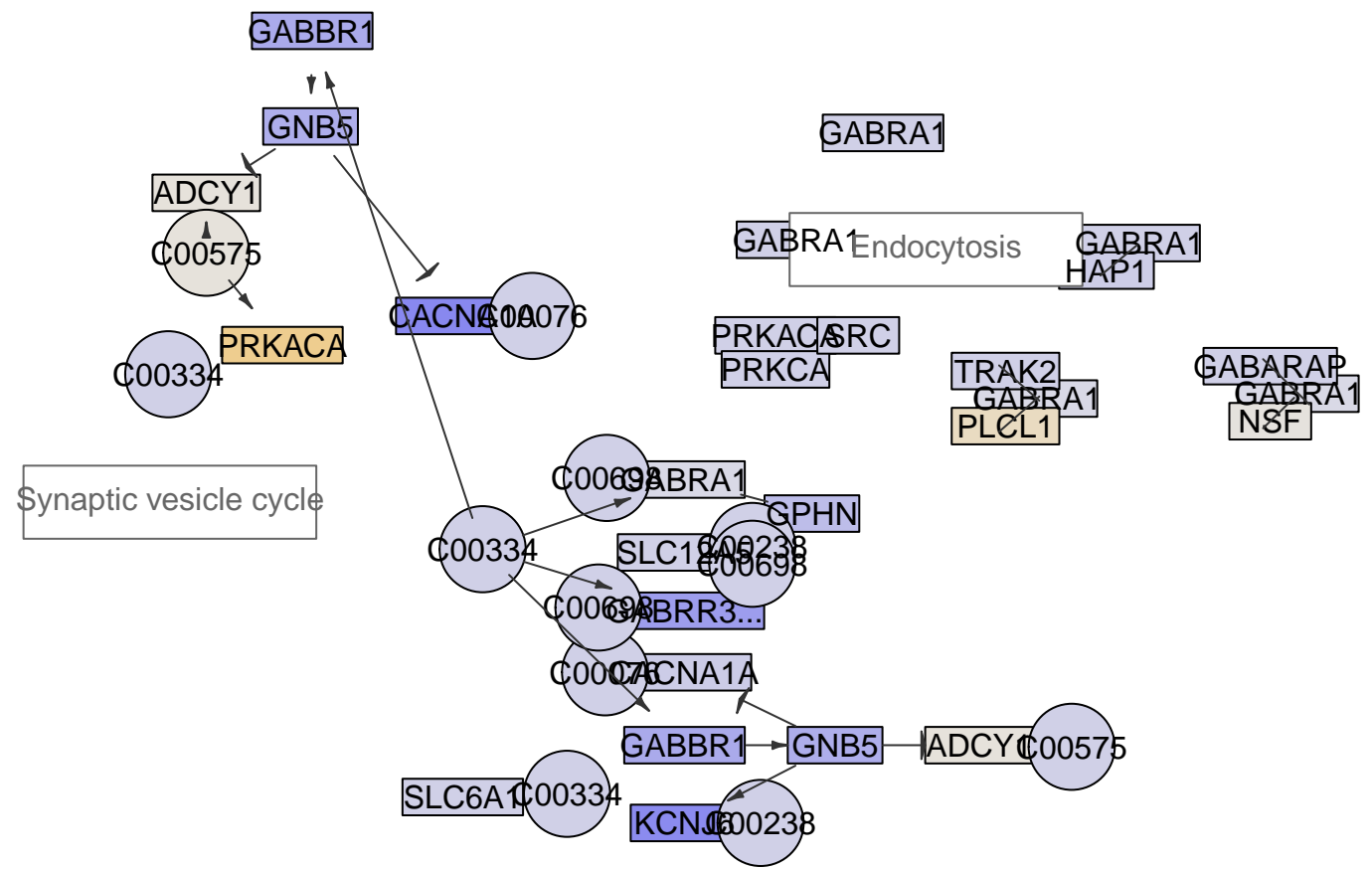
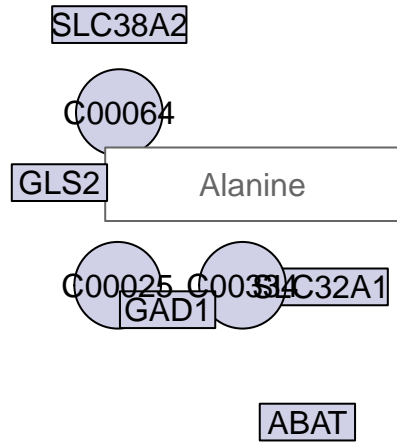

GABAergic synapse
MPI-210

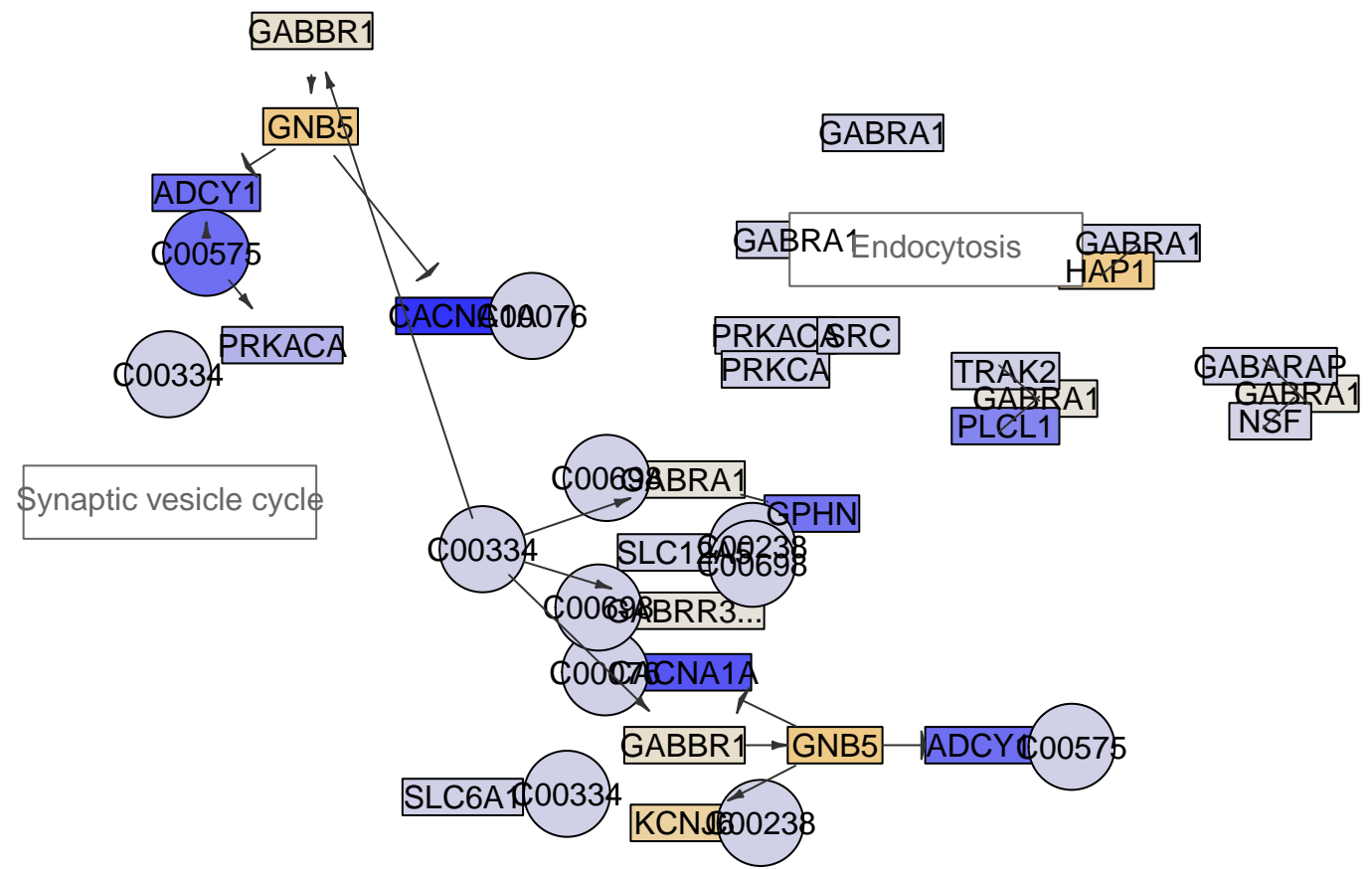
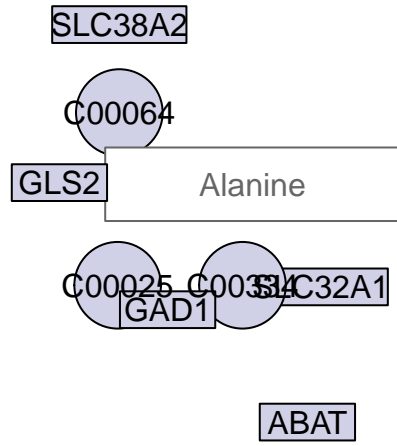

GABAergic synapse
MPI-212

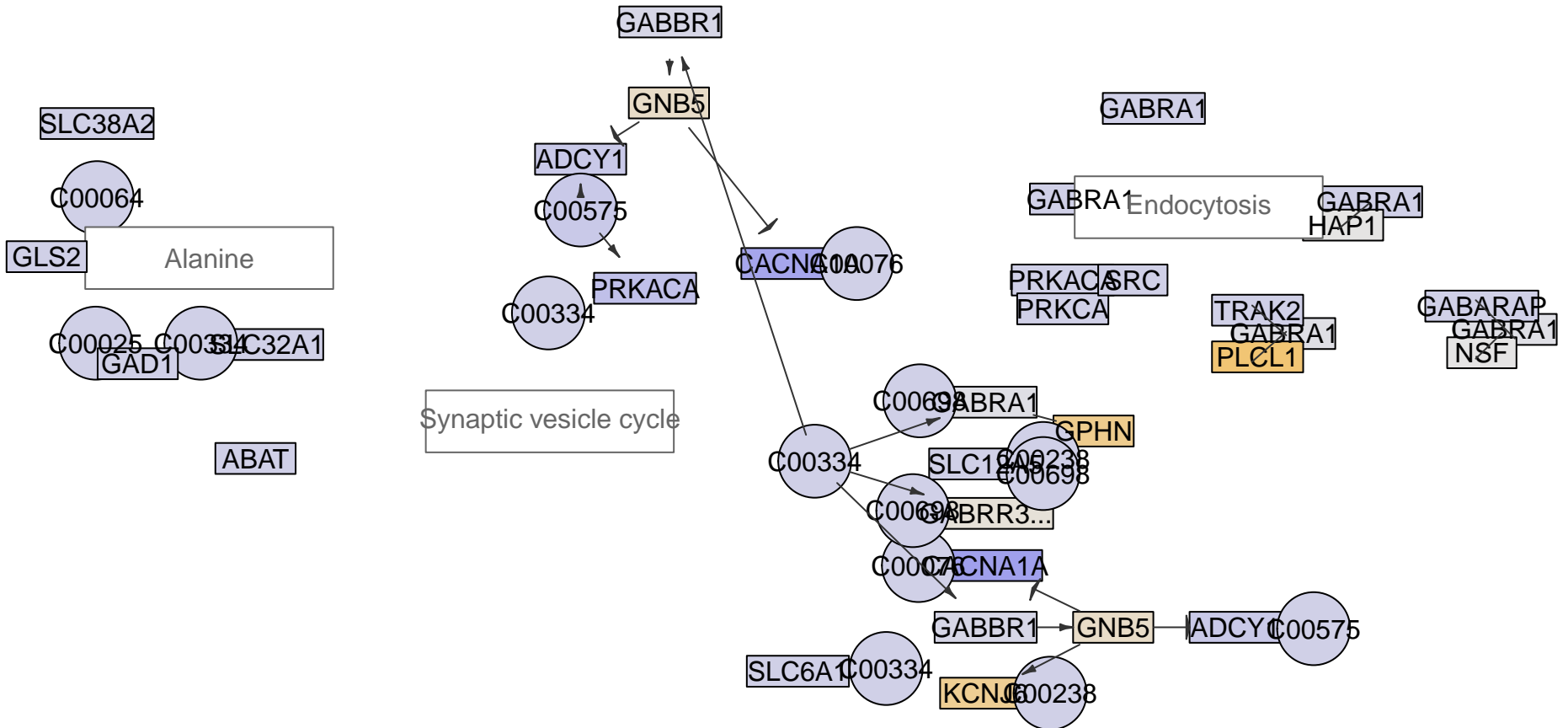
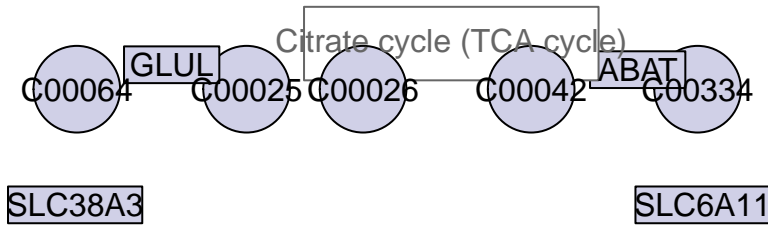

GABAergic synapse
MPI-213

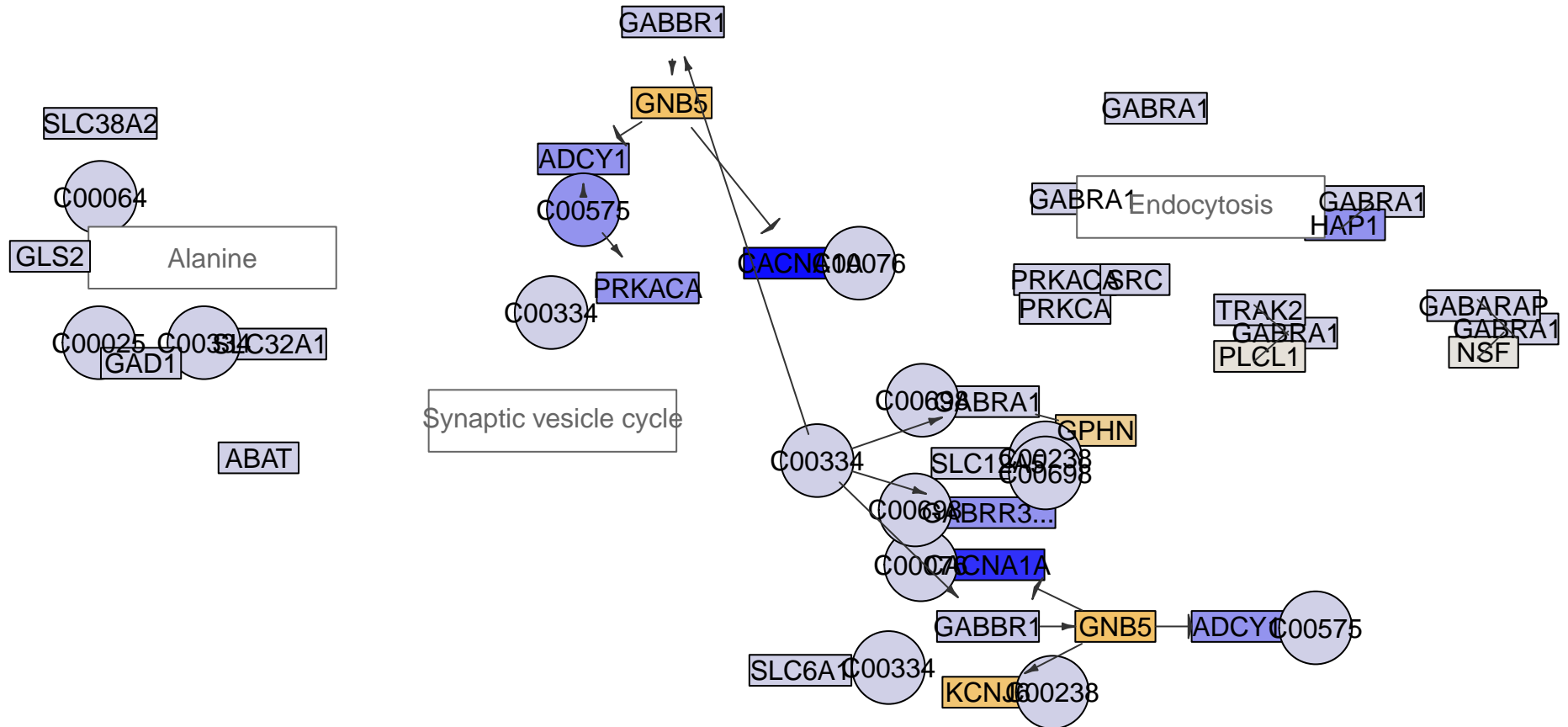
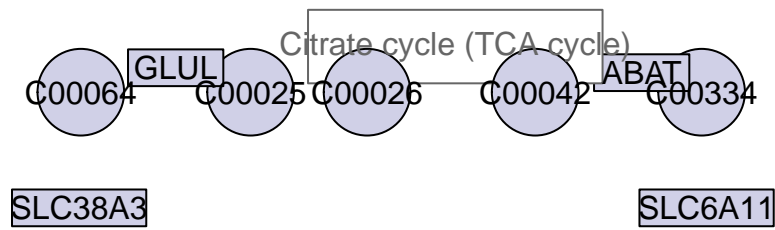

GABAergic synapse
MPI-215

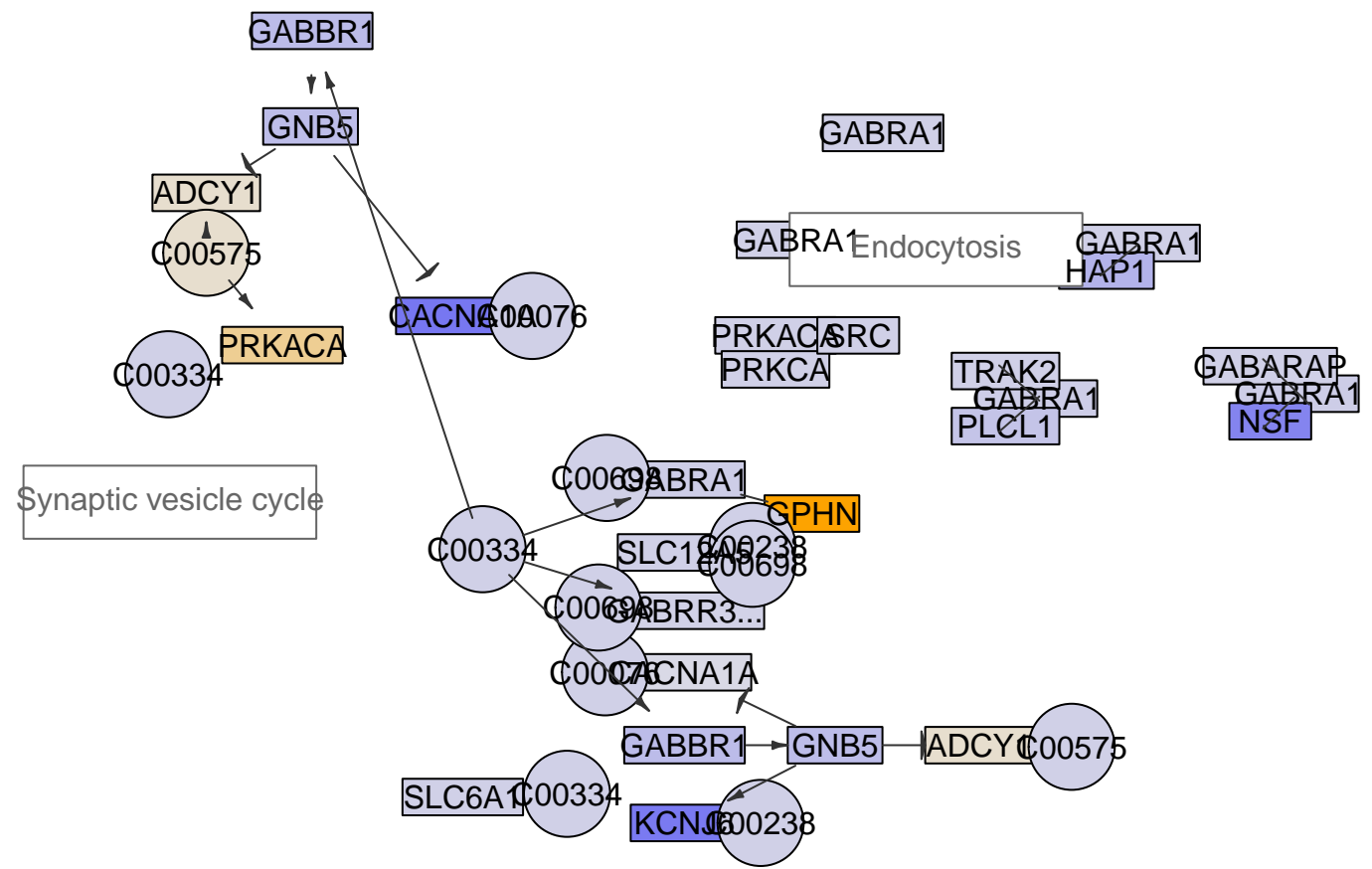
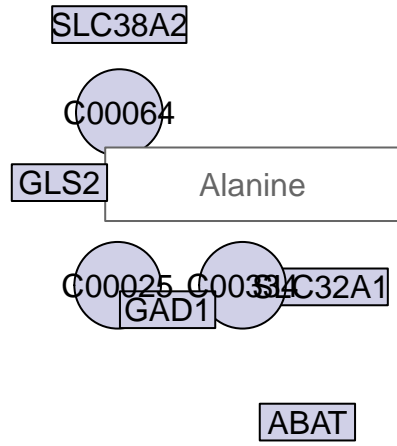

GABAergic synapse
MPI-219

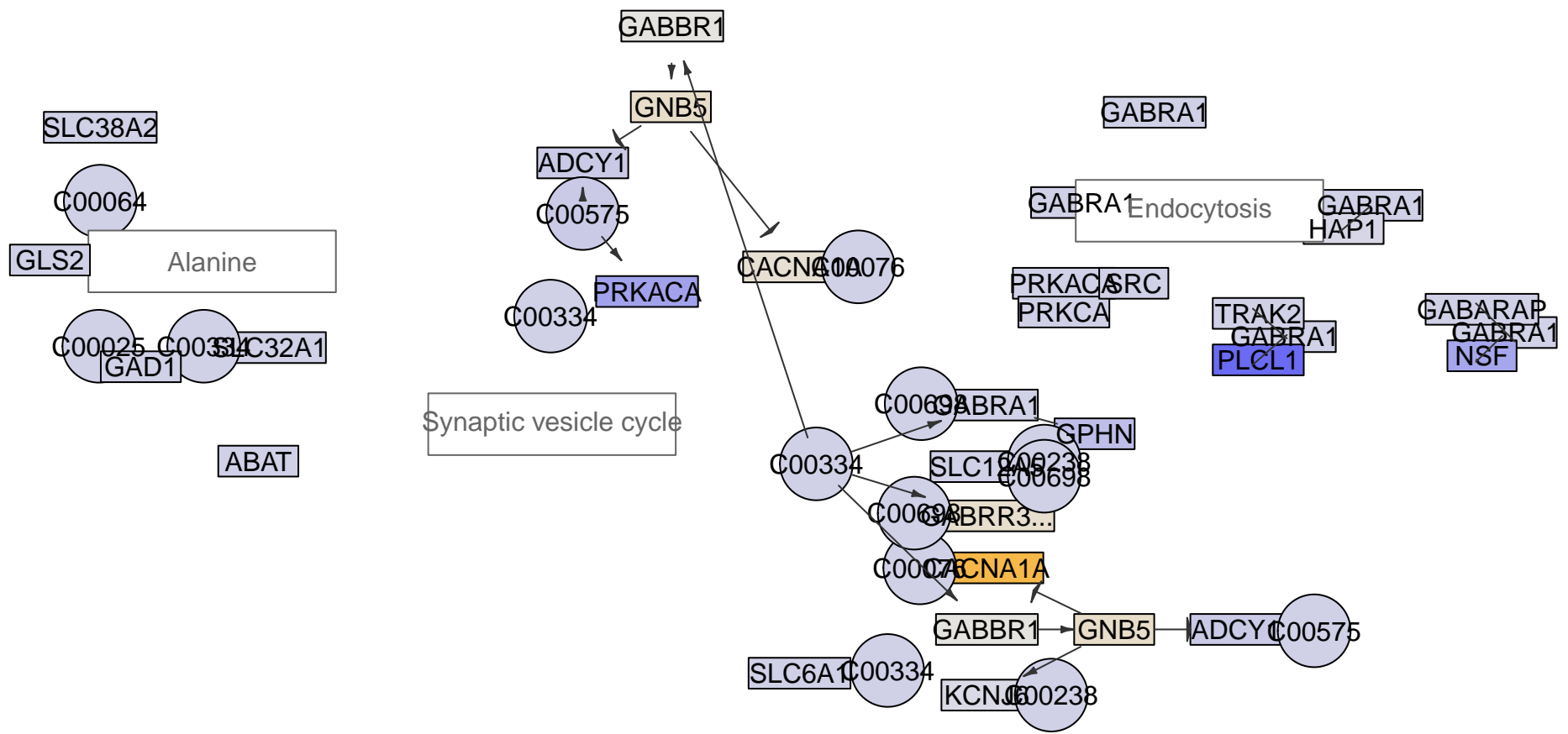

GABAergic synapse
MPI-221

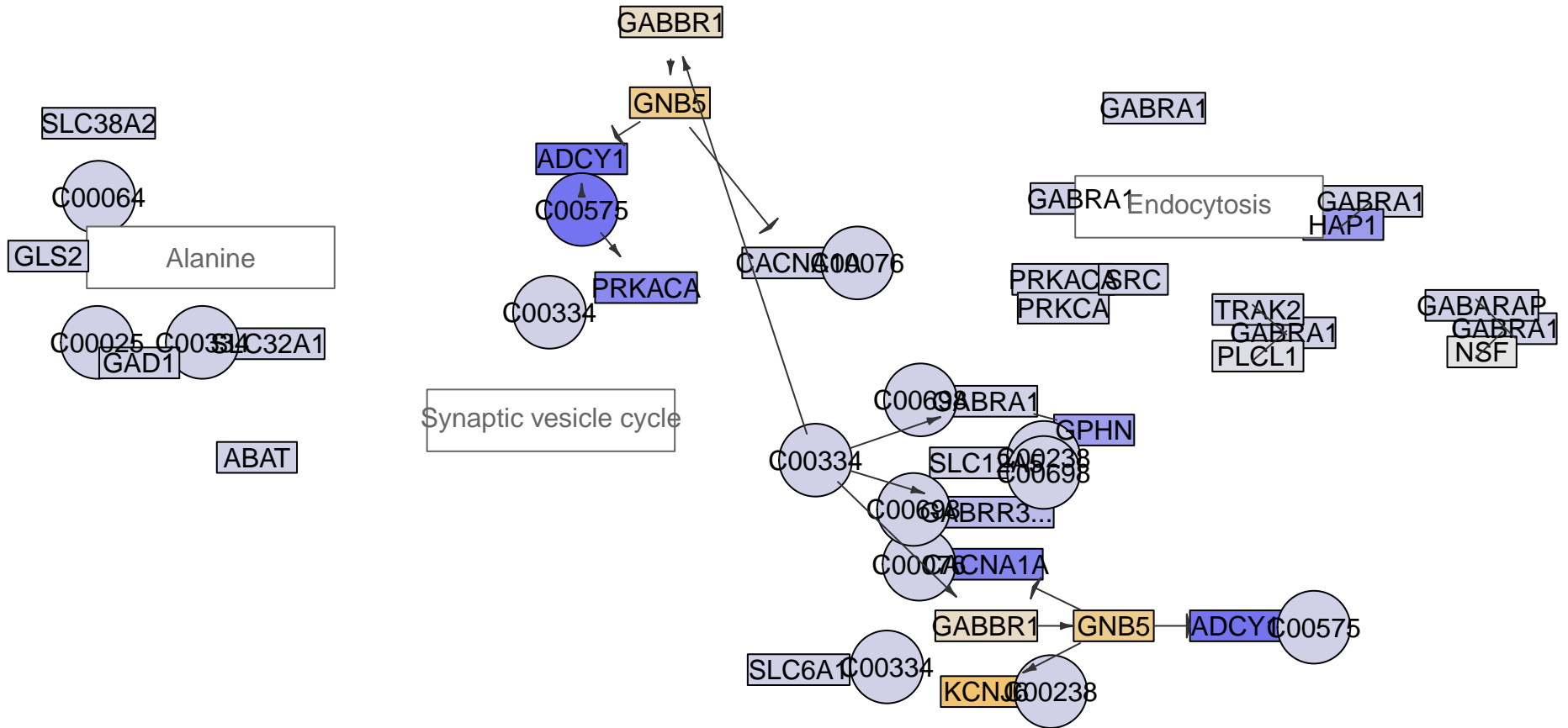
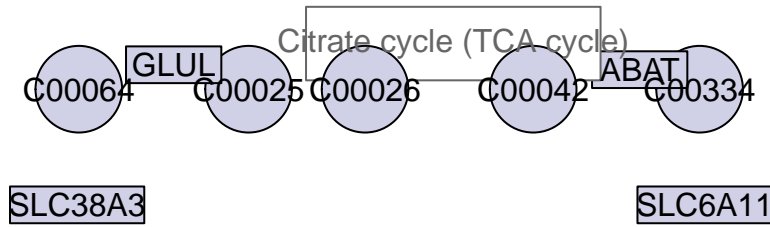

GABAergic synapse
MPI-223a

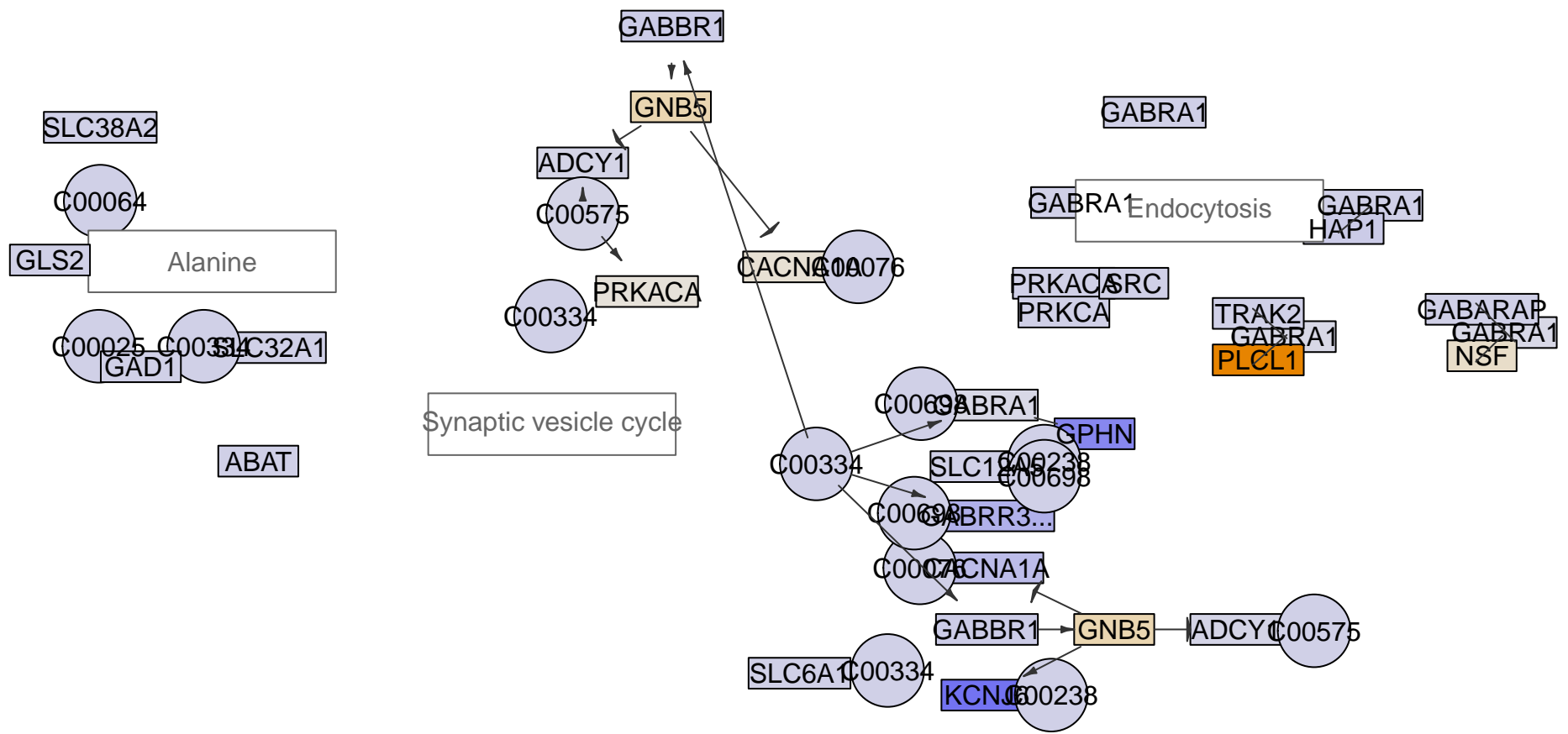

GABAergic synapse
MPI-224

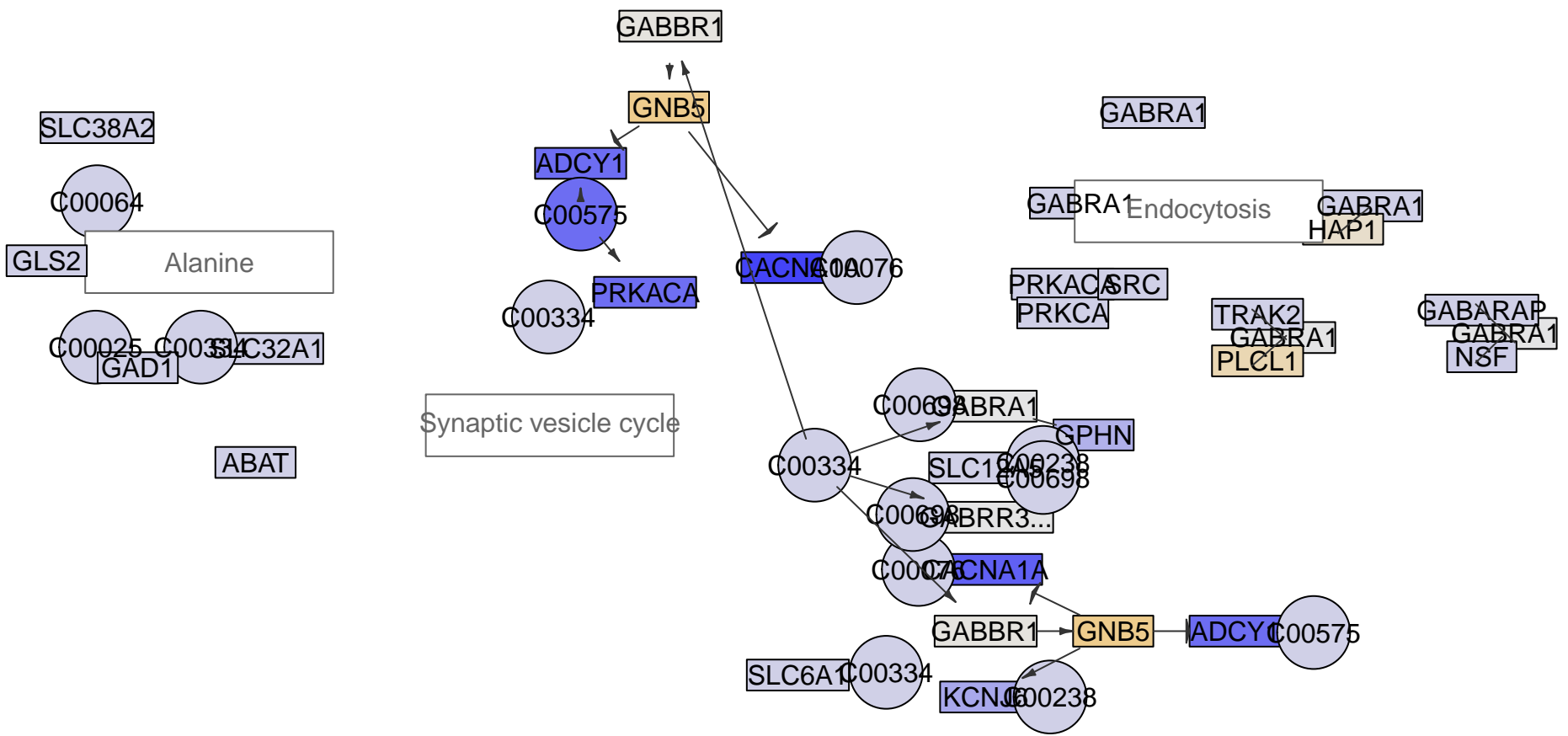

GABAergic synapse
MPI-226

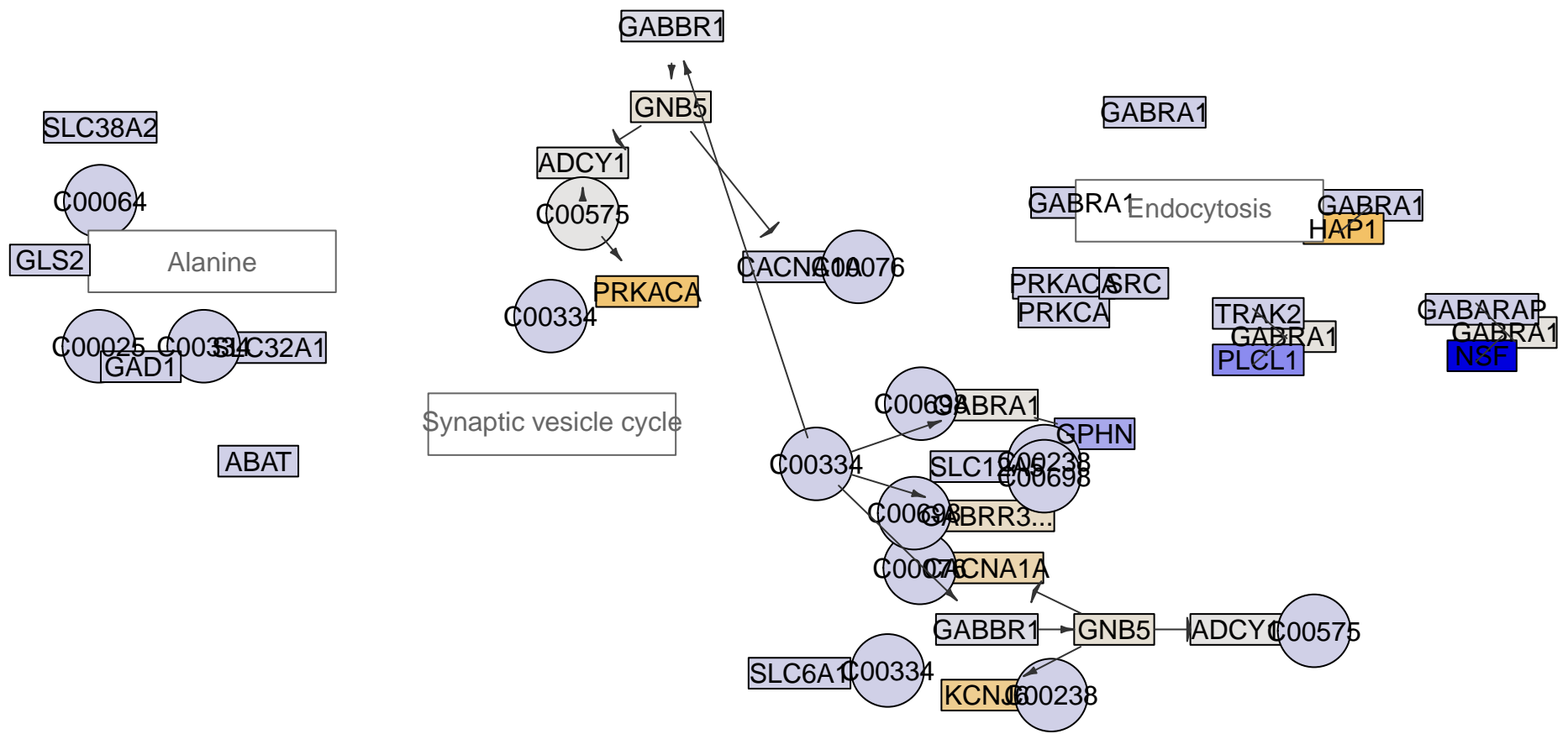

GABAergic synapse
MPI-227

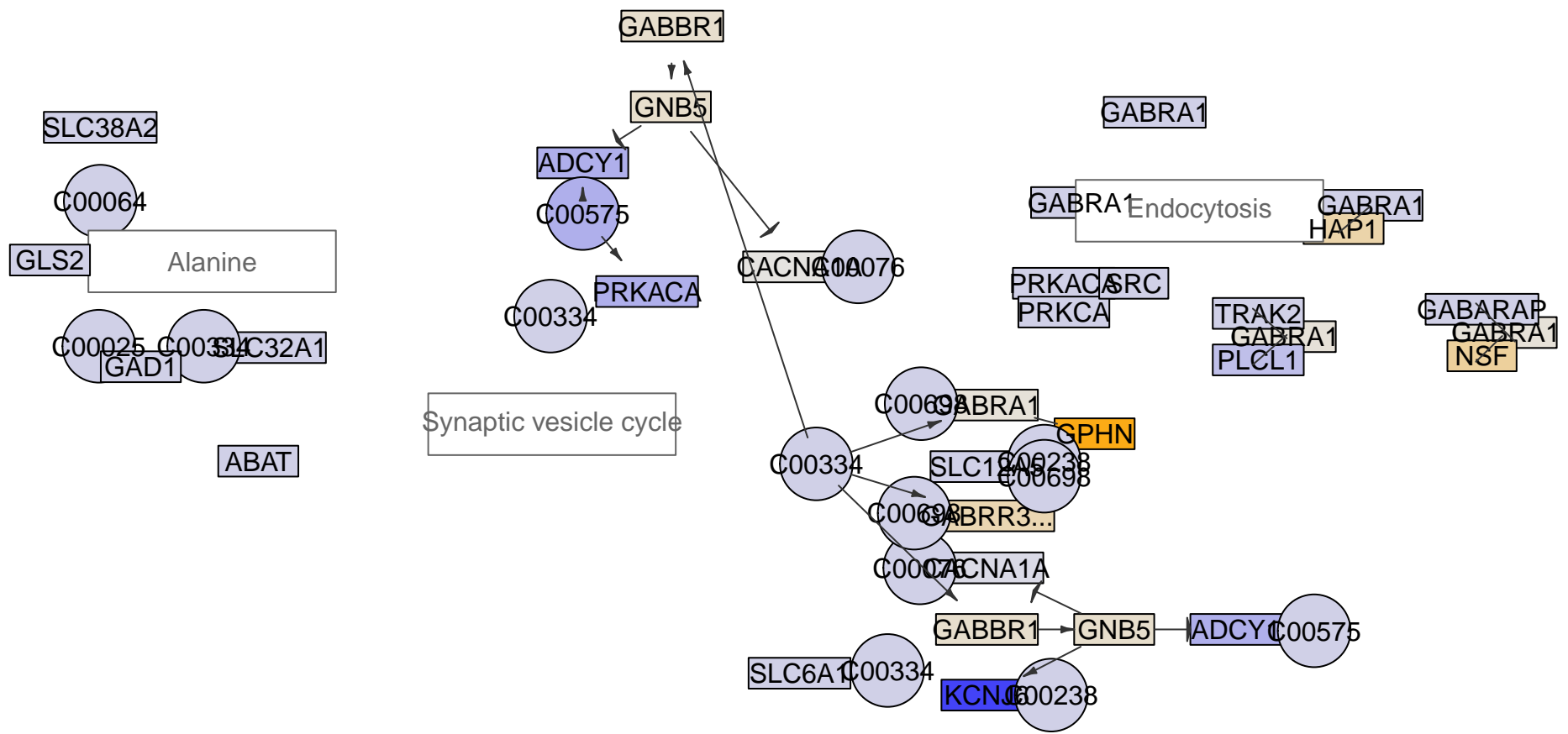

GABAergic synapse
MPI-228

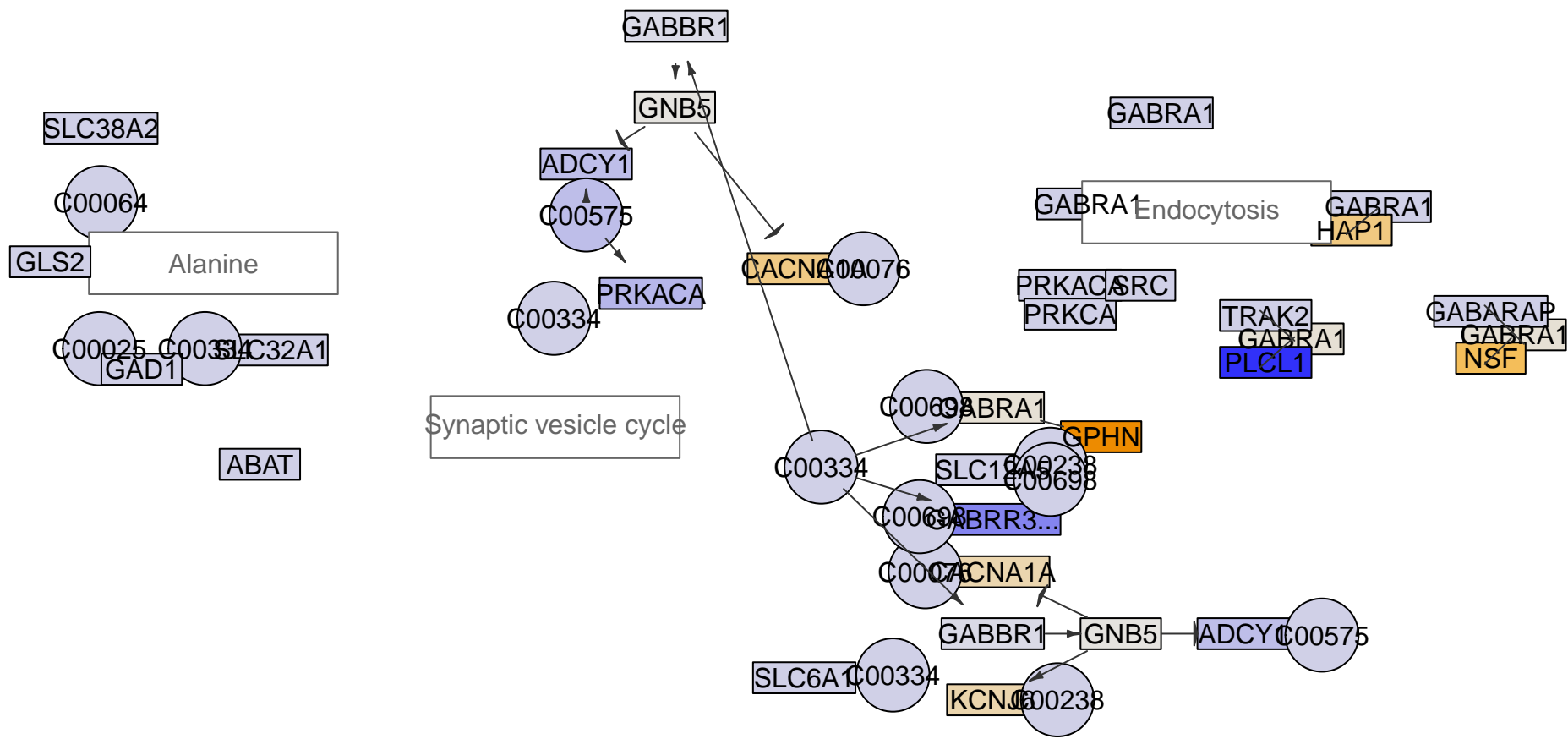

GABAergic synapse
MPI-229

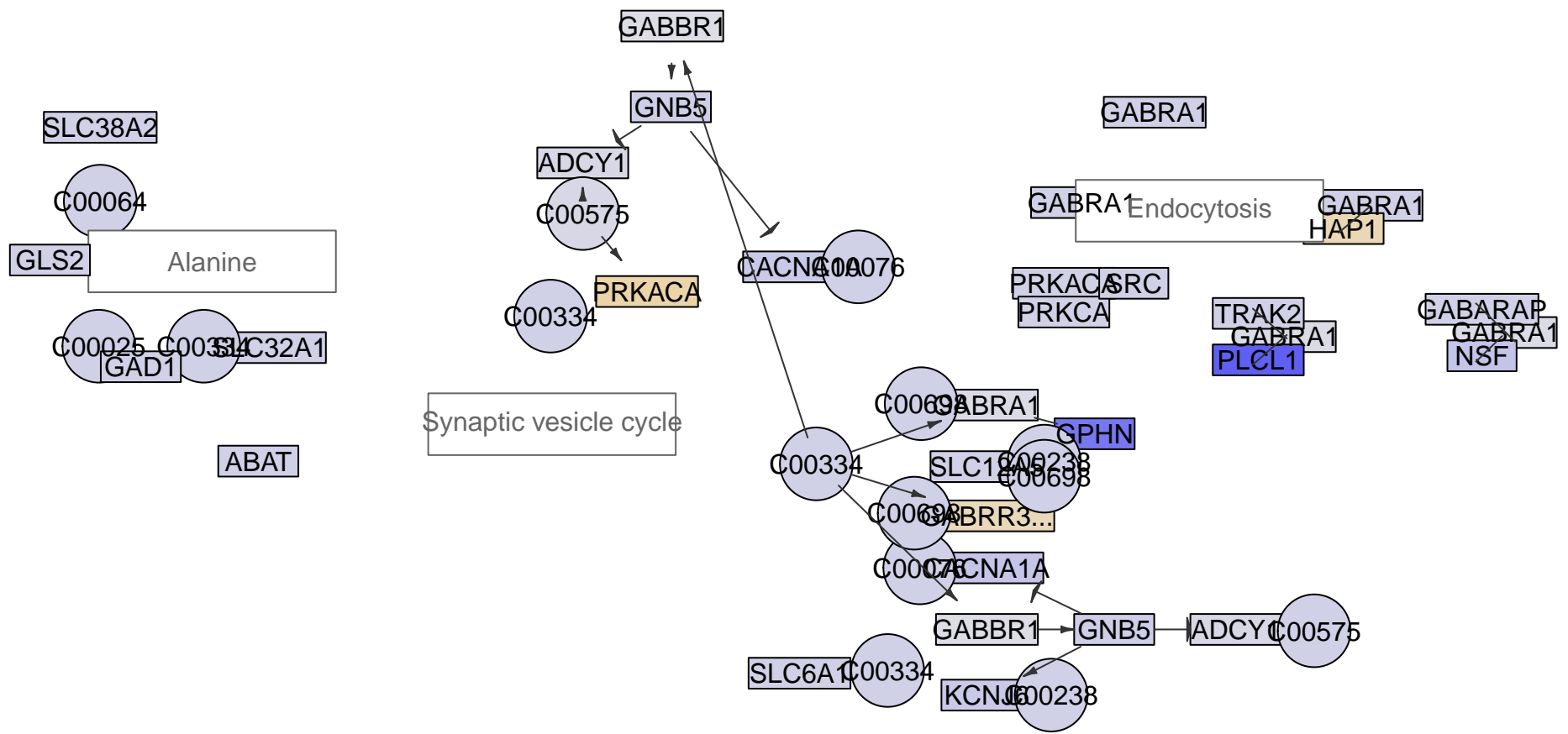

GABAergic synapse
MPI-230

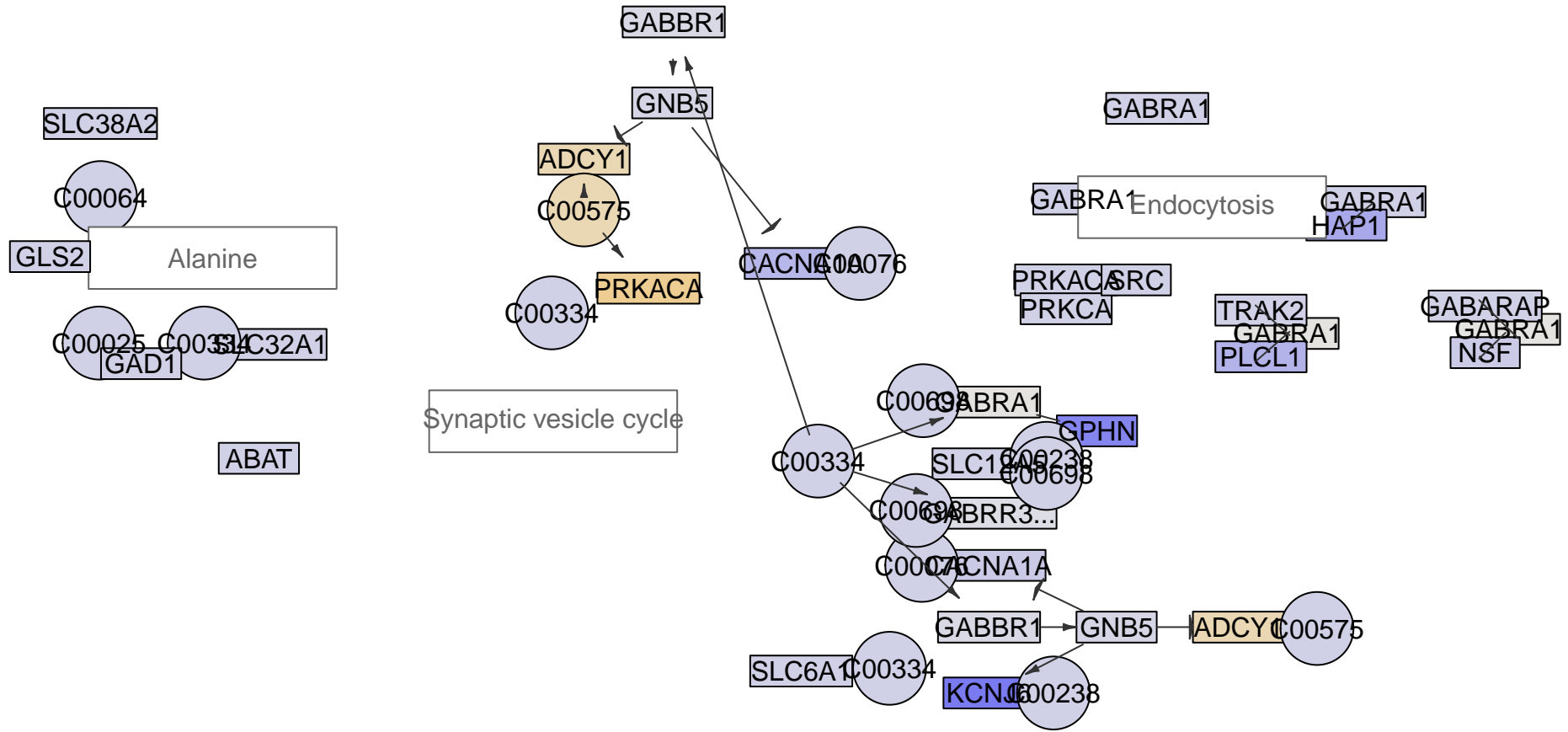

GABAergic synapse
MPI-231

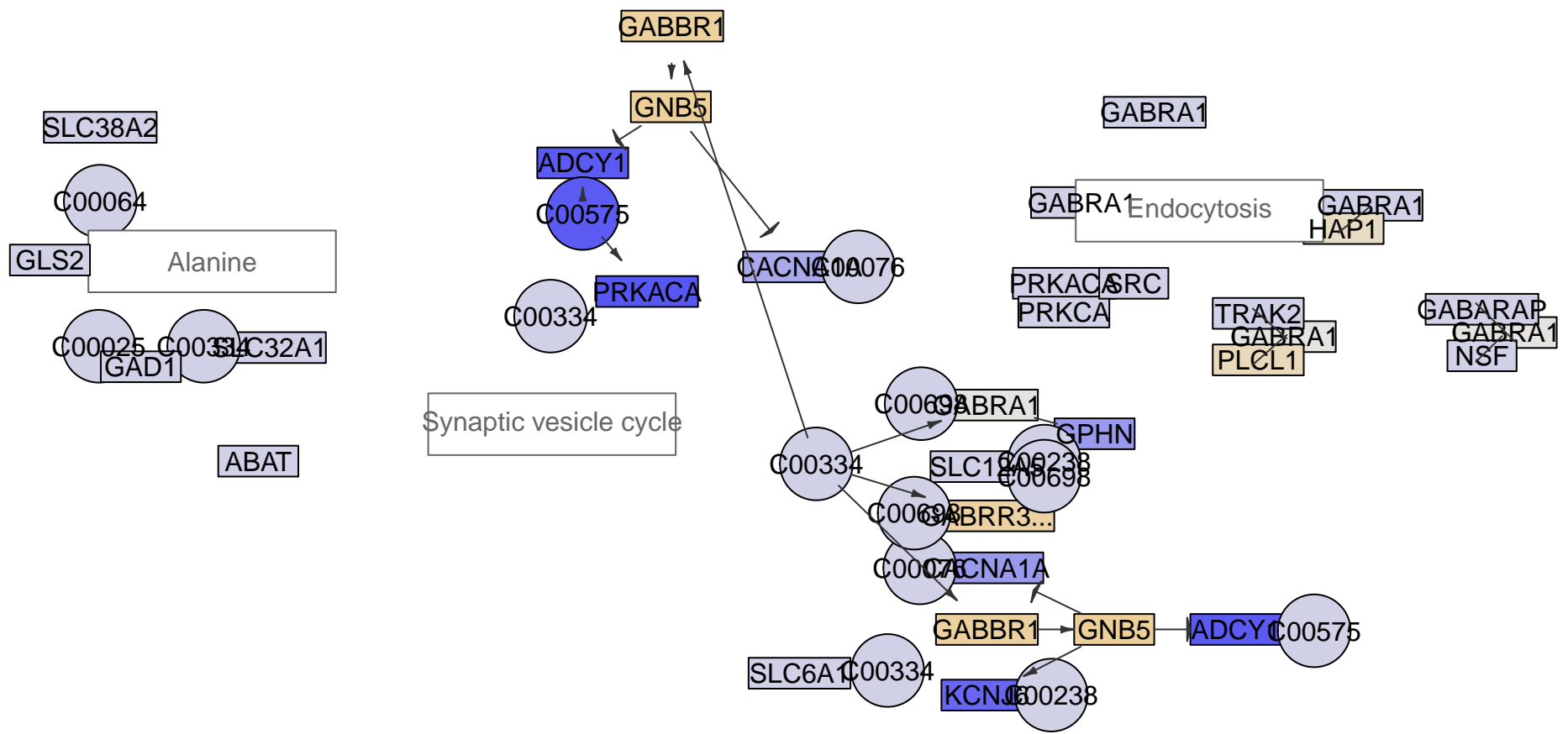

GABAergic synapse
MPI-232

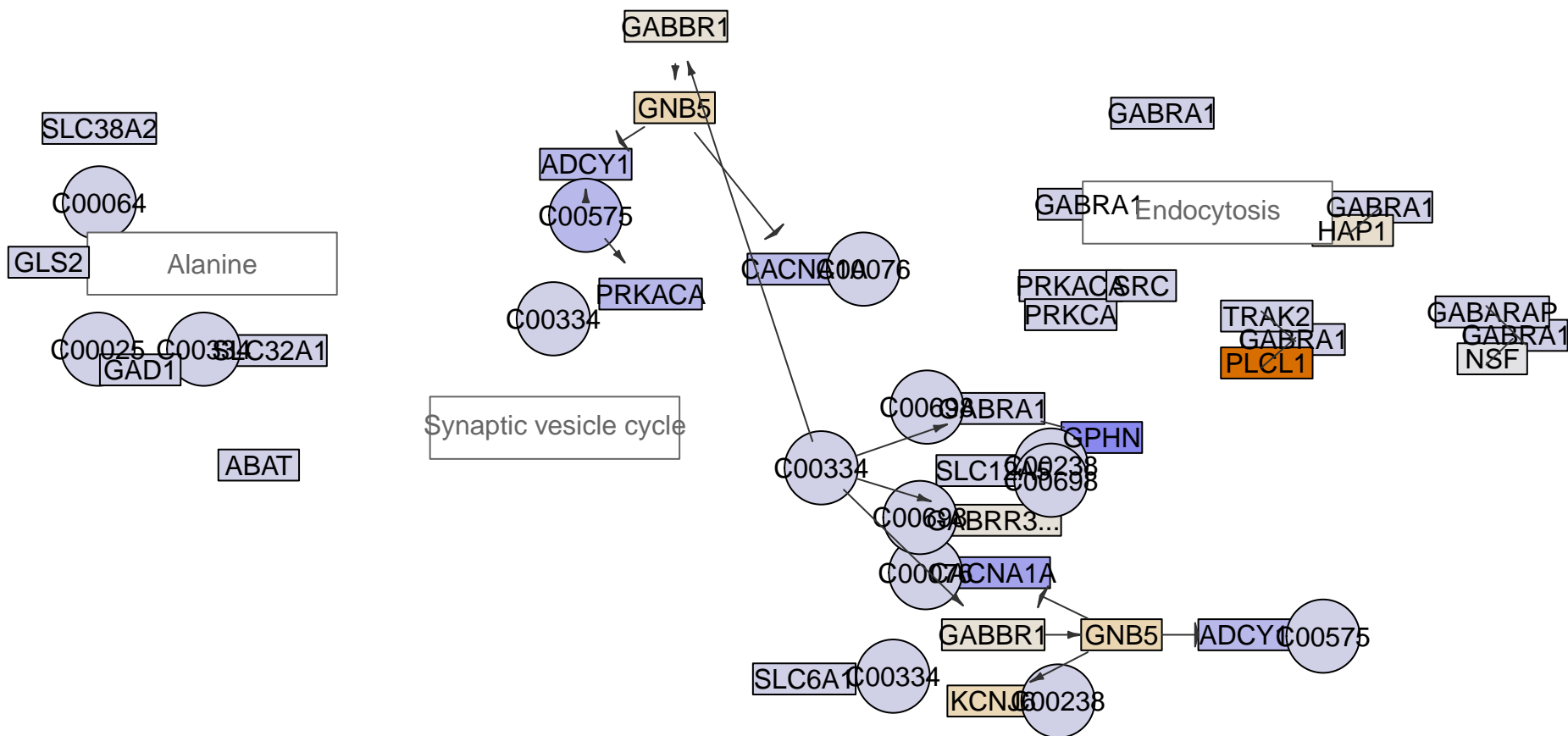
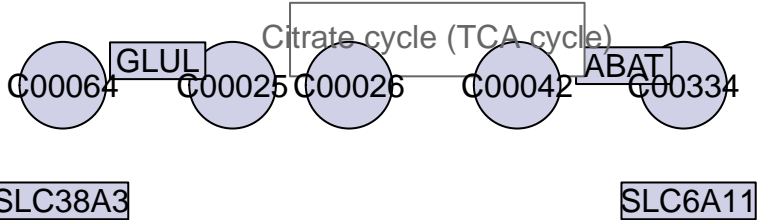

GABAergic synapse
MPI-233

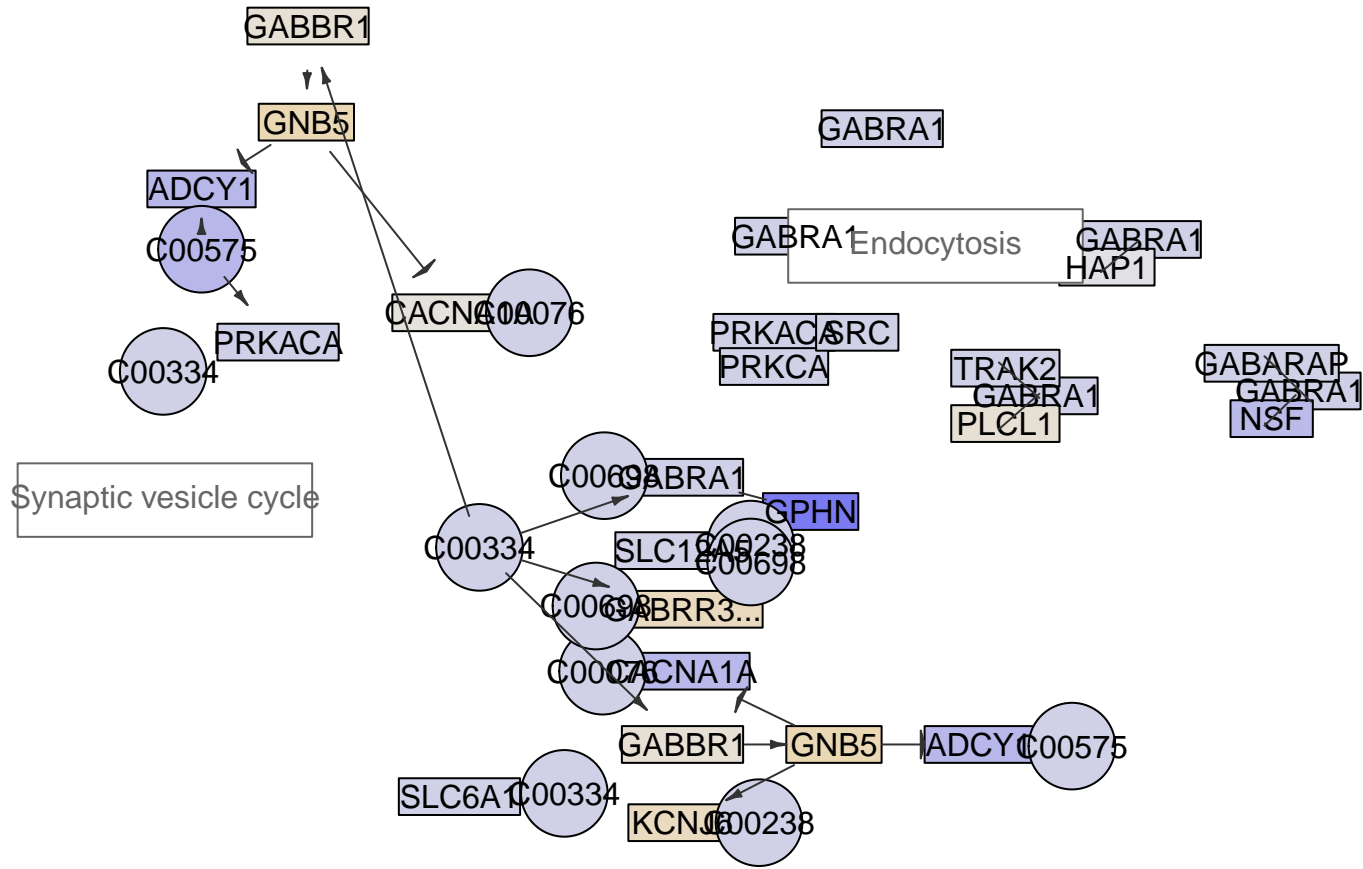
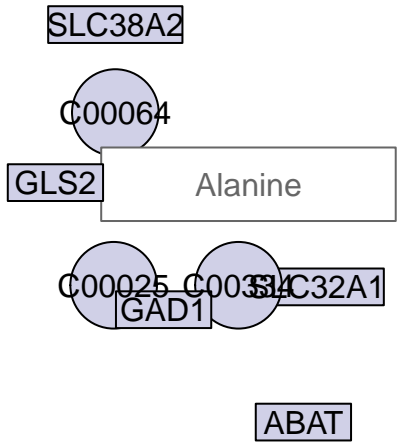

GABAergic synapse
MPI-234

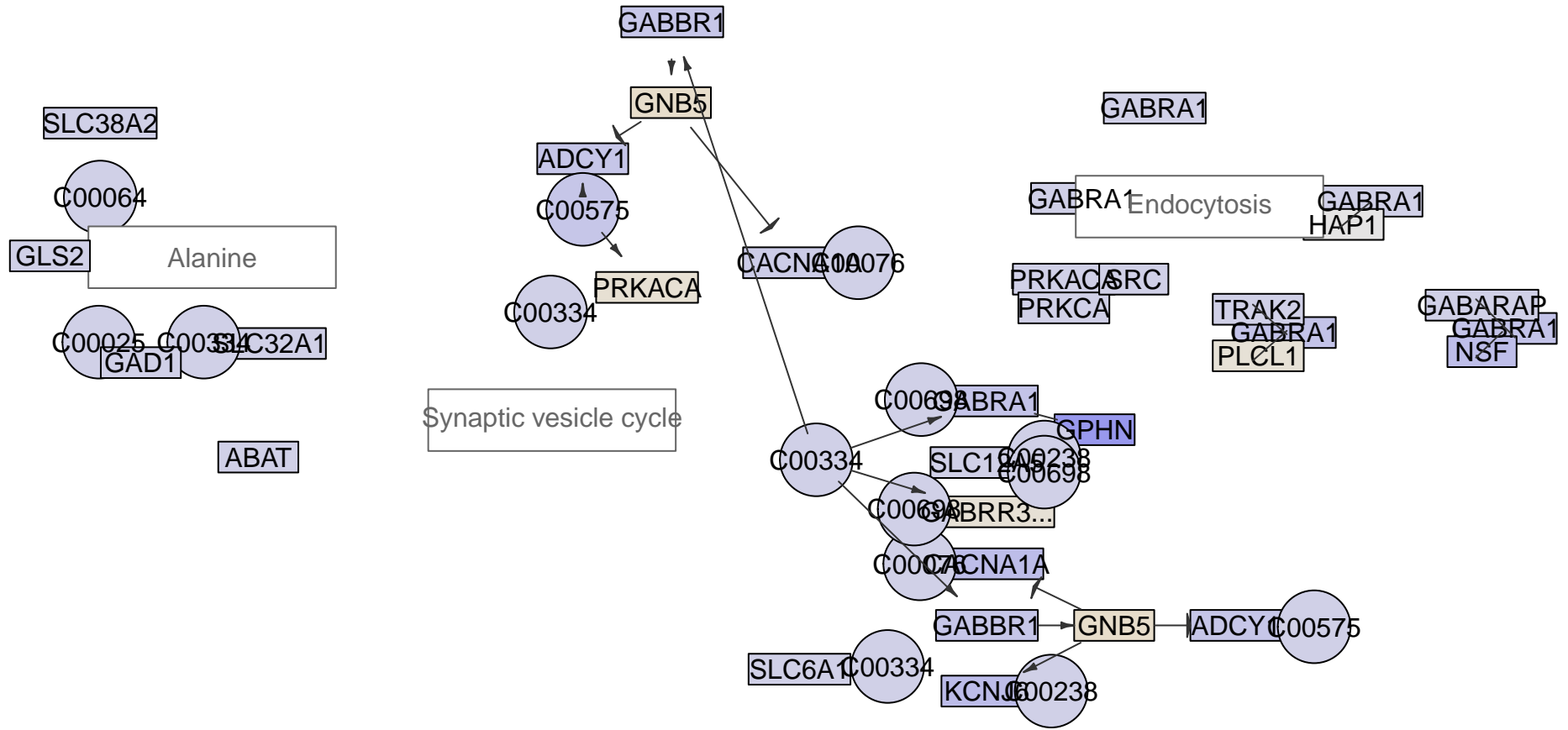

GABAergic synapse
MPI-235

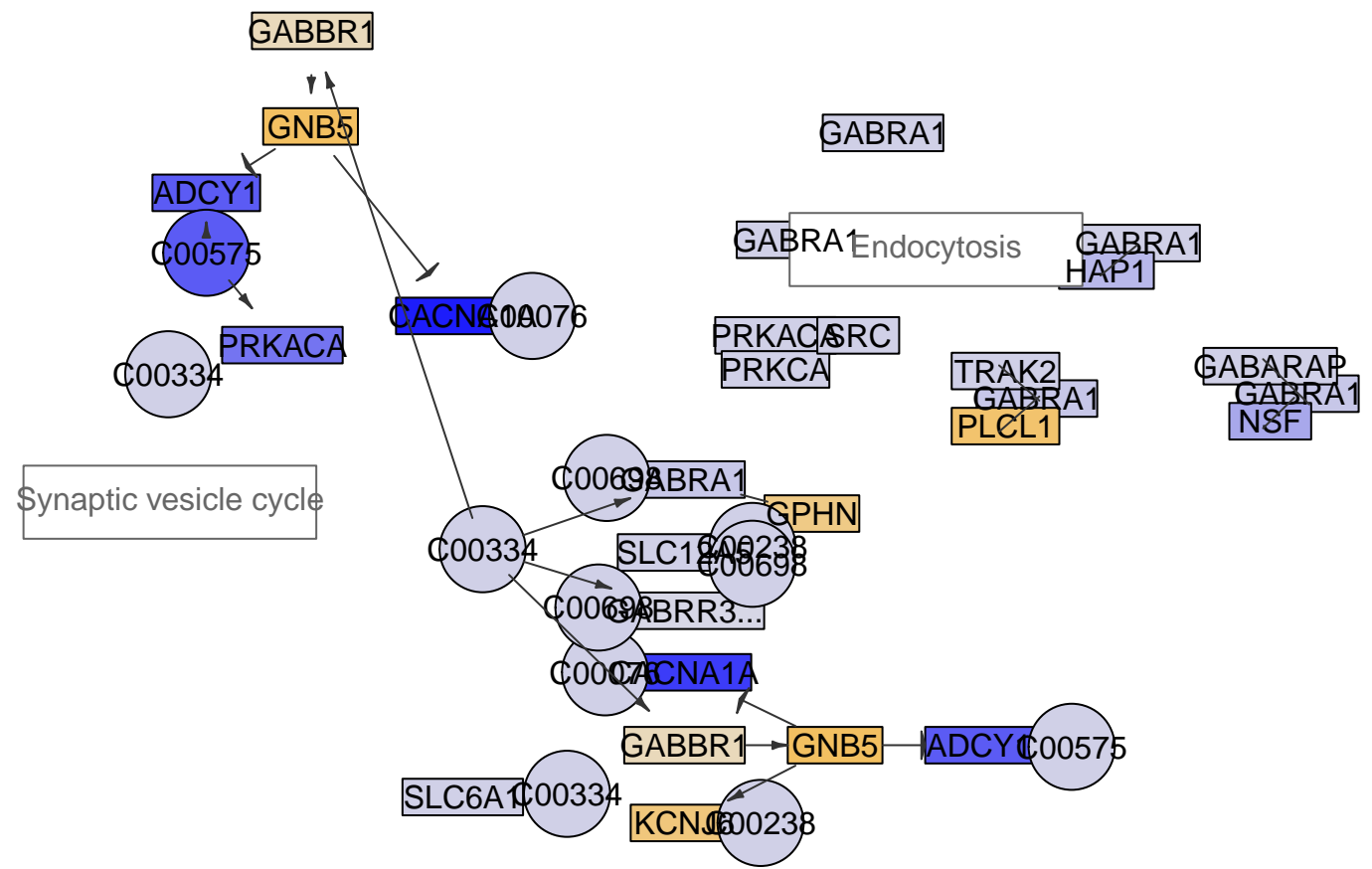
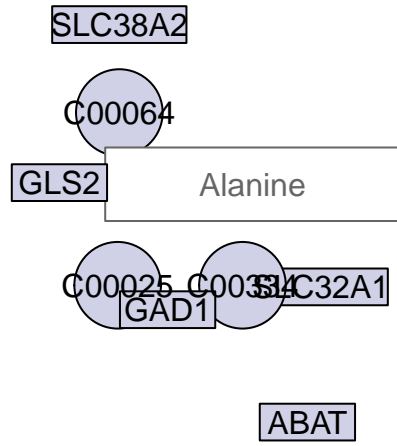

GABAergic synapse
MPI-236

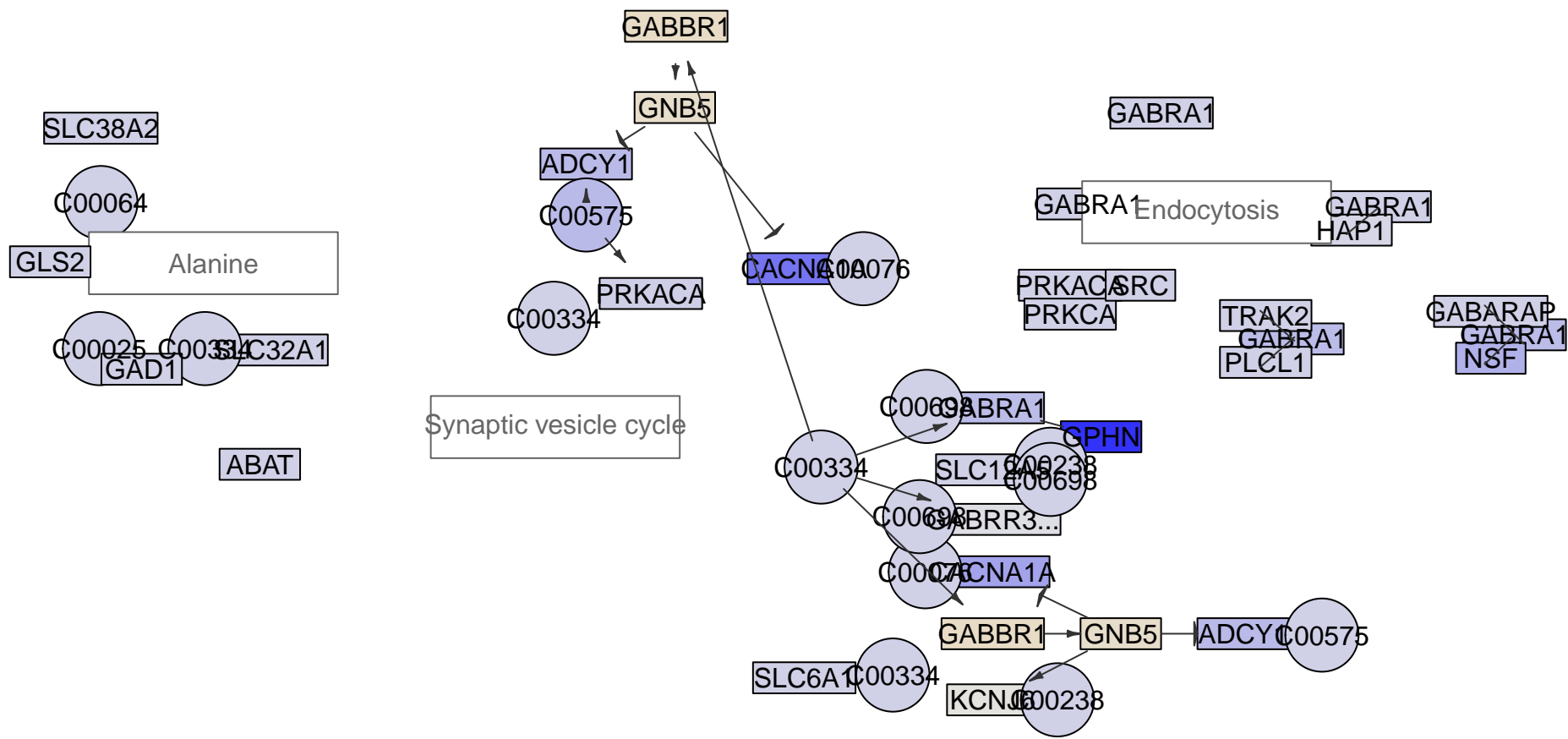

GABAergic synapse
MPI-237

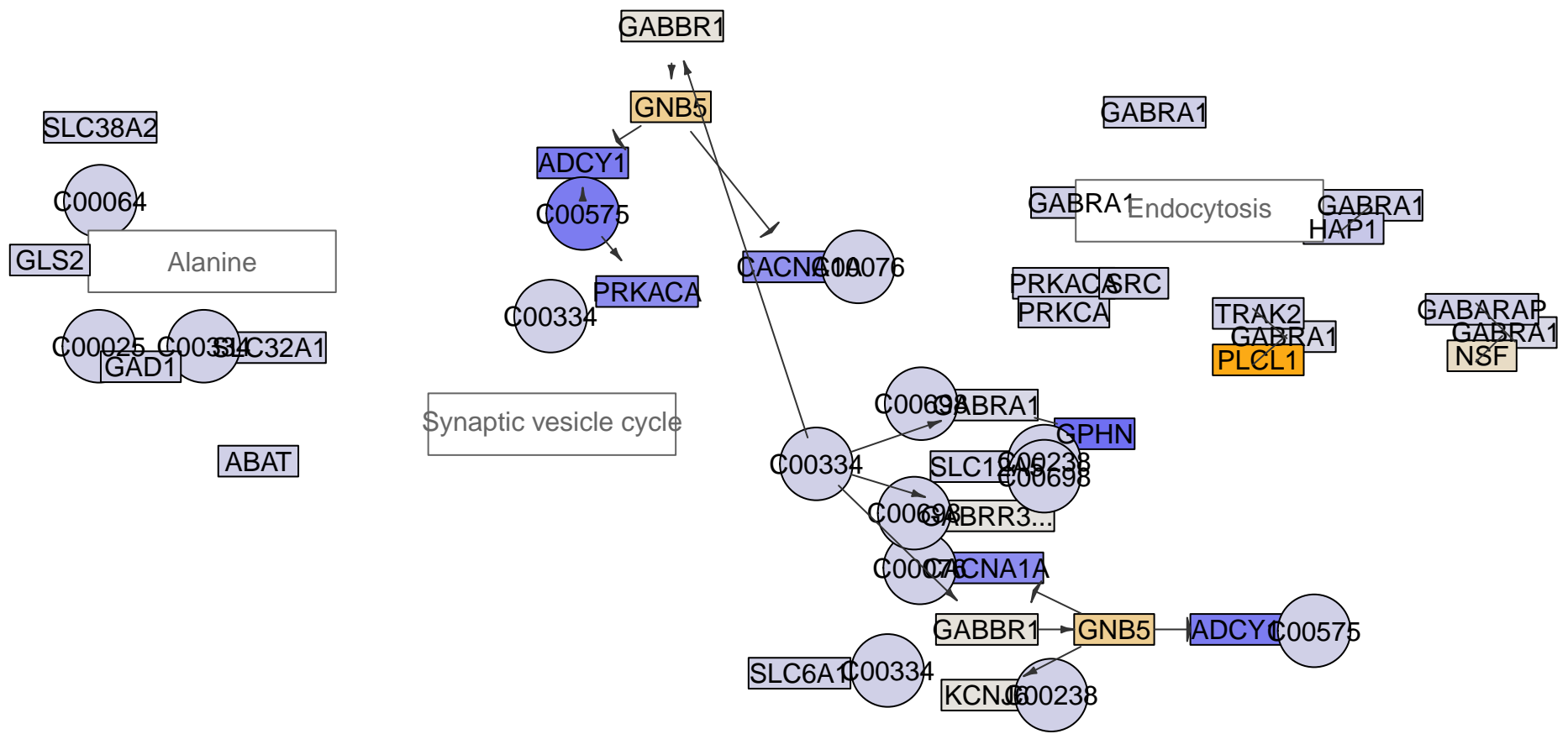

GABAergic synapse
MPI-239

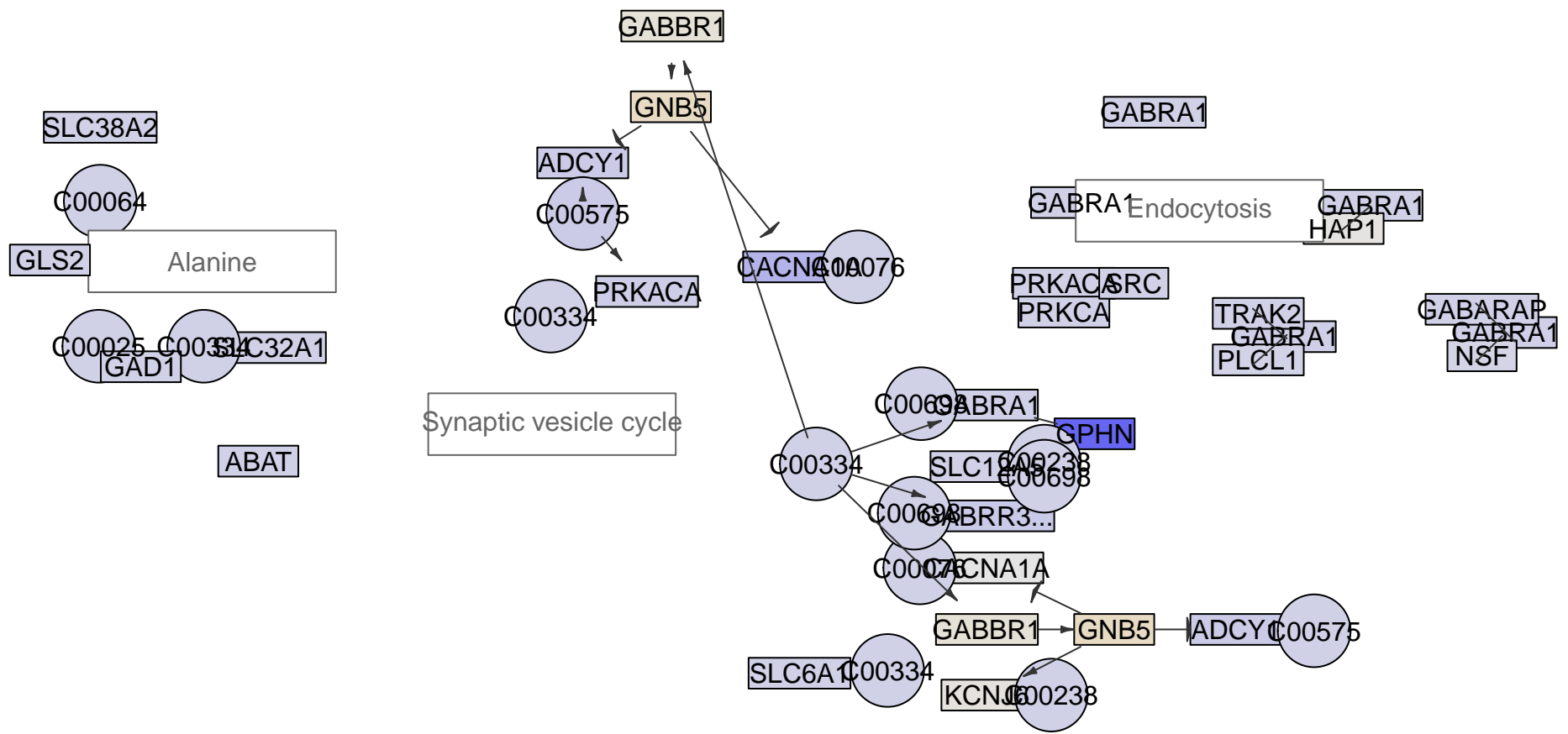

GABAergic synapse
MPI-241

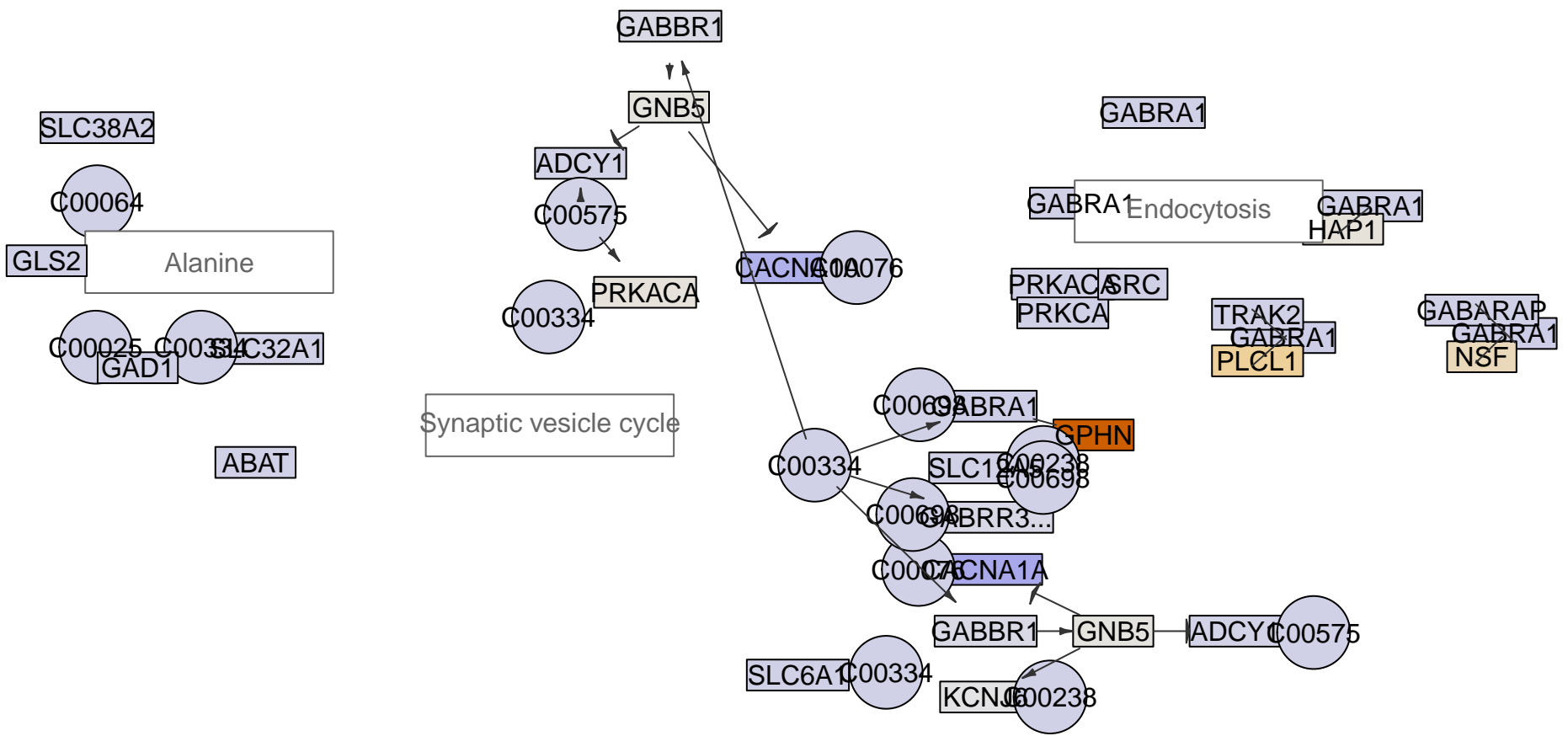

GABAergic synapse
MPI-243

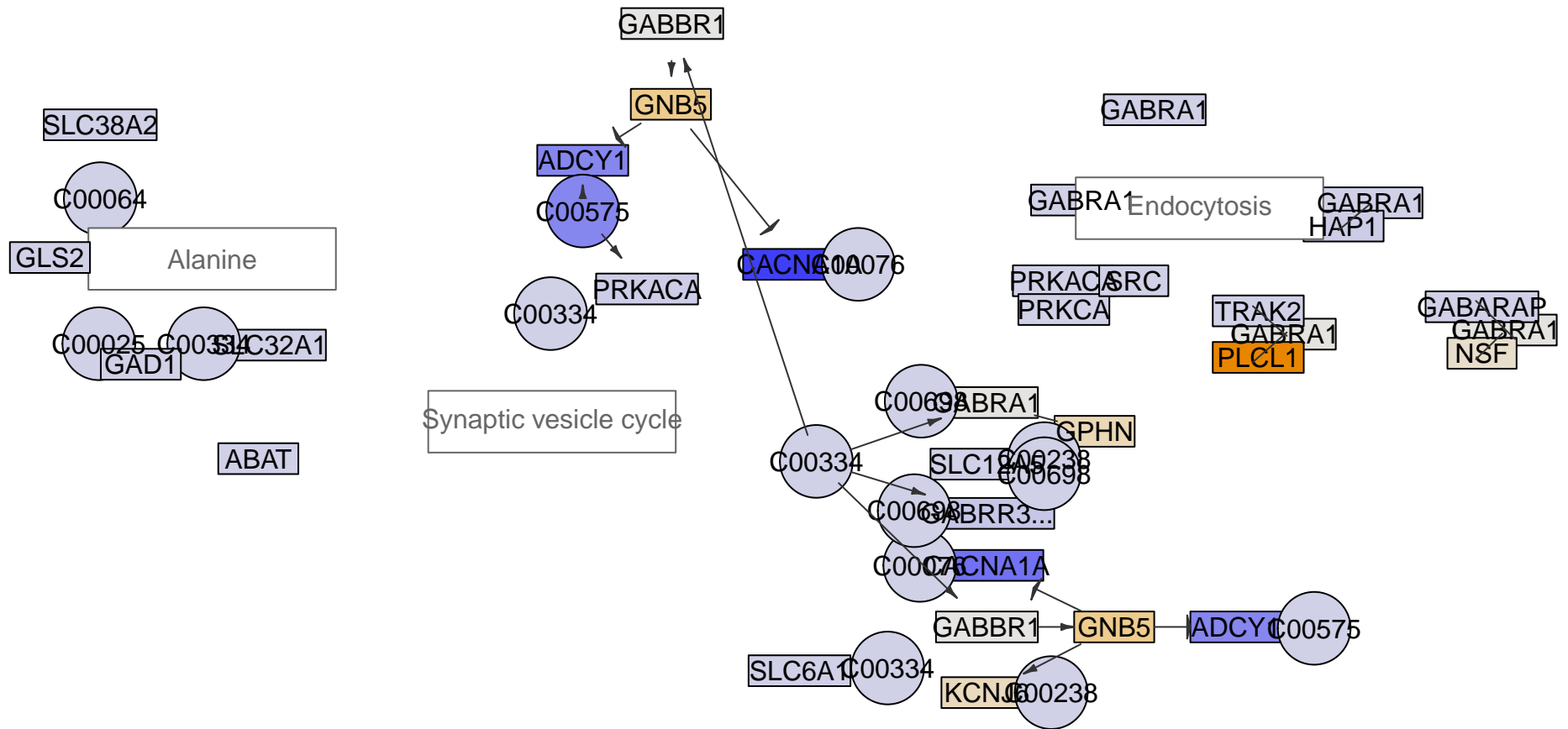
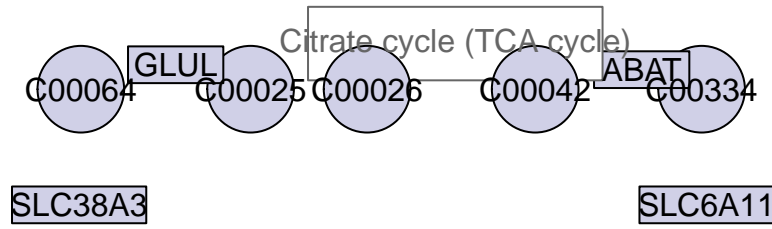

GABAergic synapse
MPI-244

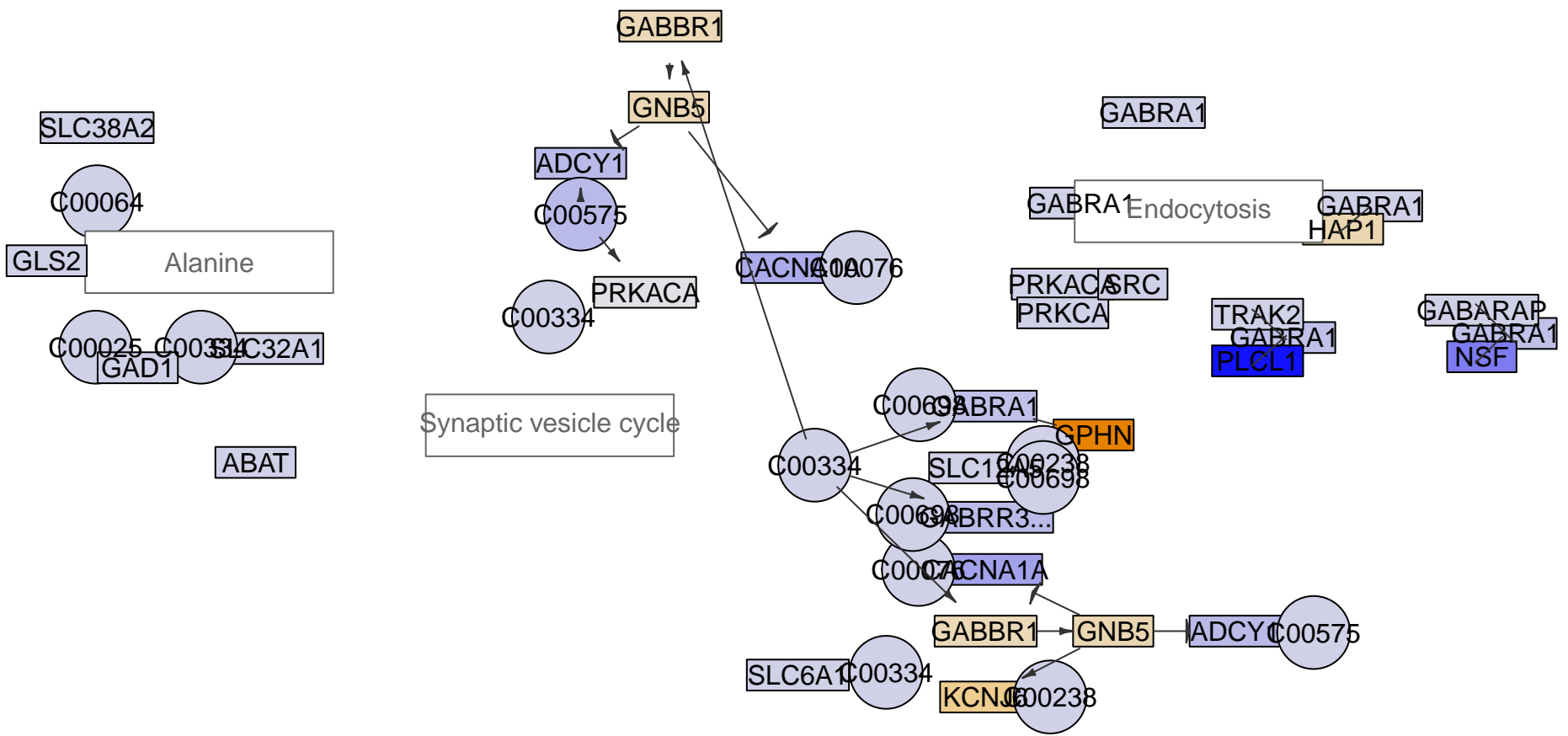

GABAergic synapse
MPI-246

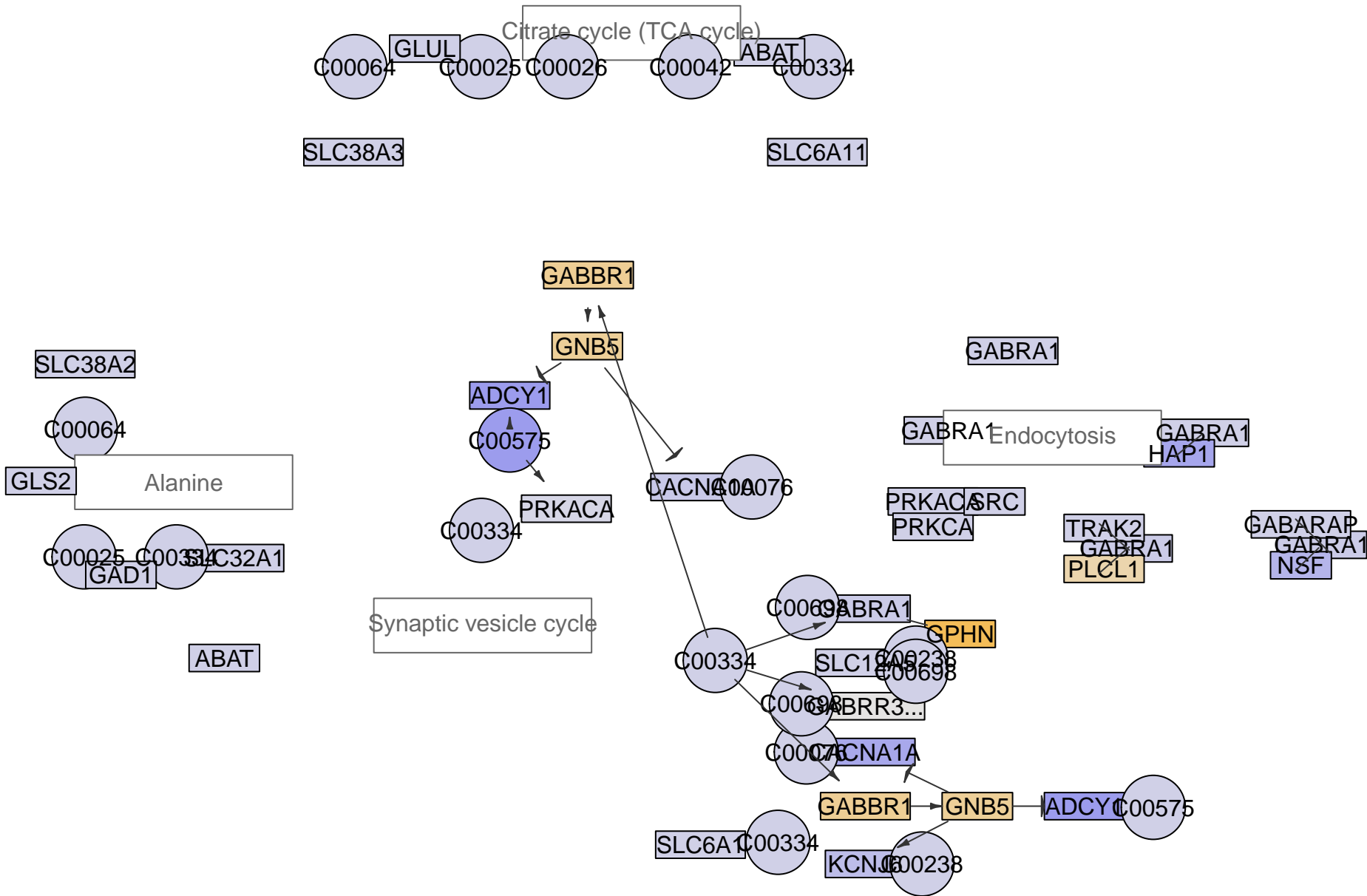

GABAergic synapse
MPI-247

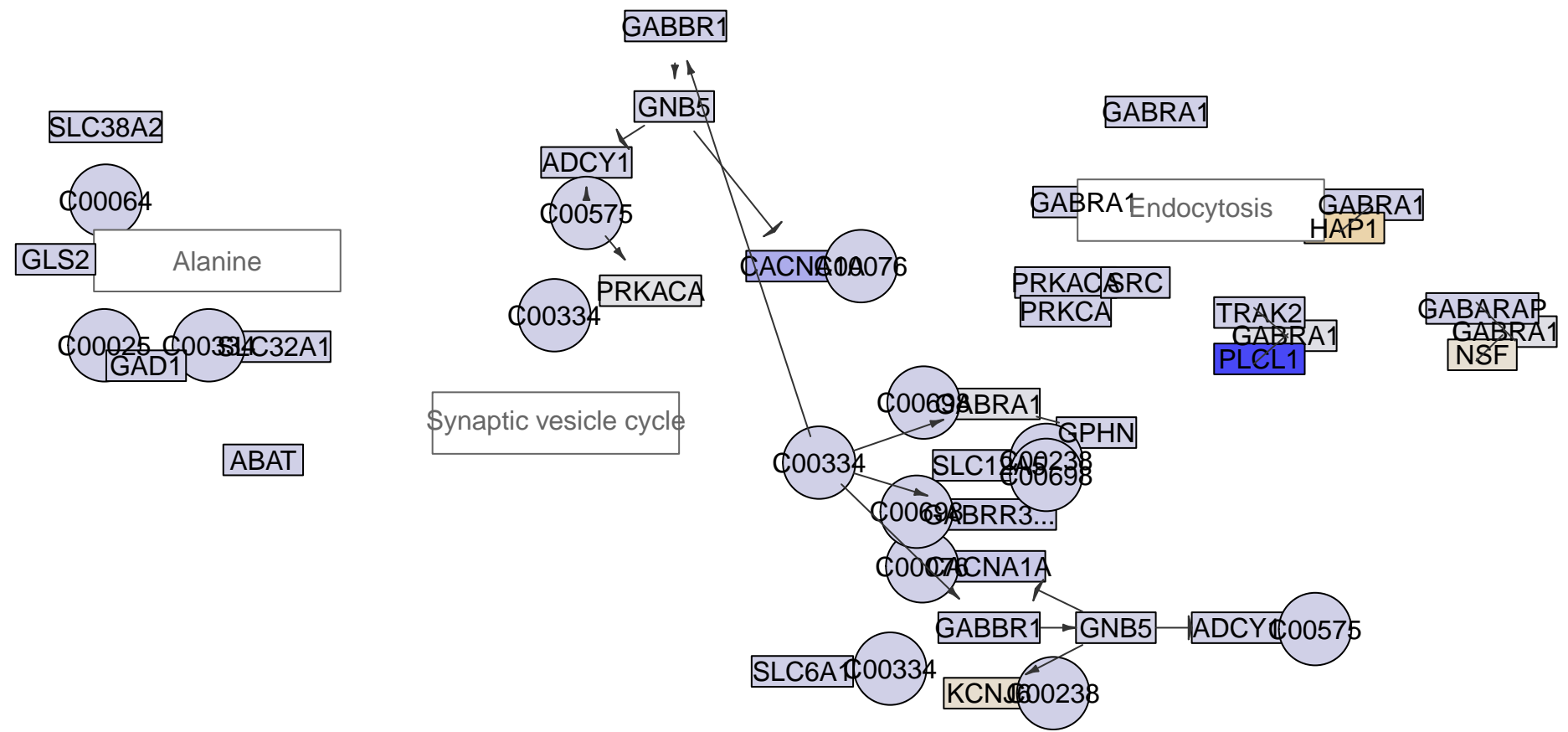

GABAergic synapse
MPI-251

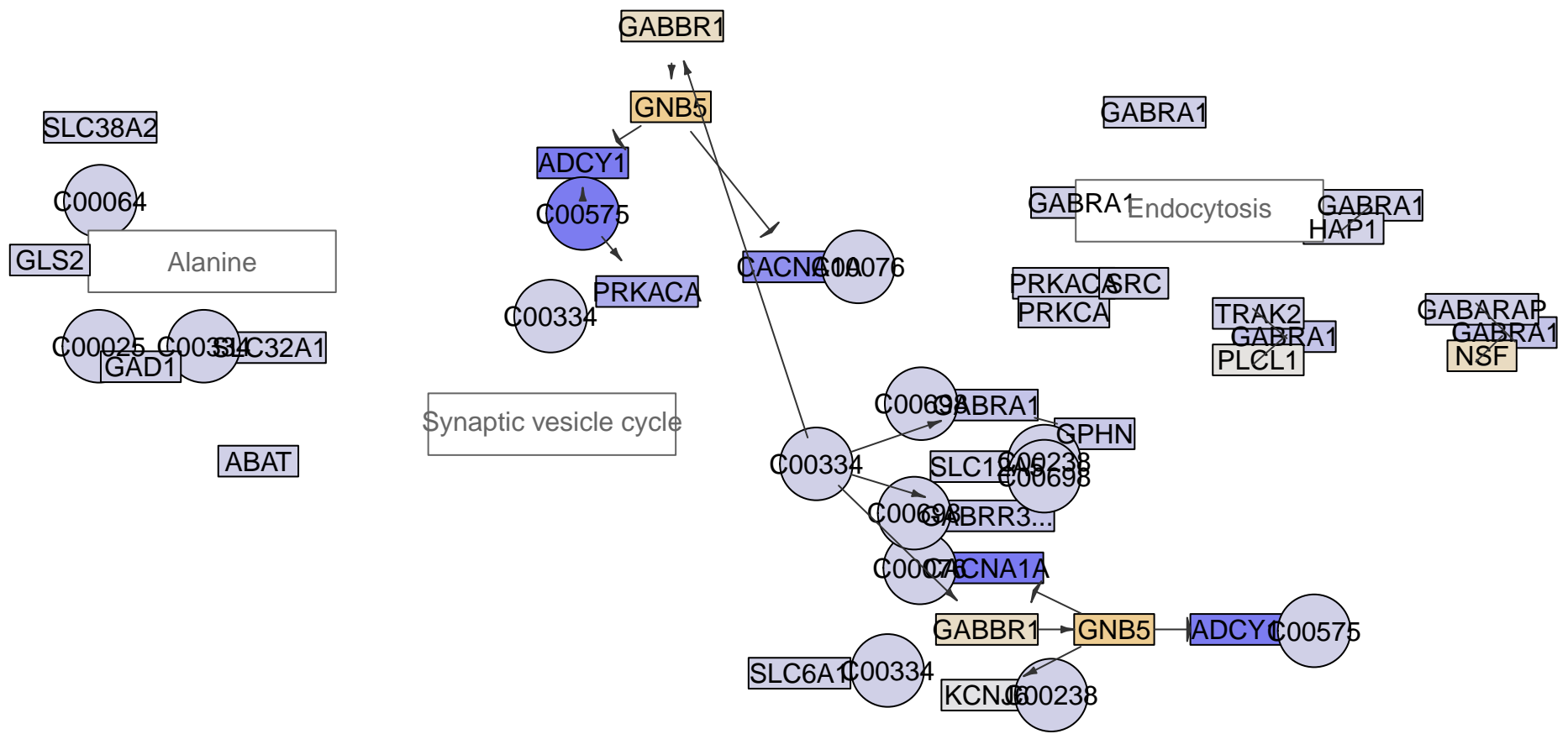

GABAergic synapse
MPI-255

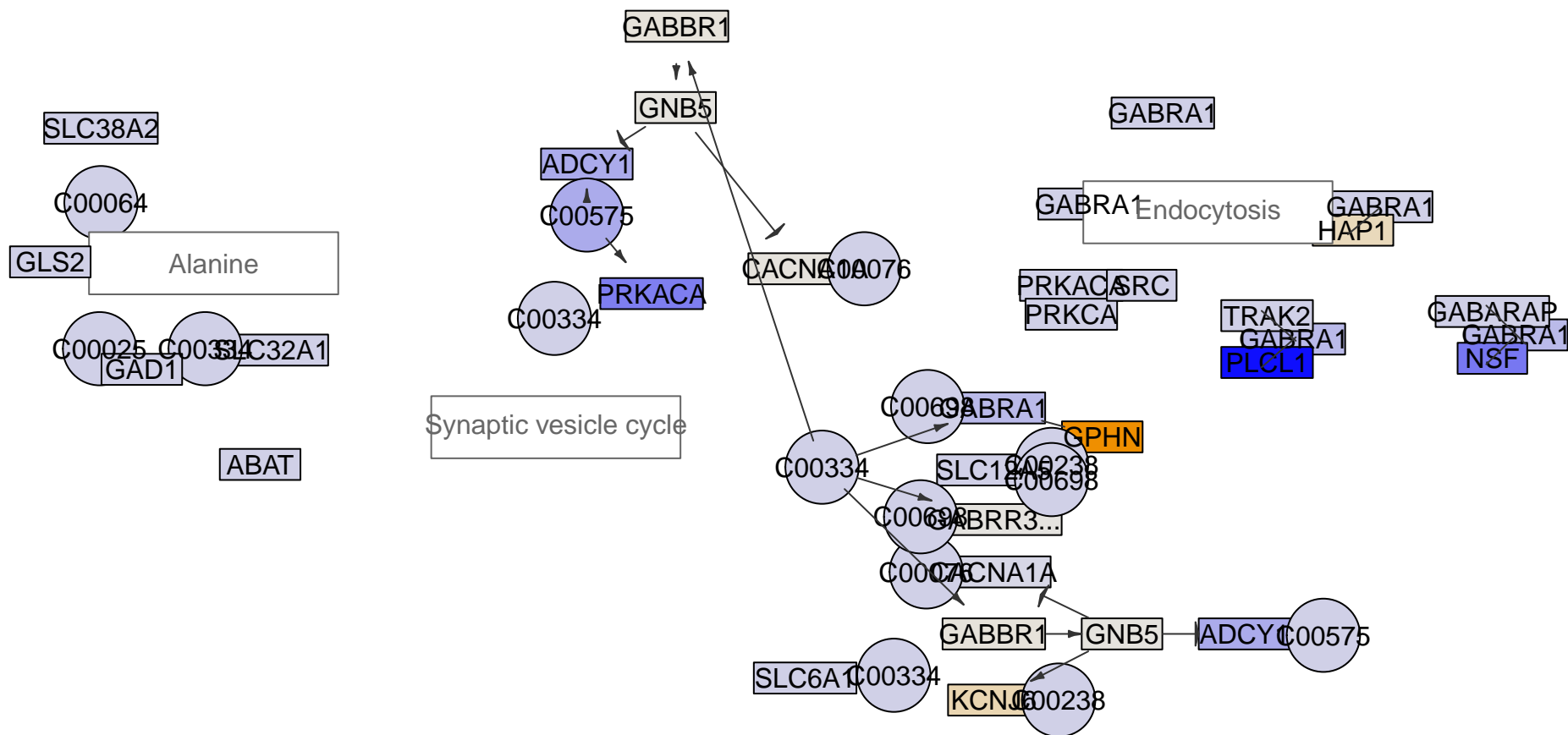
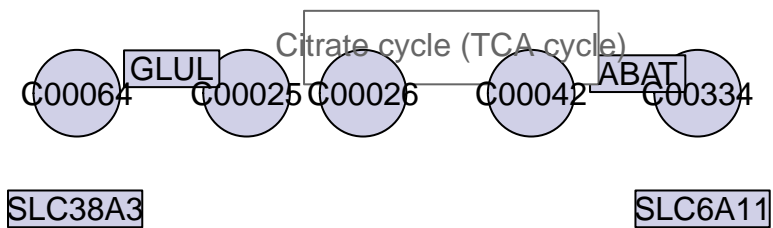

GABAergic synapse
MPI-223b

