

# Viral carcinogenesis

all genes

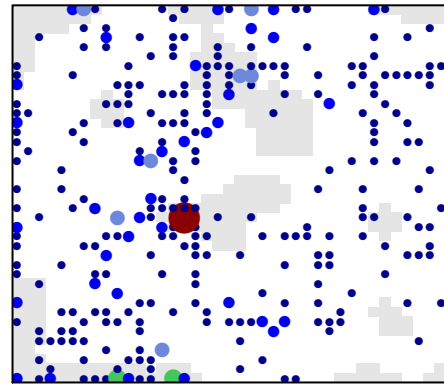

sink node genes

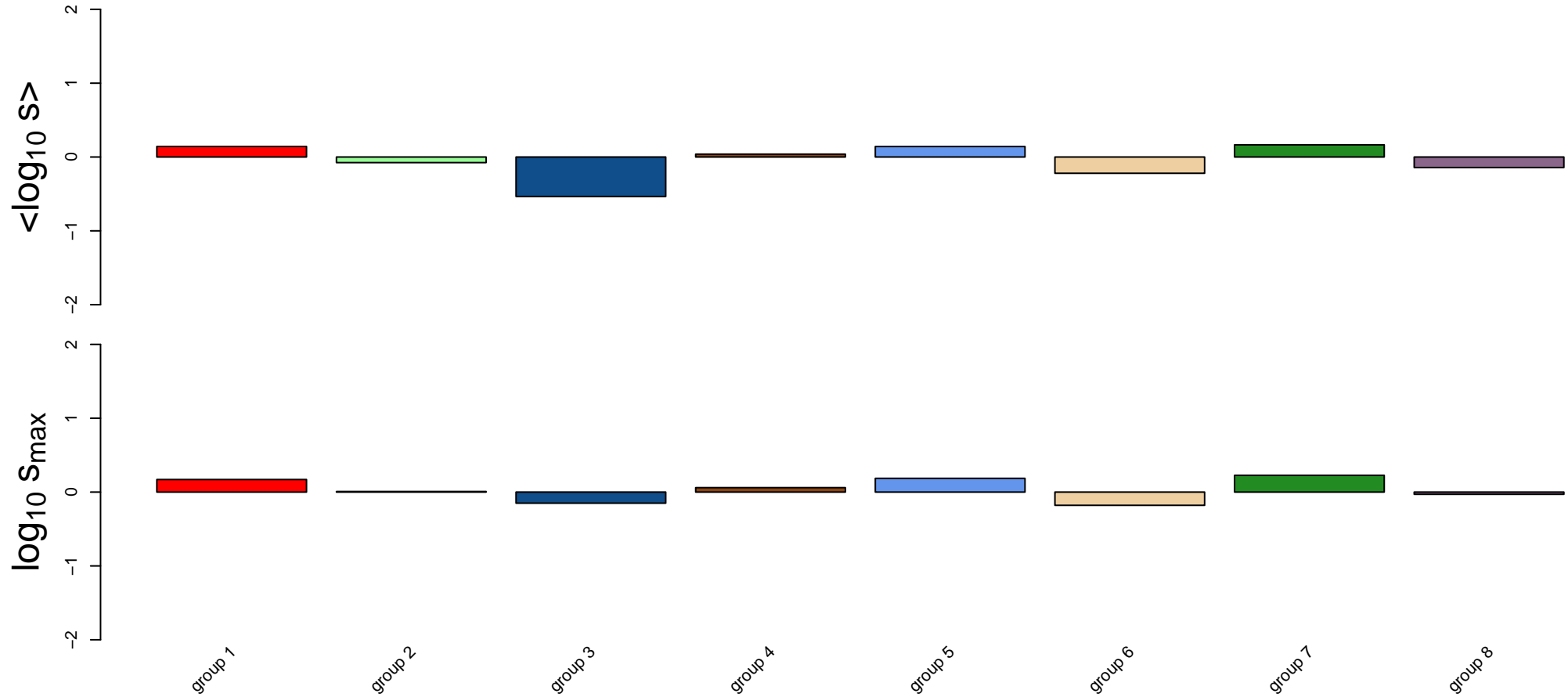
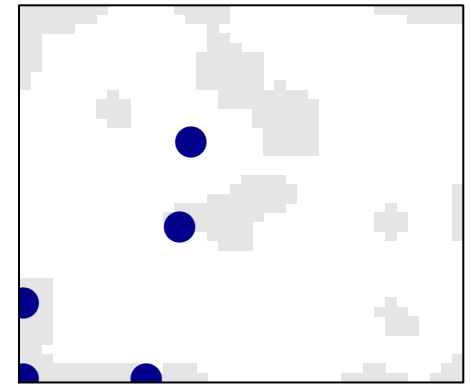

**Viral carcinogenesis genes-with data**

**Hepatitis B virus (HBV)**

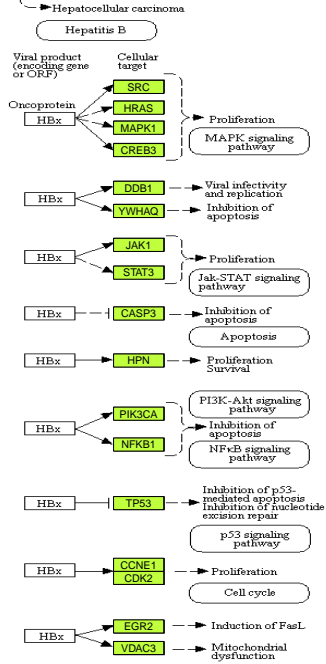

**Hepatitis C virus (HCV)**

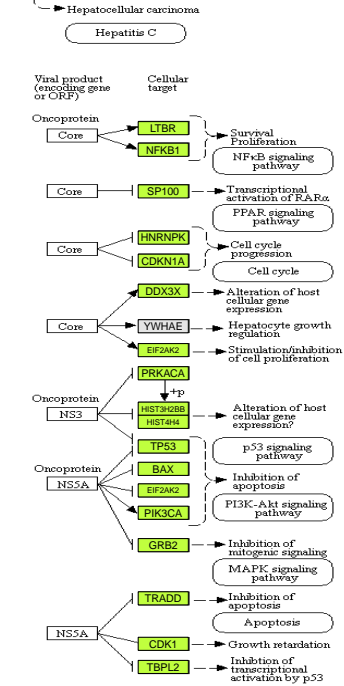

**Epstein-Barr virus (EBV)**

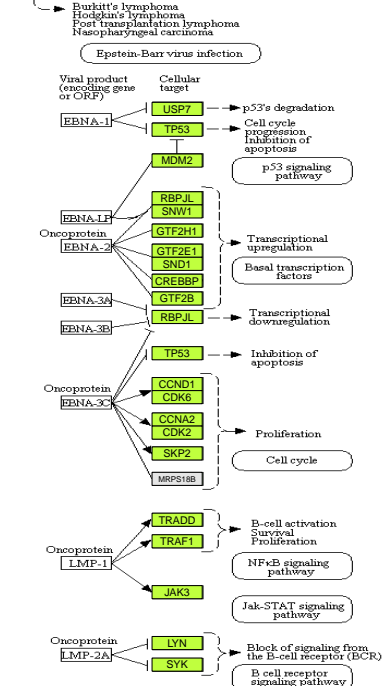

**Human papillomavirus (HPV)**

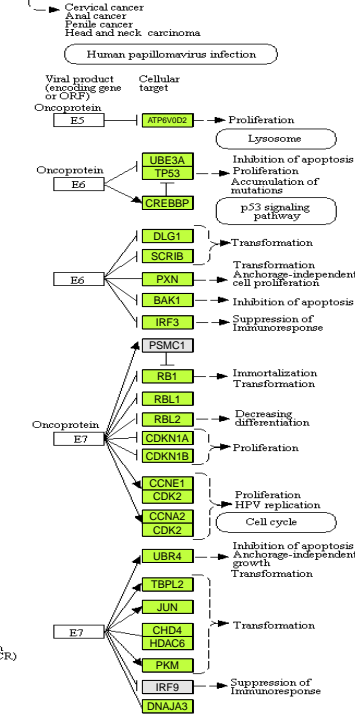

**Human T lymphotropic virus type I (HTLV-I)**

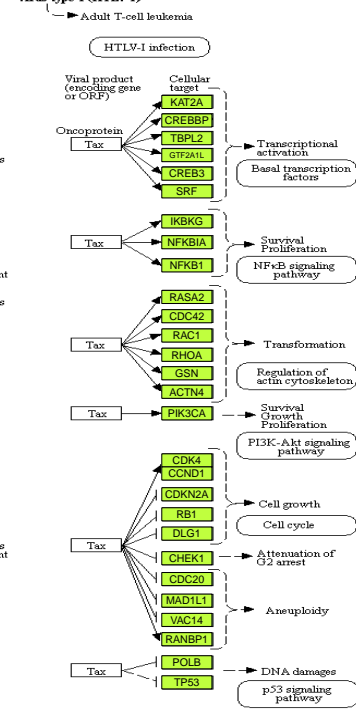

**Kaposi's sarcoma-associated herpesvirus (KSHV)**

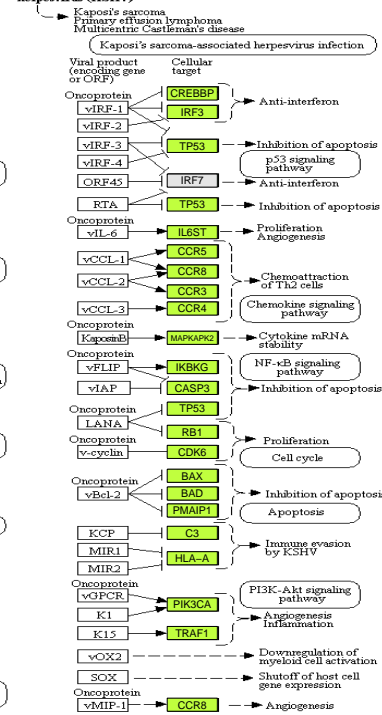

**Viral carcinogenesis sink nodes**

**Hepatitis B virus (HBV)**

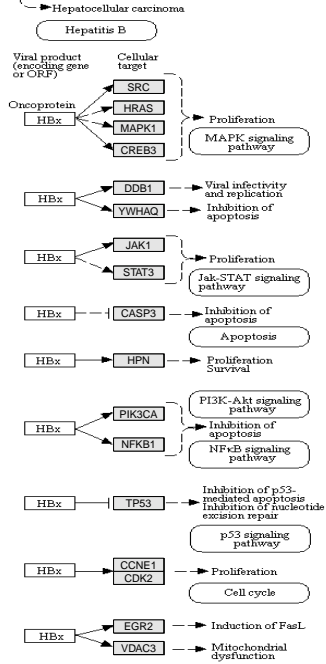

**Hepatitis C virus (HCV)**

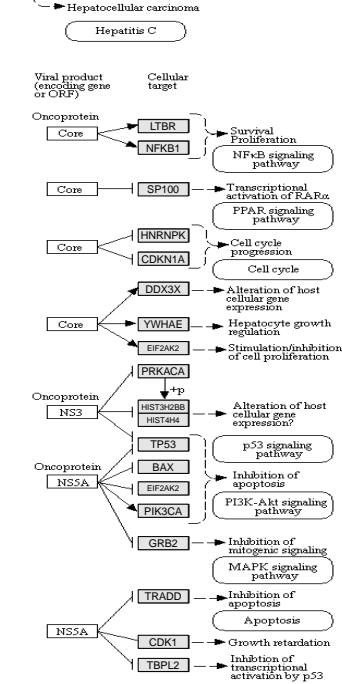

**Epstein-Barr virus (EBV)**

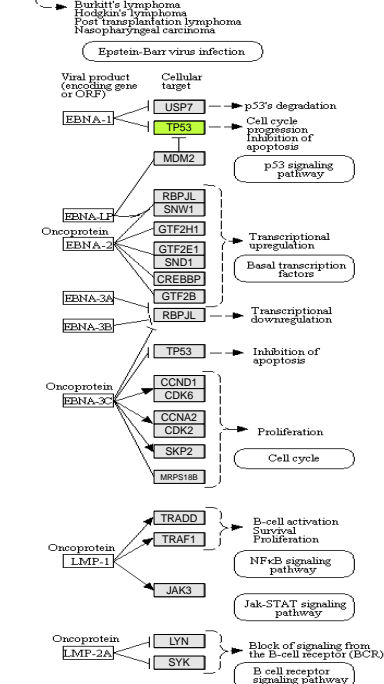

**Human papillomavirus (HPV)**

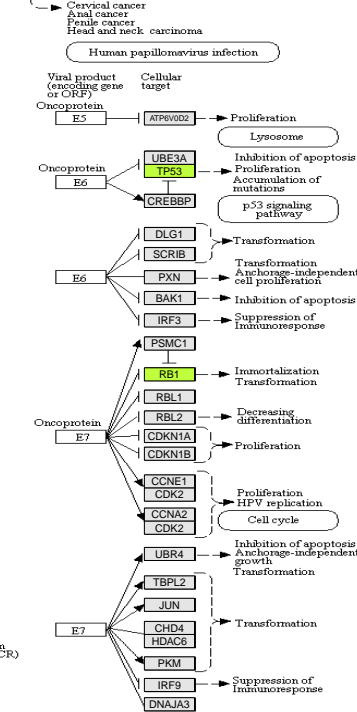

**Human T lymphotropic virus type I (HTLV-I)**

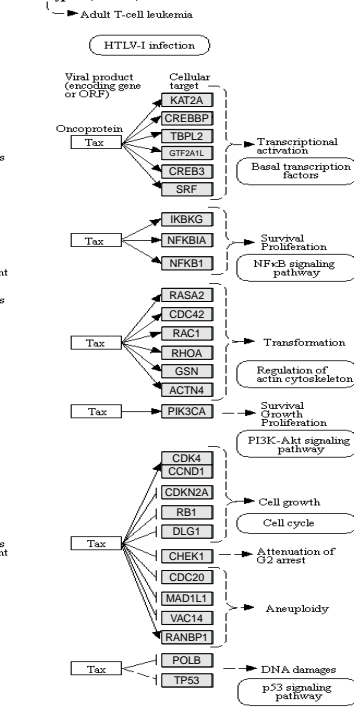

**Kaposi's sarcoma-associated herpesvirus (KSHV)**

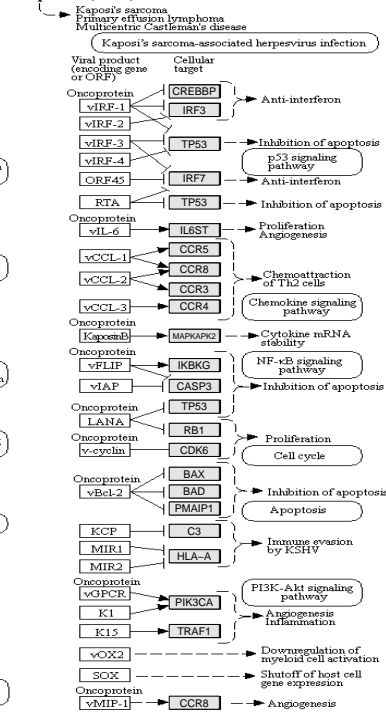

**Viral carcinogenesis  
influencer genes**

**Hepatitis B virus (HBV)**

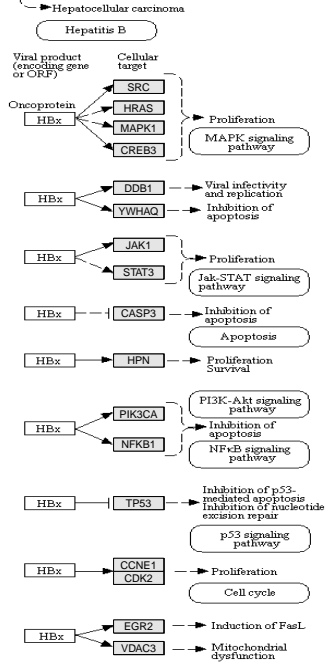

**Hepatitis C virus (HCV)**

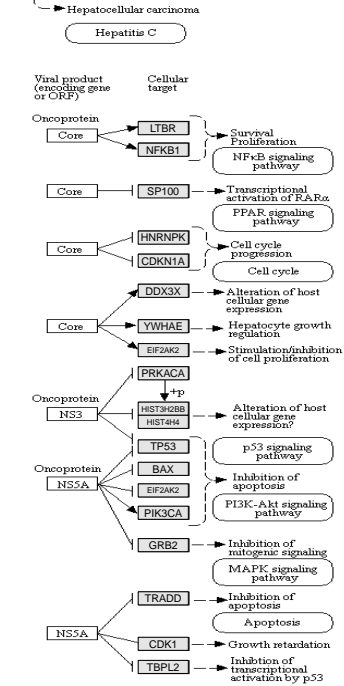

**Epstein-Barr virus (EBV)**

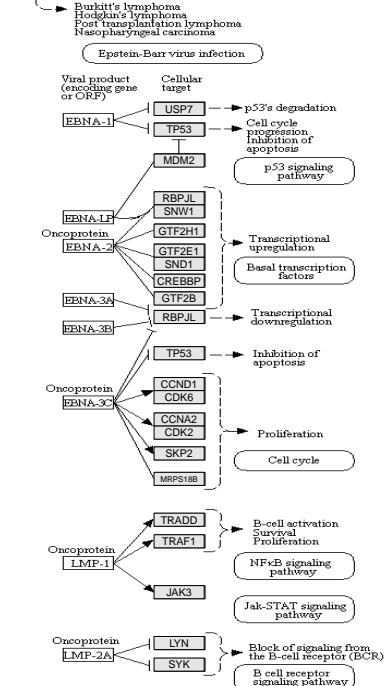

**Human papillomavirus (HPV)**

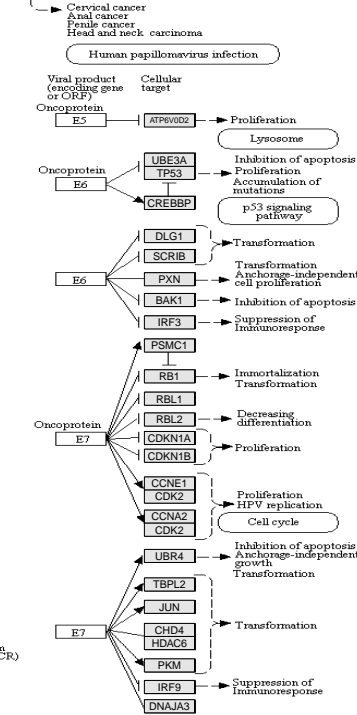

**Human T lymphotropic virus type I (HTLV-I)**

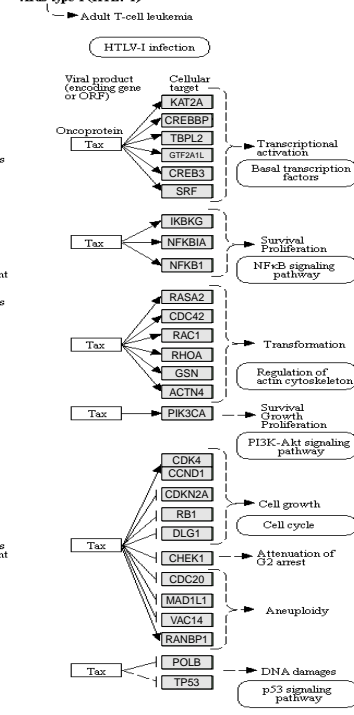

**Kaposi's sarcoma-associated herpesvirus (KSHV)**

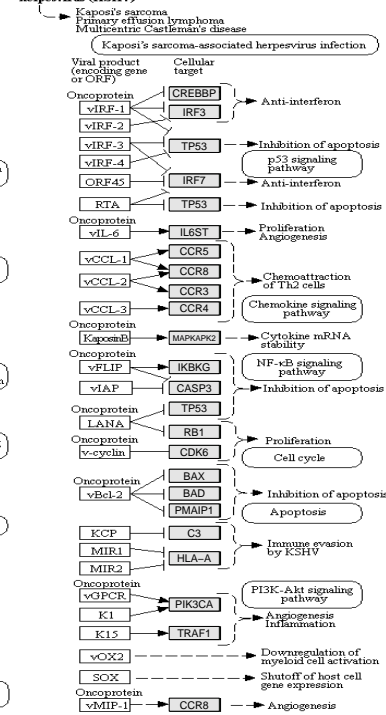

**Virul carcinogenesis group 1**

**Hepatitis B virus (HBV)**

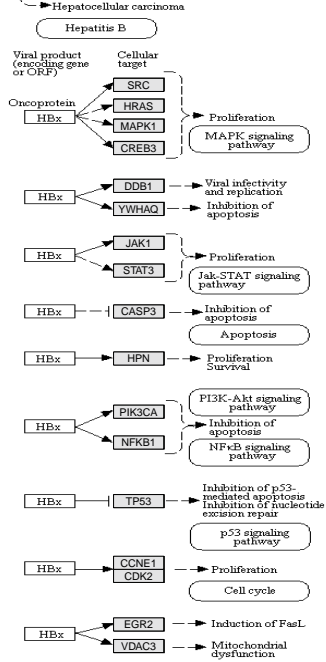

**Hepatitis C virus (HCV)**

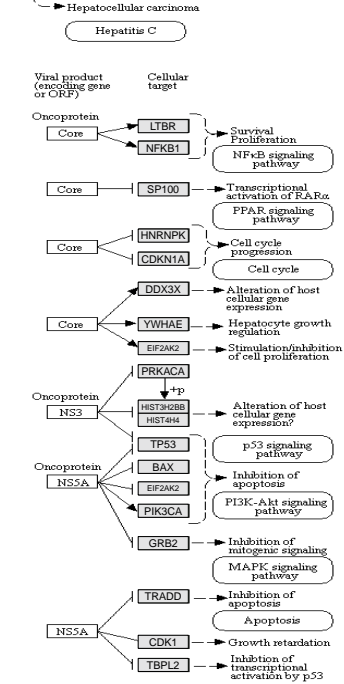

**Epstein-Barr virus (EBV)**

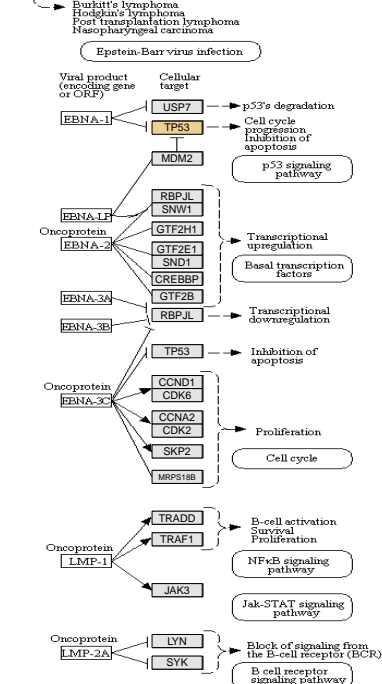

**Human papillomavirus (HPV)**

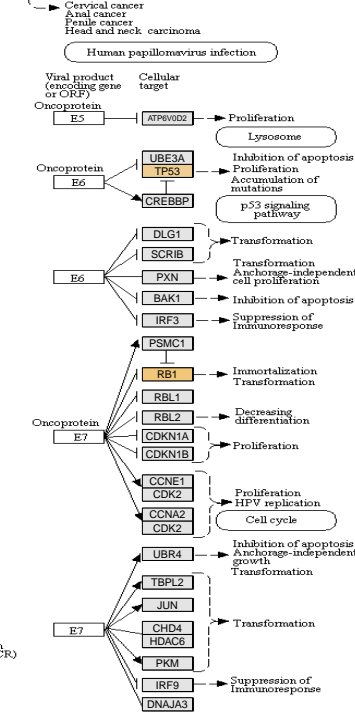

**Human T lymphotropic virus type 1 (HTLV-1)**

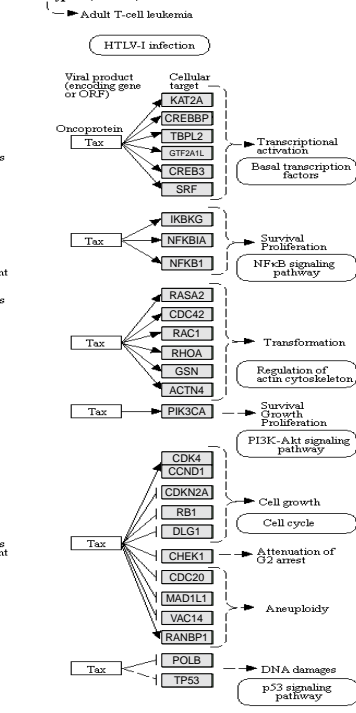

**Kaposi's sarcoma-associated herpesvirus (KSHV)**

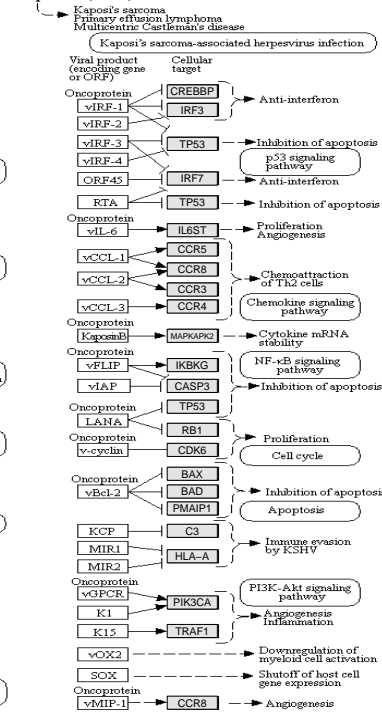

**Virul carcinogenesis group 2**

**Hepatitis B virus (HBV)**

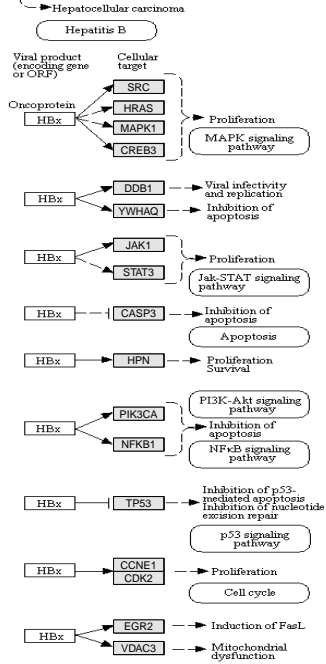

**Hepatitis C virus (HCV)**

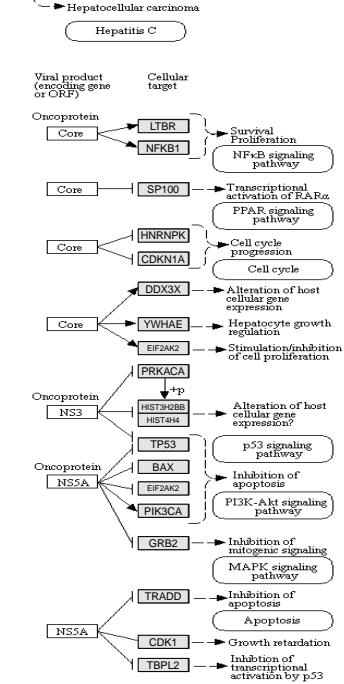

**Epstein-Barr virus (EBV)**

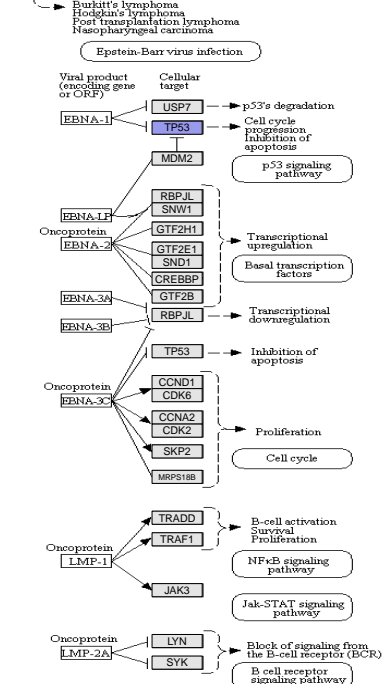

**Human papillomavirus (HPV)**

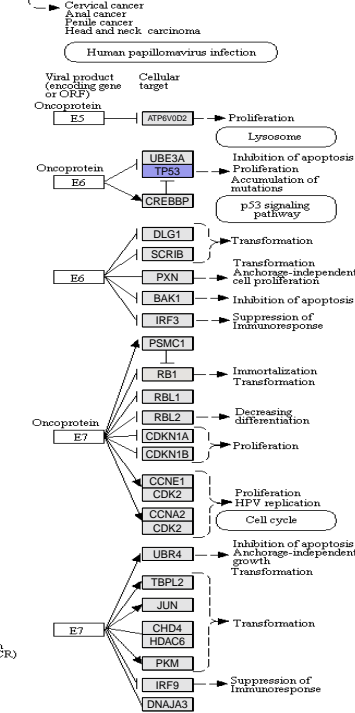

**Human T lymphotropic virus type 1 (HTLV-1)**

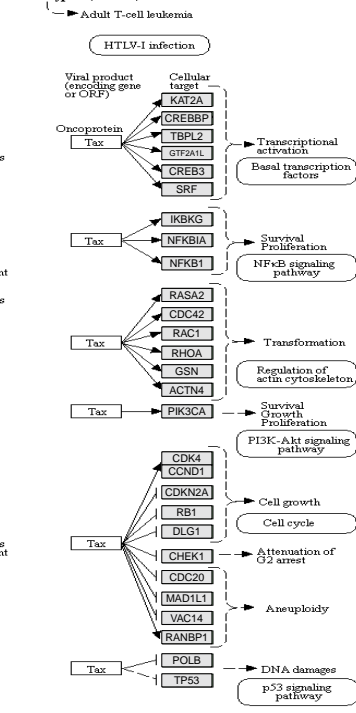

**Kaposi's sarcoma-associated herpesvirus (KSHV)**

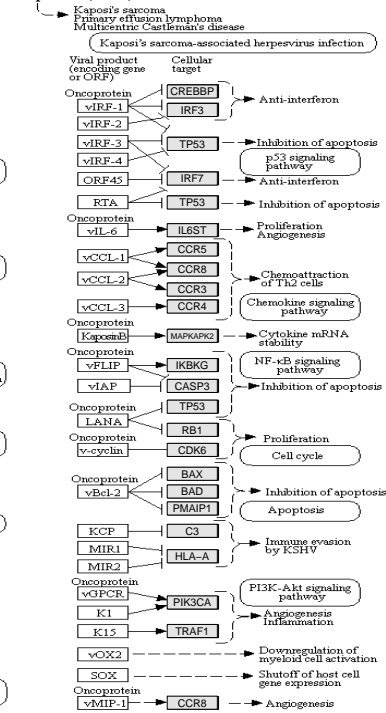

**Virul carcinogenesis group 3**

**Hepatitis B virus (HBV)**

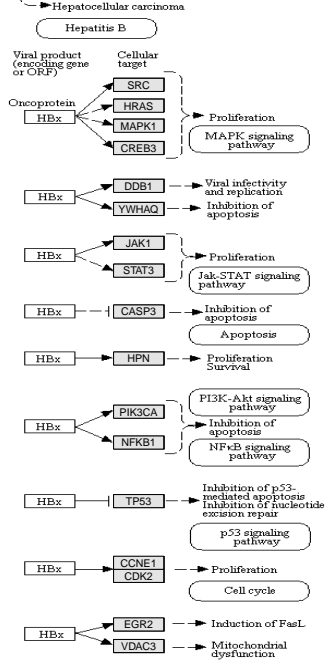

**Hepatitis C virus (HCV)**

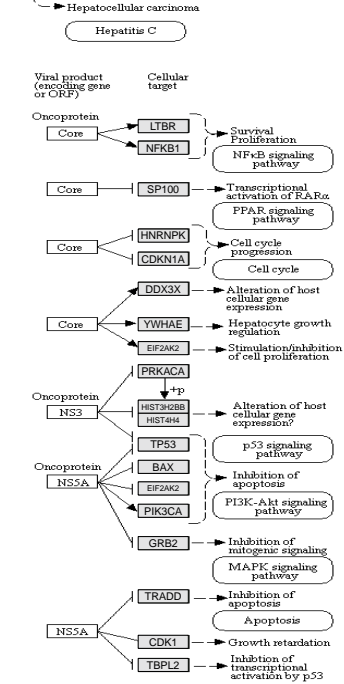

**Epstein-Barr virus (EBV)**

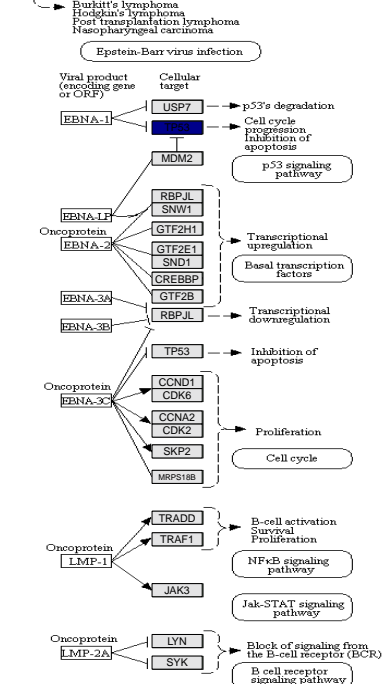

**Human papillomavirus (HPV)**

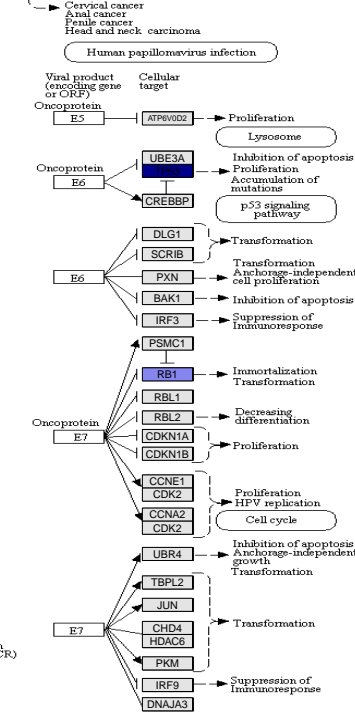

**Human T lymphotropic virus type 1 (HTLV-1)**

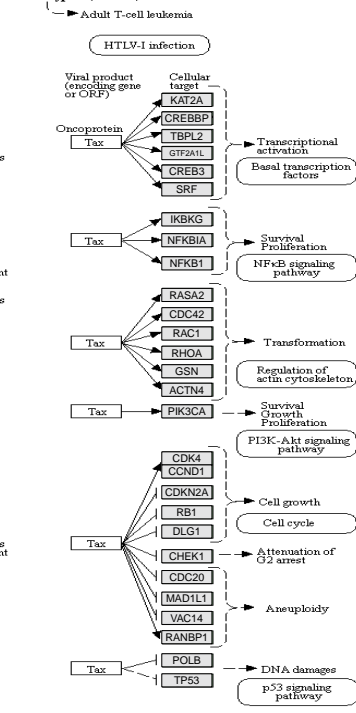

**Kaposi's sarcoma-associated herpesvirus (KSHV)**

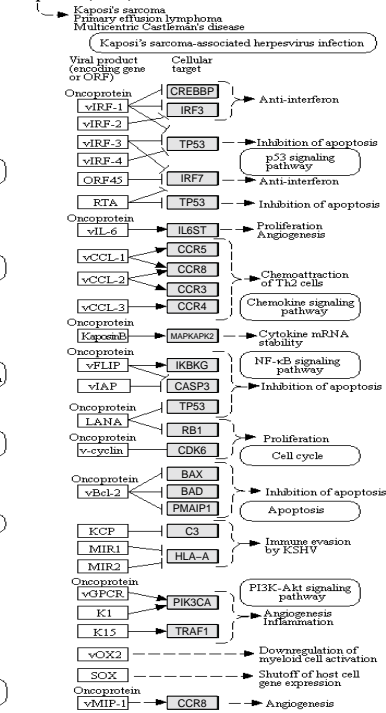



**Virul carcinogenesis group 4**

**Hepatitis B virus (HBV)**

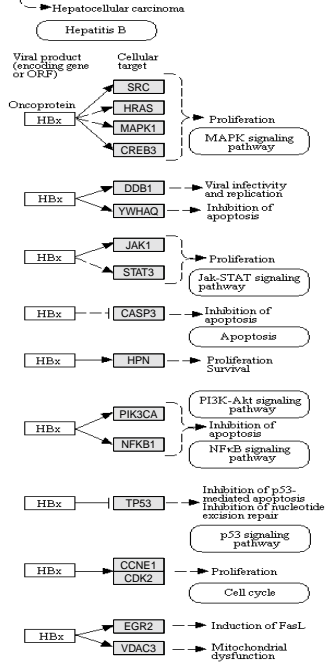

**Hepatitis C virus (HCV)**

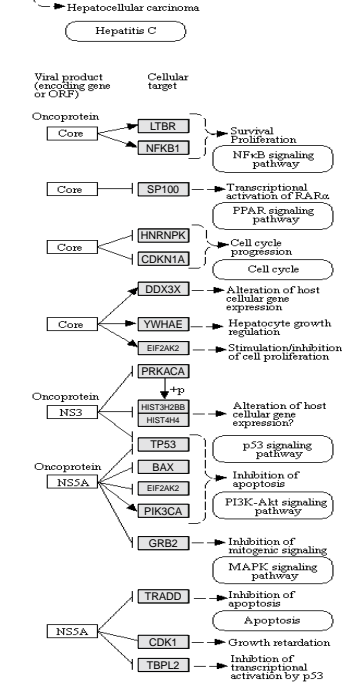

**Epstein-Barr virus (EBV)**

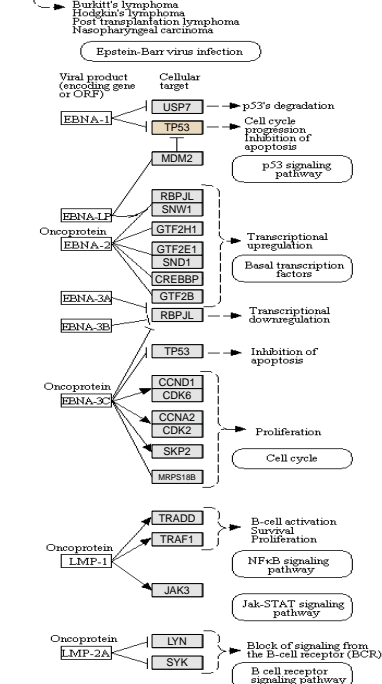

**Human papillomavirus (HPV)**

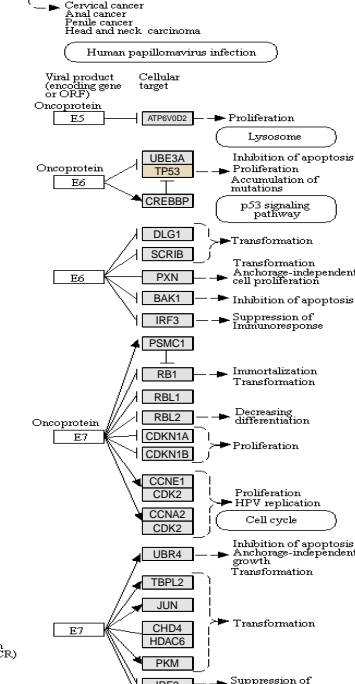

**Human T lymphotropic virus type 1 (HTLV-1)**

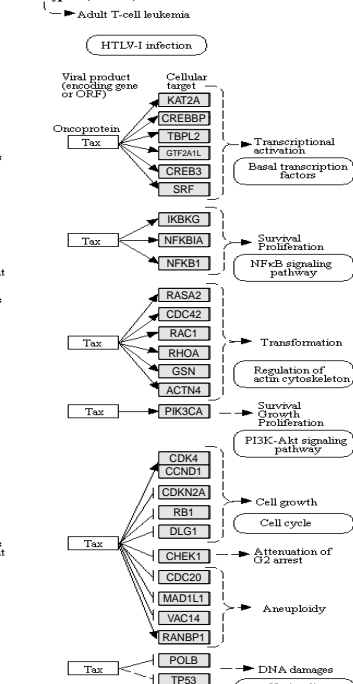

**Kaposi's sarcoma-associated herpesvirus (KSHV)**

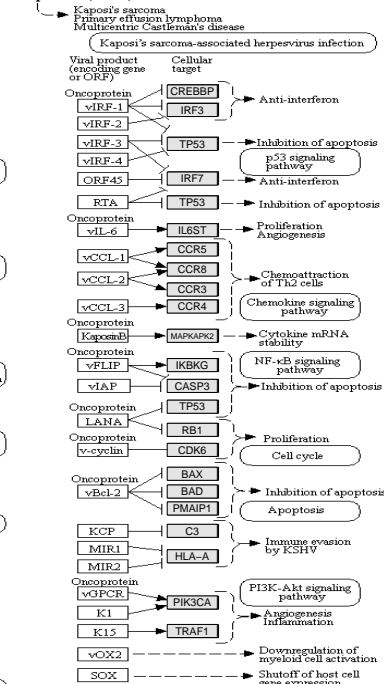



**Virul carcinogenesis group 6**

**Hepatitis B virus (HBV)**

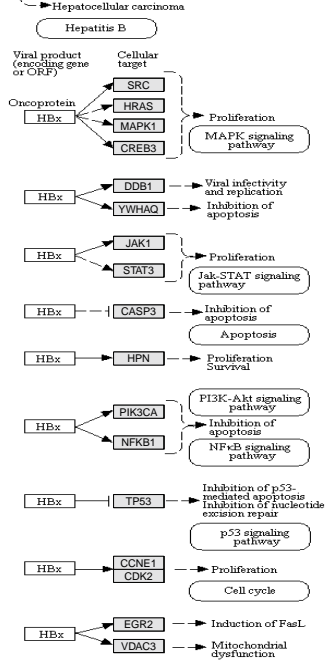

**Hepatitis C virus (HCV)**

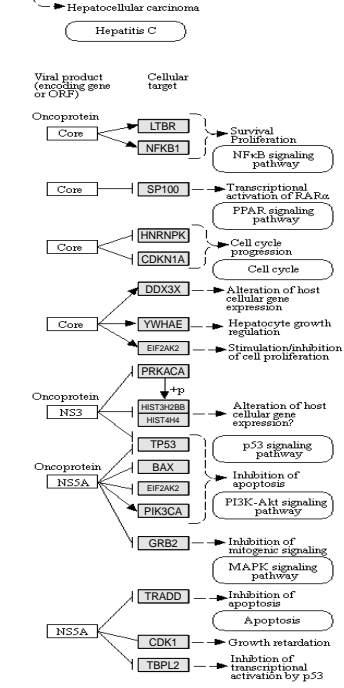

**Epstein-Barr virus (EBV)**

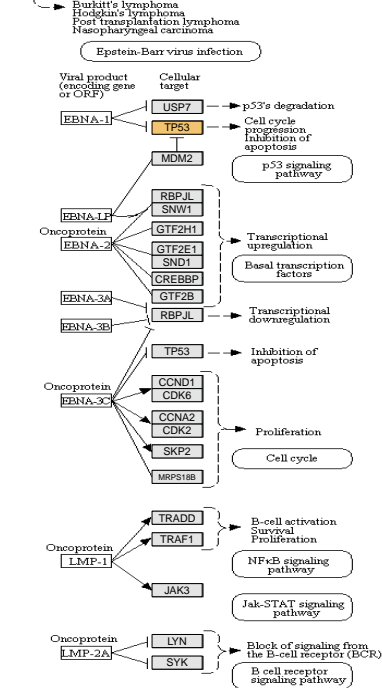

**Human papillomavirus (HPV)**

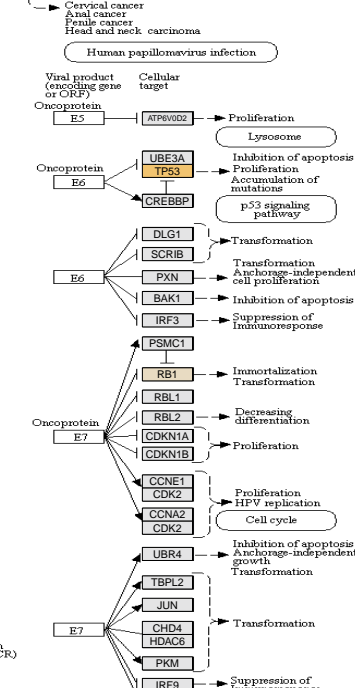

**Human T lymphotropic virus type 1 (HTLV-1)**

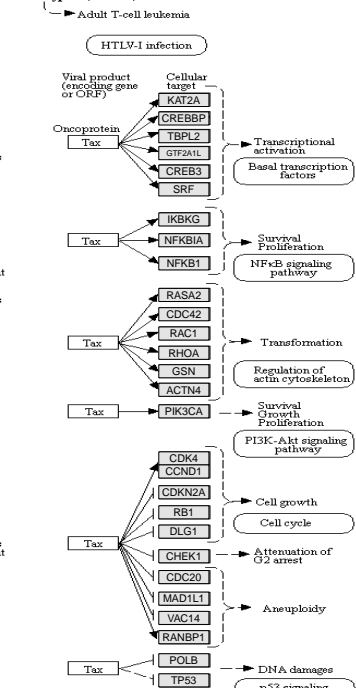

**Kaposi's sarcoma-associated herpesvirus (KSHV)**

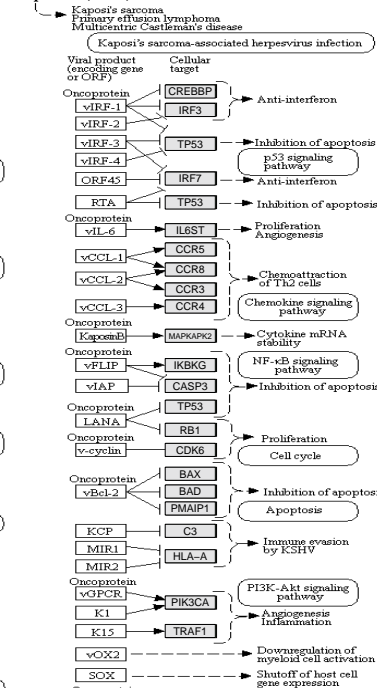

**Virul carcinogenesis group 6**

**Hepatitis B virus (HBV)**

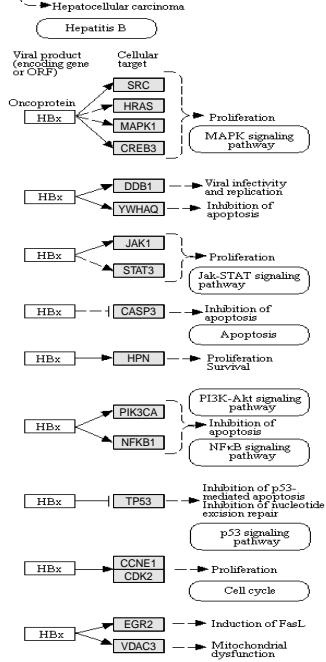

**Hepatitis C virus (HCV)**

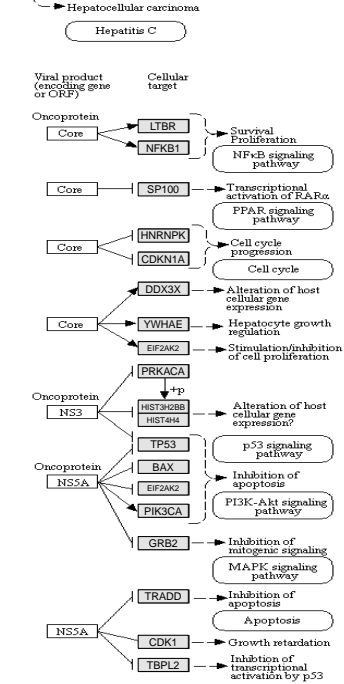

**Epstein-Barr virus (EBV)**

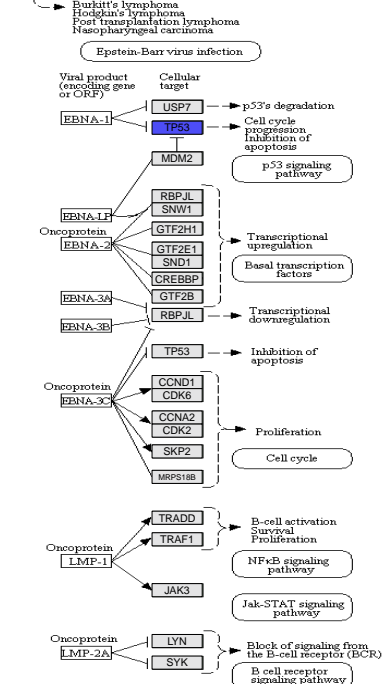

**Human papillomavirus (HPV)**

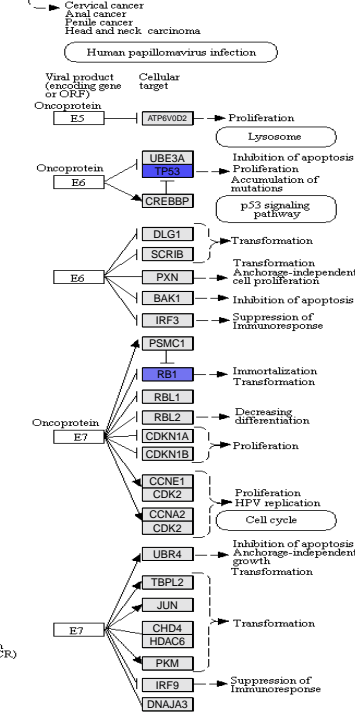

**Human T lymphotropic virus type 1 (HTLV-1)**

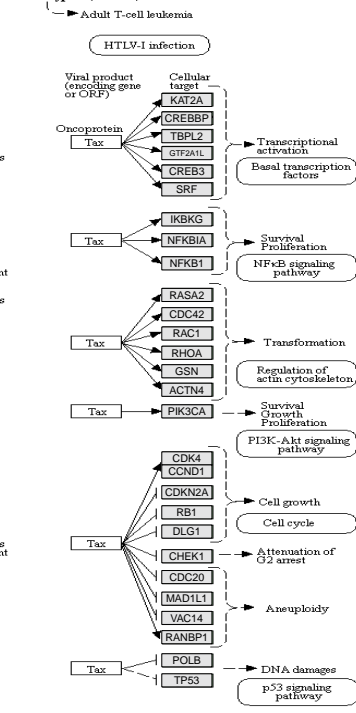

**Kaposi's sarcoma-associated herpesvirus (KSHV)**

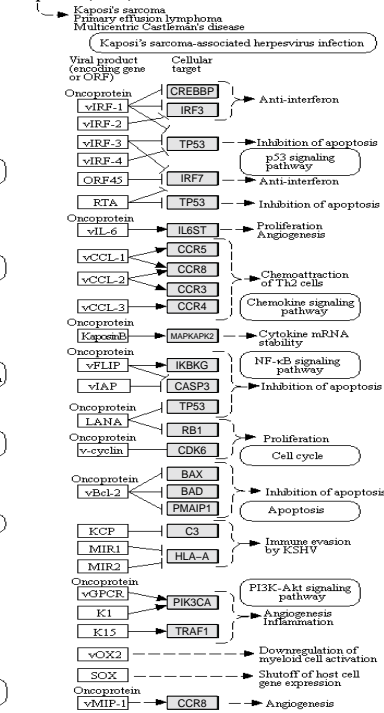

**Virul carcinogenesis group 7**

**Hepatitis B virus (HBV)**

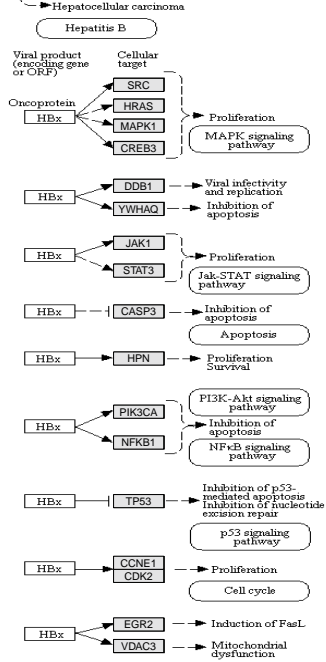

**Hepatitis C virus (HCV)**

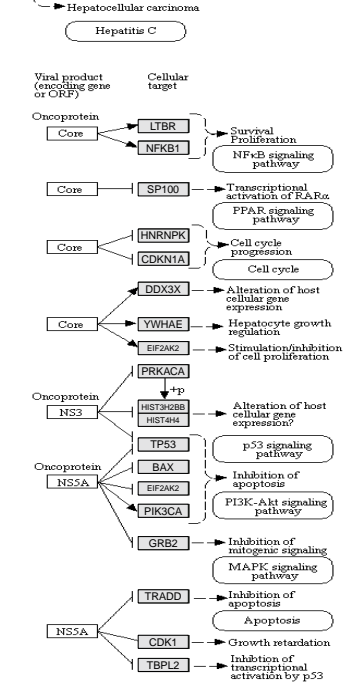

**Epstein-Barr virus (EBV)**

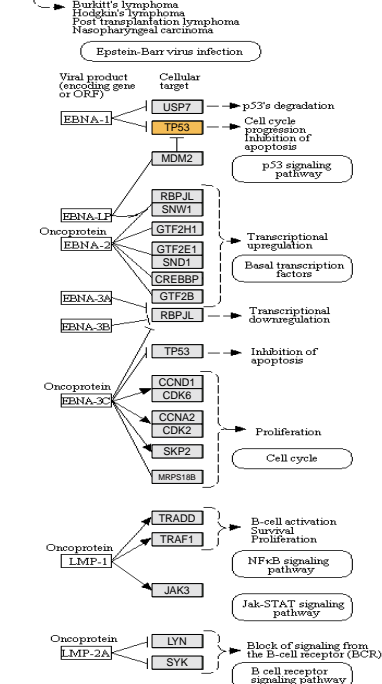

**Human papillomavirus (HPV)**

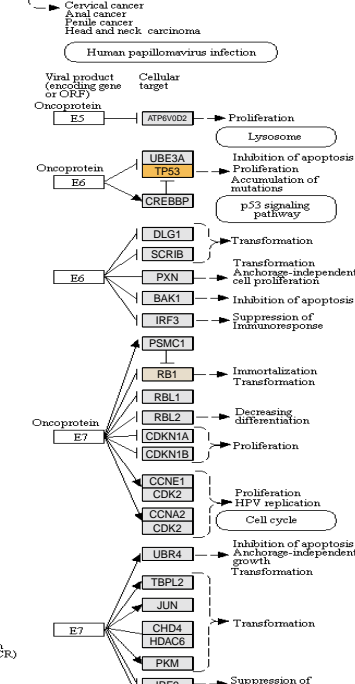

**Human T lymphotropic virus type 1 (HTLV-1)**

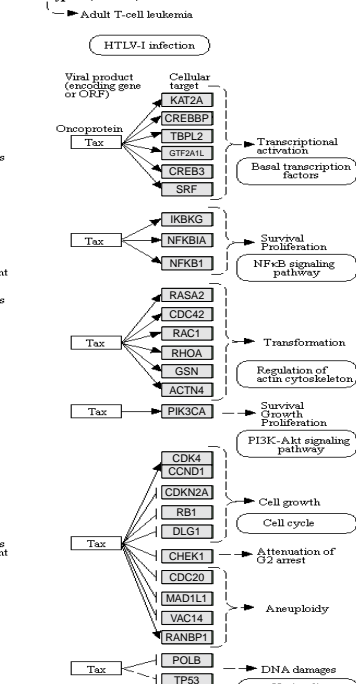

**Kaposi's sarcoma-associated herpesvirus (KSHV)**

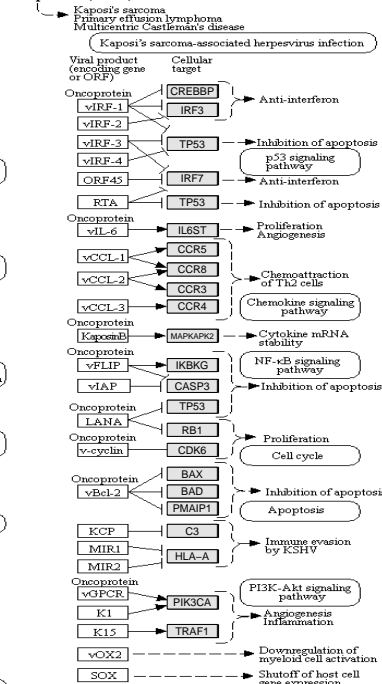

**Virul carcinogenesis group 8**

**Hepatitis B virus (HBV)**

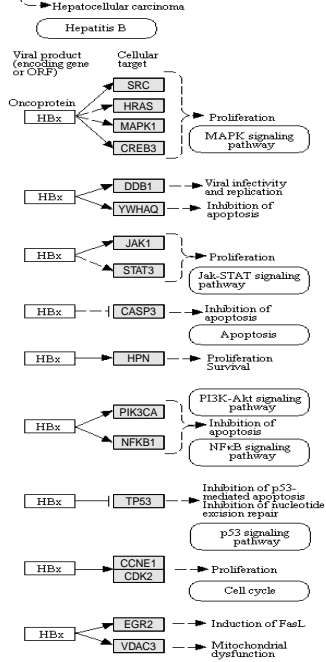

**Hepatitis C virus (HCV)**

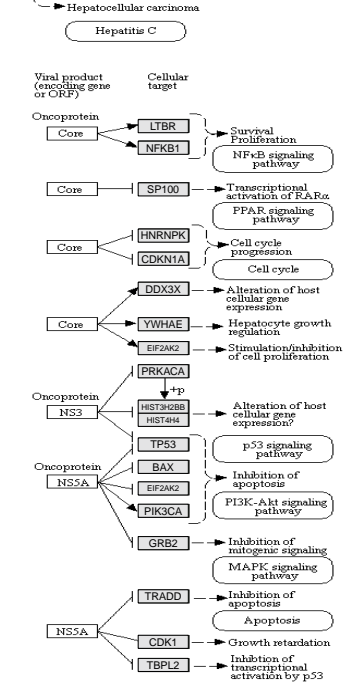

**Epstein-Barr virus (EBV)**

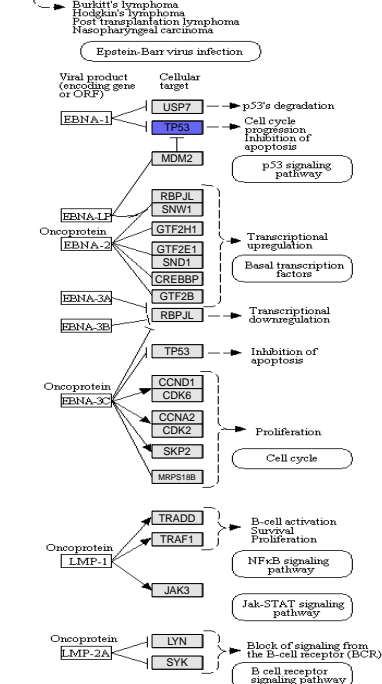

**Human papillomavirus (HPV)**

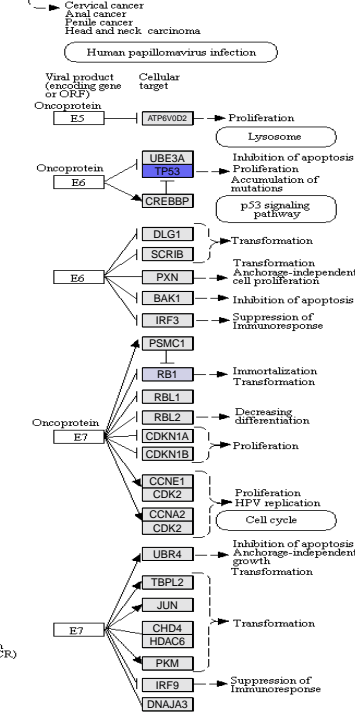

**Human T lymphotropic virus type I (HTLV-I)**

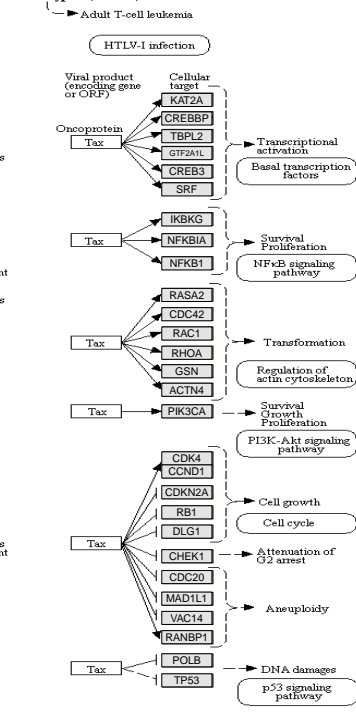

**Kaposi's sarcoma-associated herpesvirus (KSHV)**

