

Signaling pathways regulating pluripot

all genes

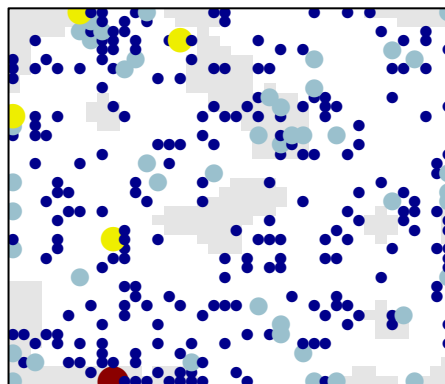

maximum = 4

sink node genes

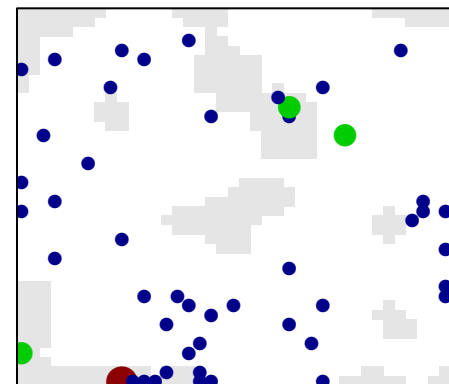

maximum = 3

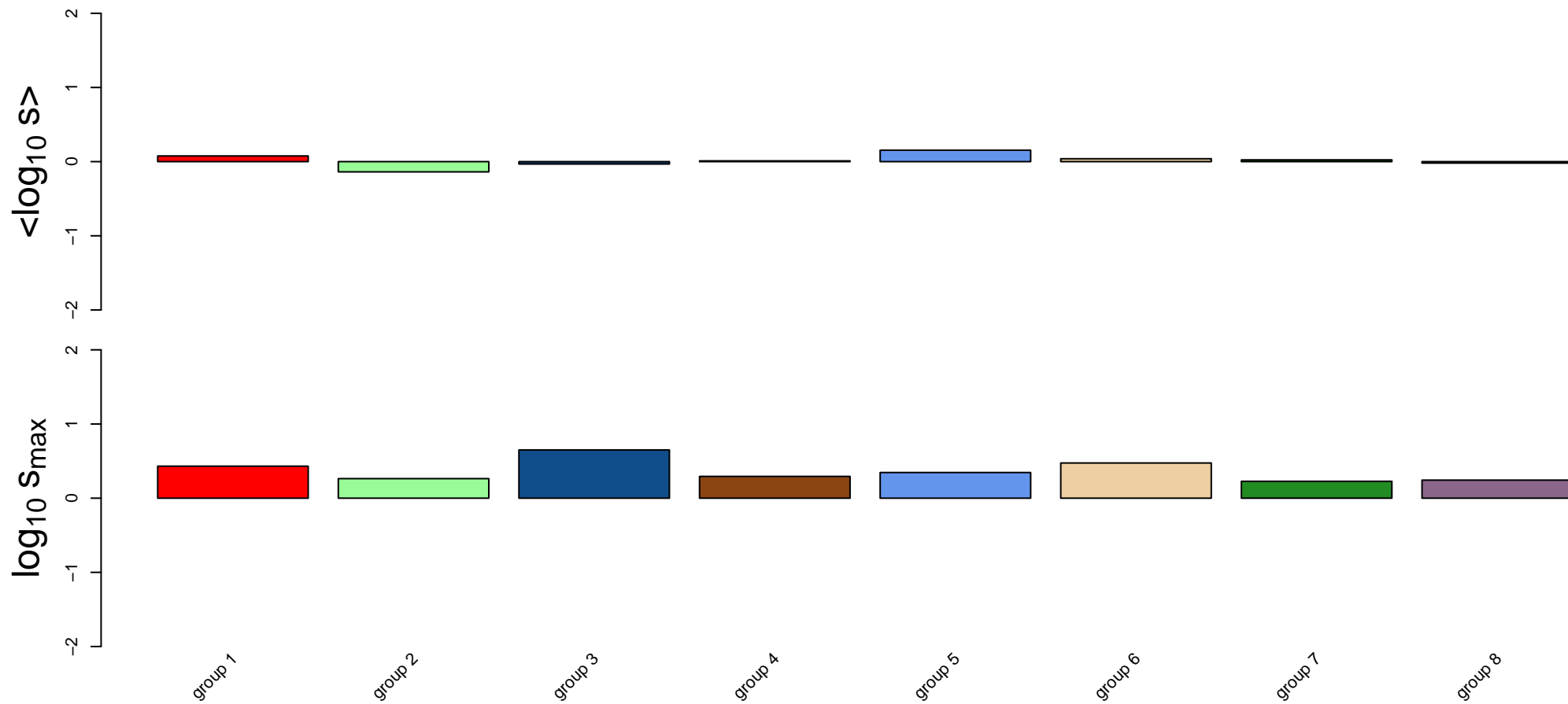

Naive stem cells

Mouse ES cells (mESCs)
Mouse iPS cells (miPSCs)

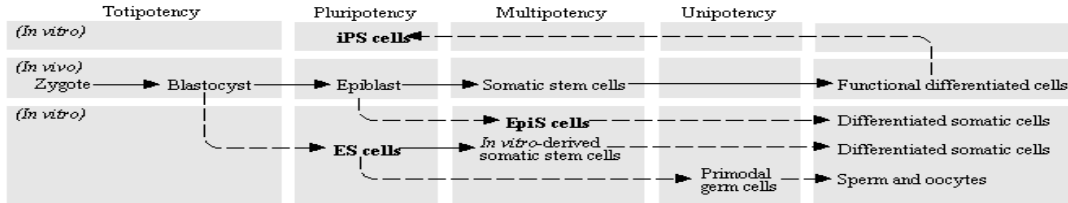
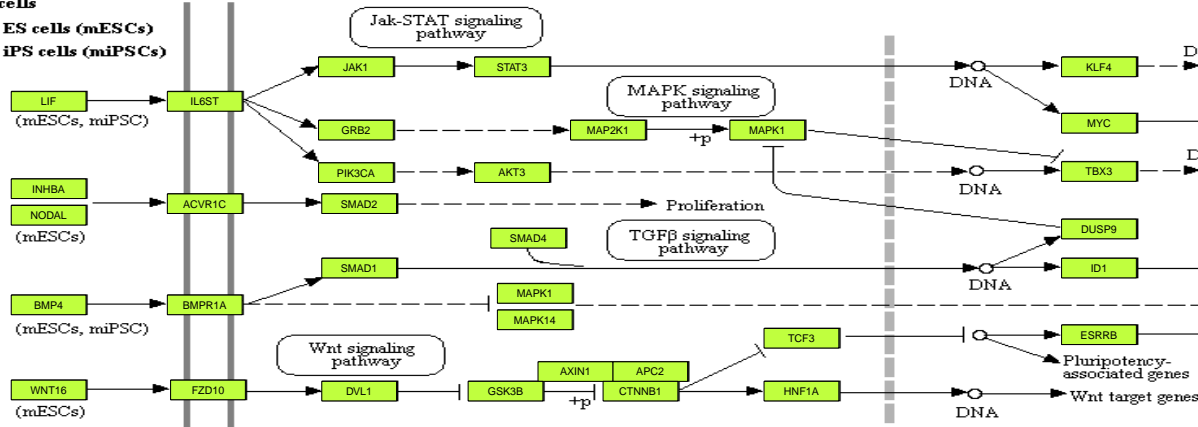

Primed stem cells

Human ES cells (hESCs)
Human iPS cells (hiPSCs)
Mouse EpiS cells (mEpiSCs)

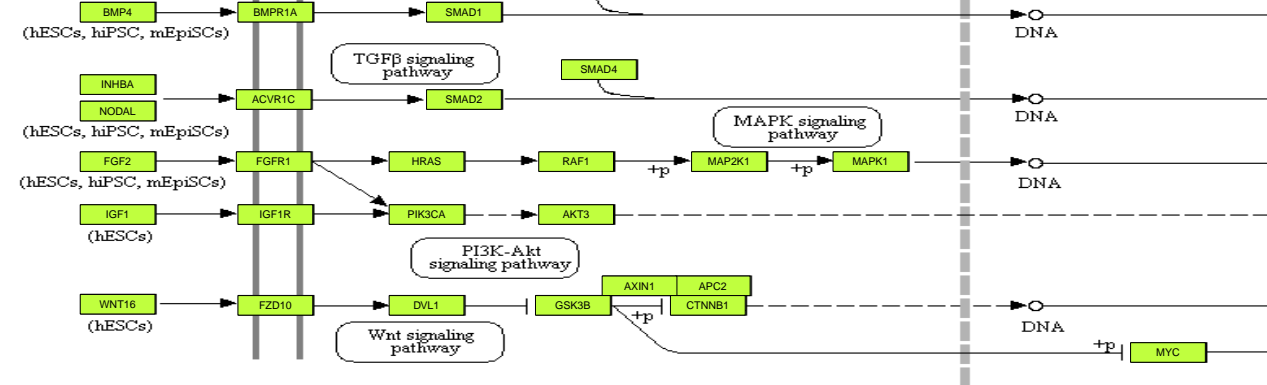

Core transcriptional network

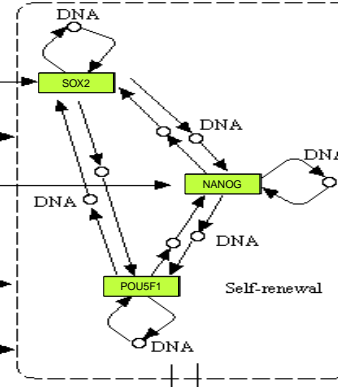

OCT4, SOX2, and NANOG target genes in human and/or mouse ES cells

- Key pluripotency genes**
 - POU5F1, SOX2, NANOG
- ES cell transcription factors**
 - STAT3, HESX1, ZIC3, ESRRB
- ES cell signaling**
 - TCF3, FGF2, LEFTY2, SKIL
- Epigenetic regulators**
 - SMARCA4, KAT6A, SETDB1, JARID2
- Inhibitor of neurogenesis**
 - REST
- Telomere-associated protein**
 - RIF1
- Pluripotency maintenance**
 - CCND3-BMI1
- Ectoderm development**
 - PAX6, MEIS1, HOXB1, LHX5, OTX1, NEUROG1
- Mesoderm development**
 - HAND1, DLX5, MYF5, ONECUT1
- Endoderm development**
 - ISL1, ZFX3
- Extra-embryonic development**
 - ESX1

Signaling pathways regulating pluripotency of stem cells
sink nodes

Naive stem cells

Mouse ES cells (mESCs)
Mouse iPSCs (miPSCs)

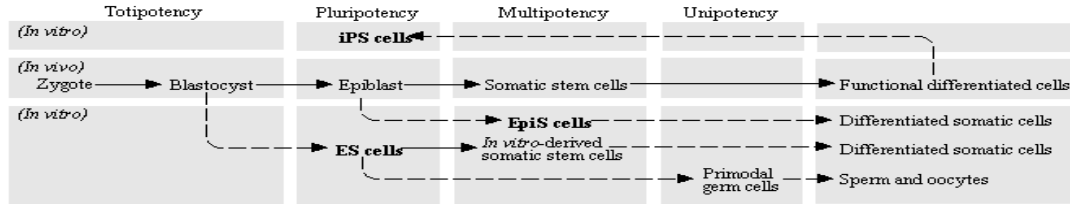
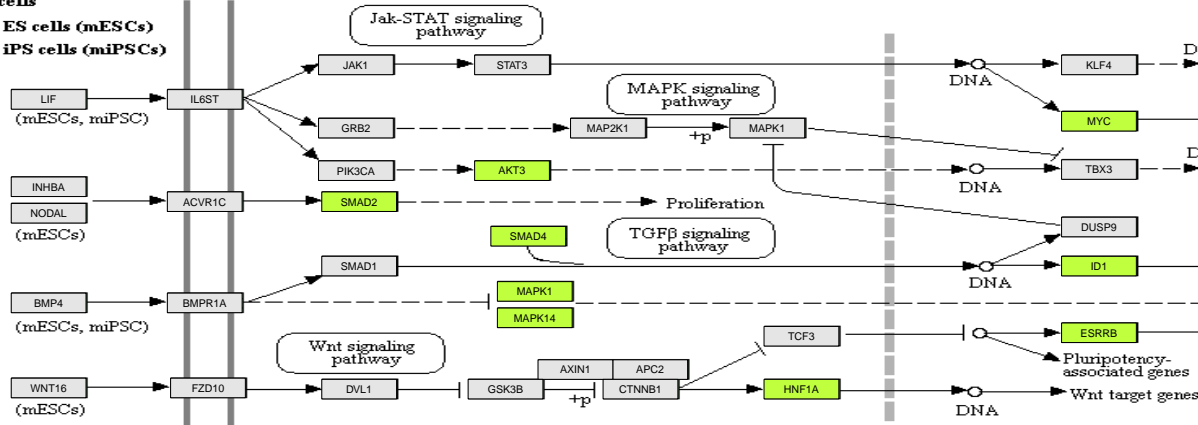

Primed stem cells

Human ES cells (hESCs)
Human iPSCs (hiPSCs)
Mouse EpiS cells (mEpiSCs)

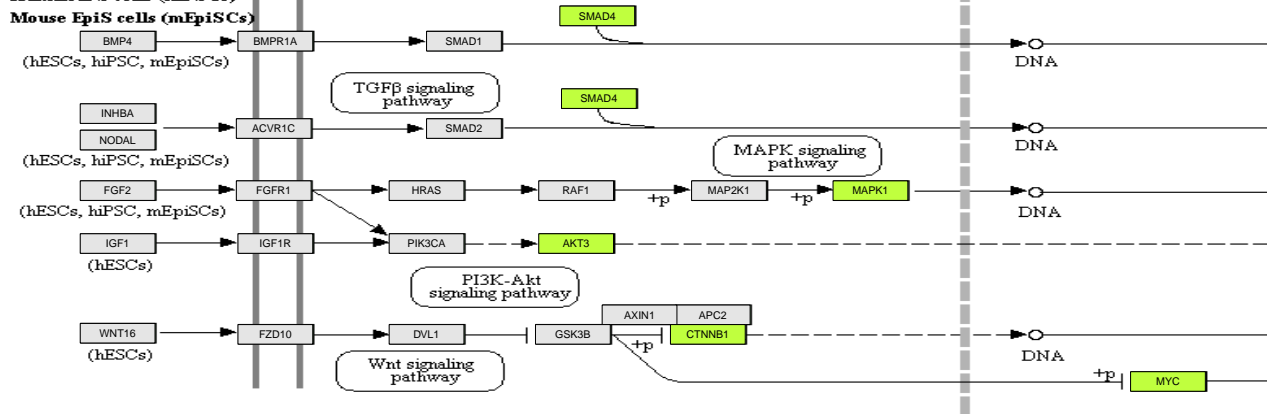

Core transcriptional network

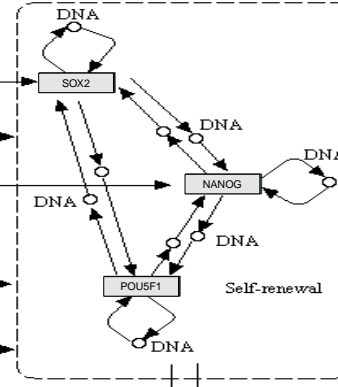

OCT4, SOX2, and NANOG target genes in human and/or mouse ES cells

- Key pluripotency genes: POU5F1, SOX2, NANOG
- ES cell transcription factors: STAT3, HESX1, ZIC3, ESRRB
- ES cell signaling: TCF3, FGF2, LEFTY2, SKIL
- Epigenetic regulators: SMARCA1, KAT6A, SETDB1, JARID2
- Inhibitor of neurogenesis: REST
- Telomere-associated protein: RIF1
- Pluripotency maintenance: COMMD3-BMI1
- Ectoderm development: PAX6, MEIS1, HOXB1, LHX5, OTX1, NEUROG1
- Mesoderm development: HAND1, DLX5, MYF5, ONECUT1
- Endoderm development: ISL1, ZFH3
- Extra-embryonic development: ESX1

Naive stem cells

Mouse ES cells (mESCs)
Mouse iPSCs (miPSCs)

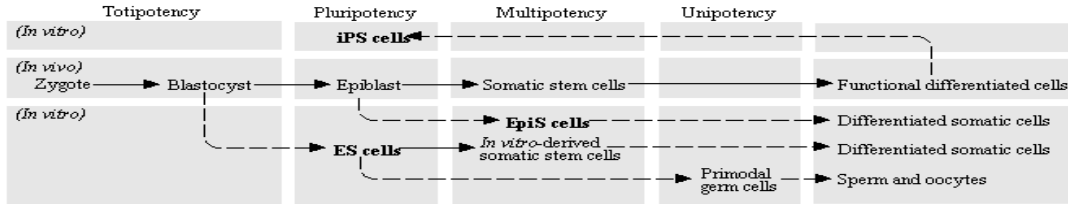
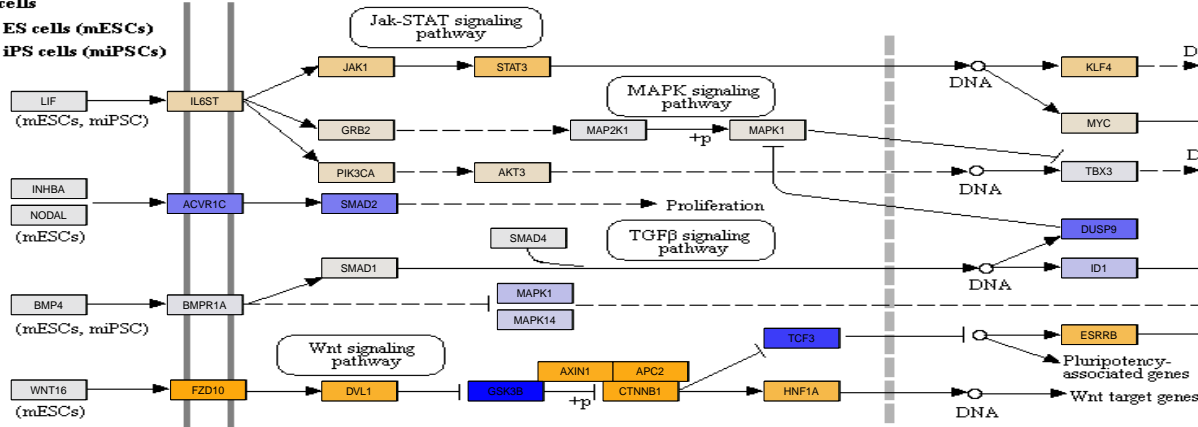

Primed stem cells

Human ES cells (hESCs)
Human iPSCs (hiPSCs)
Mouse EpiS cells (mEpiSCs)

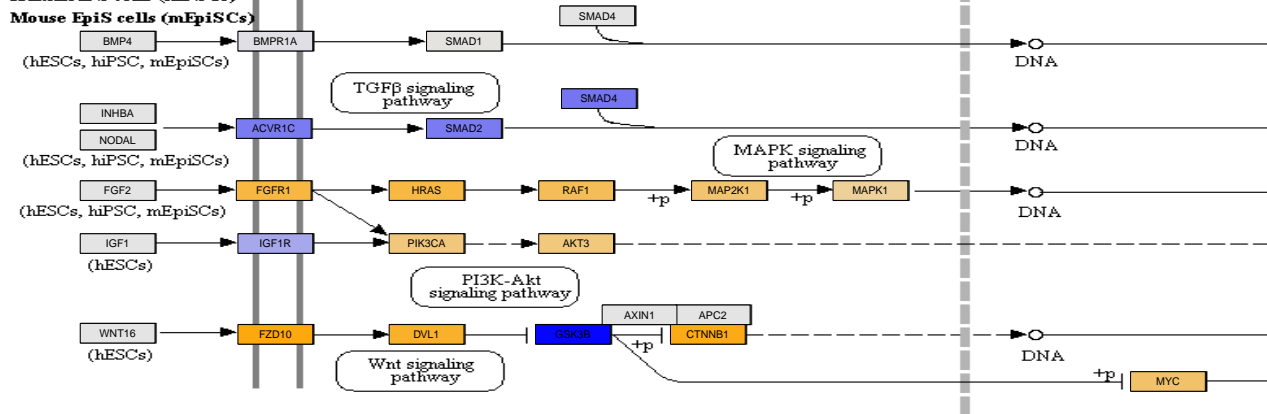

Core transcriptional network

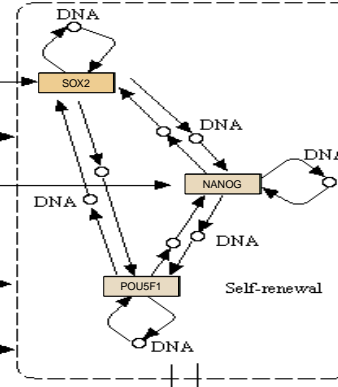

OCT4, SOX2, and NANOG target genes in human and/or mouse ES cells

- Key pluripotency genes**
 - POU5F1, SOX2, NANOG
- ES cell transcription factors**
 - STAT3, HESX1, ZIC3, ESRRB
- ES cell signaling**
 - TCF3, FGF2, LEFTY2, SKIL
- Epigenetic regulators**
 - SMARCA4, KAT6A, SETDB1, JARID2
- Inhibitor of neurogenesis**
 - REST
- Telomere-associated protein**
 - RIF1
- Pluripotency maintenance**
 - COMMD3-BM1
- Ectoderm development**
 - PAX6, MEIS1, HOXB1, LHX5, OTX1, NEUROG1
- Mesoderm development**
 - HAND1, DLX5, MYF5, ONECUT1
- Endoderm development**
 - ISL1, ZFH3
- Extra-embryonic development**
 - ESX1

Signaling_pathways_regulating_pluripotency_of_stem_cells
group 2

Naive stem cells

Mouse ES cells (mESCs)
Mouse iPSCs (miPSCs)

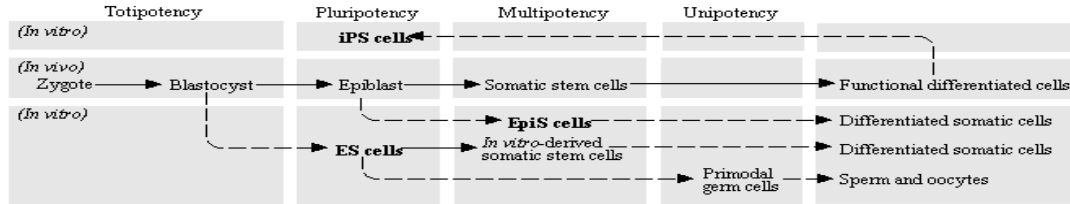
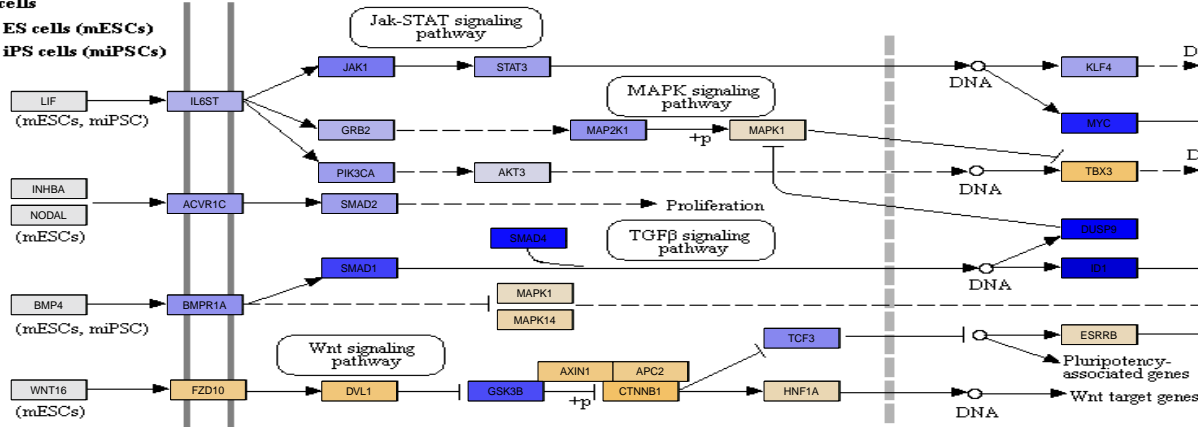

Primed stem cells

Human ES cells (hESCs)
Human iPSCs (hiPSCs)
Mouse EpiS cells (mEpiSCs)

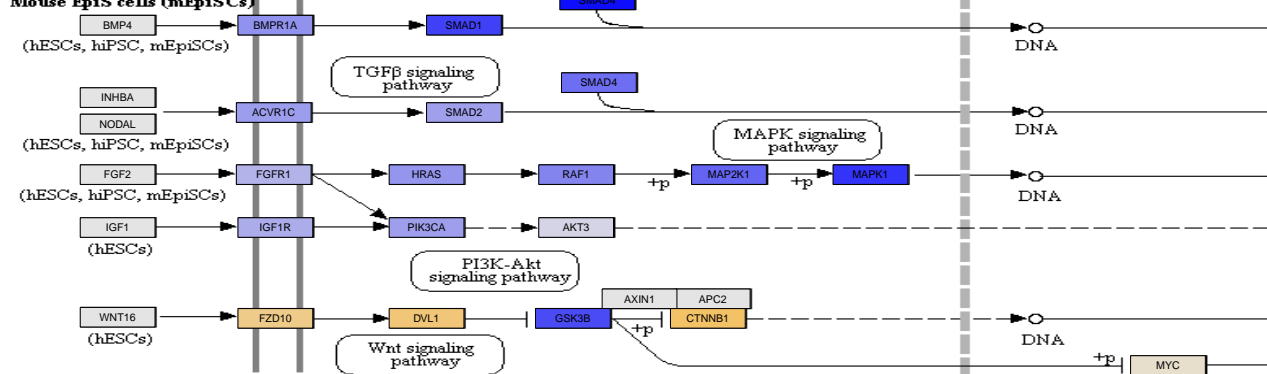

Core transcriptional network

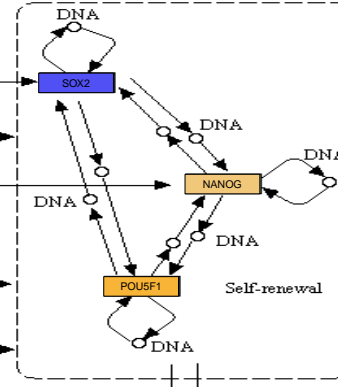

OCT4, SOX2, and NANOG target genes in human and/or mouse ES cells

- Key pluripotency genes: POU5F1, SOX2, NANOG
- ES cell transcription factors: STAT3, HESX1, ZIC3, ESRRB
- ES cell signaling: TCF3, FGF2, LEFTY2, SKIL
- Epigenetic regulators: SMARCA1, KAT6A, SETDB1, JARID2
- Inhibitor of neurogenesis: REST
- Telomere-associated protein: RIF1
- Pluripotency maintenance: COMMD3-BMI1
- Ectoderm development: PAX6, MEIS1, HOXB1, LHX5, OTX1, NEUROG1
- Mesoderm development: HAND1, DLX5, MYF5, ONECUT1
- Endoderm development: ISL1, ZFH3
- Extra-embryonic development: ESX1

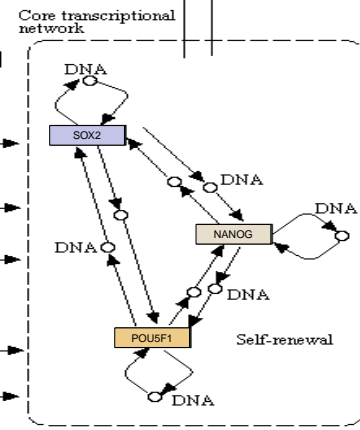

Naive stem cells

Mouse ES cells (mESCs)
Mouse iPSCs (miPSCs)

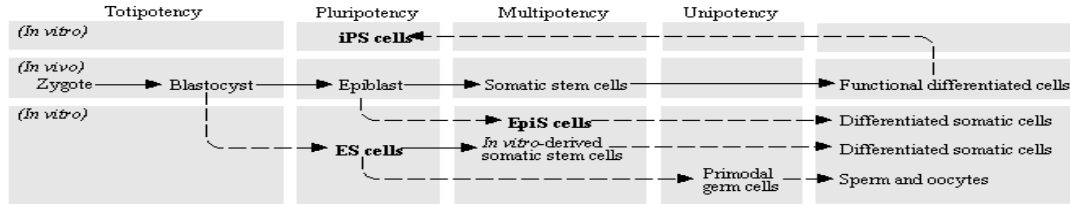
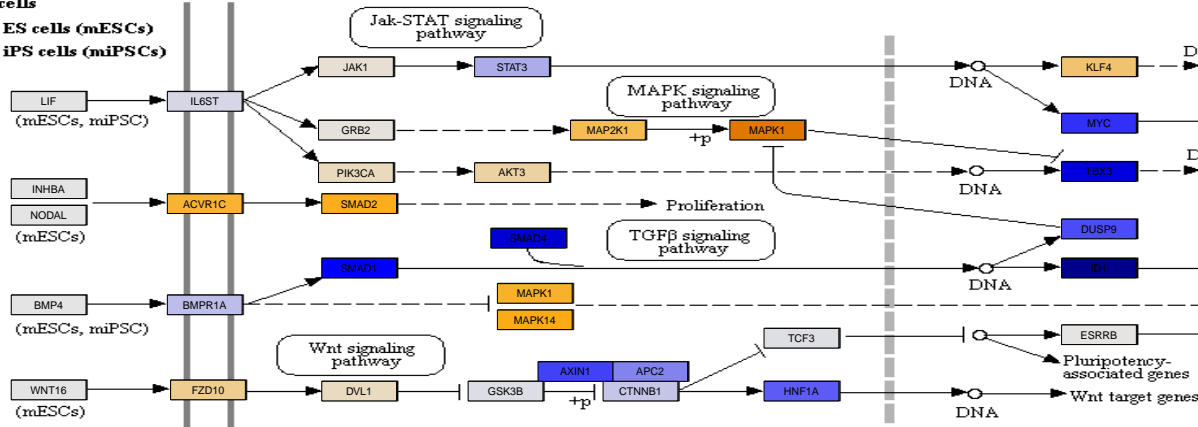

Primed stem cells

Human ES cells (hESCs)
Human iPSCs (hiPSCs)
Mouse EpiS cells (mEpiSCs)

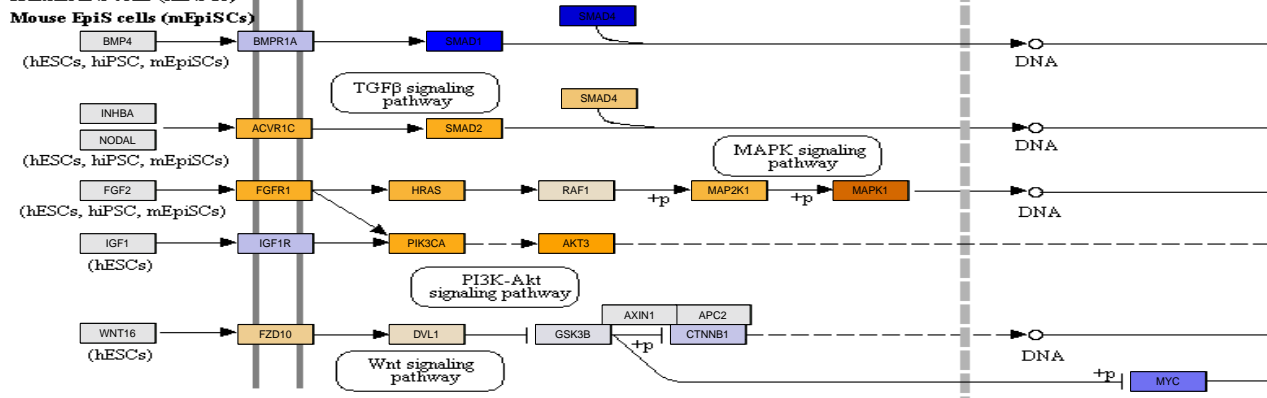

Core transcriptional network

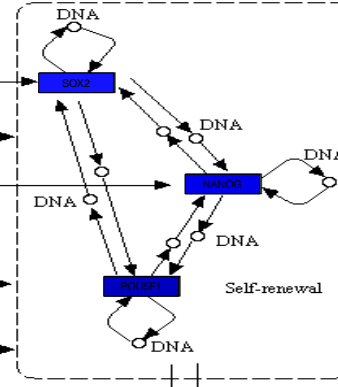

OCT4, SOX2, and NANOG target genes in human and/or mouse ES cells

- Key pluripotency genes**
 - POU5F1, SOX2, NANOG
- ES cell transcription factors**
 - STAT3, HESX1
 - ZIC3, ESRRB
- ES cell signaling**
 - TCF3, FGF2
 - LEFTY2, SKIL
- Epigenetic regulators**
 - SMARCA4, KAT6A
 - SETDB1, JARID2
- Inhibitor of neurogenesis**
 - REST
- Telomere-associated protein**
 - RIF1
- Pluripotency maintenance**
 - COMMD3-BM1
- Ectoderm development**
 - PAX6, MEIS1, HOXB1
 - LHX5, OTX1, NEUROG1
- Mesoderm development**
 - HAND1, DLX5
 - MYF5, ONECUT1
- Endoderm development**
 - ISL1, ZFH3
- Extra-embryonic development**
 - ESX1

Core transcriptional network

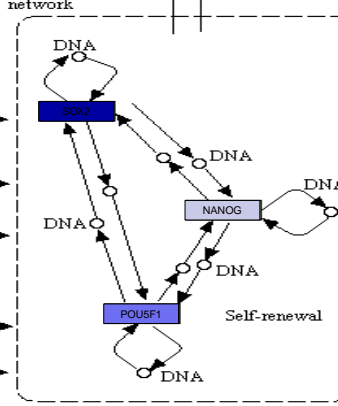

Naive stem cells

Mouse ES cells (mESCs)
Mouse iPSCs (miPSCs)

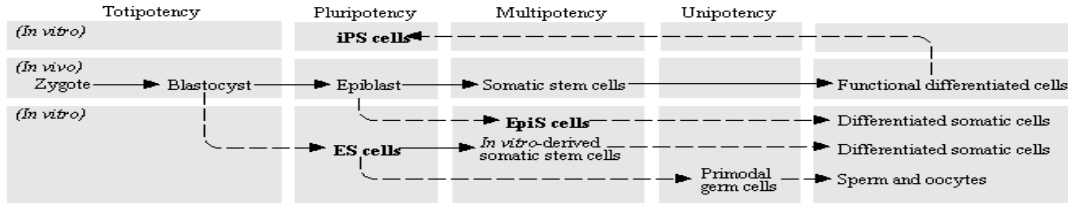
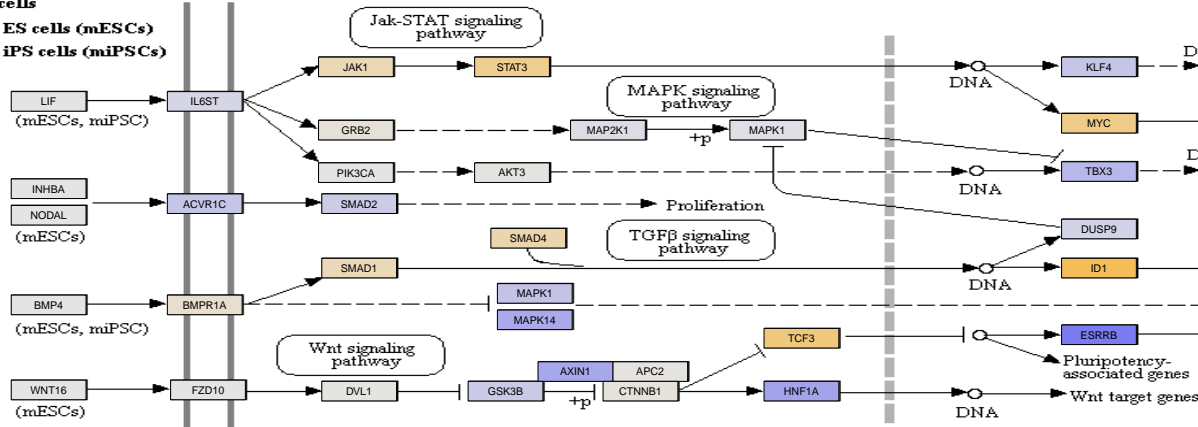

Primed stem cells

Human ES cells (hESCs)
Human iPSCs (hiPSCs)
Mouse EpiS cells (mEpiSCs)

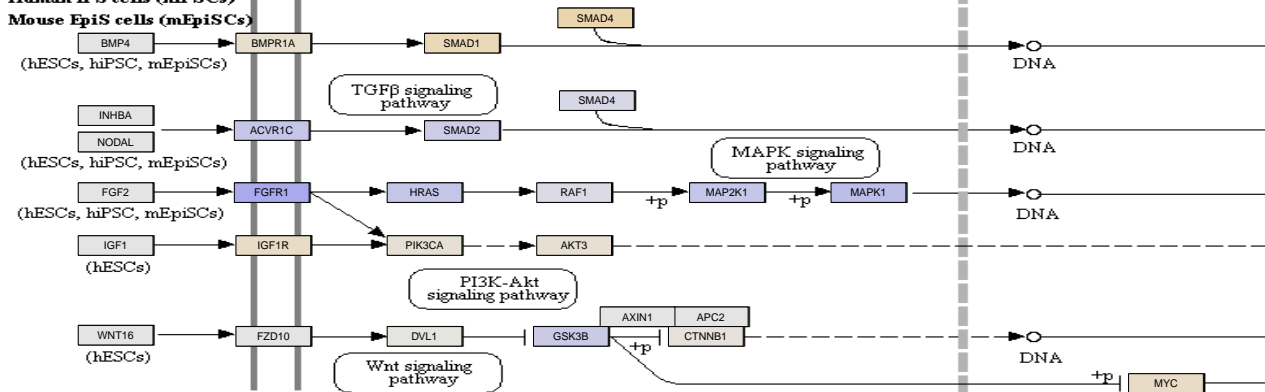

Core transcriptional network

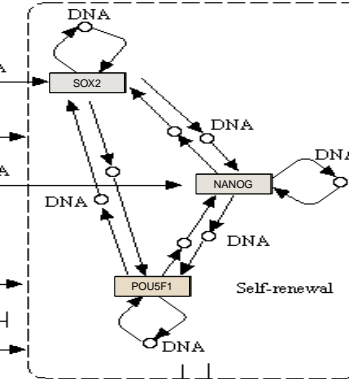

OCT4, SOX2, and NANOG target genes in human and/or mouse ES cells

- Key pluripotency genes**
 - POU5F1, SOX2, NANOG
- ES cell transcription factors**
 - STAT3, HESX1, ZIC3, ESRRB
- ES cell signaling**
 - TCF3, FGF2, LEFTY2, SKIL
- Epigenetic regulators**
 - SMARCA4, KAT6A, SETDB1, JARID2
- Inhibitor of neurogenesis**
 - REST
- Telomere-associated protein**
 - RIF1
- Pluripotency maintenance**
 - COMMD3-BM1
- Ectoderm development**
 - PAX6, MEIS1, HOXB1, LHX5, OTX1, NEUROG1
- Mesoderm development**
 - HAND1, DLX5, MYF5, ONECUT1
- Endoderm development**
 - ISL1, ZFH3
- Extra-embryonic development**
 - ESX1

Signaling_pathways_regulating_pluripotency_of_stem_cells
group 5

Naive stem cells

Mouse ES cells (mESCs)
Mouse iPSCs (miPSCs)

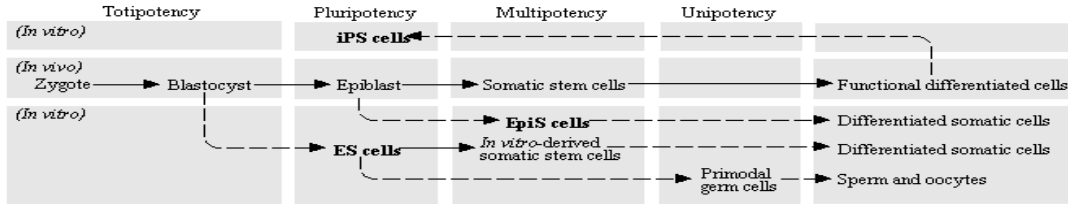
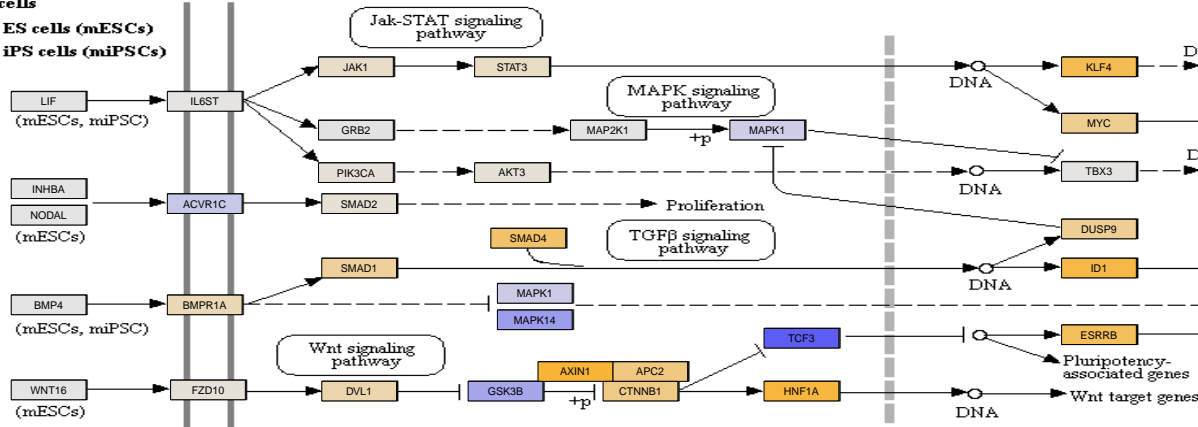

Primed stem cells

Human ES cells (hESCs)
Human iPSCs (hiPSCs)
Mouse EpiS cells (mEpiSCs)

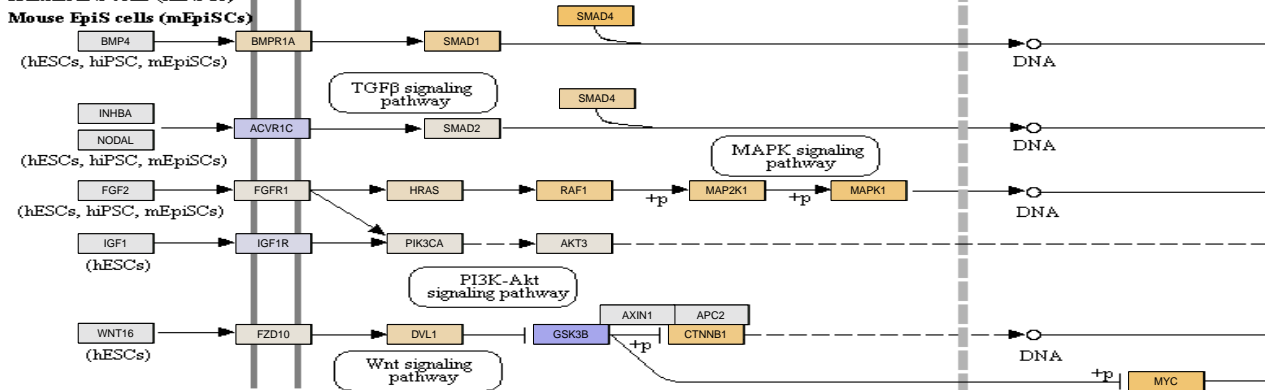

Core transcriptional network

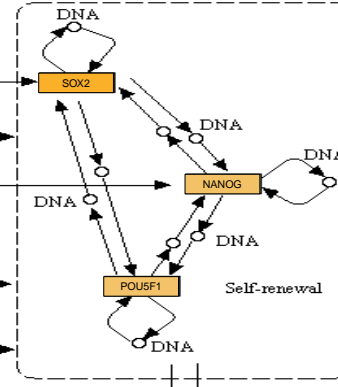

OCT4, SOX2, and NANOG target genes in human and/or mouse ES cells

- Key pluripotency genes: POU5F1, SOX2, NANOG
- ES cell transcription factors: STAT3, HESX1, ZIC3, ESRRB
- ES cell signaling: TCF3, FGF2, LEFTY2, SKIL
- Epigenetic regulators: SMARCA1, KAT6A, SETDB1, JARID2
- Inhibitor of neurogenesis: REST
- Telomere-associated protein: RIF1
- Pluripotency maintenance: COMMD3-BMI1
- Ectoderm development: PAX6, MEIS1, HOXB1, LHX5, OTX1, NEUROG1
- Mesoderm development: HAND1, DLX5, MYF5, ONECUT1
- Endoderm development: ISL1, ZFH3
- Extra-embryonic development: ESX1

Core transcriptional network

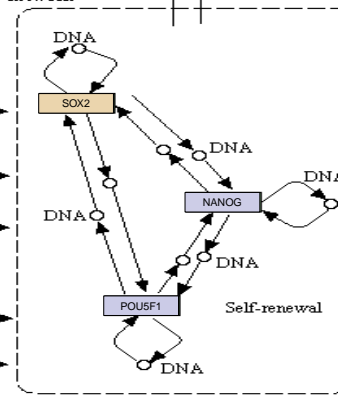

Naive stem cells

Mouse ES cells (mESCs)
Mouse iPSCs (miPSCs)

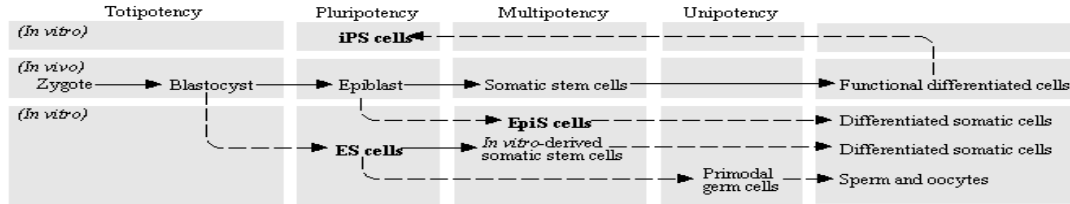
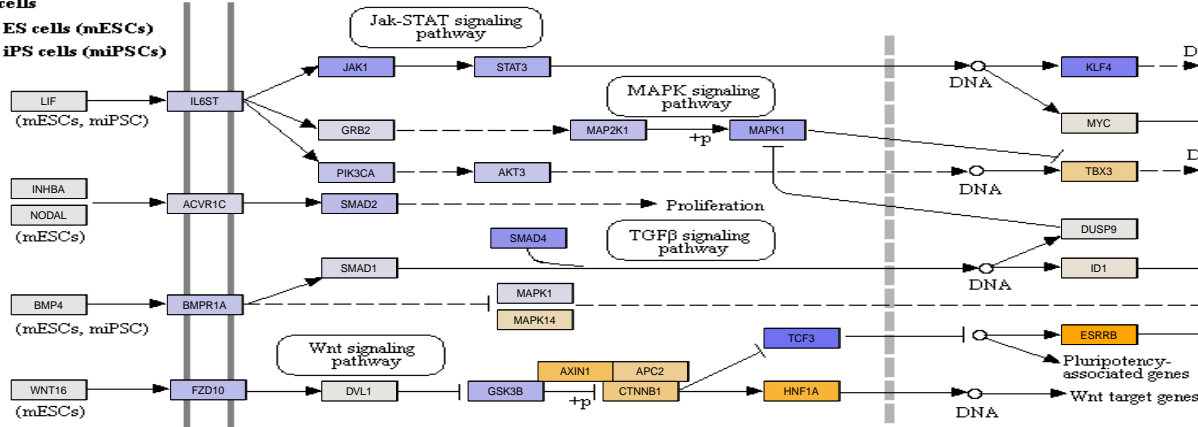

Primed stem cells

Human ES cells (hESCs)
Human iPSCs (hiPSCs)
Mouse EpiS cells (mEpiSCs)

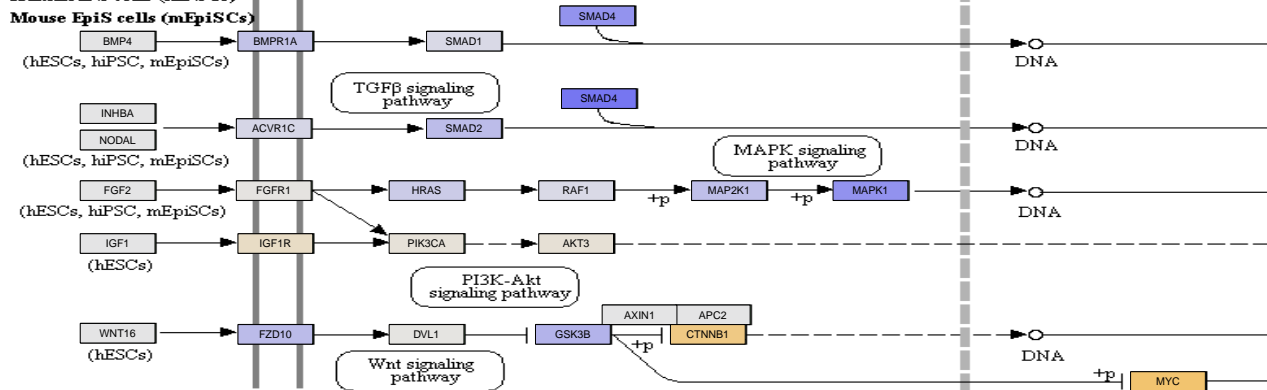

Core transcriptional network

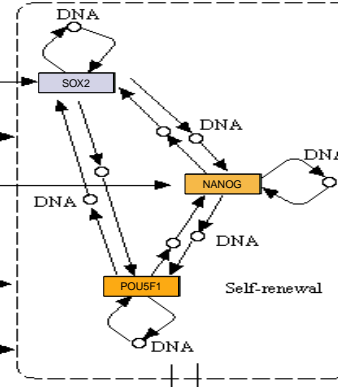

OCT4, SOX2, and NANOG target genes in human and/or mouse ES cells

- Key pluripotency genes**
 - POU5F1, SOX2, NANOG
- ES cell transcription factors**
 - STAT3, HESX1, ZIC3, ESRRB
- ES cell signaling**
 - TCF3, FGF2, LEFTY2, SKIL
- Epigenetic regulators**
 - SMARCA1, KAT6A, SETDB1, JARID2
- Inhibitor of neurogenesis**
 - REST
- Telomere-associated protein**
 - RIF1
- Pluripotency maintenance**
 - COMMD3-BM1
- Ectoderm development**
 - PAX6, MEIS1, HOXB1, LHX5, OTX1, NEUROG1
- Mesoderm development**
 - HAND1, DLX5, MYF5, ONECUT1
- Endoderm development**
 - ISL1, ZFH3
- Extra-embryonic development**
 - ESX1

Naive stem cells

Mouse ES cells (mESCs)
Mouse iPSCs (miPSCs)

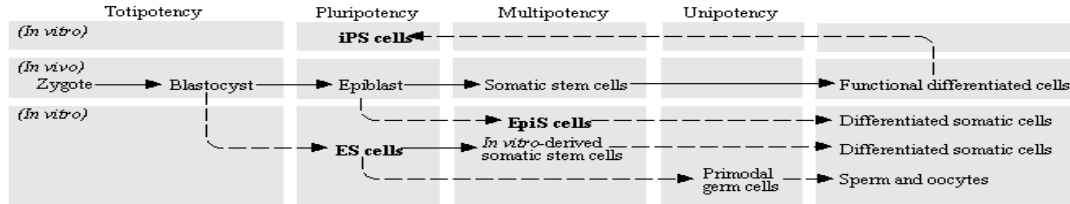
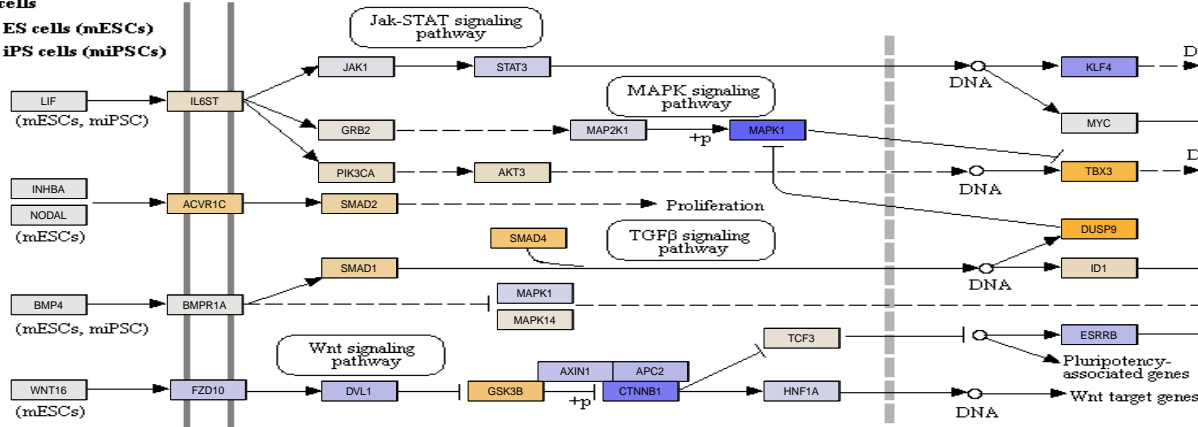

Primed stem cells

Human ES cells (hESCs)
Human iPSCs (hiPSCs)
Mouse EpiS cells (mEpiSCs)

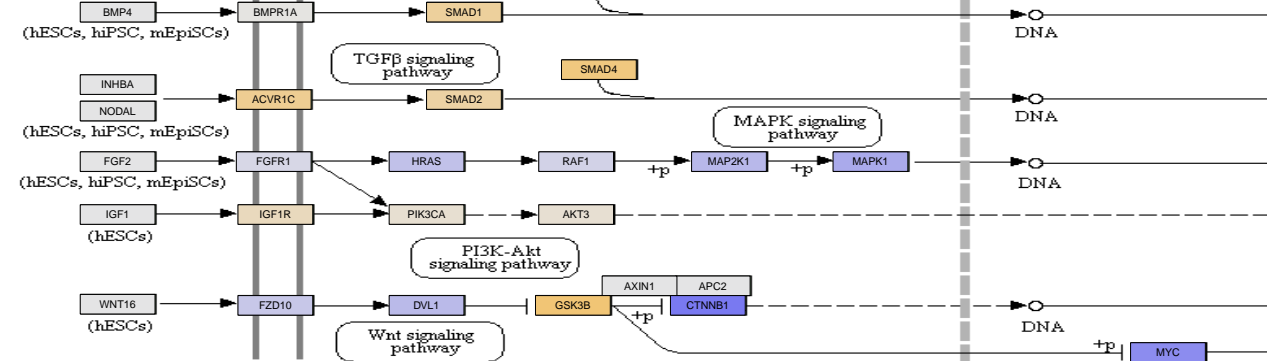

Core transcriptional network

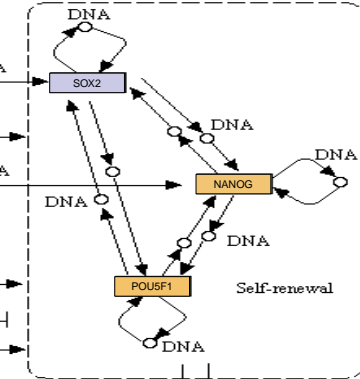

OCT4, SOX2, and NANOG target genes in human and/or mouse ES cells

- Key pluripotency genes**
 - POU5F1, SOX2, NANOG
- ES cell transcription factors**
 - STAT3, HESX1, ZIC3, ESRRB
- ES cell signaling**
 - TCF3, FGF2, LEFTY2, SKIL
- Epigenetic regulators**
 - SMARCA4, KAT6A, SETDB1, JARID2
- Inhibitor of neurogenesis**
 - REST
- Telomere-associated protein**
 - RIF1
- Pluripotency maintenance**
 - COMMD3-BMI1
- Ectoderm development**
 - PAX6, MEIS1, HOXB1, LHX5, OTX1, NEUROG1
- Mesoderm development**
 - HAND1, DLX5, MYF5, ONECUT1
- Endoderm development**
 - ISL1, ZFH3
- Extra-embryonic development**
 - ESX1

Signaling_pathways_regulating_pluripotency_of_stem_cells
group 8

Naive stem cells

Mouse ES cells (mESCs)
Mouse iPSCs (miPSCs)

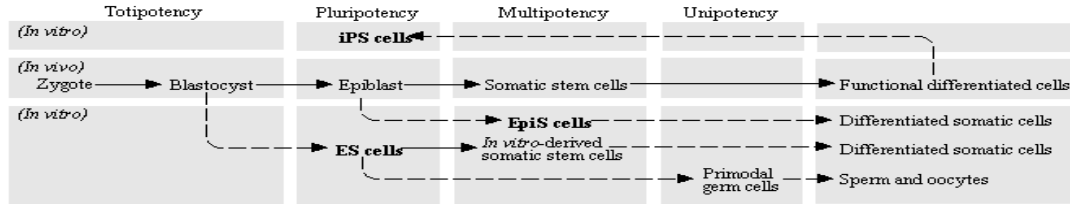
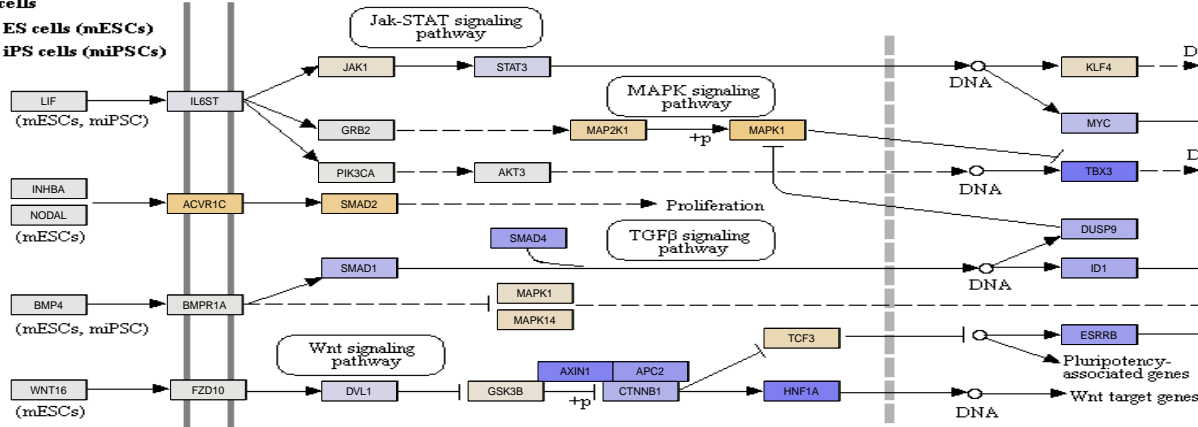

Primed stem cells

Human ES cells (hESCs)
Human iPSCs (hiPSCs)
Mouse EpiS cells (mEpiSCs)

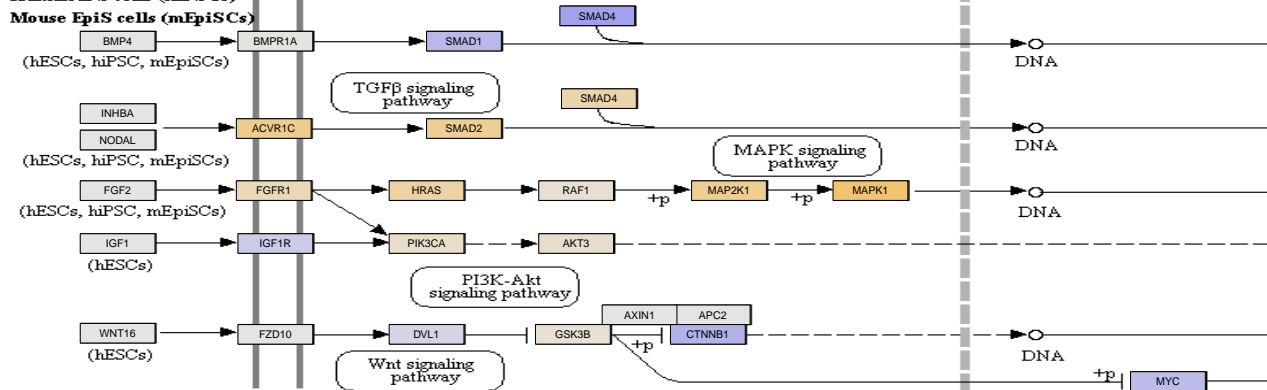

Core transcriptional network

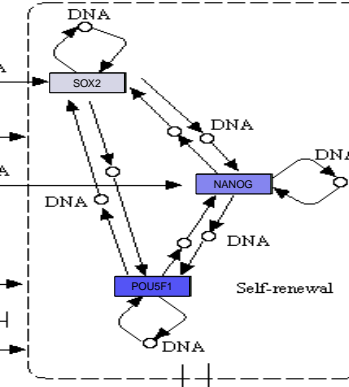

OCT4, SOX2, and NANOG target genes in human and/or mouse ES cells

- Key pluripotency genes: POU5F1, SOX2, NANOG
- ES cell transcription factors: STAT3, HESX1, ZIC3, ESRRB
- ES cell signaling: TCF3, FGF2, LEFTY2, SKIL
- Epigenetic regulators: SMARCA4, KAT6A, SETDB1, JARID2
- Inhibitor of neurogenesis: REST
- Telomere-associated protein: RIF1
- Pluripotency maintenance: COMMD3-BMI1
- Ectoderm development: PAX6, MEIS1, HOXB1, LHX5, OTX1, NEUROG1
- Mesoderm development: HAND1, DLX5, MYF5, ONECUT1
- Endoderm development: ISL1, ZFH3
- Extra-embryonic development: ESX1

