

# Non-small cell lung cancer

## all genes

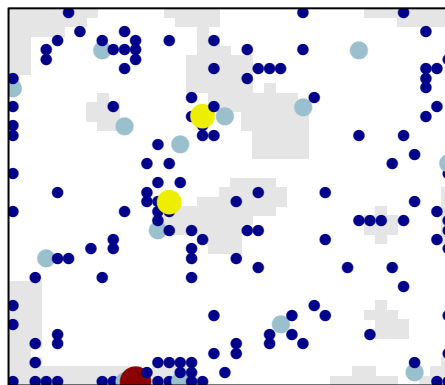

## sink node genes

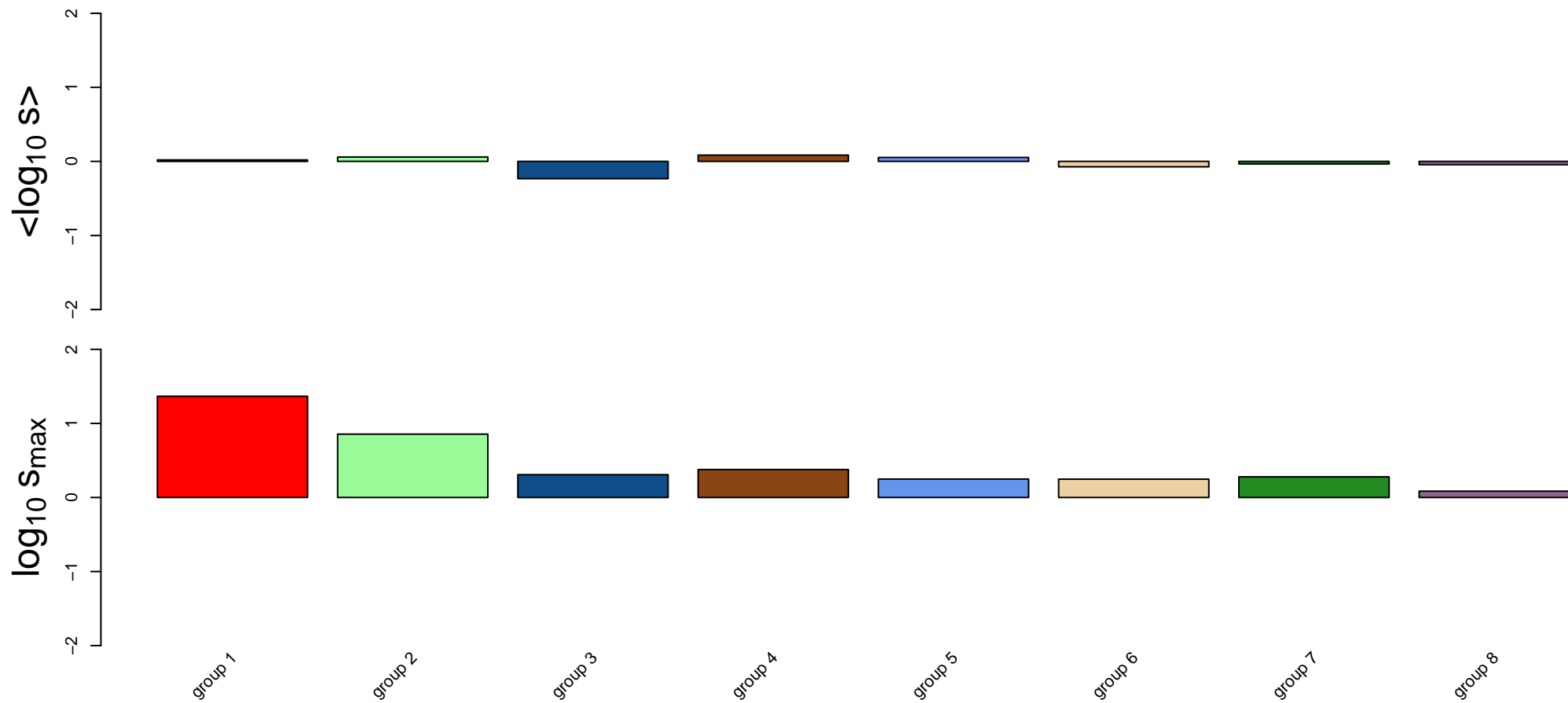
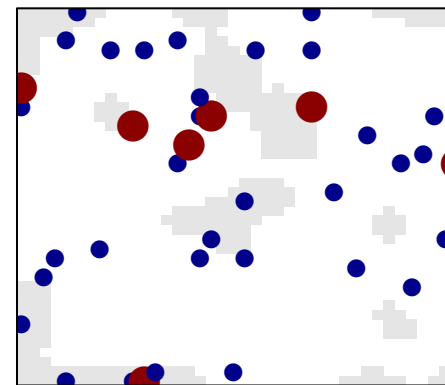

Non\_small\_cell\_lung\_cancer genes with data

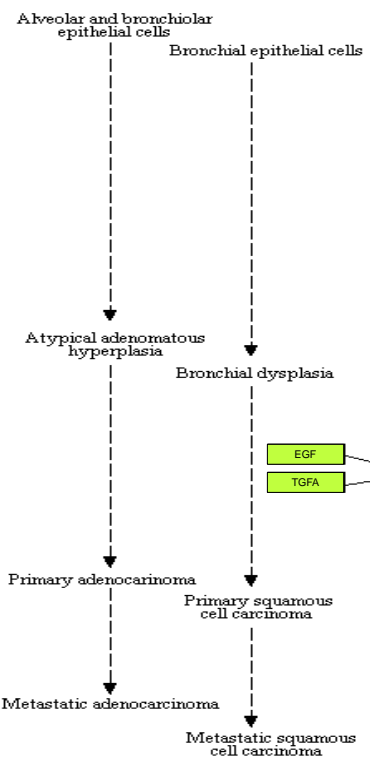

Alveolar and bronchiolar epithelial cell / Bronchial epithelial cell

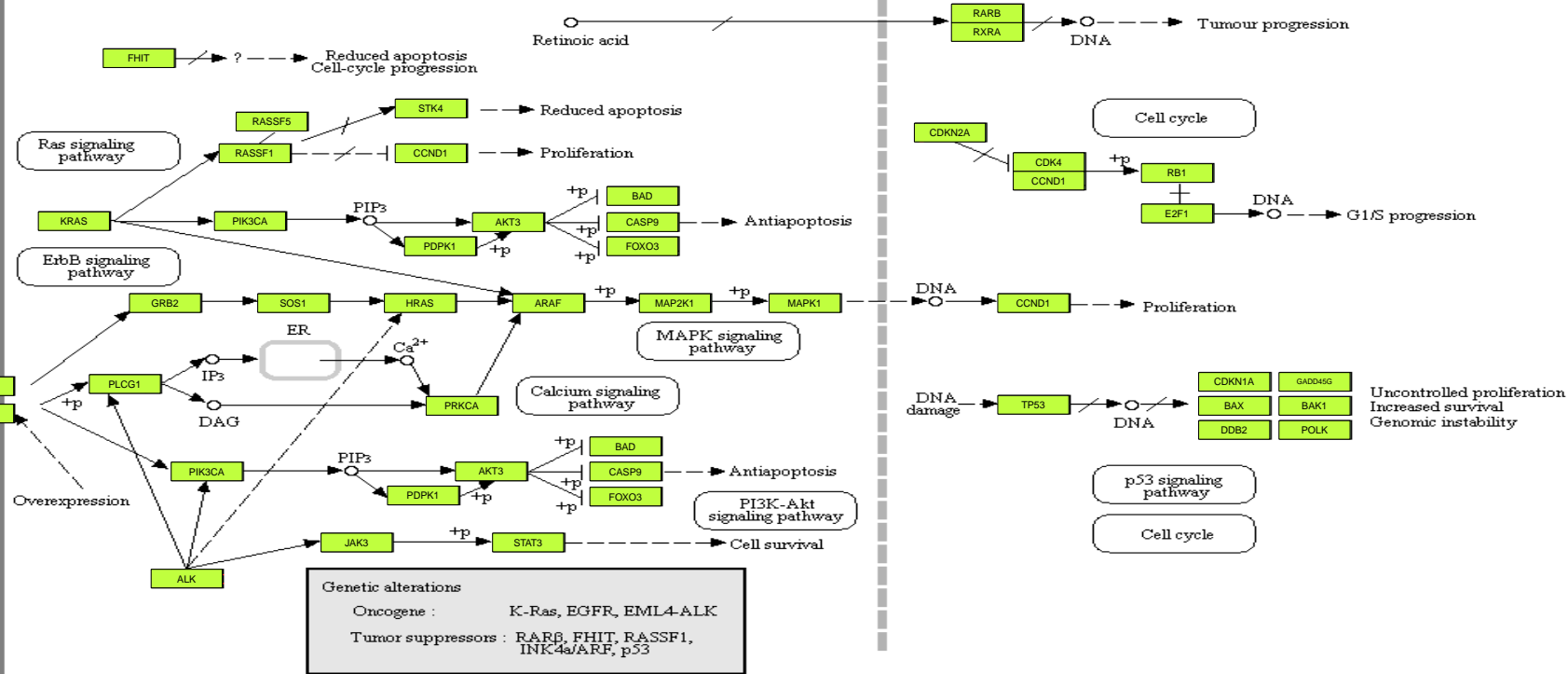

Non\_small\_cell\_lung\_cancer sink nodes

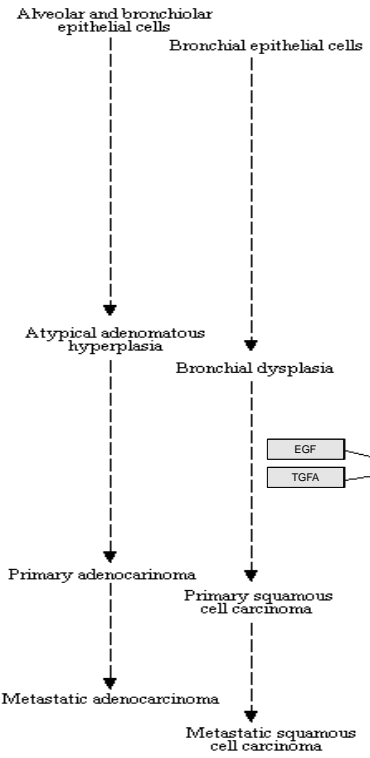

Alveolar and bronchiolar epithelial cell / Bronchial epithelial cell

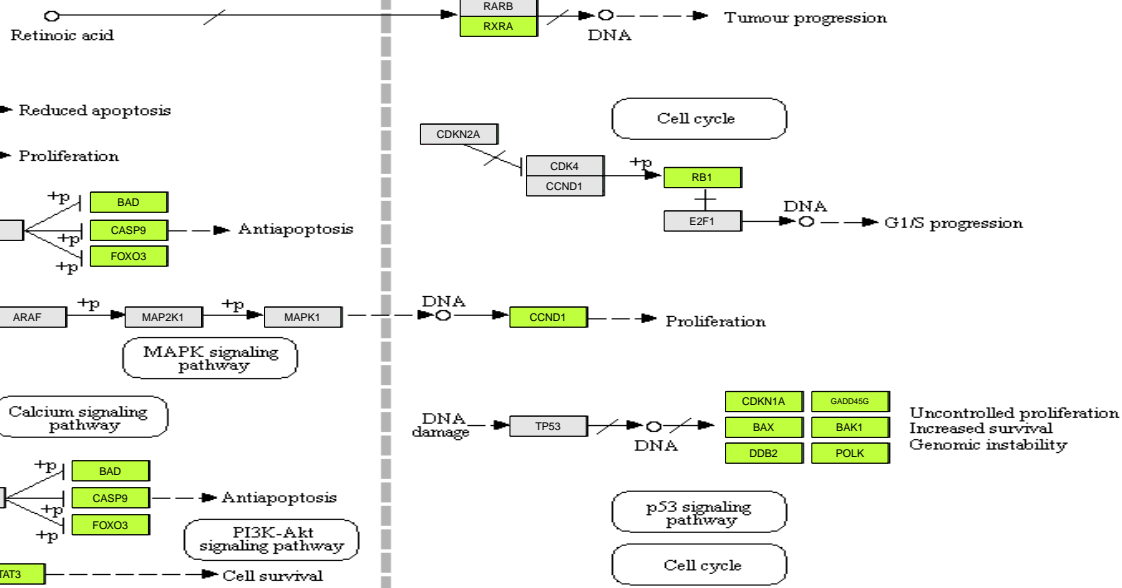
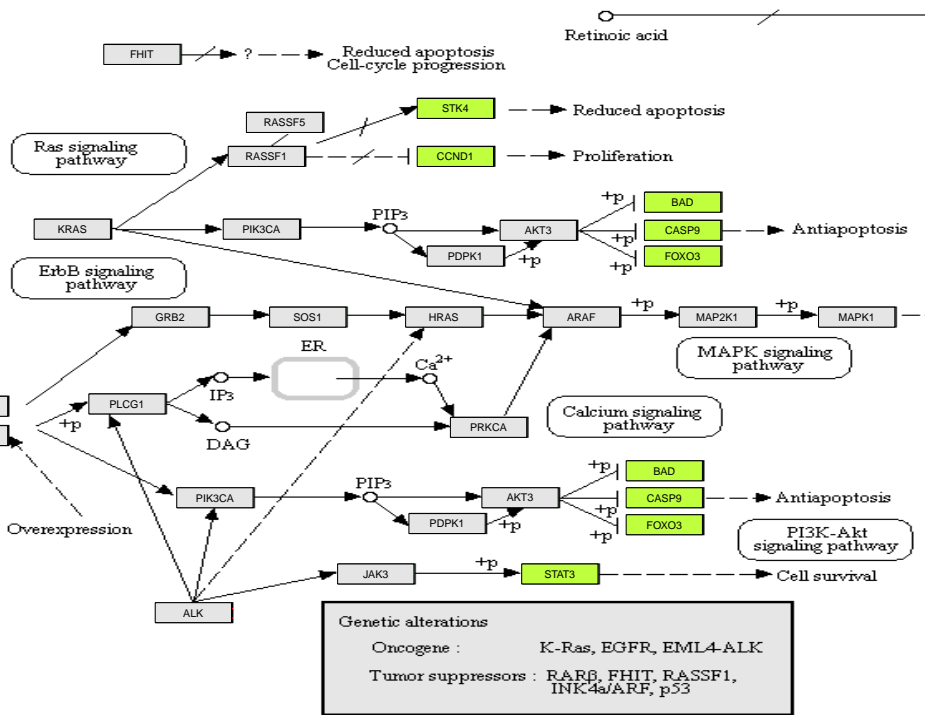

Non\_small\_cell\_lung\_cancer group 1

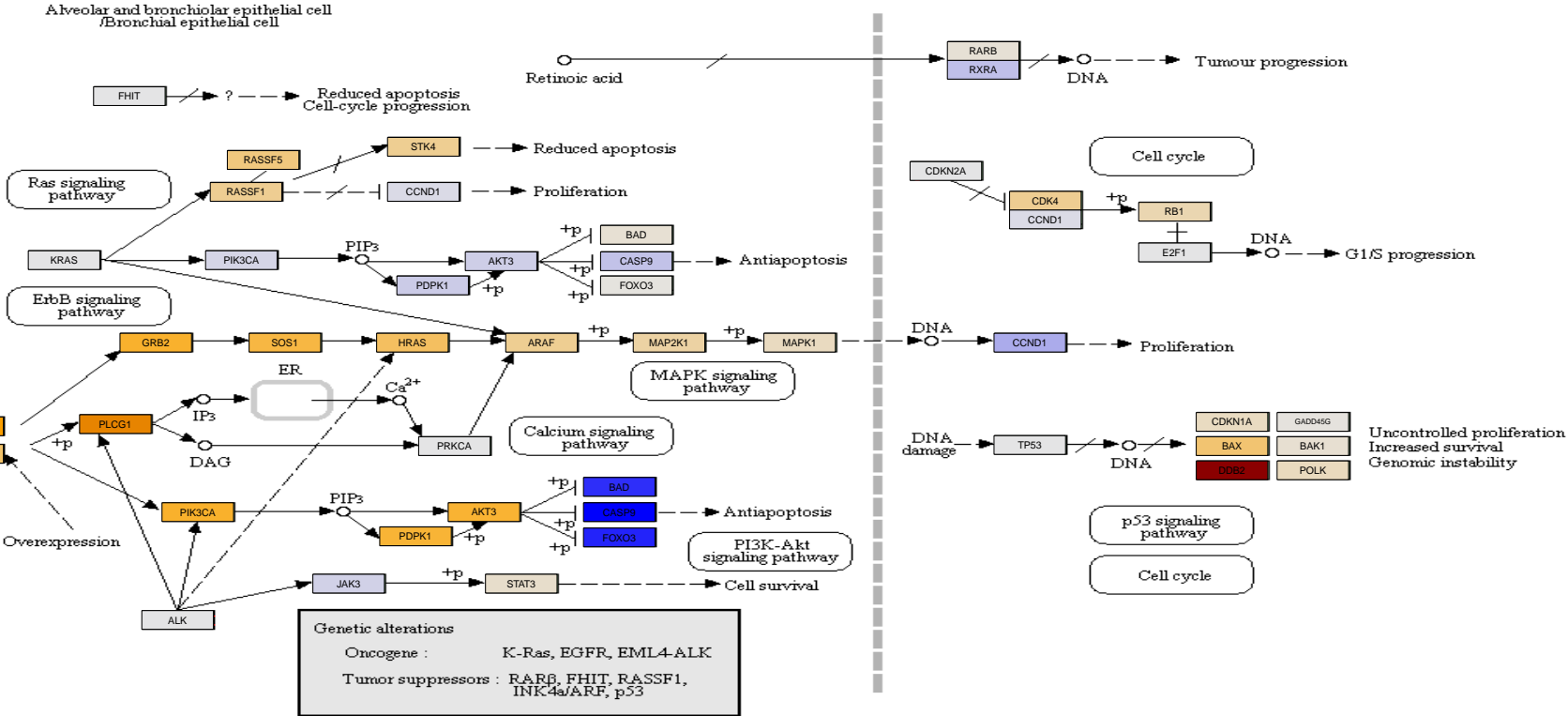
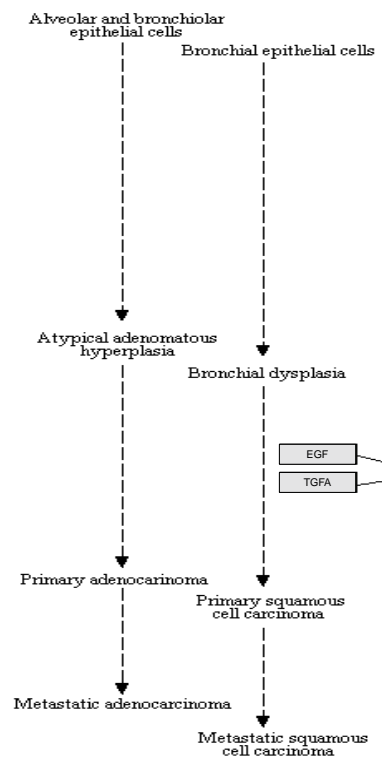

Non\_small\_cell\_lung\_cancer\_group\_2

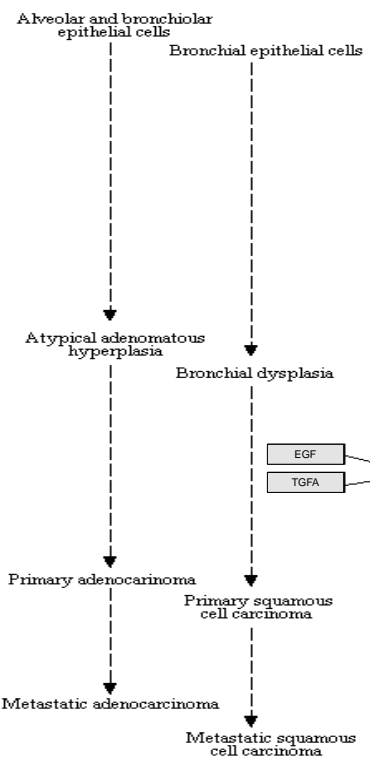

Alveolar and bronchiolar epithelial cell / Bronchial epithelial cell

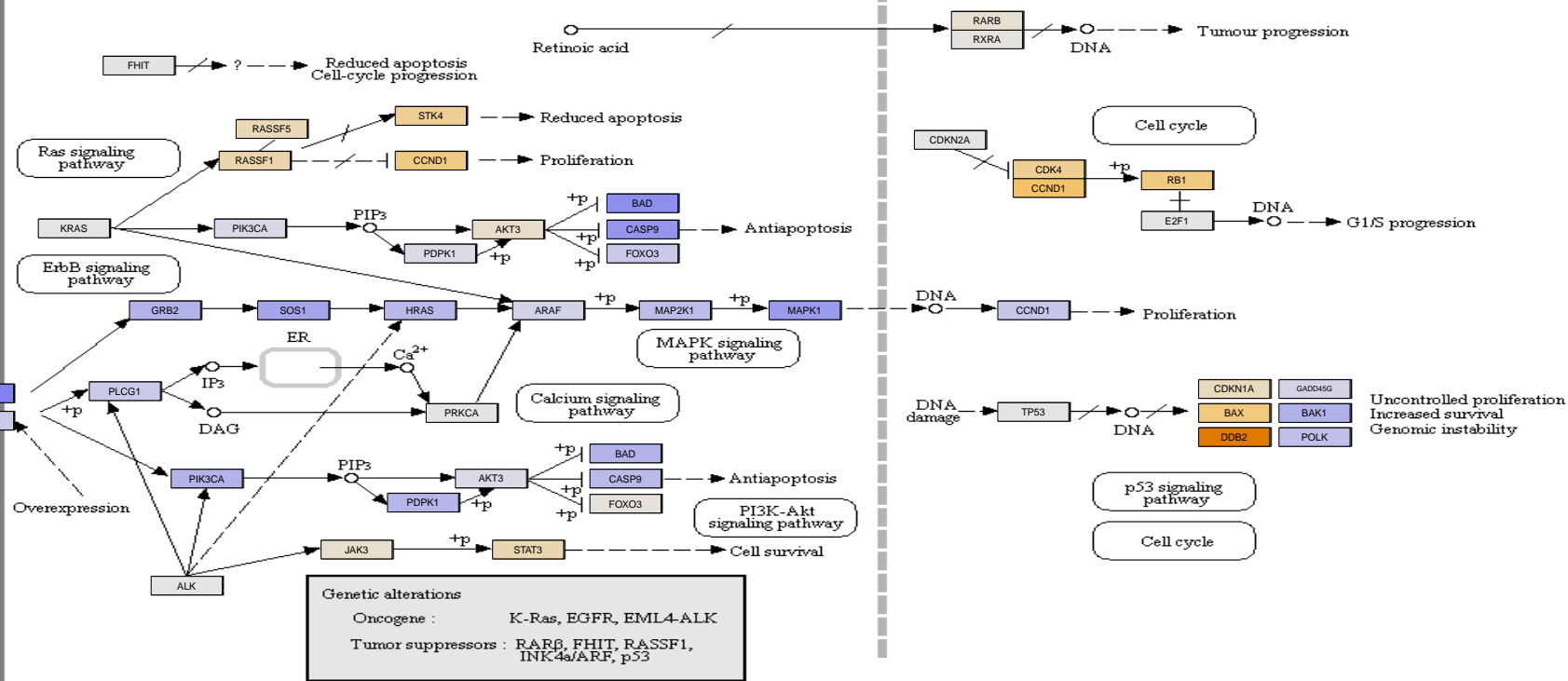

Non\_small\_cell\_lung\_cancer group 3

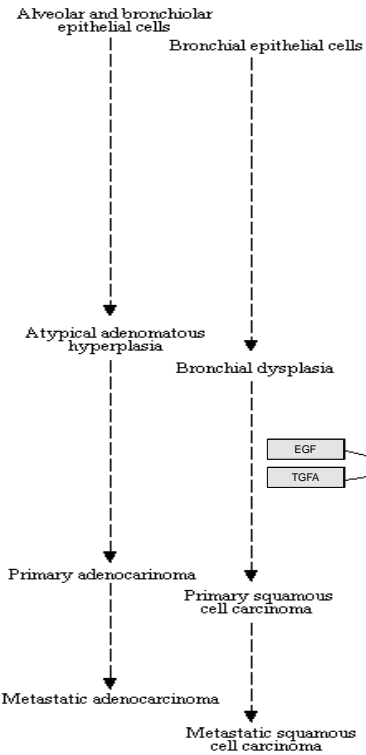

Alveolar and bronchiolar epithelial cell / Bronchial epithelial cell

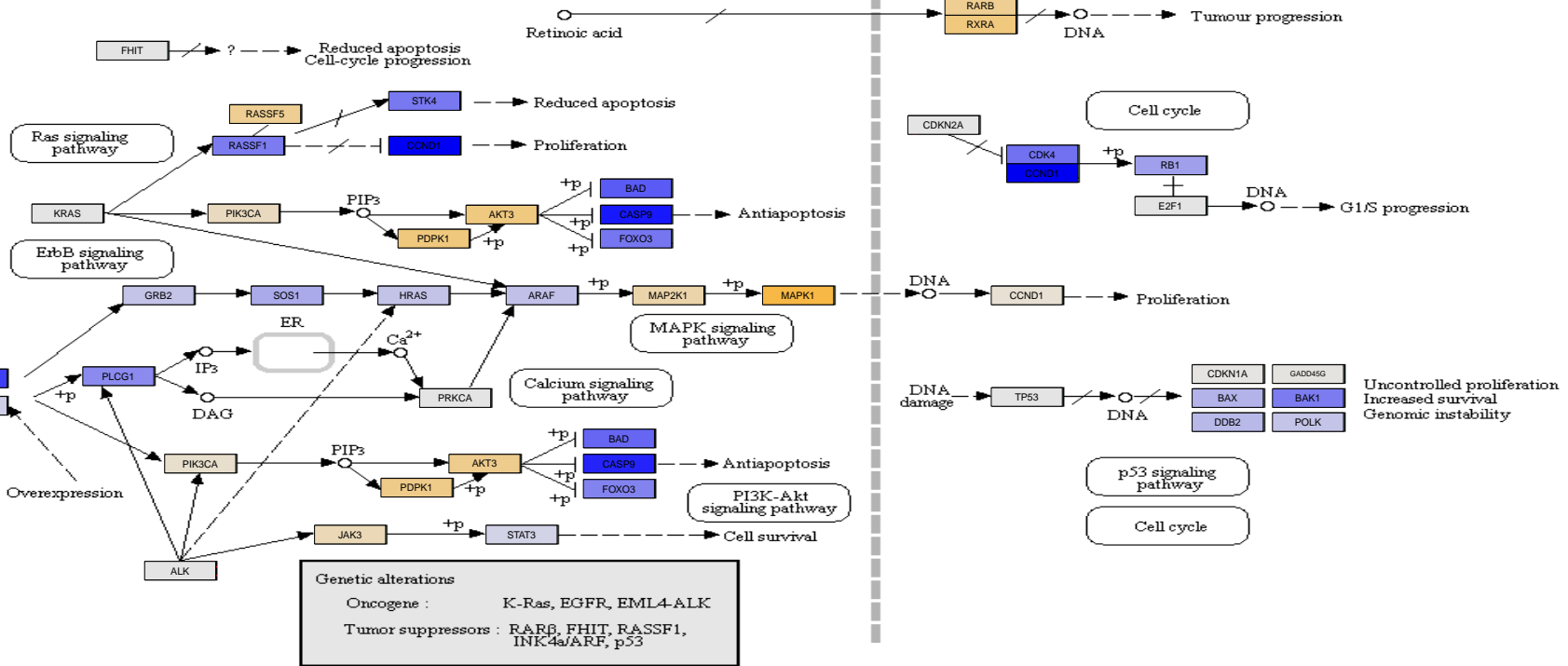

Non\_small\_cell\_lung\_cancer group 4

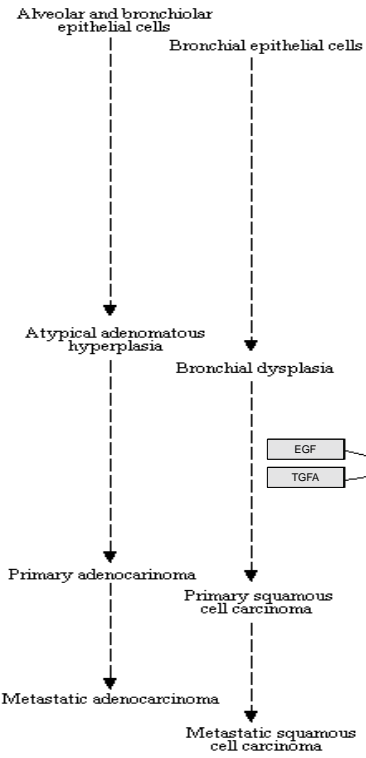

Alveolar and bronchiolar epithelial cell / Bronchial epithelial cell

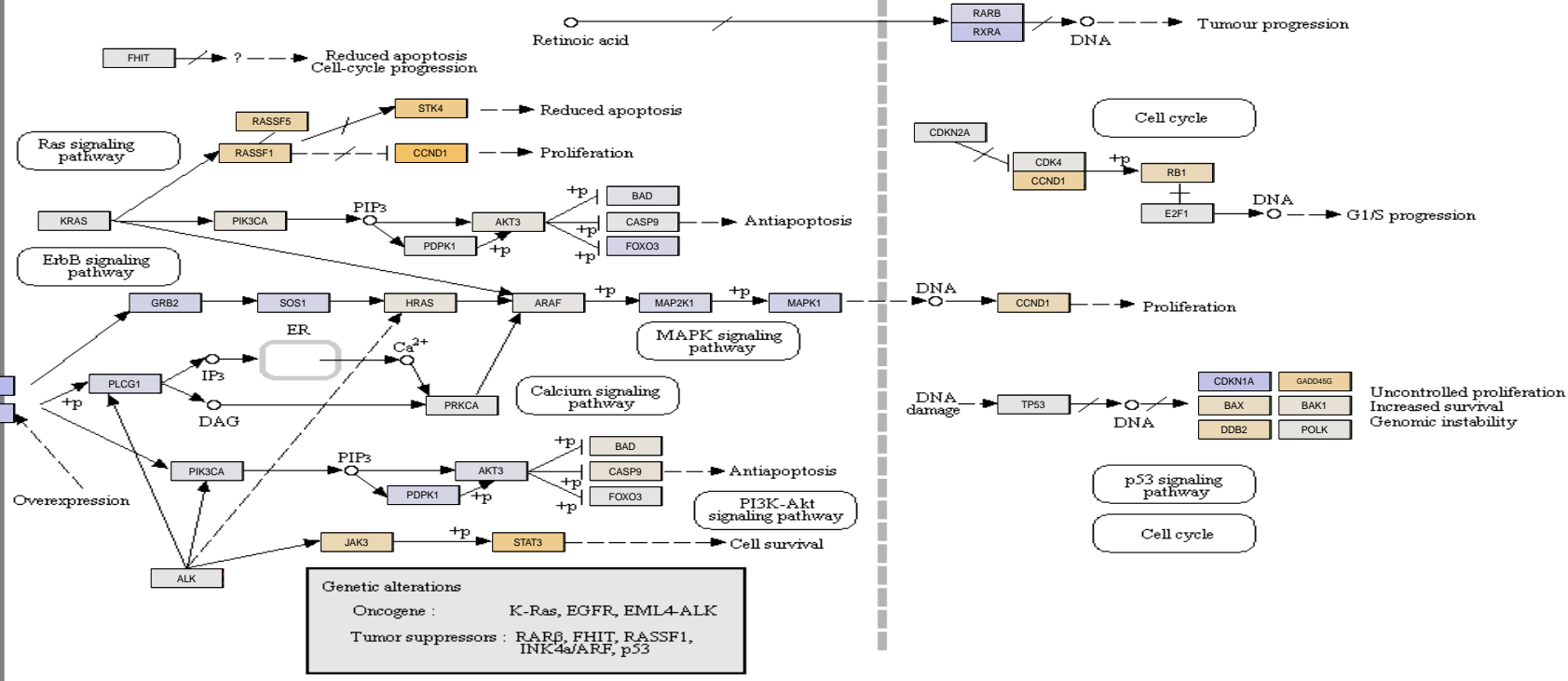

Non\_small\_cell\_lung\_cancer group 5

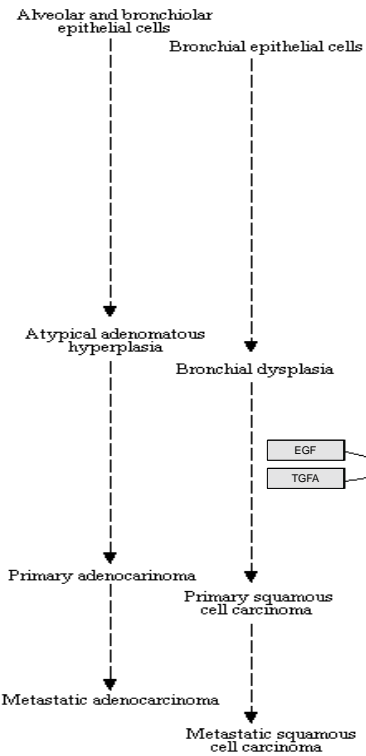

Alveolar and bronchiolar epithelial cell / Bronchial epithelial cell

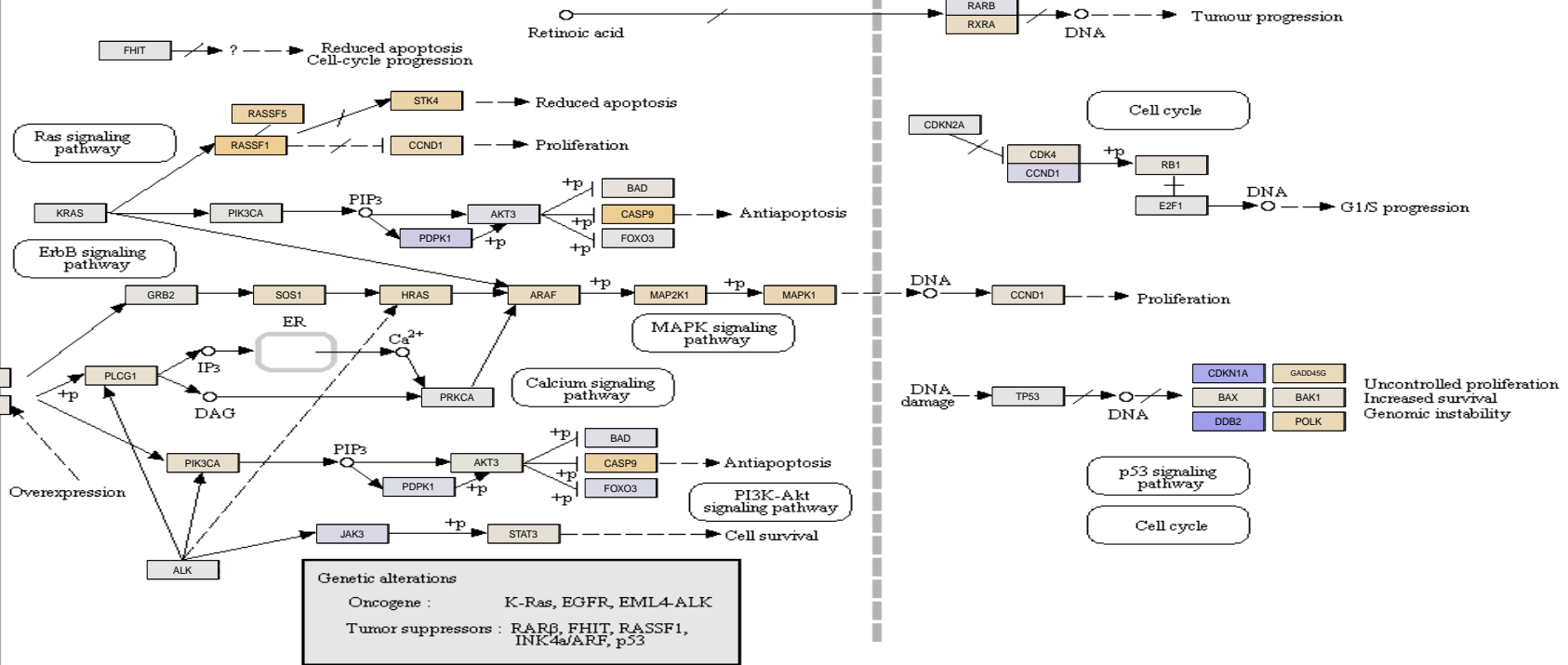



Non\_small\_cell\_lung\_cancer group 6

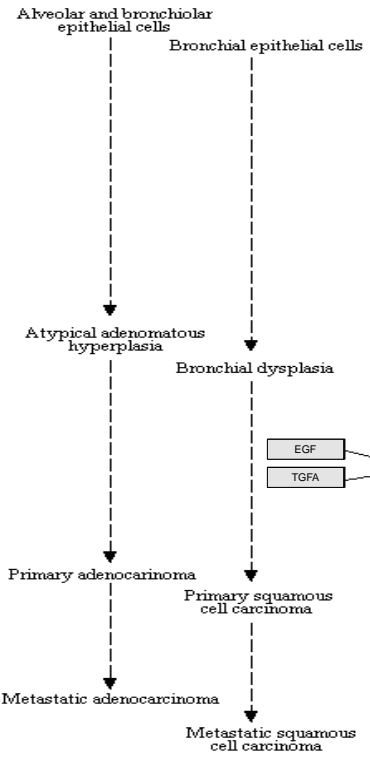

Alveolar and bronchiolar epithelial cell / Bronchial epithelial cell

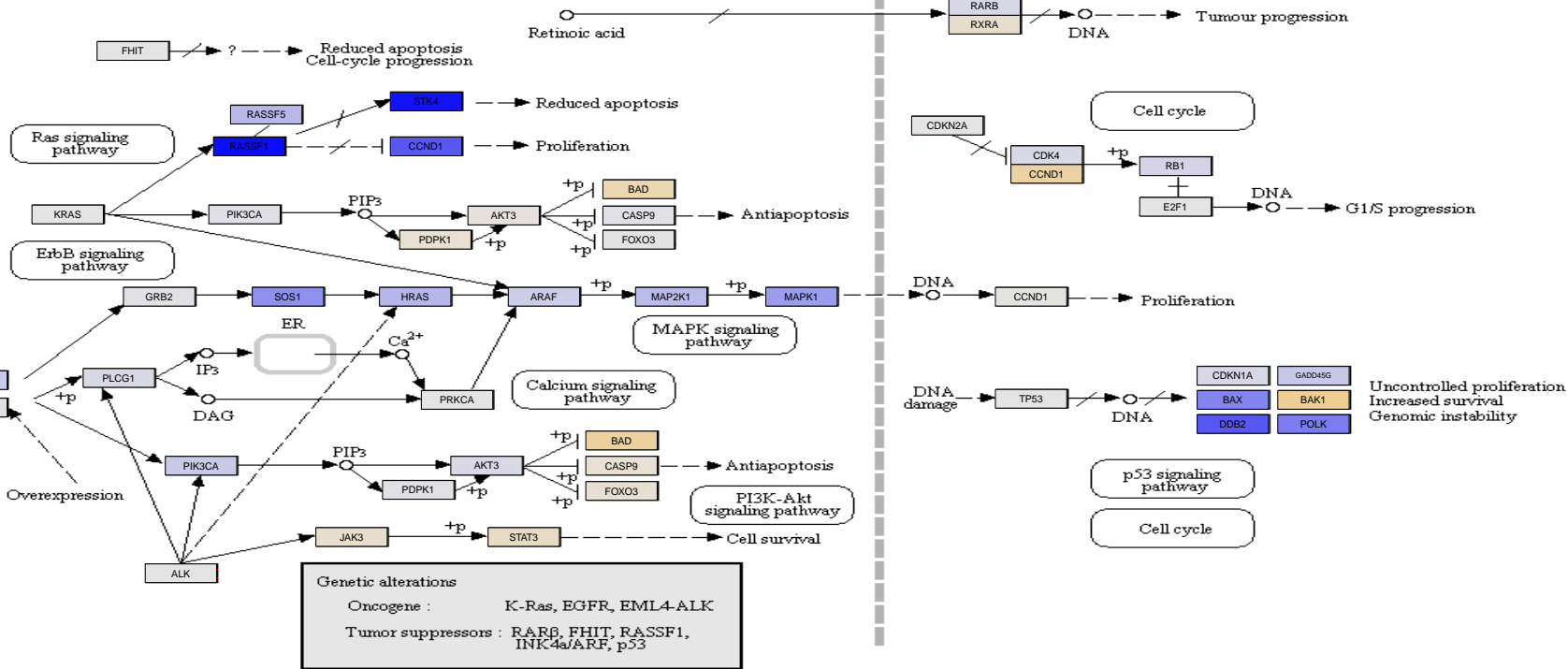

Non\_small\_cell\_lung\_cancer group 7

Alveolar and bronchiolar epithelial cells  
Bronchial epithelial cells

Atypical adenomatous hyperplasia  
Bronchial dysplasia

Primary adenocarcinoma  
Primary squamous cell carcinoma

Metastatic adenocarcinoma  
Metastatic squamous cell carcinoma

Alveolar and bronchiolar epithelial cell / Bronchial epithelial cell

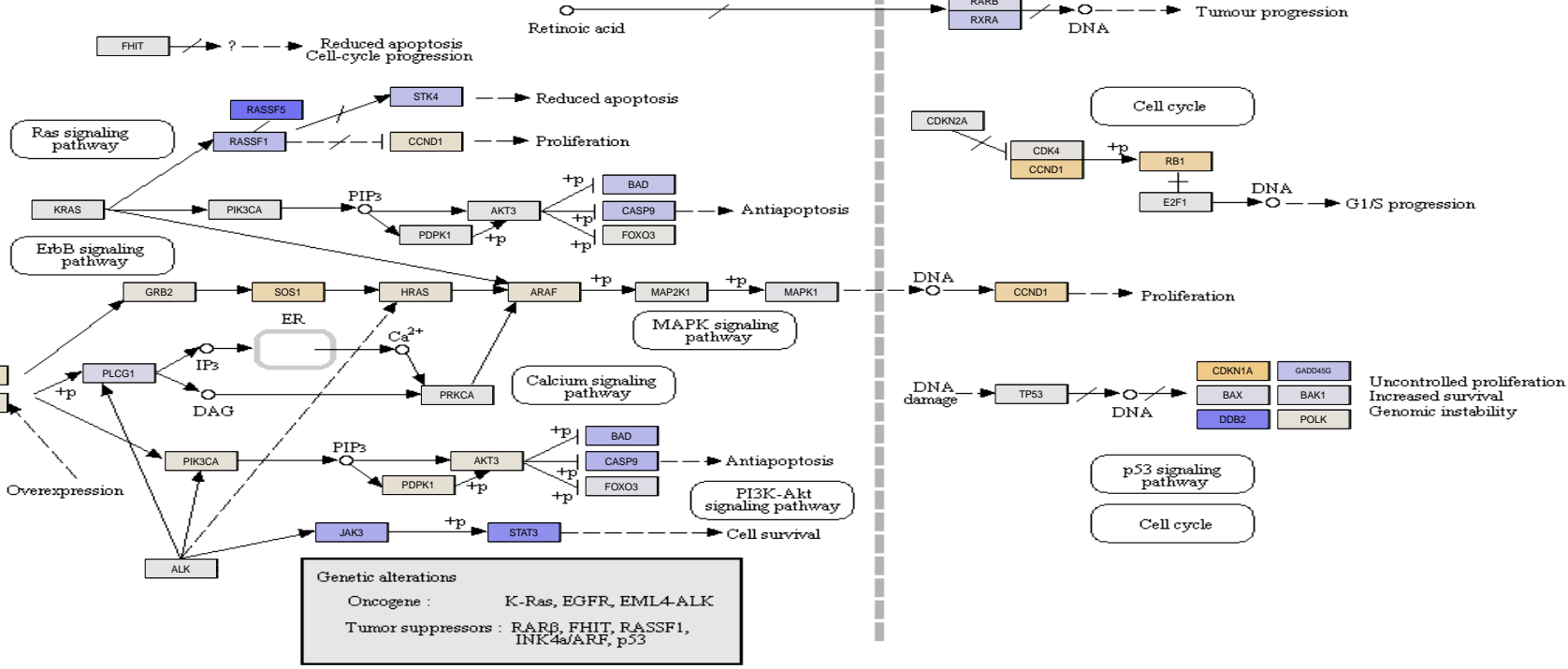

Non\_small\_cell\_lung\_cancer group 8

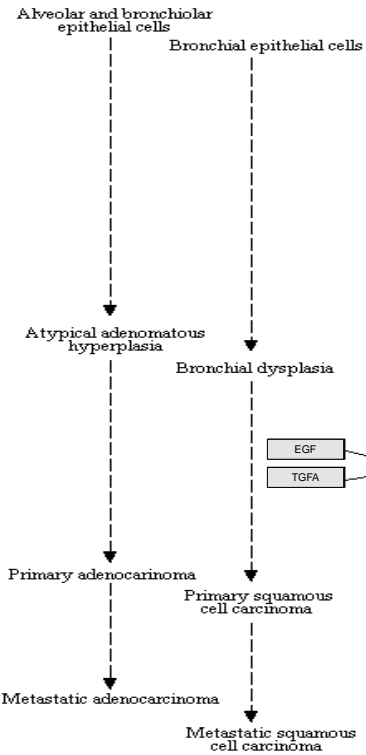

Alveolar and bronchiolar epithelial cell / Bronchial epithelial cell

