

Natural killer cell mediated cytotoxici

all genes

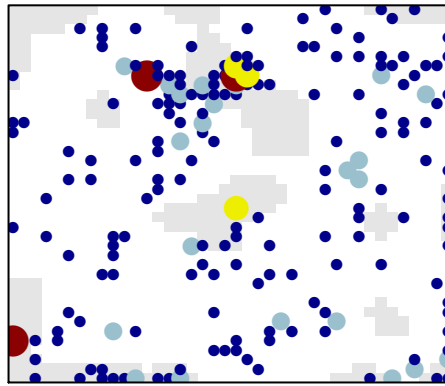

sink node genes

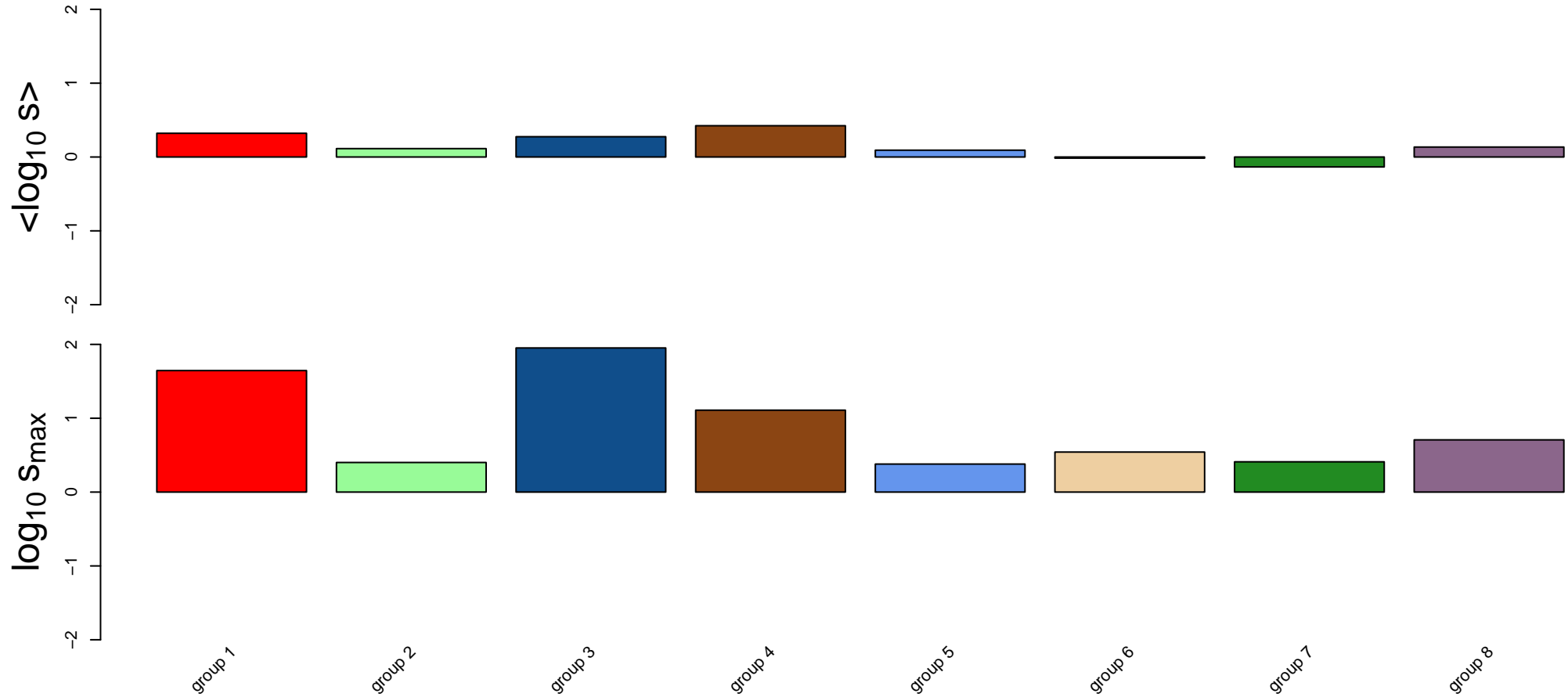
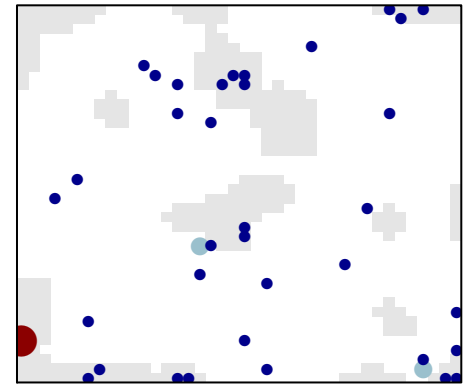

Natural_killer_cell_mediated_cytotoxicity genes with data

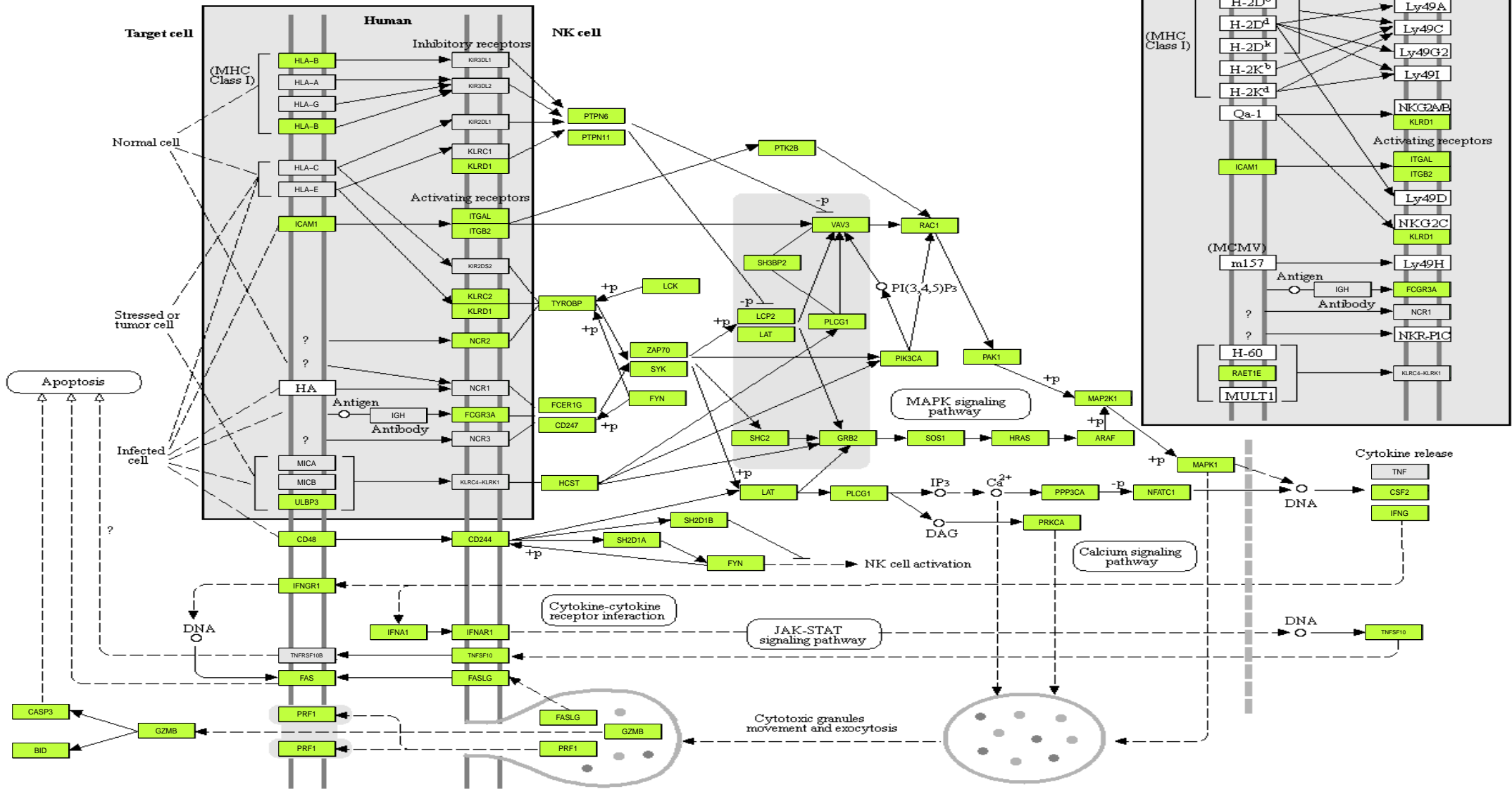

Natural killer cell mediated cytotoxicity sink nodes

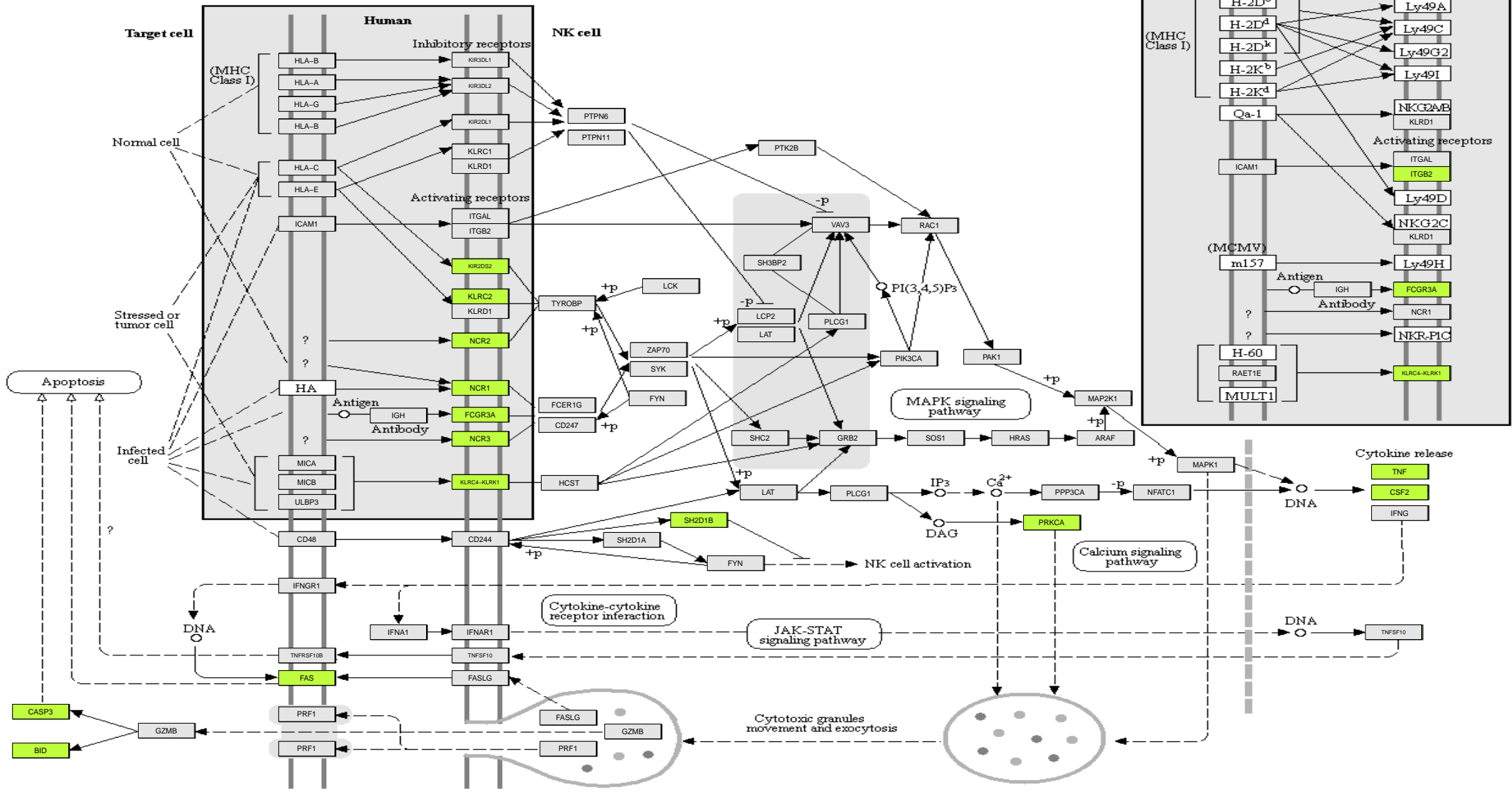

Natural_killer_cell_mediated_cytotoxicity
group 1

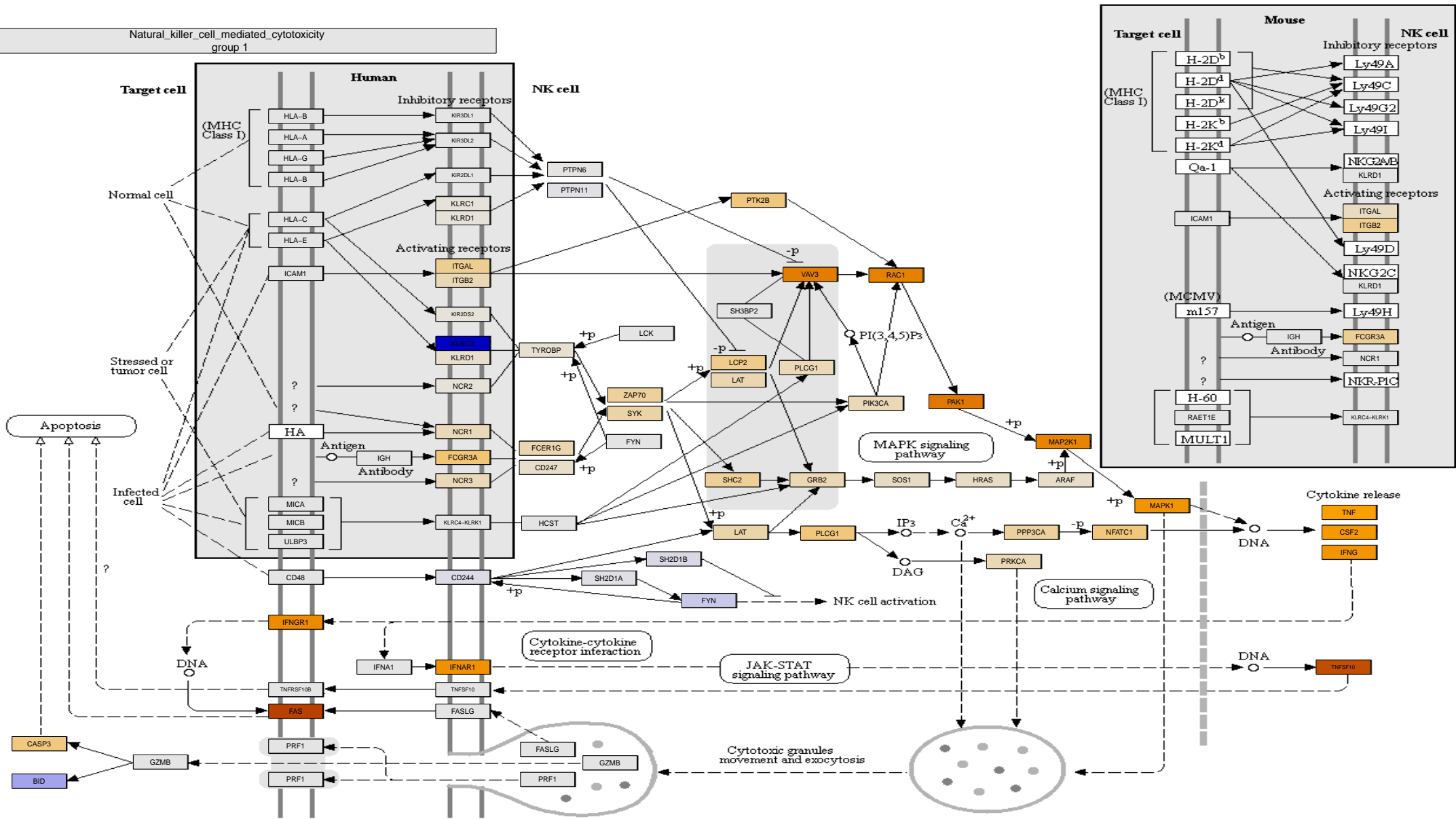

Natural_killer_cell_mediated_cytotoxicity group 2

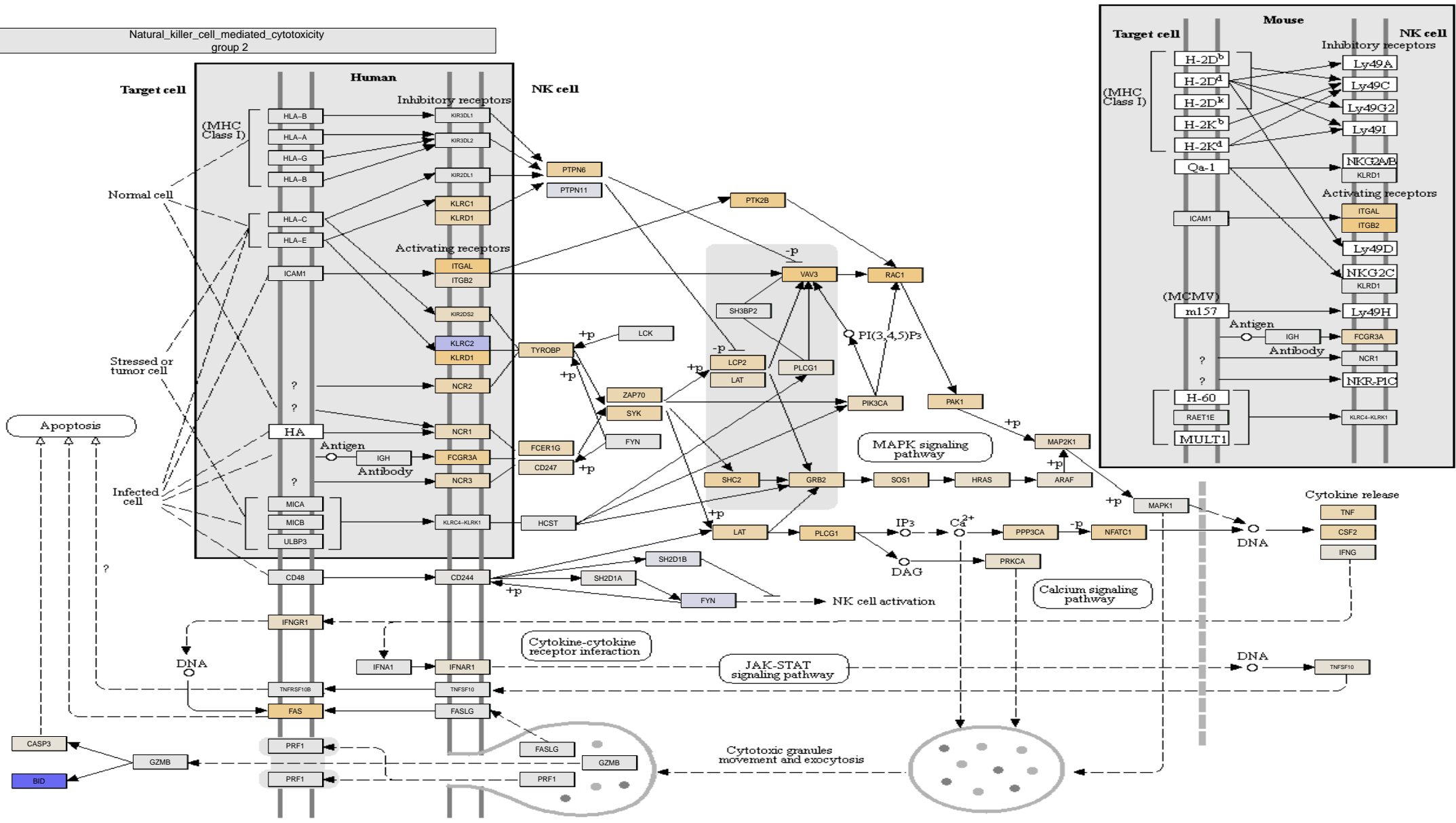

Natural_killer_cell_mediated_cytotoxicity
group 3

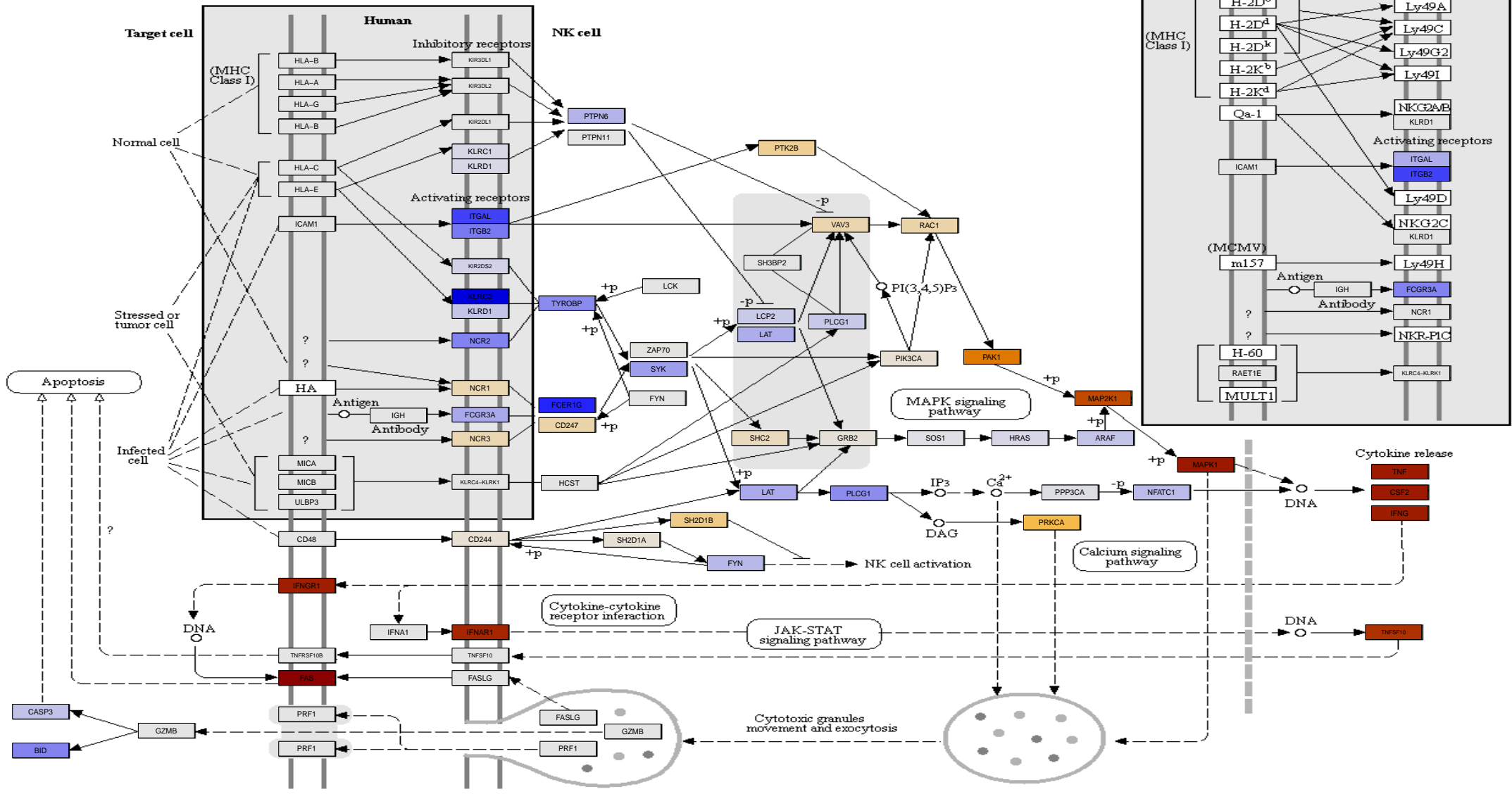

Natural_killer_cell_mediated_cytotoxicity
group 4

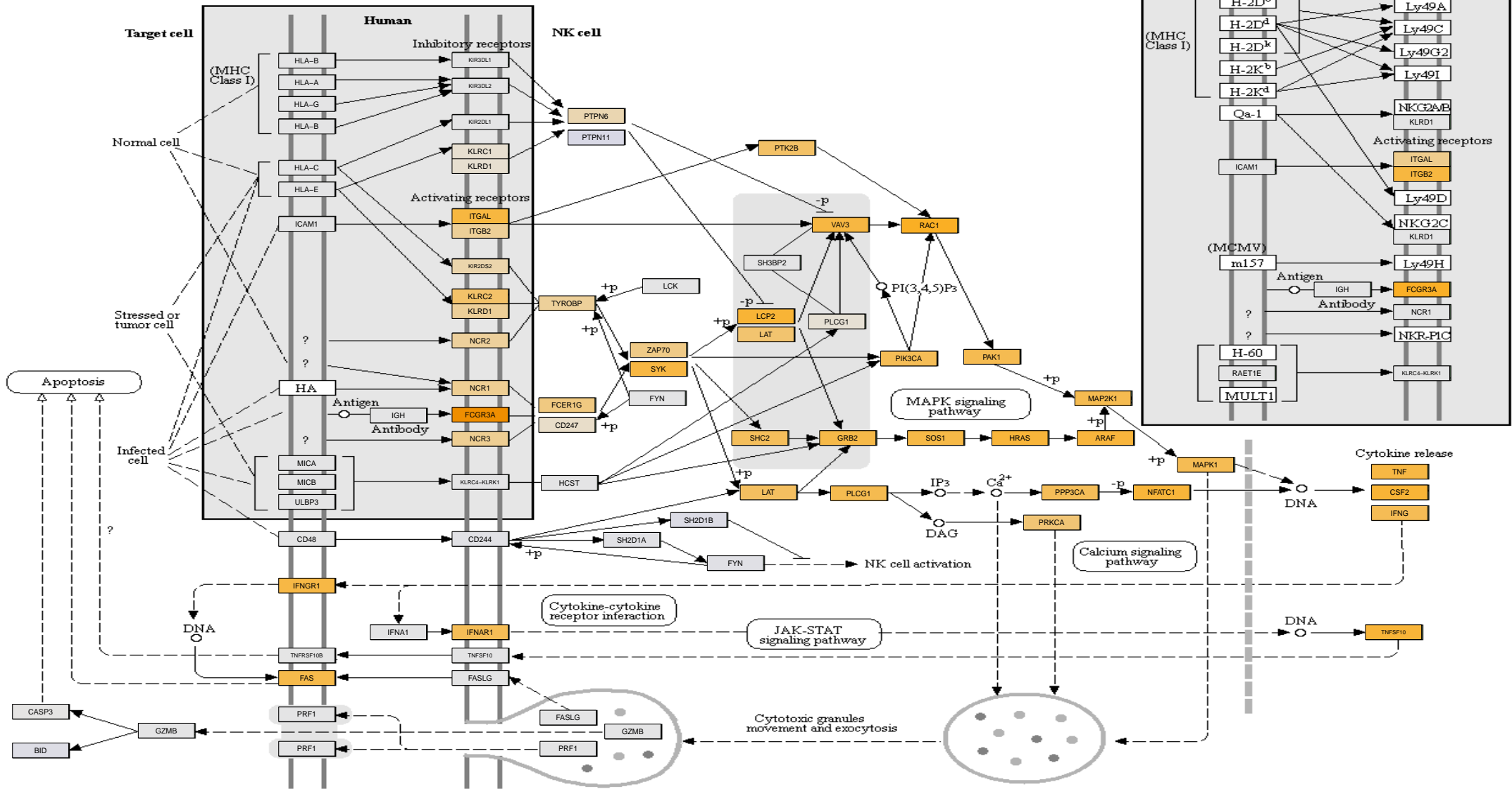

Natural killer cell mediated cytotoxicity group 5

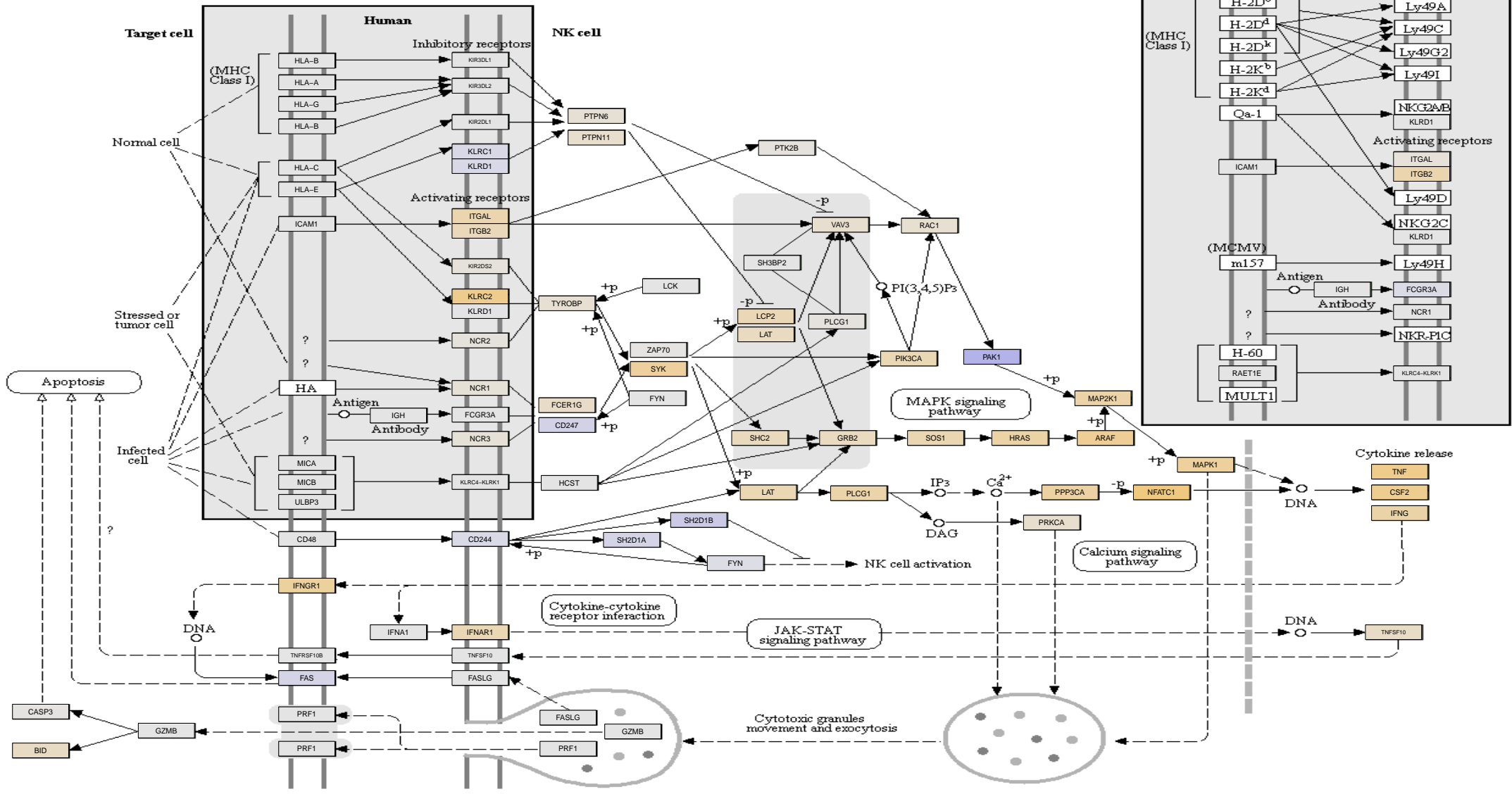

Natural_killer_cell_mediated_cytotoxicity group 6

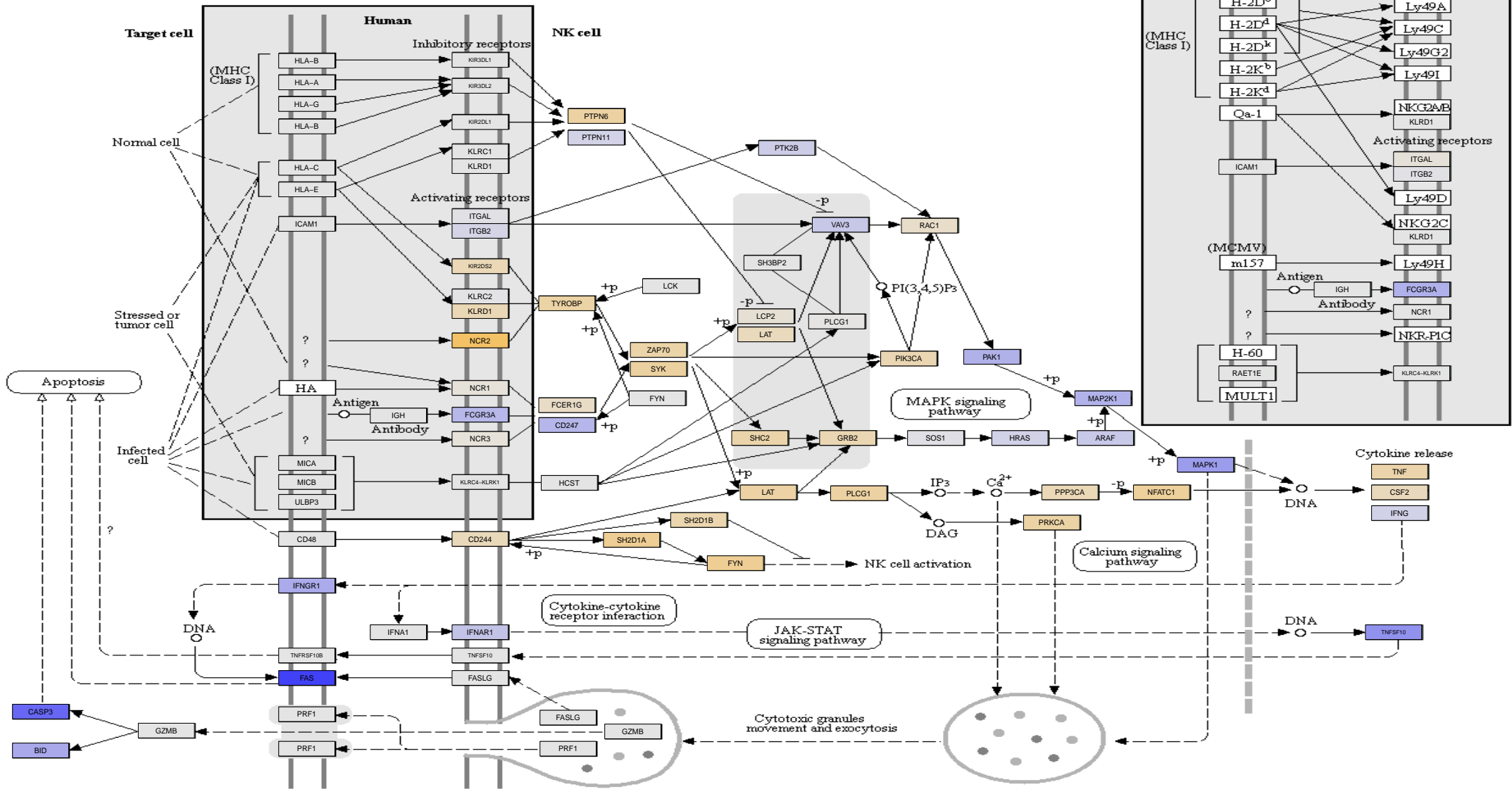

Natural killer cell mediated cytotoxicity group 7

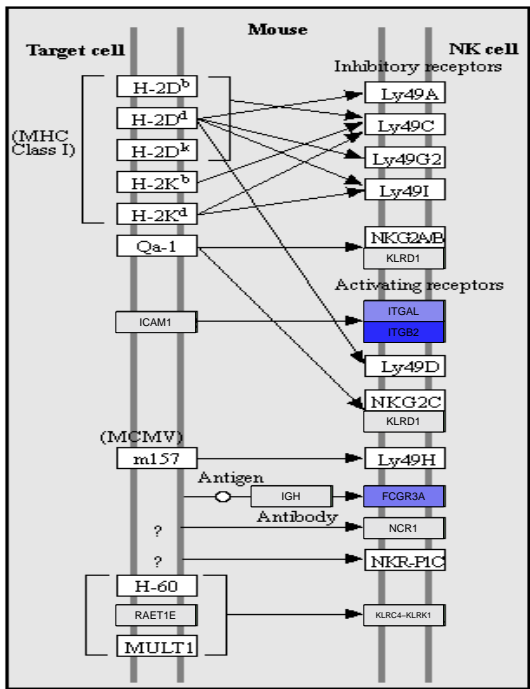
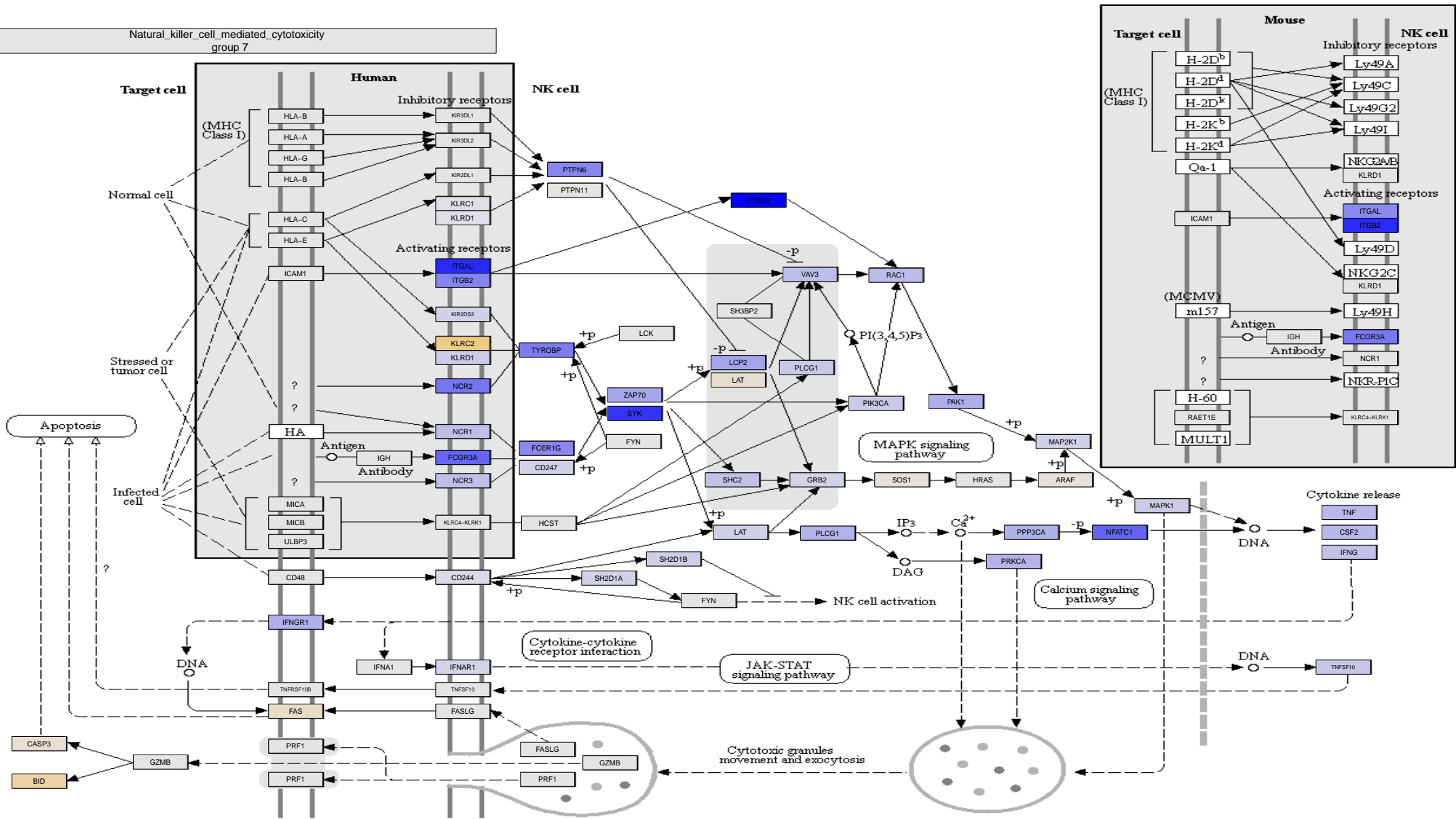

Natural_killer_cell_mediated_cytotoxicity group 8

