

# Glycosphingolipid biosynthesis – lac

all genes

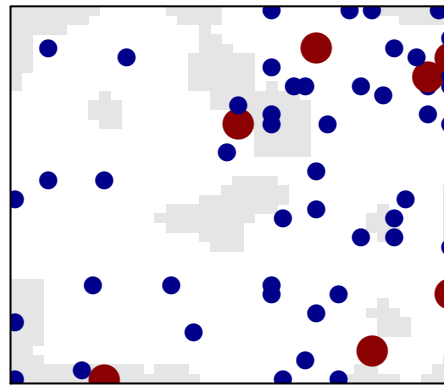

sink node genes

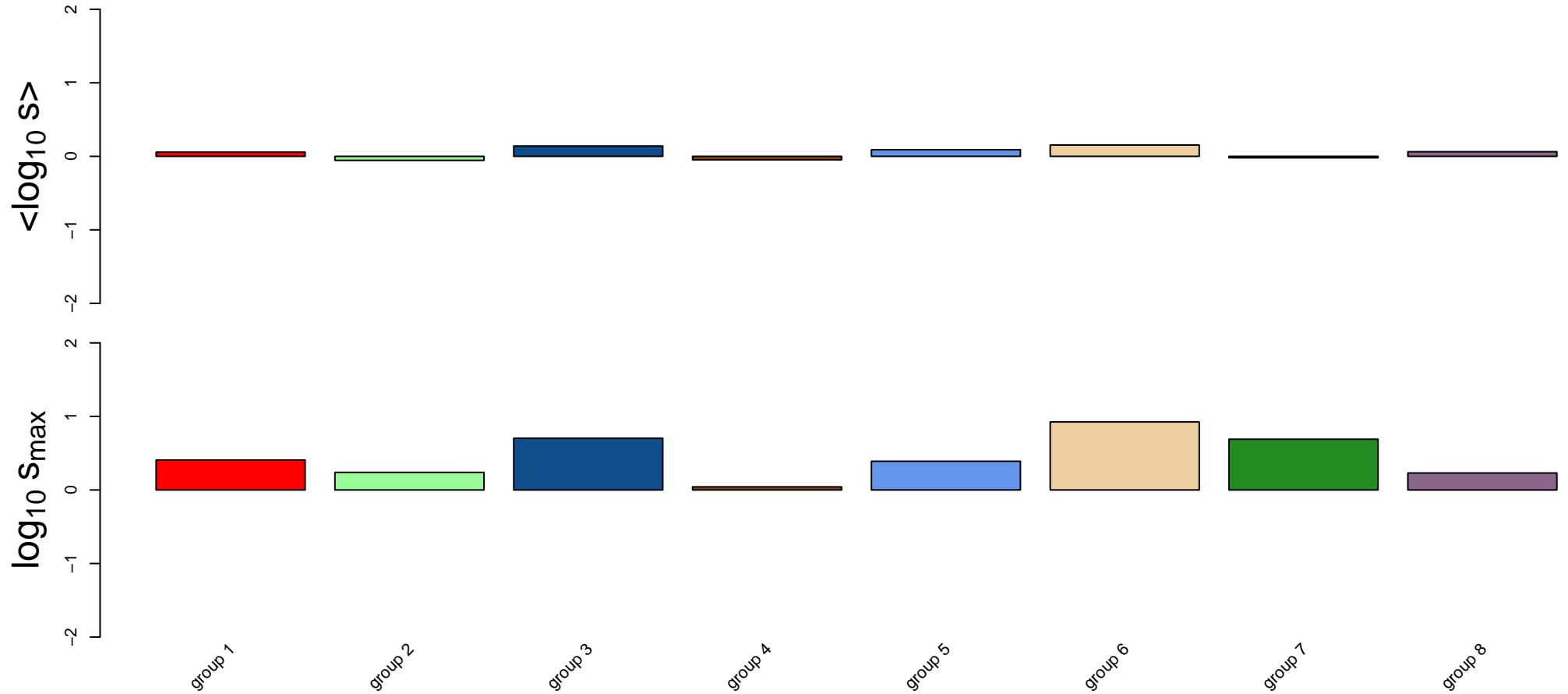
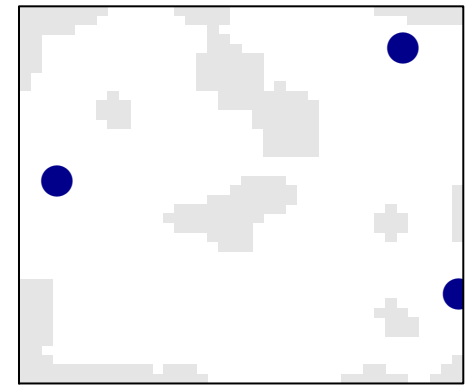

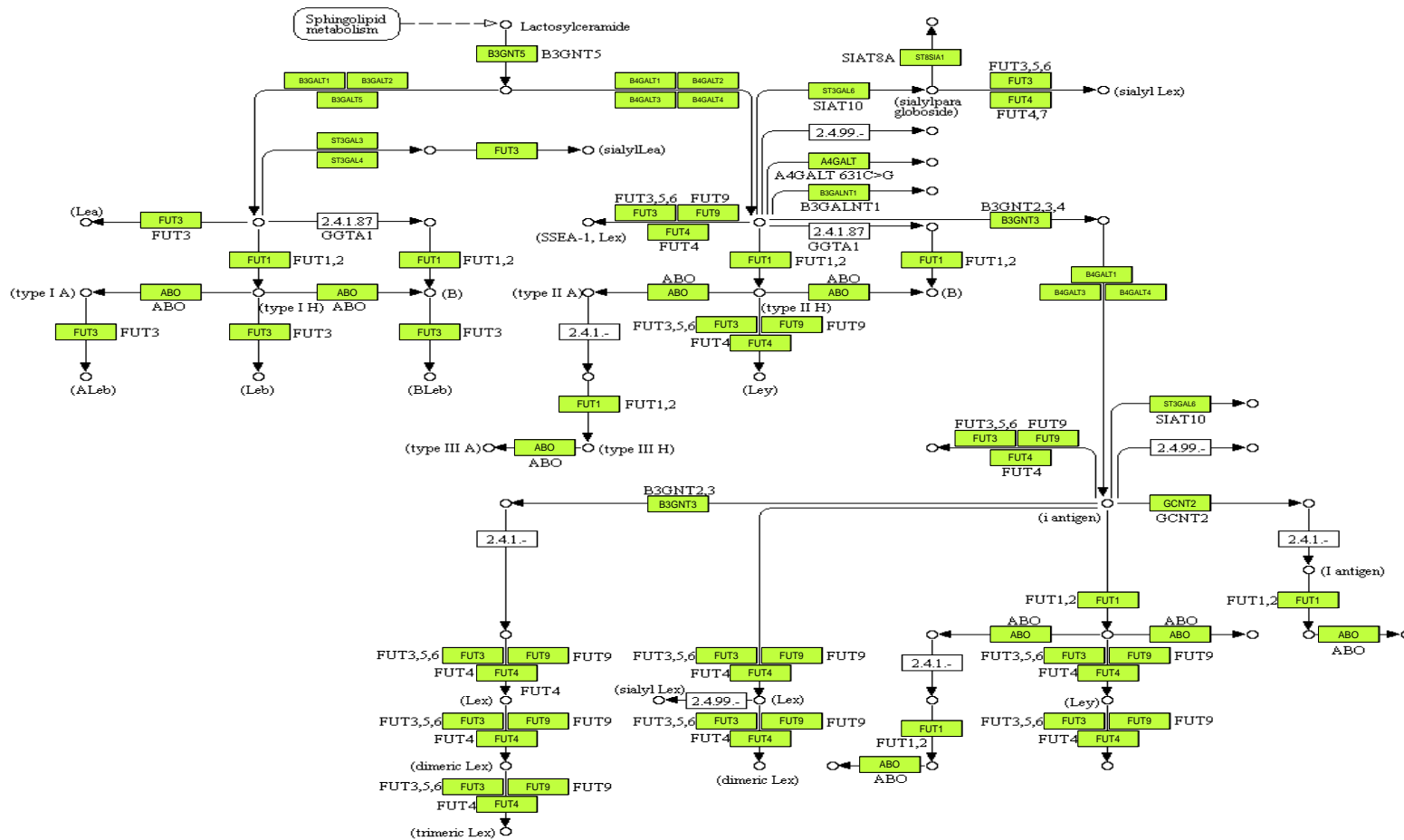

**Lacto series**

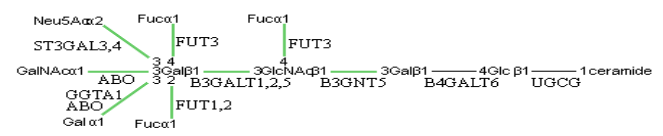

**Neolacto series**

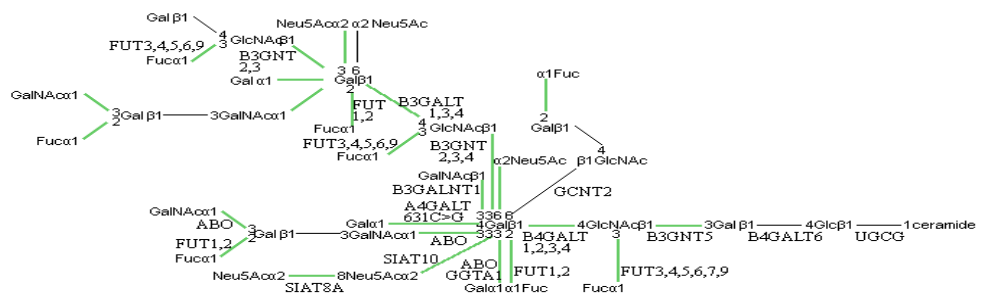

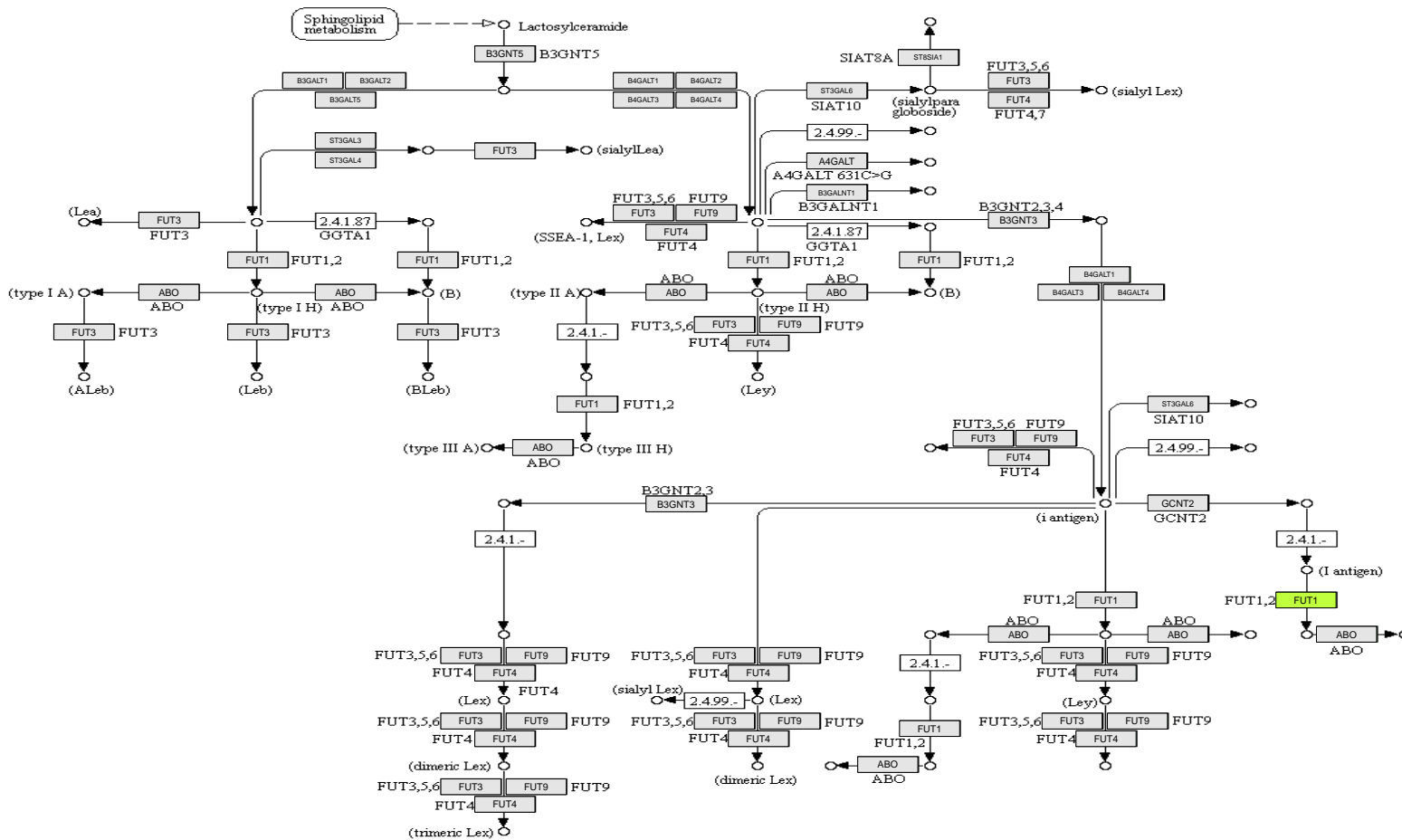

**Lacto series**

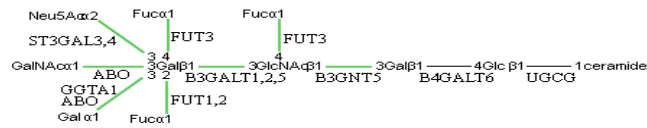

**Neolacto series**

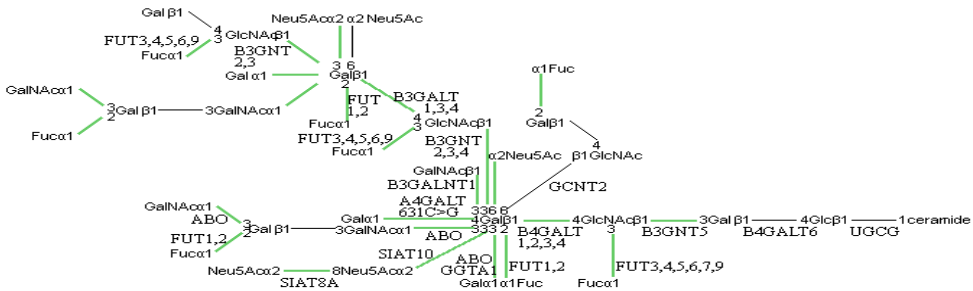

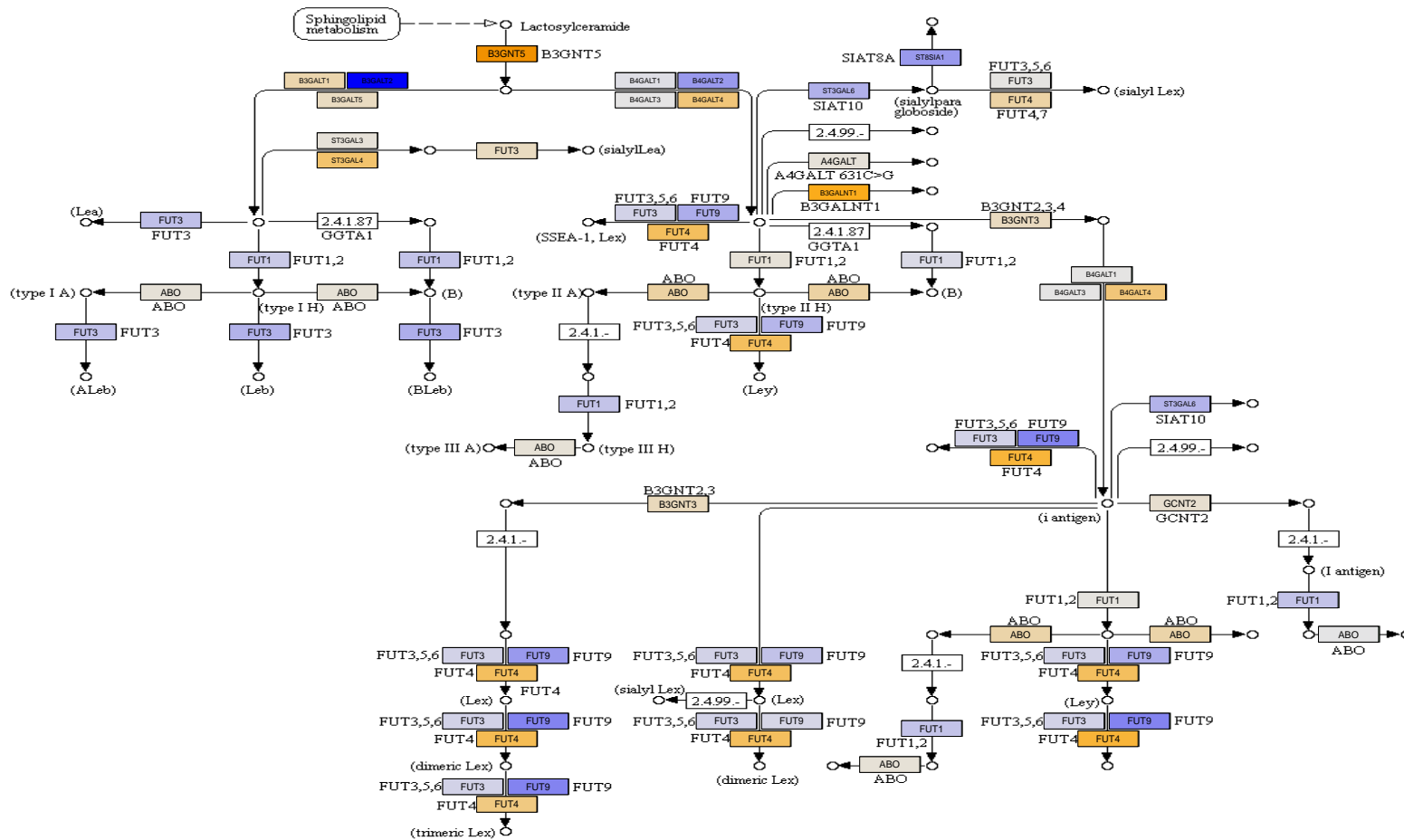

**Lacto series**

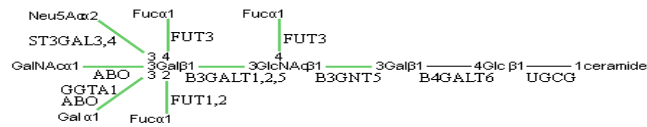

**Neolacto series**

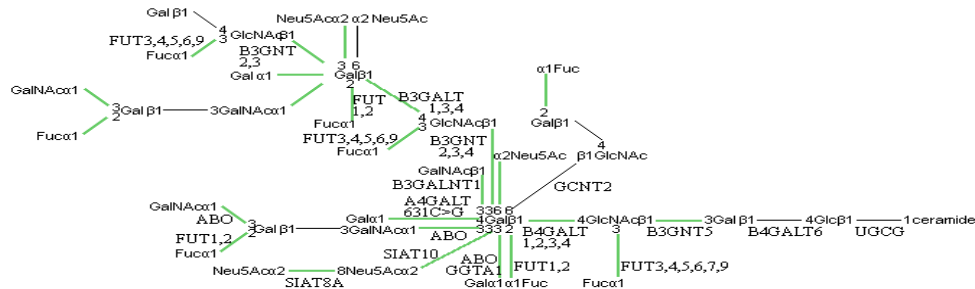

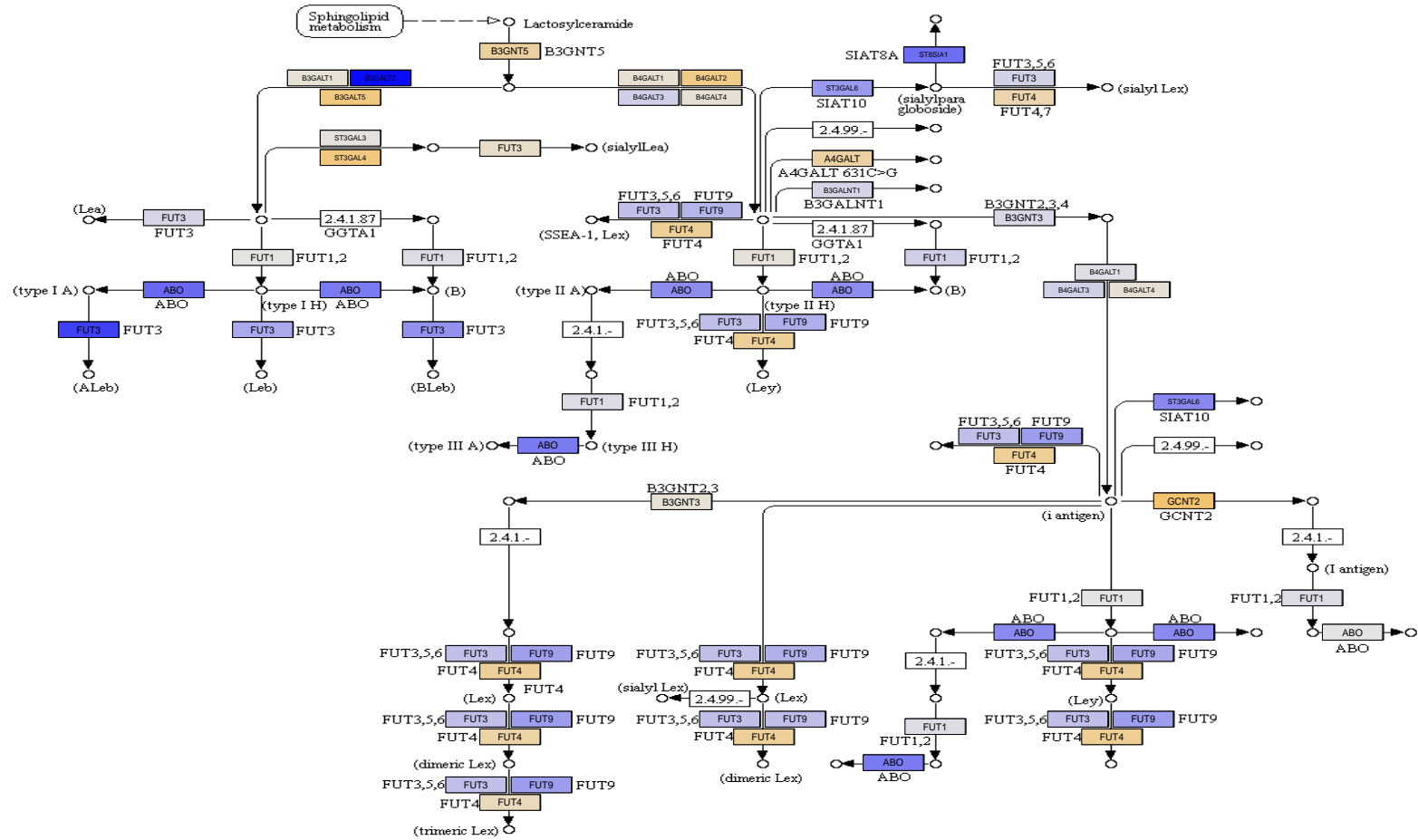

**Lacto series**

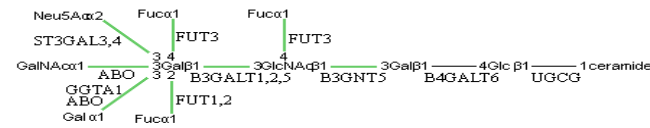

**Neolacto series**

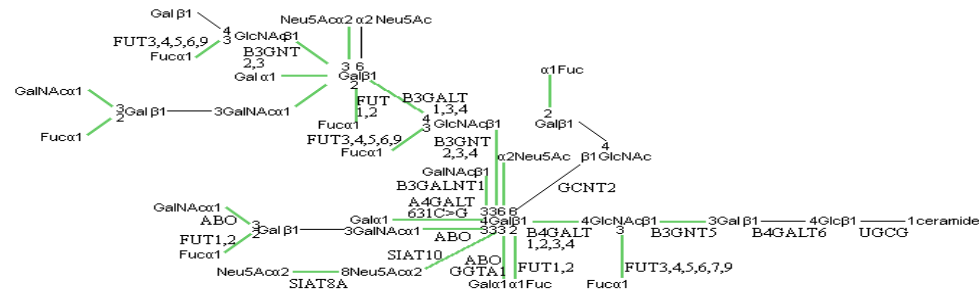

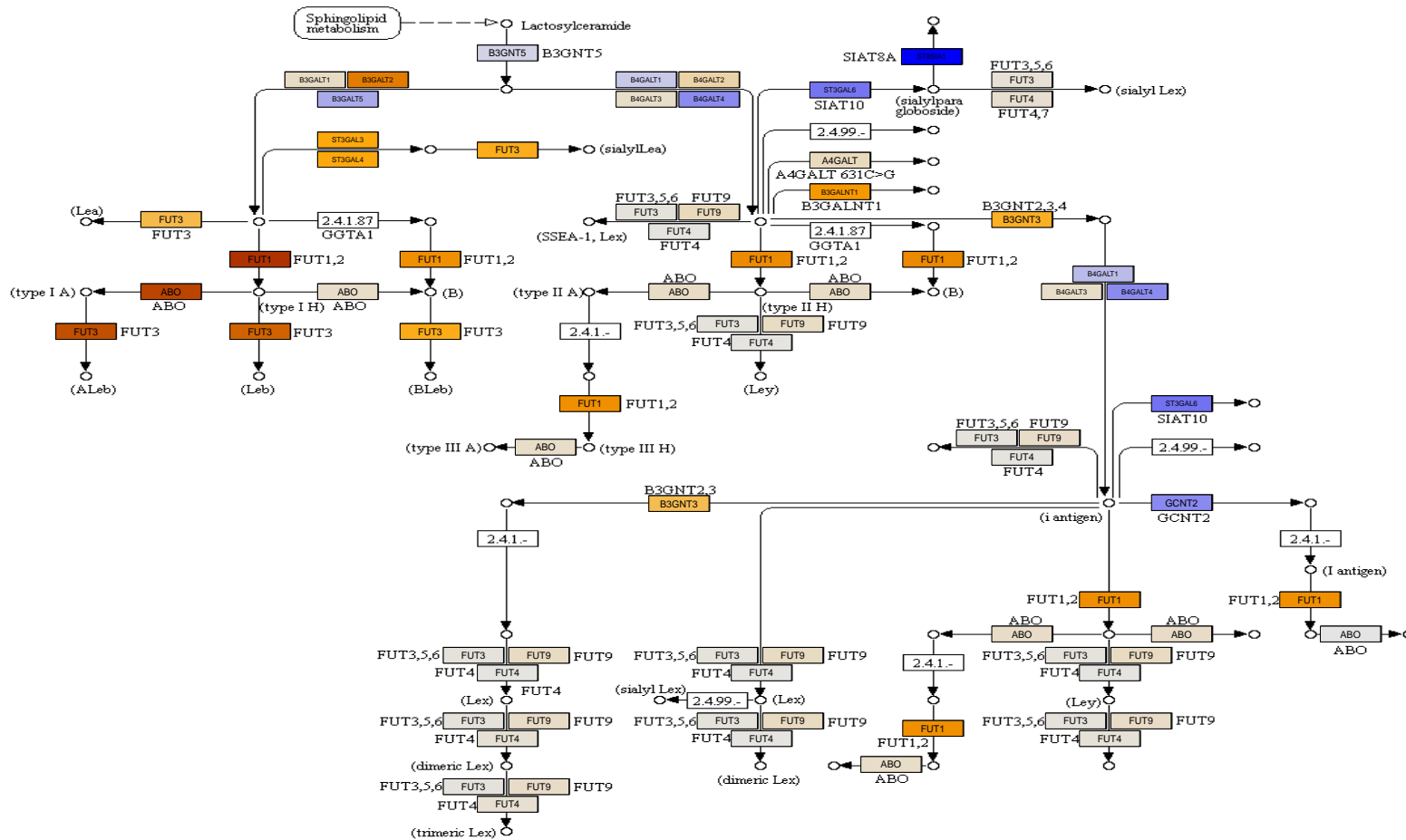

**Lacto series**

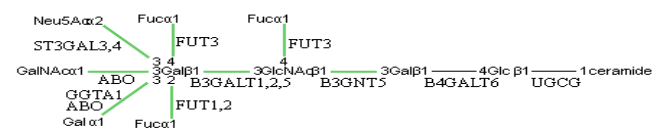

**Neolacto series**

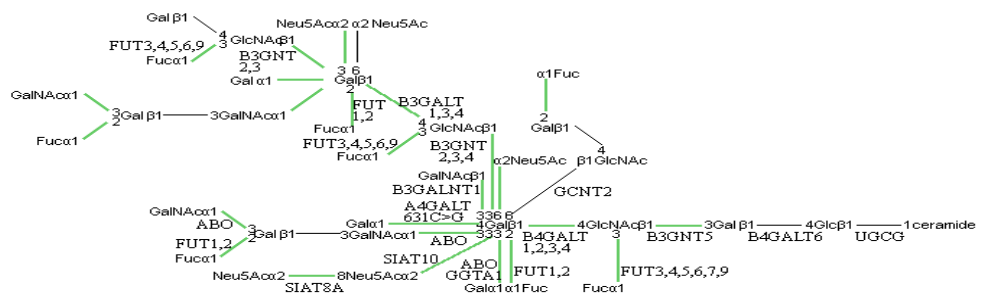

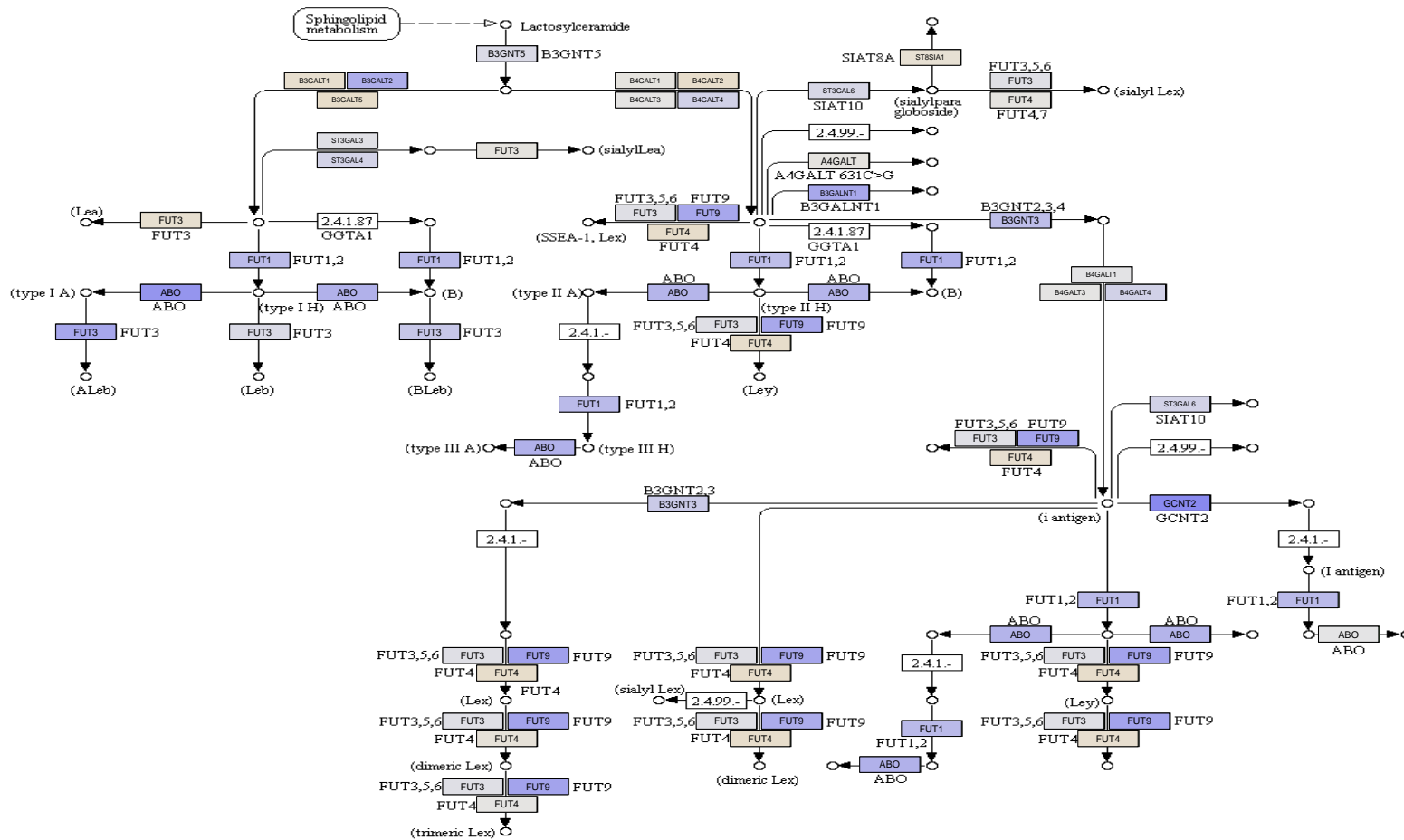

**Lacto series**

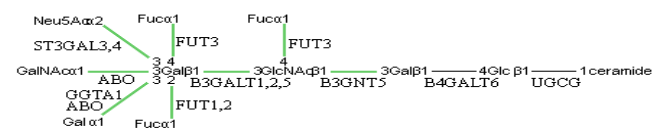

**Neolacto series**

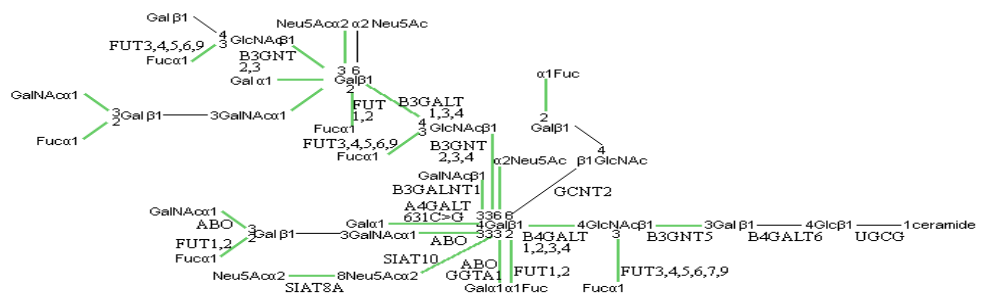

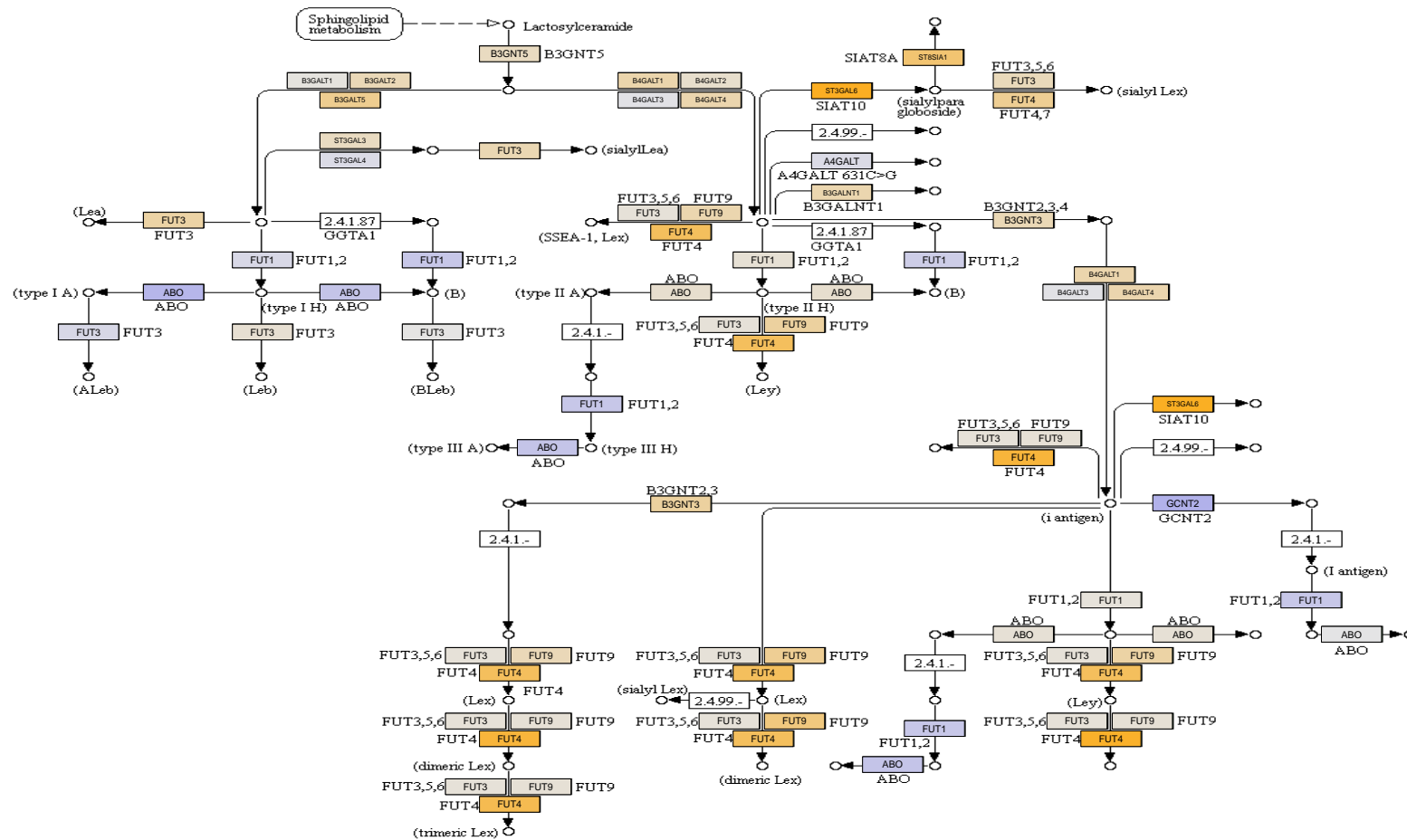

**Lacto series**

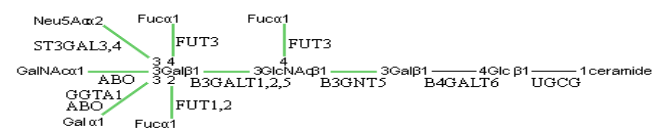

**Neolacto series**

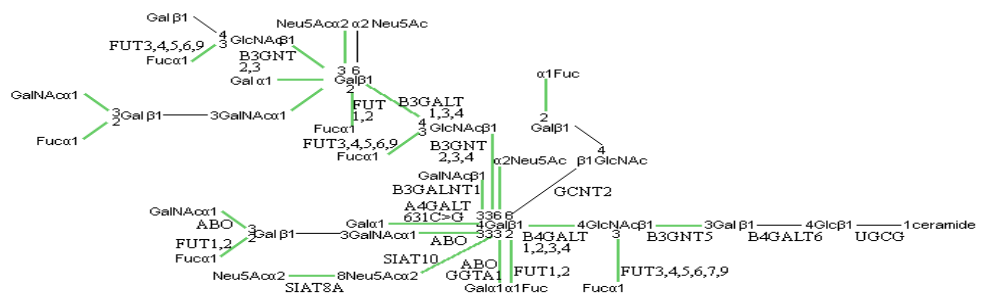



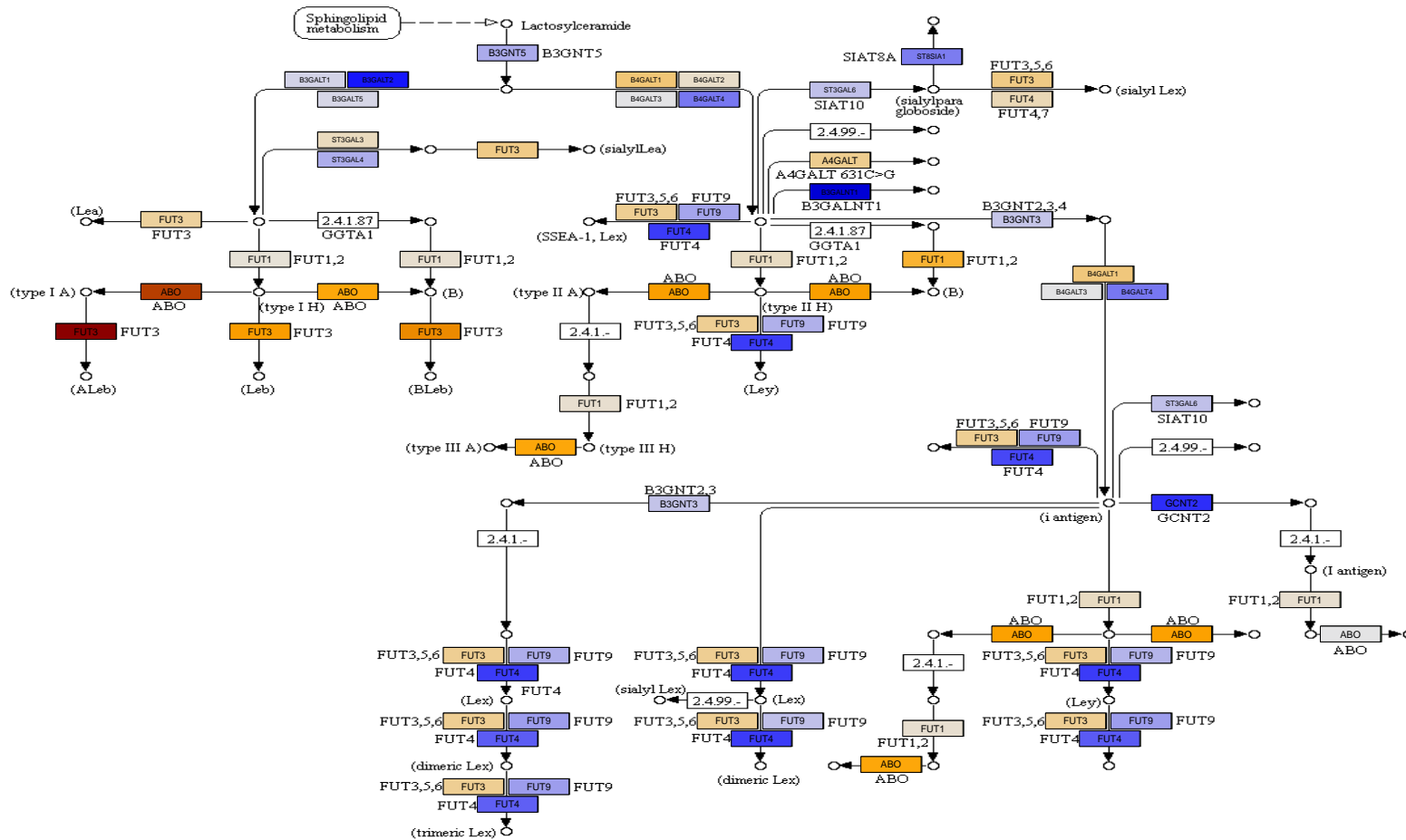

**Lacto series**

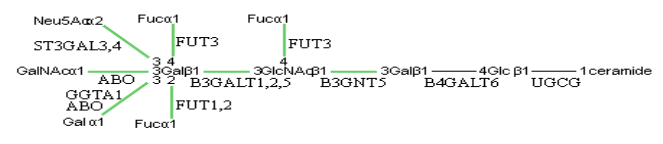

**Neolacto series**

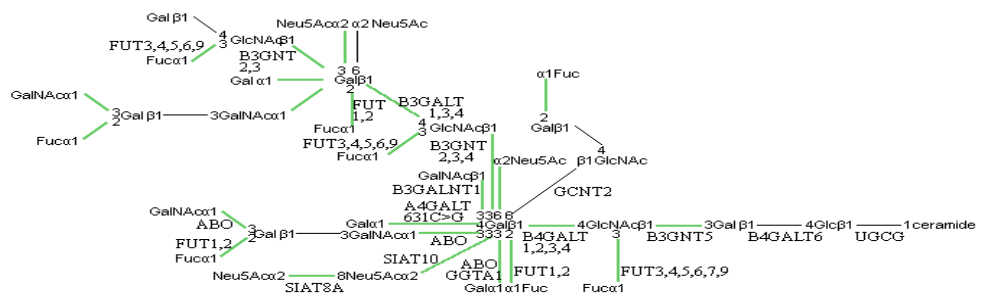

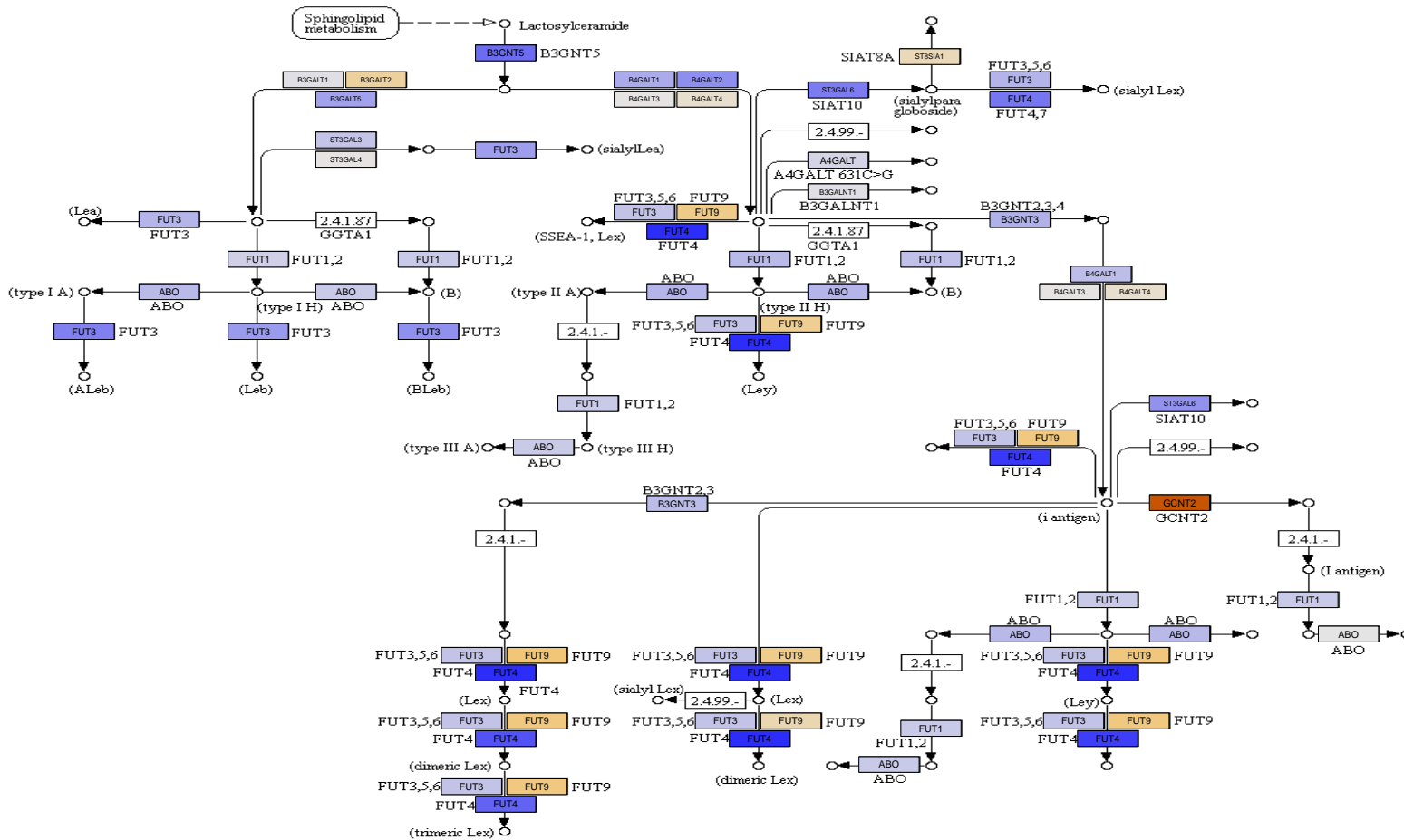

**Lacto series**

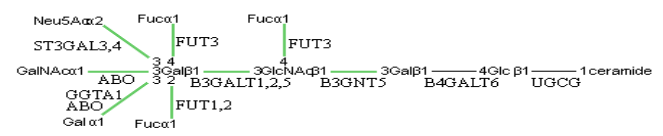

**Neolacto series**

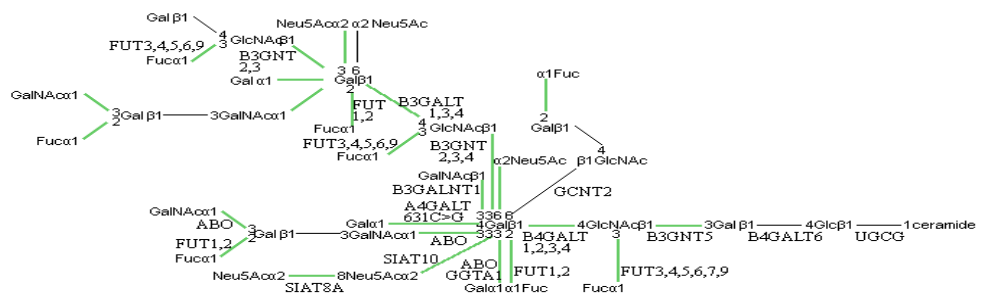

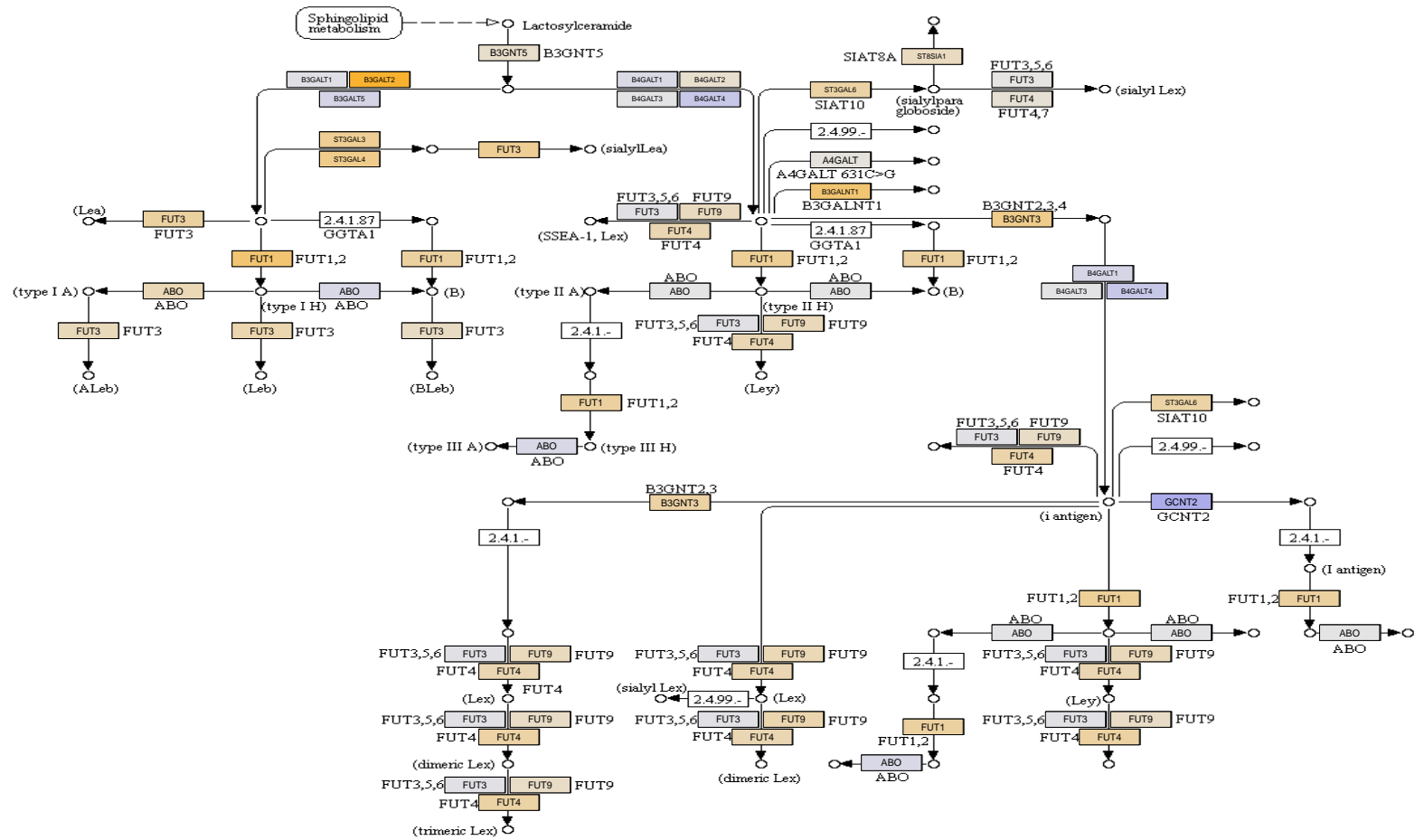

**Lacto series**

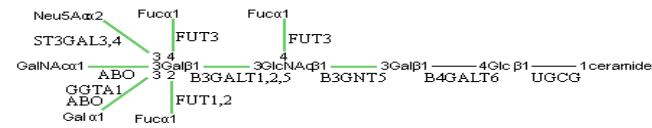

**Neolacto series**

