

Cytokine-cytokine receptor interact

all genes

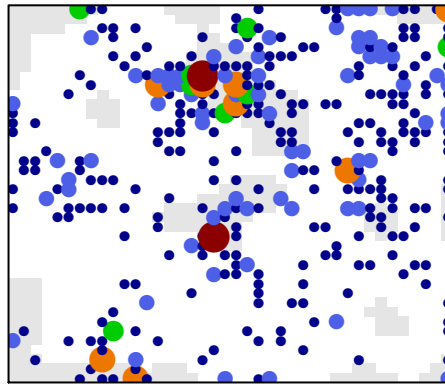

maximum = 5

sink node genes

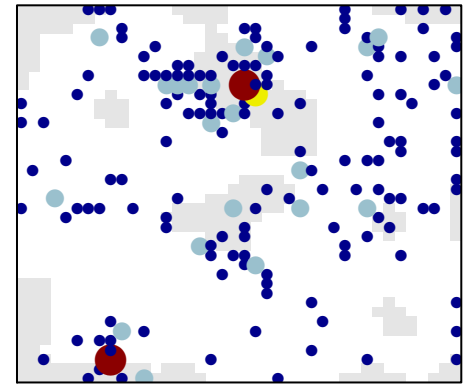

maximum = 4

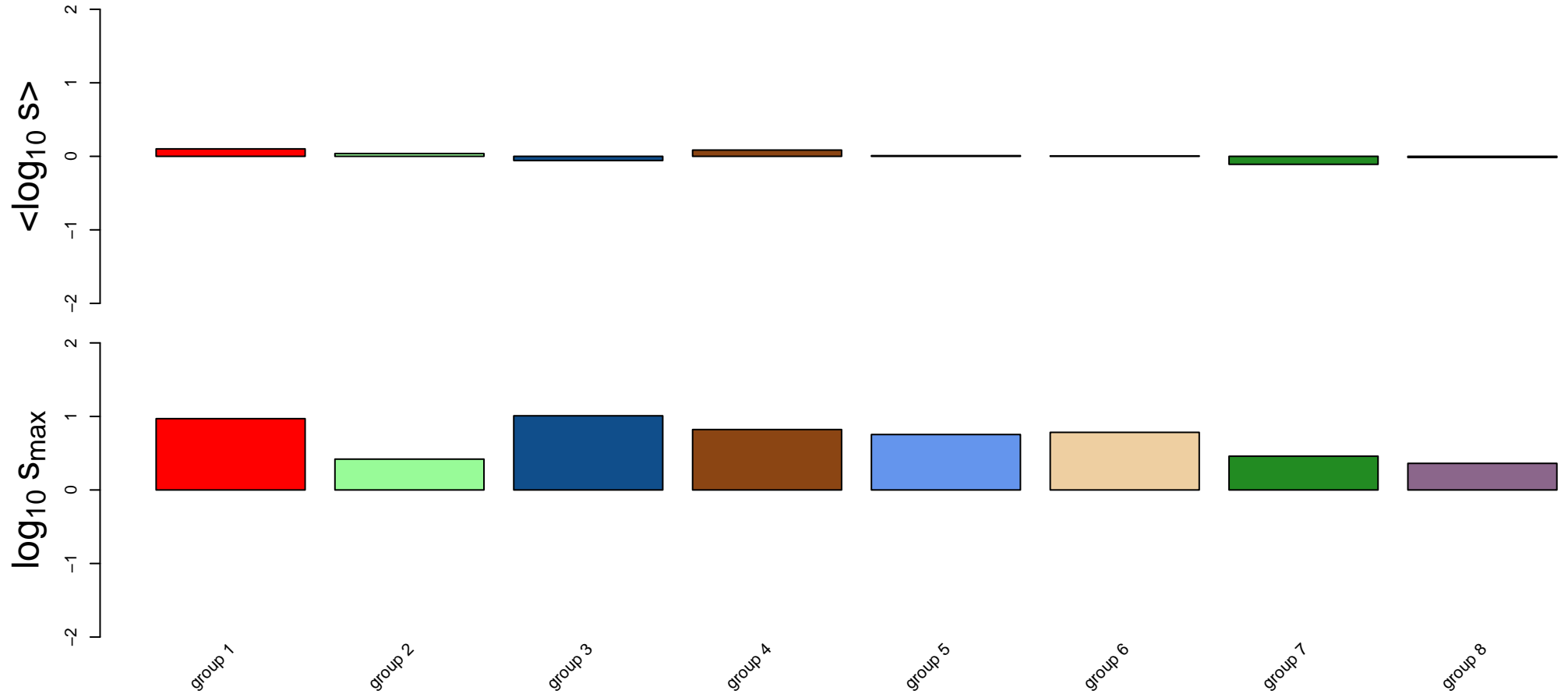

Cytokine_cytokine_receptor_interaction genes with data

Chemokines

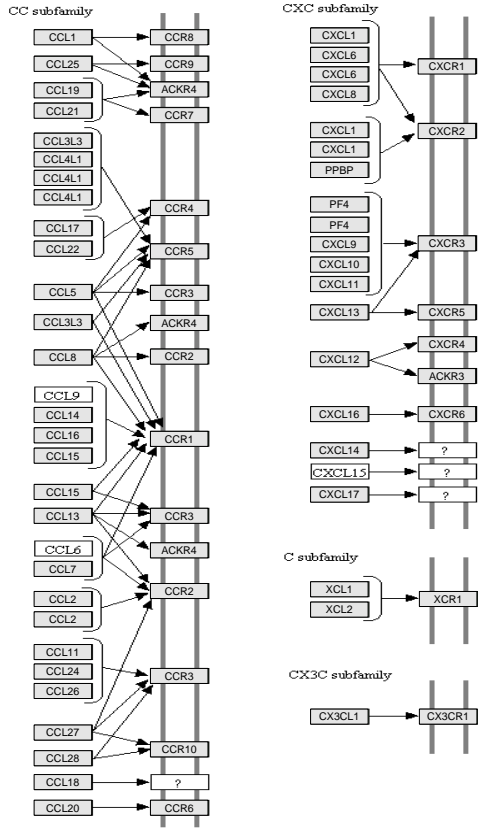

The class I helical cytokines
γ-chain utilizing

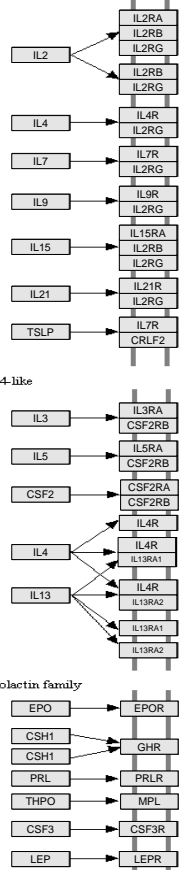

IL6/12-like

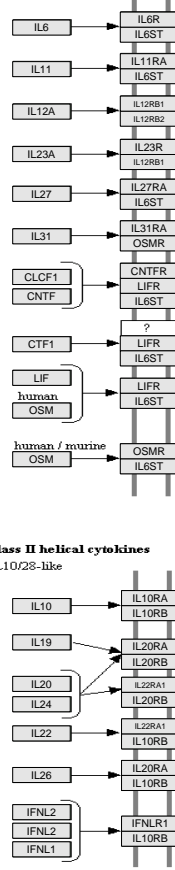

Interferon family

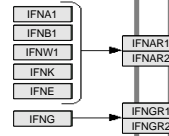

IL1-like cytokines

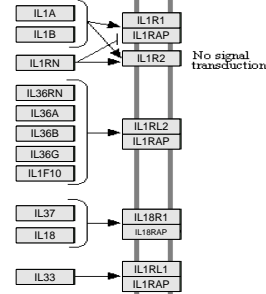

IL17-like cytokines

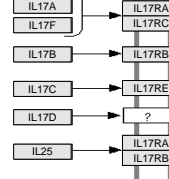

Non-classified

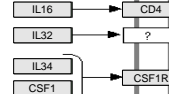

TNF Family

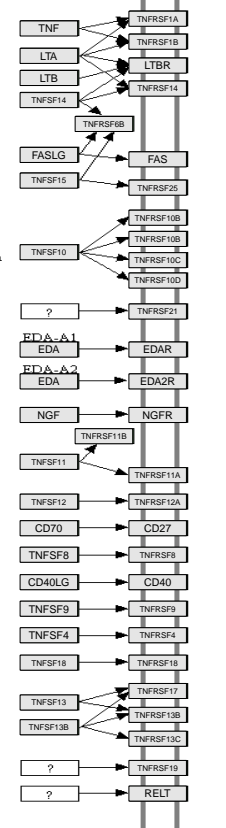

TGF-β family

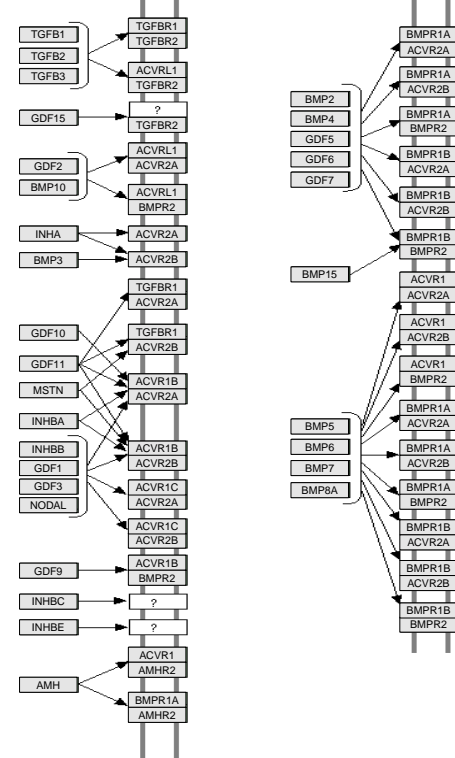

Cytokine_cytokine_receptor_interaction
sink nodes

Chemokines

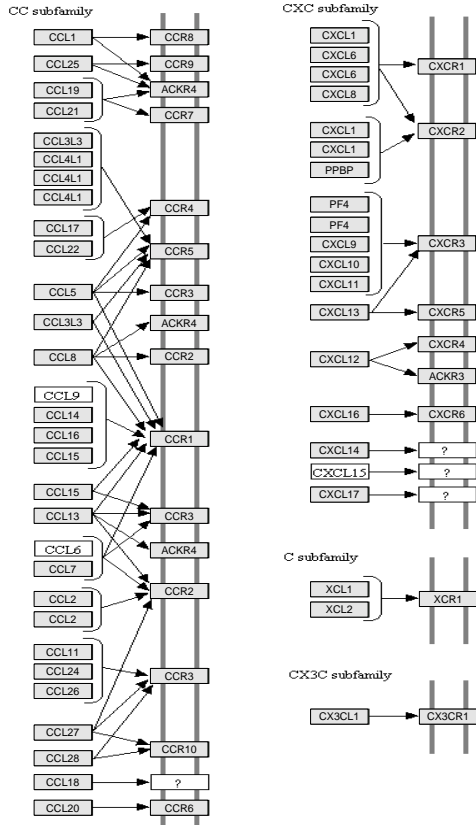

The class I helical cytokines
γ-chain utilizing

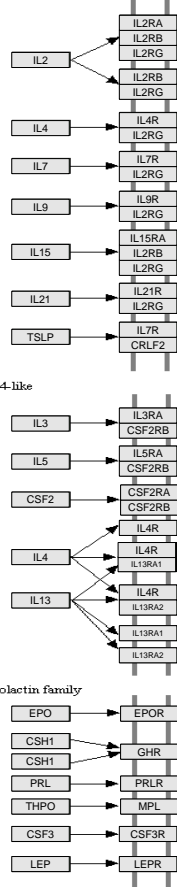

IL6/12-like

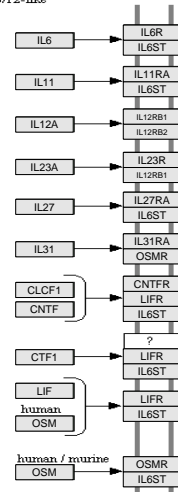

The class II helical cytokines

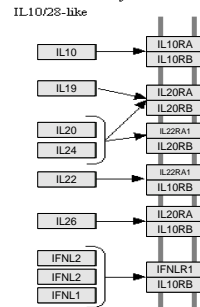

Interferon family

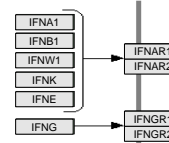

IL1-like cytokines

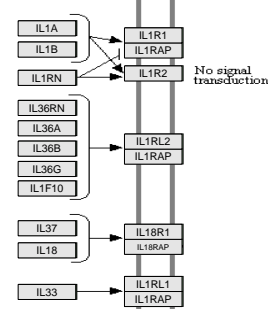

IL17-like cytokines

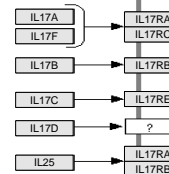

Non-classified

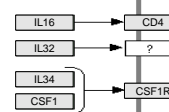

TNF Family

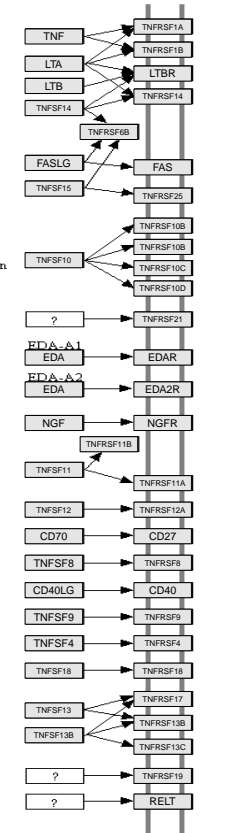

TGF-β family

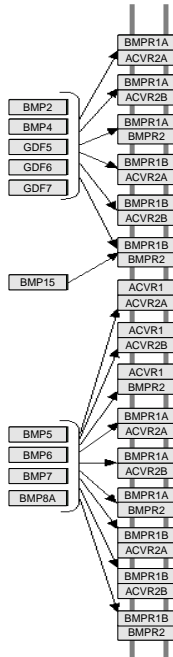
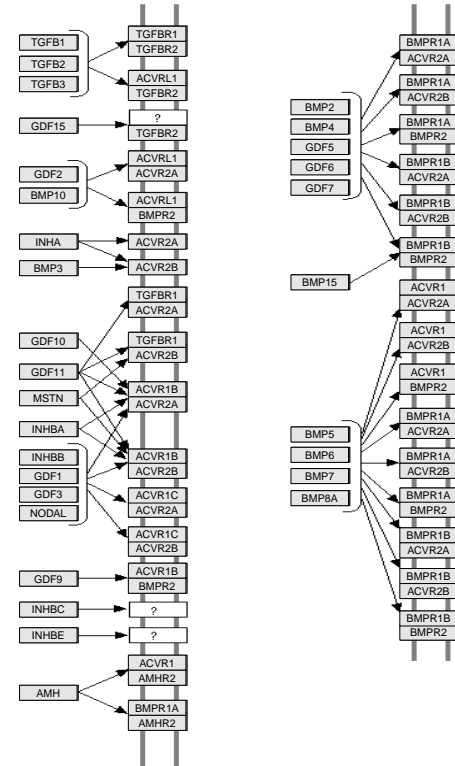

Cytokine_cytokine_receptor_interaction group 1

Chemokines

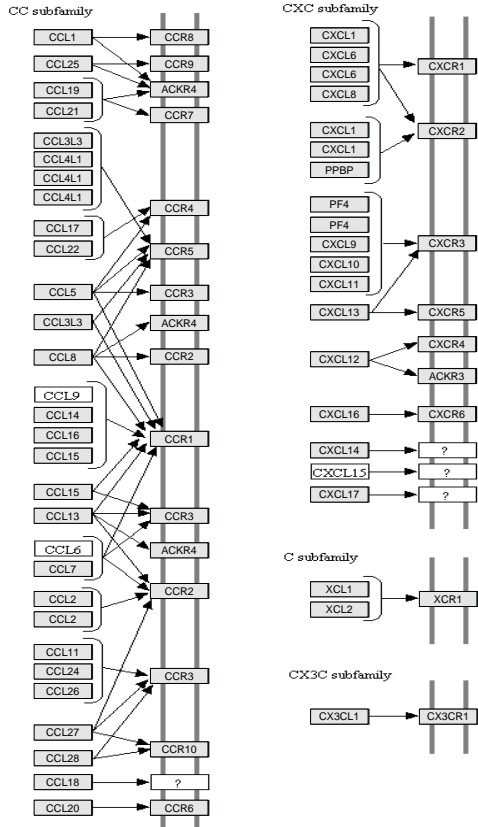

The class I helical cytokines
γ-chain utilizing

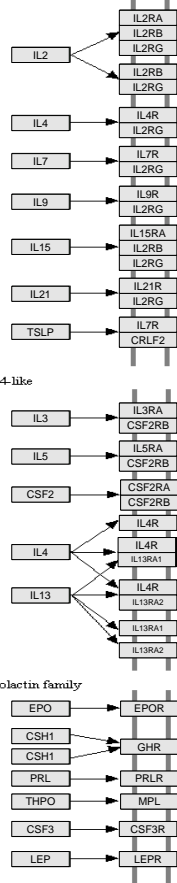

IL6/12-like

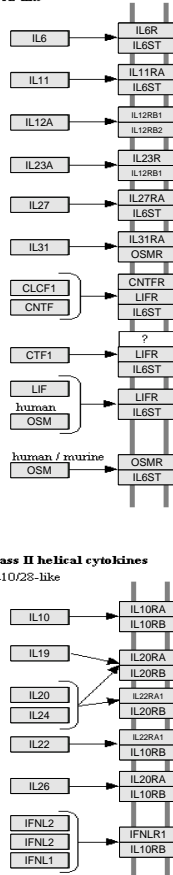

Interferon family

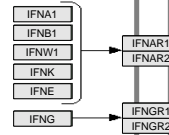

IL1-like cytokines

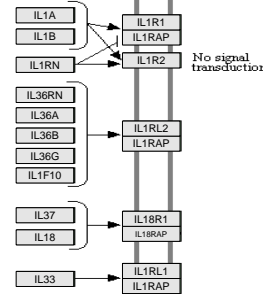

IL17-like cytokines

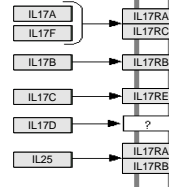

Non-classified

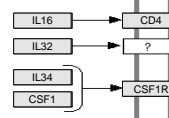

TNF Family

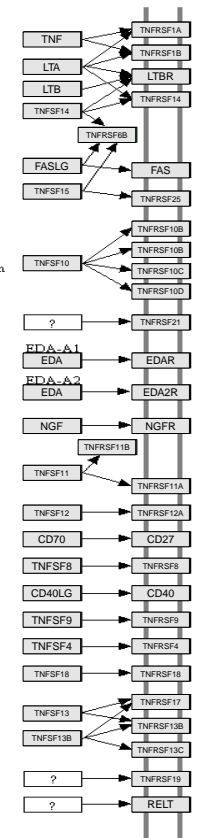

TGF-β family

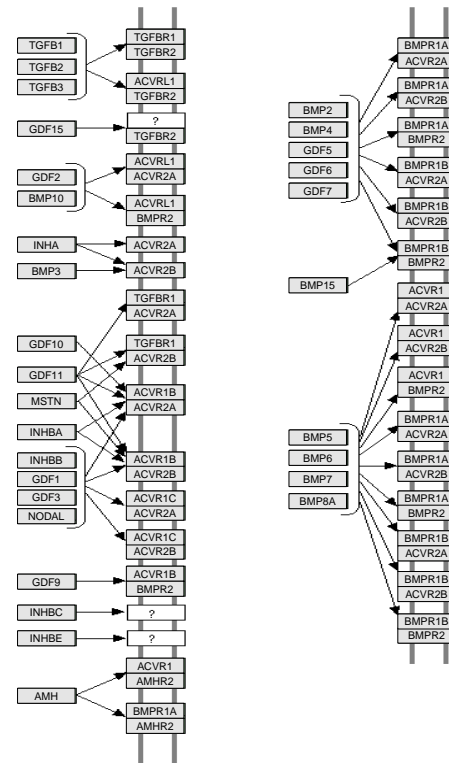

Cytokine_cytokine_receptor_interaction group 2

Chemokines

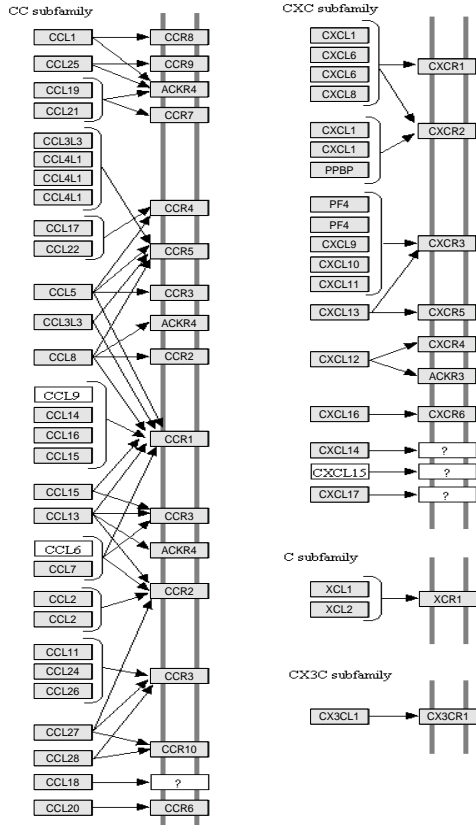

The class I helical cytokines
γ-chain utilizing

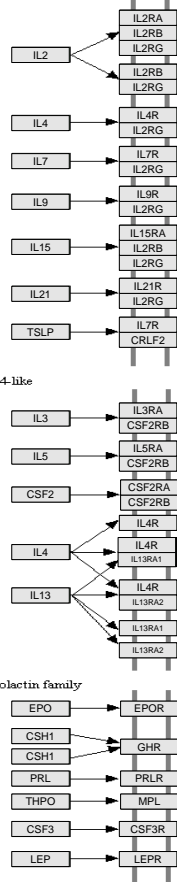

IL6/12-like

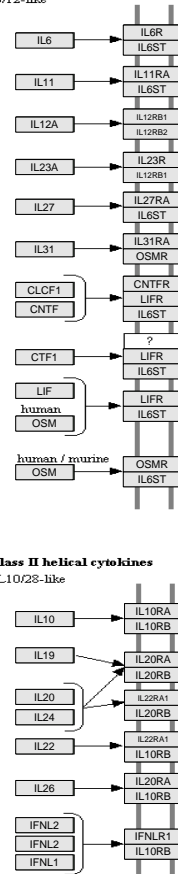

Interferon family

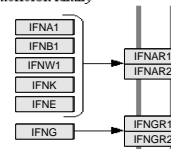

IL1-like cytokines

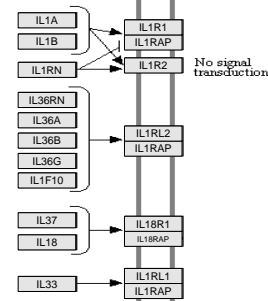

IL17-like cytokines

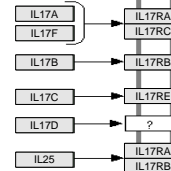

Non-classified

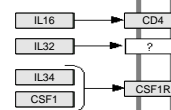

TNF Family

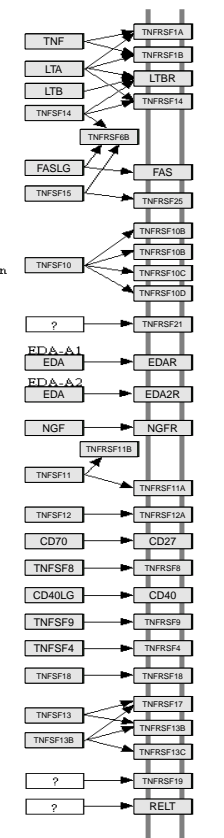

TGF-β family

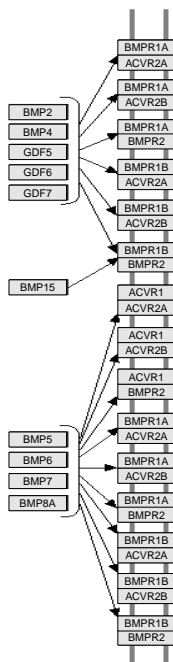
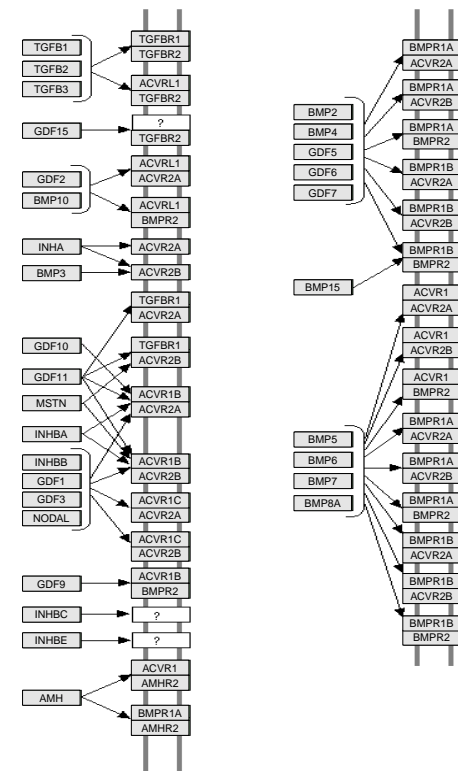

Cytokine_cytokine_receptor_interaction group 3

Chemokines

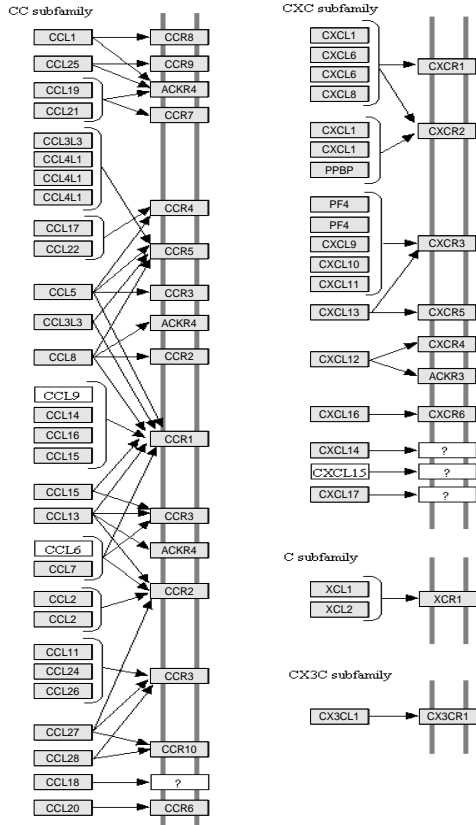

The class I helical cytokines
γ-chain utilizing

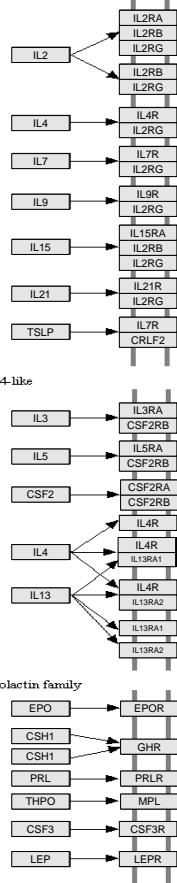

IL6/12-like

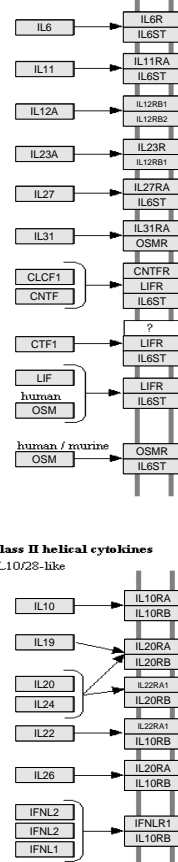

Interferon family

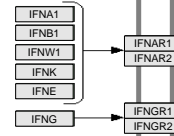

IL1-like cytokines

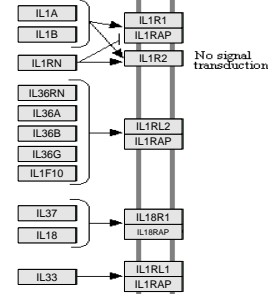

IL17-like cytokines

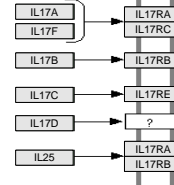

Non-classified

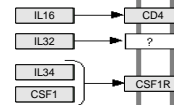

TNF Family

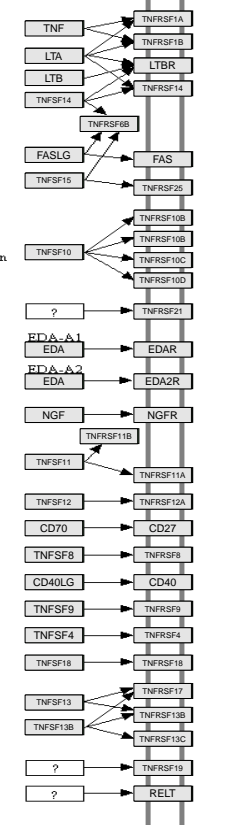

TGF-β family

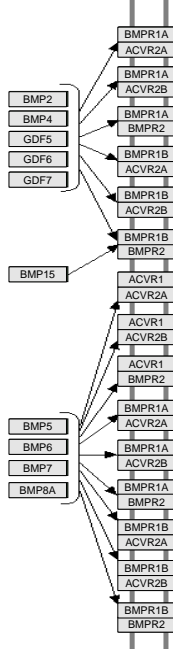
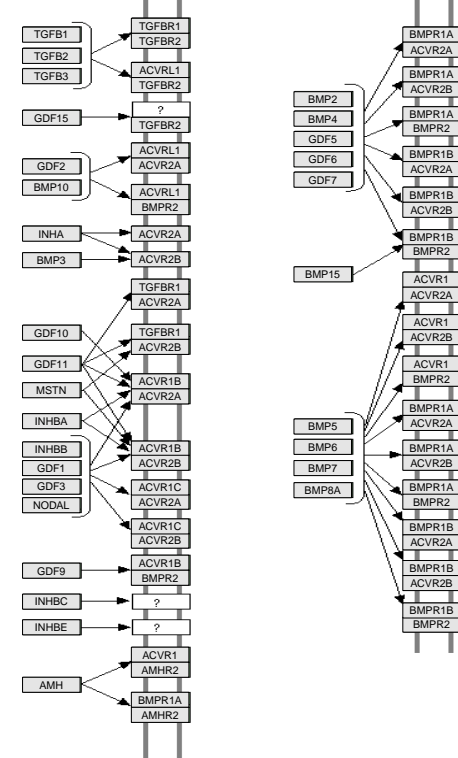

Cytokine_cytokine_receptor_interaction group 4

Chemokines

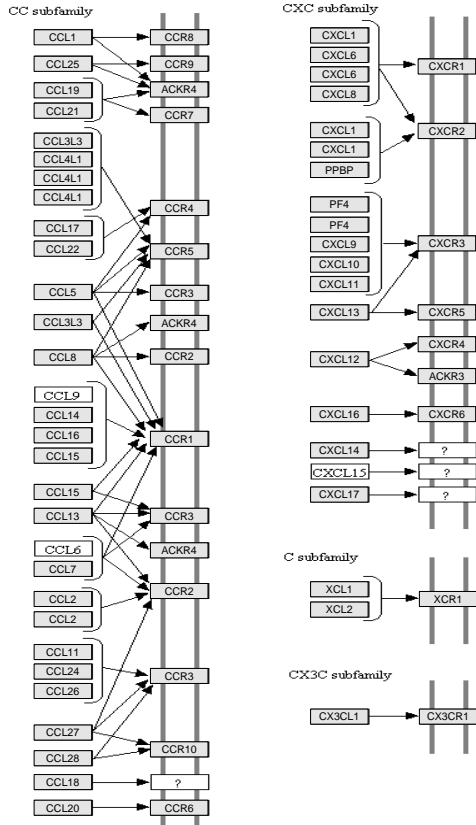

The class I helical cytokines
γ-chain utilizing

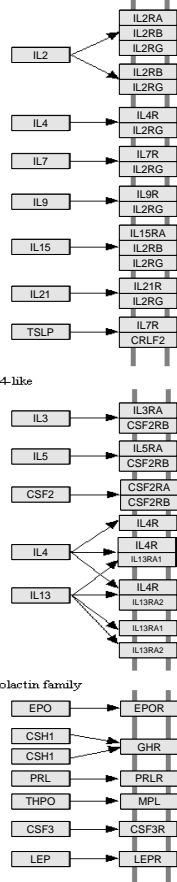

IL6/12-like

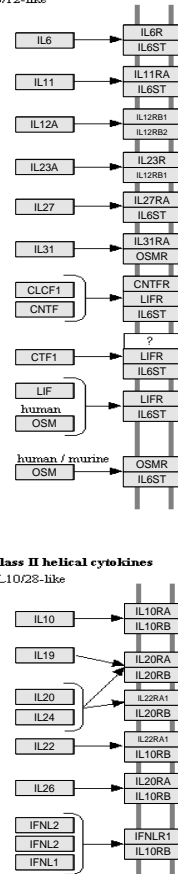

Interferon family

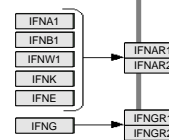

IL1-like cytokines

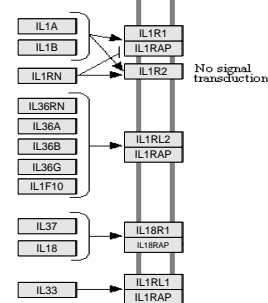

IL17-like cytokines

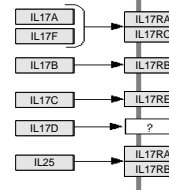

Non-classified

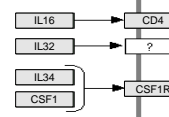

TNF Family

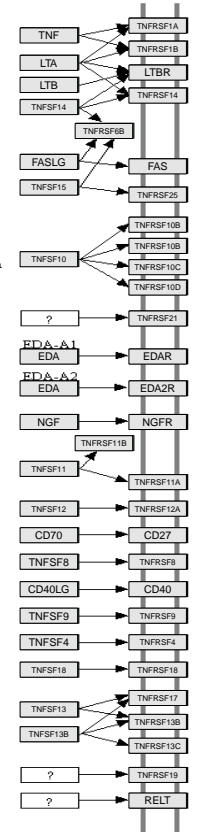

TGF-β family

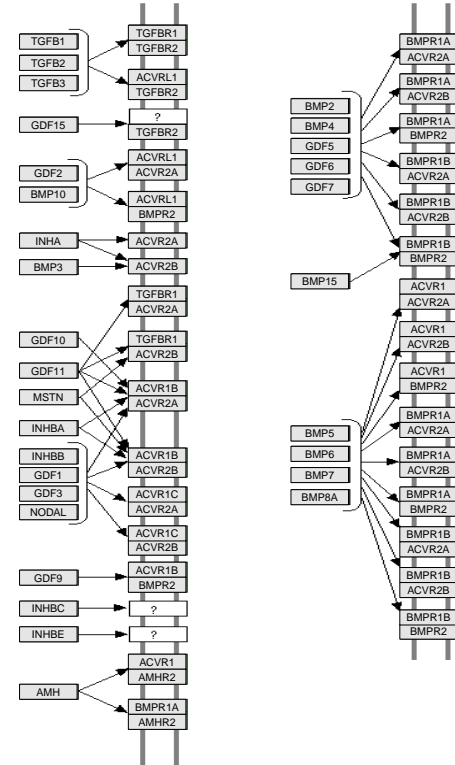

Cytokine_cytokine_receptor_interaction group 5

Chemokines

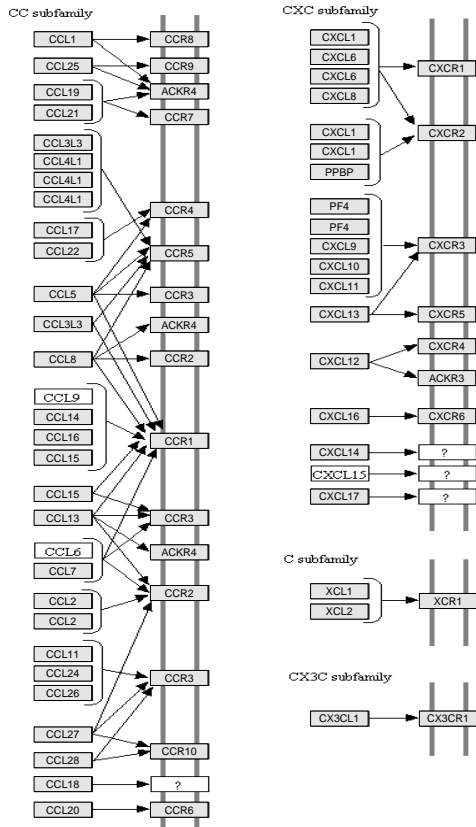

The class I helical cytokines
γ-chain utilizing

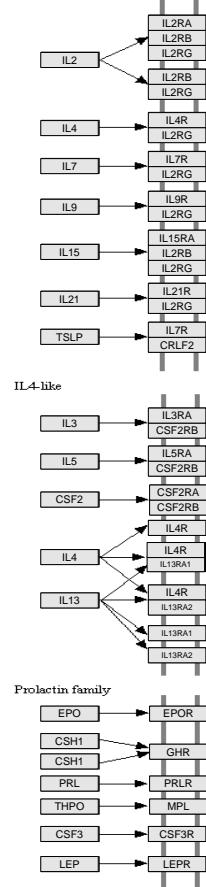

IL6/12-like

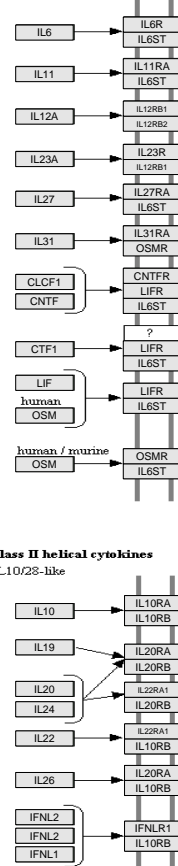

Interferon family

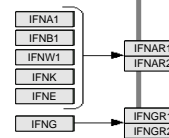

IL1-like cytokines

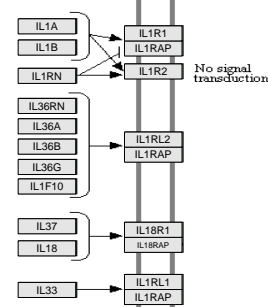

IL17-like cytokines

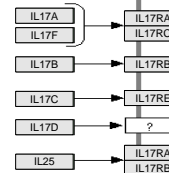

Non-classified

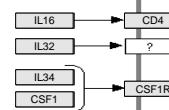

TNF Family

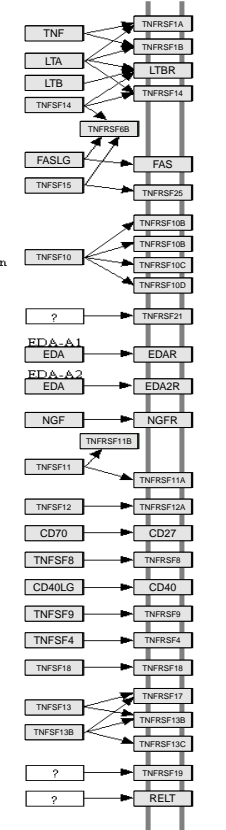

TGF-β family

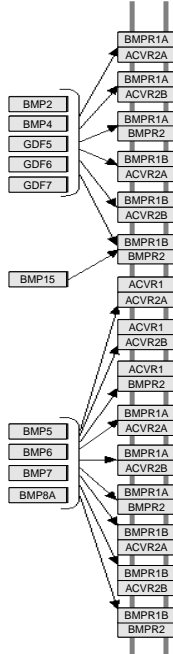
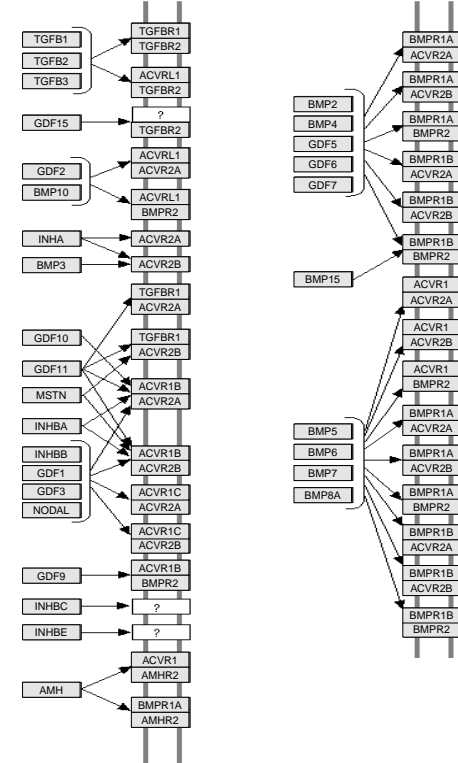

Cytokine_cytokine_receptor_interaction group 6

Chemokines

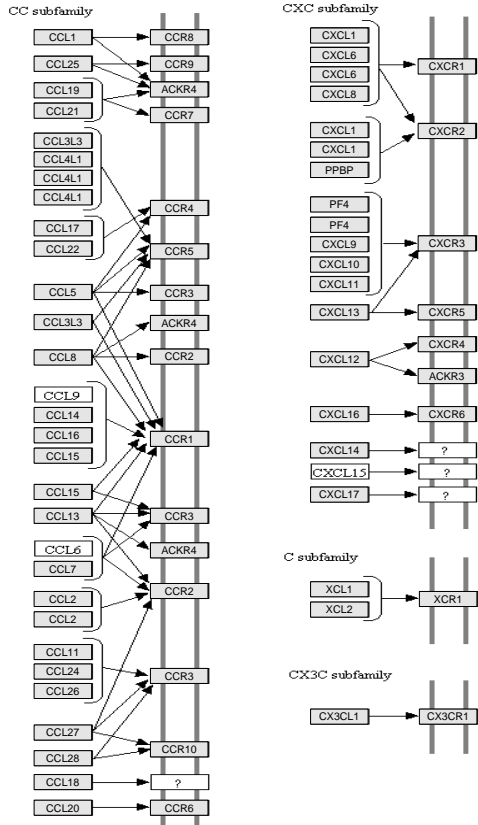

The class I helical cytokines
γ-chain utilizing

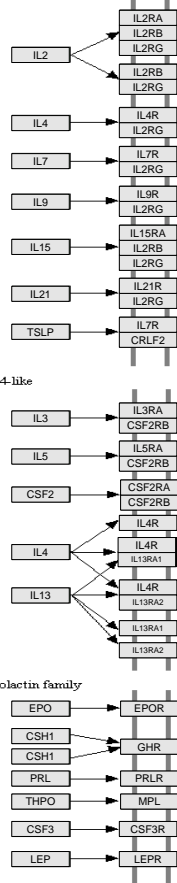

IL6/12-like

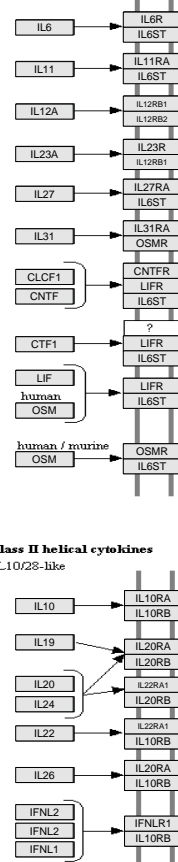

Interferon family

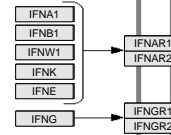

IL1-like cytokines

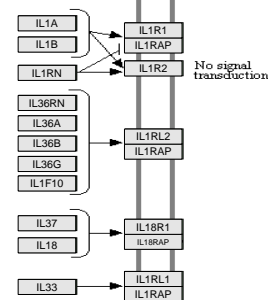

IL17-like cytokines

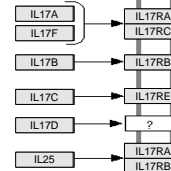

Non-classified

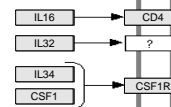

TNF Family

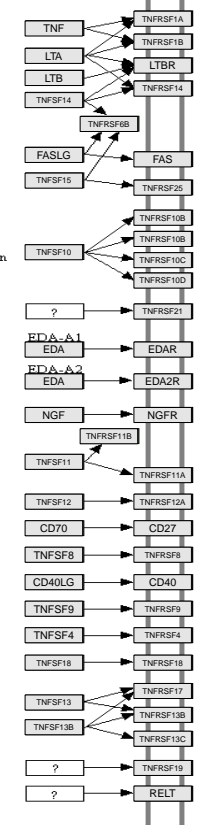

TGF-β family

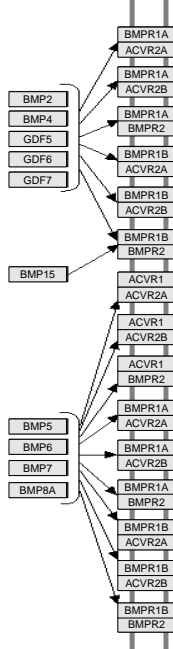
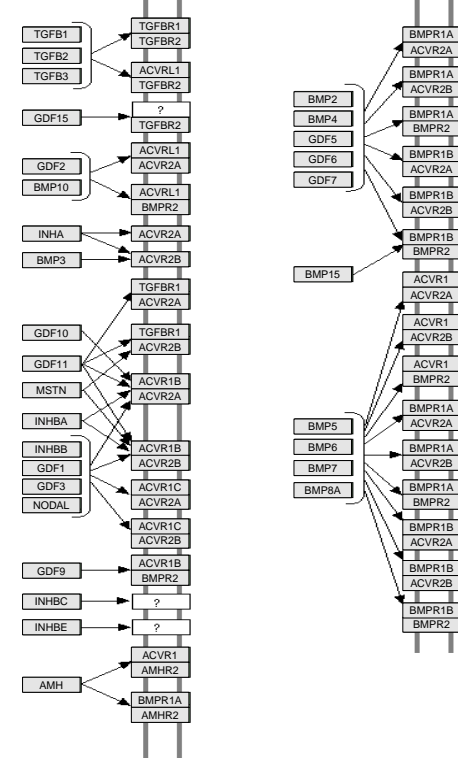

Cytokine_cytokine_receptor_interaction group 7

Chemokines

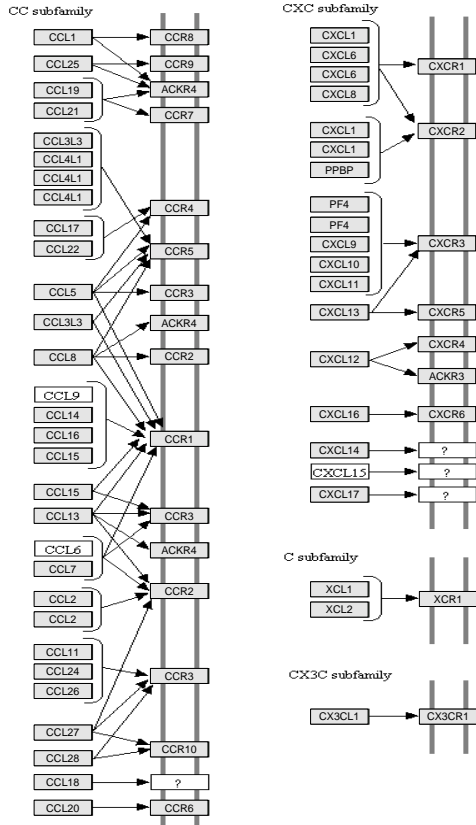

The class I helical cytokines
γ-chain utilizing

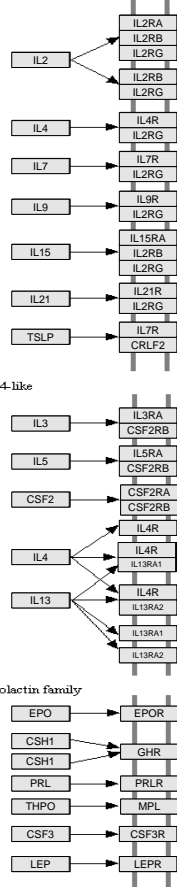

IL6/12-like

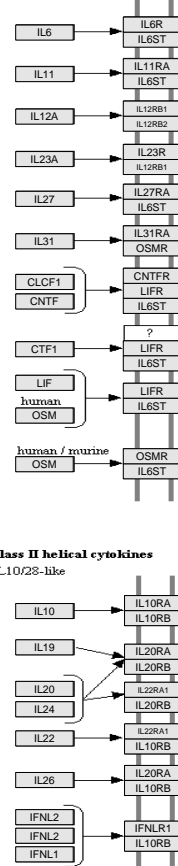

Interferon family

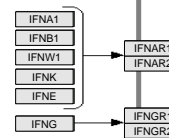

IL1-like cytokines

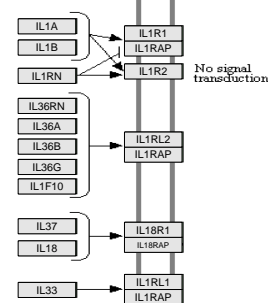

IL17-like cytokines

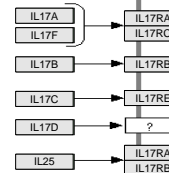

Non-classified

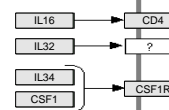

TNF Family

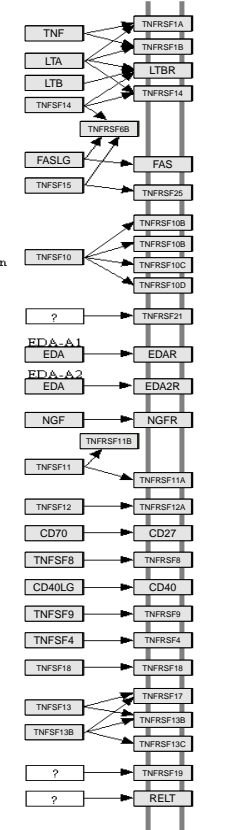

TGF-β family

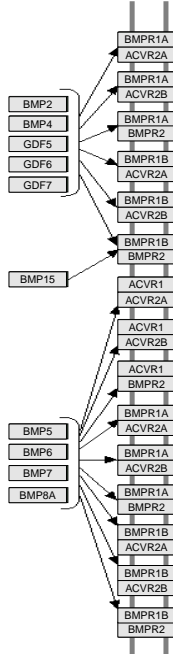
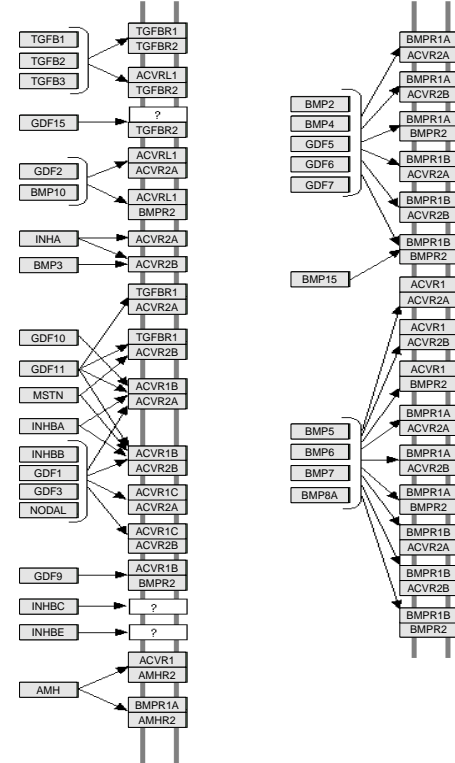

Cytokine_cytokine_receptor_interaction group 8

Chemokines

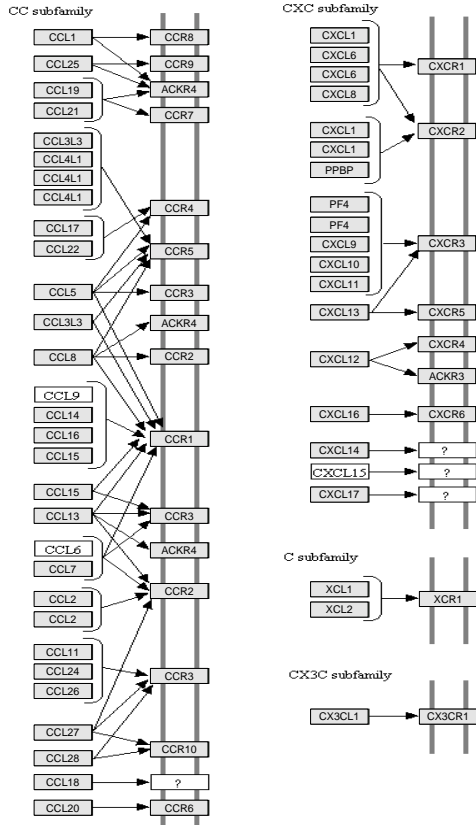

The class I helical cytokines
γ-chain utilizing

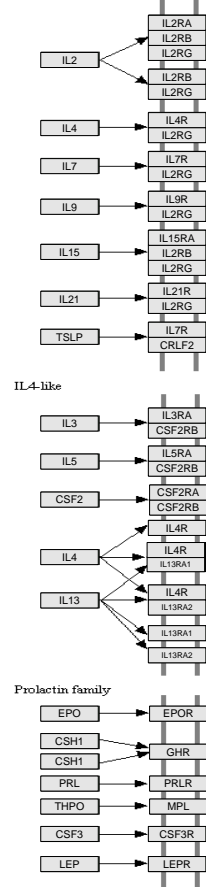

IL6/12-like

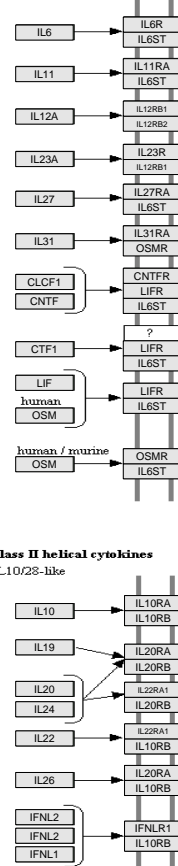

Interferon family

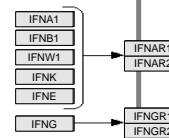

IL1-like cytokines

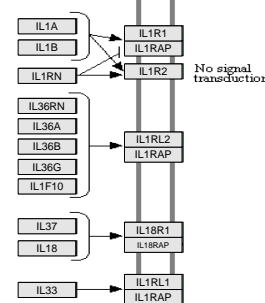

No signal transduction

IL17-like cytokines

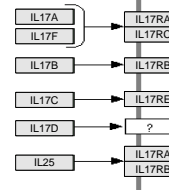

Non-classified

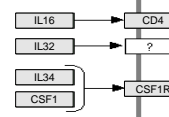

TNF Family

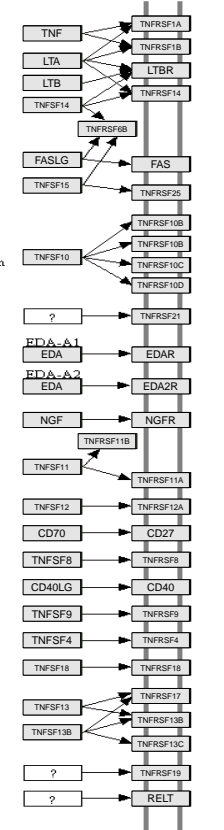

TGF-β family

