

Antigen processing and presentation

all genes

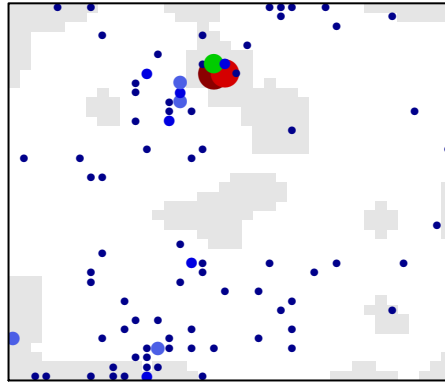

sink node genes

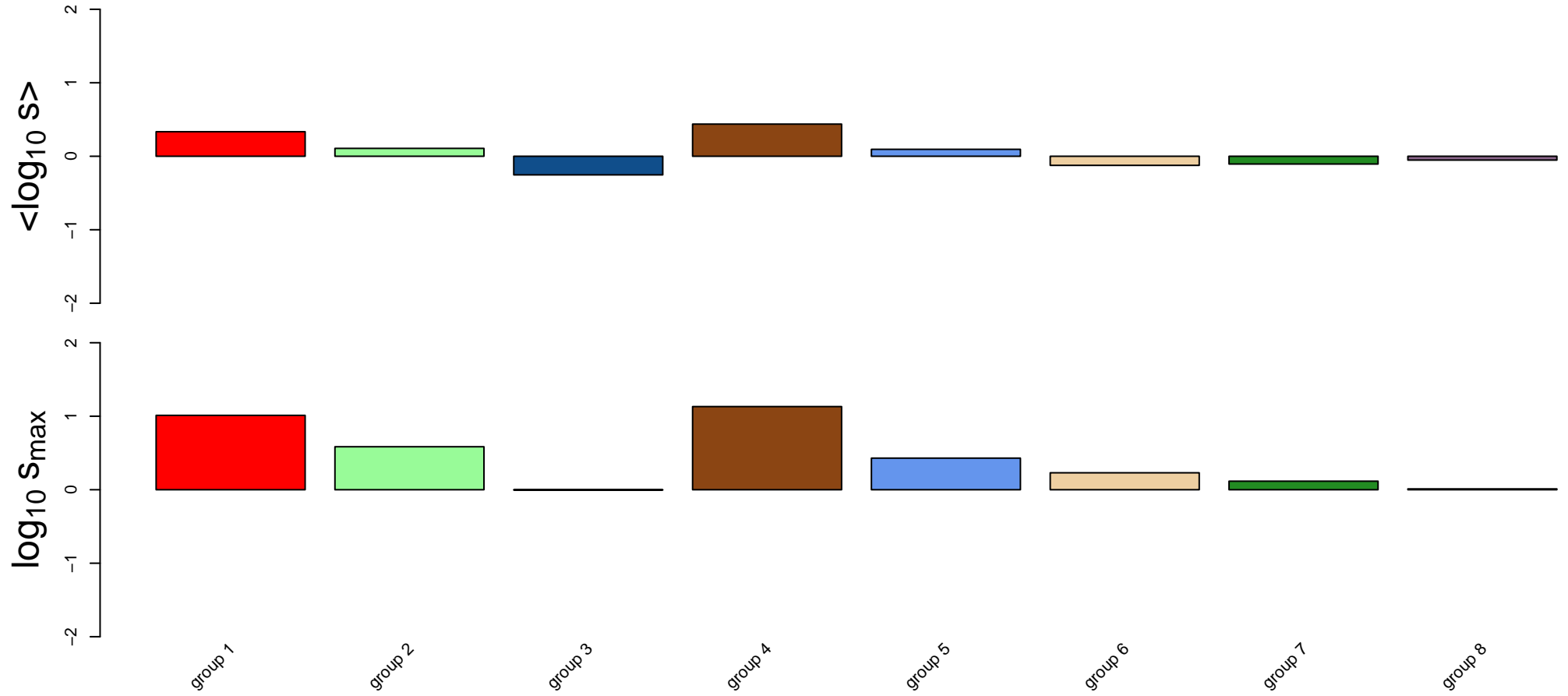
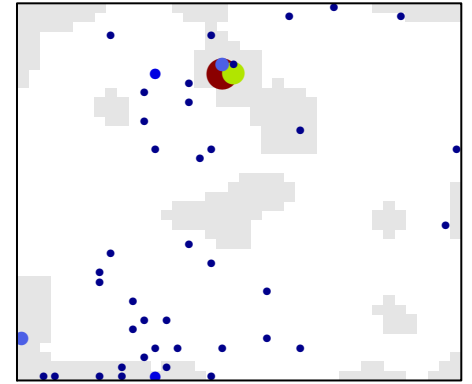

MHC I pathway

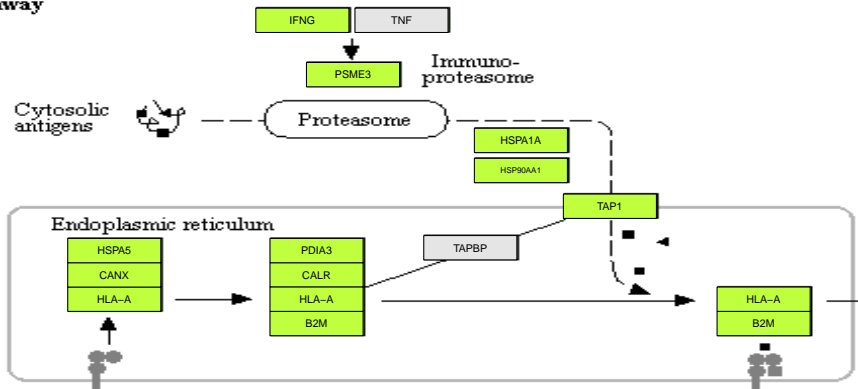

MHC II pathway

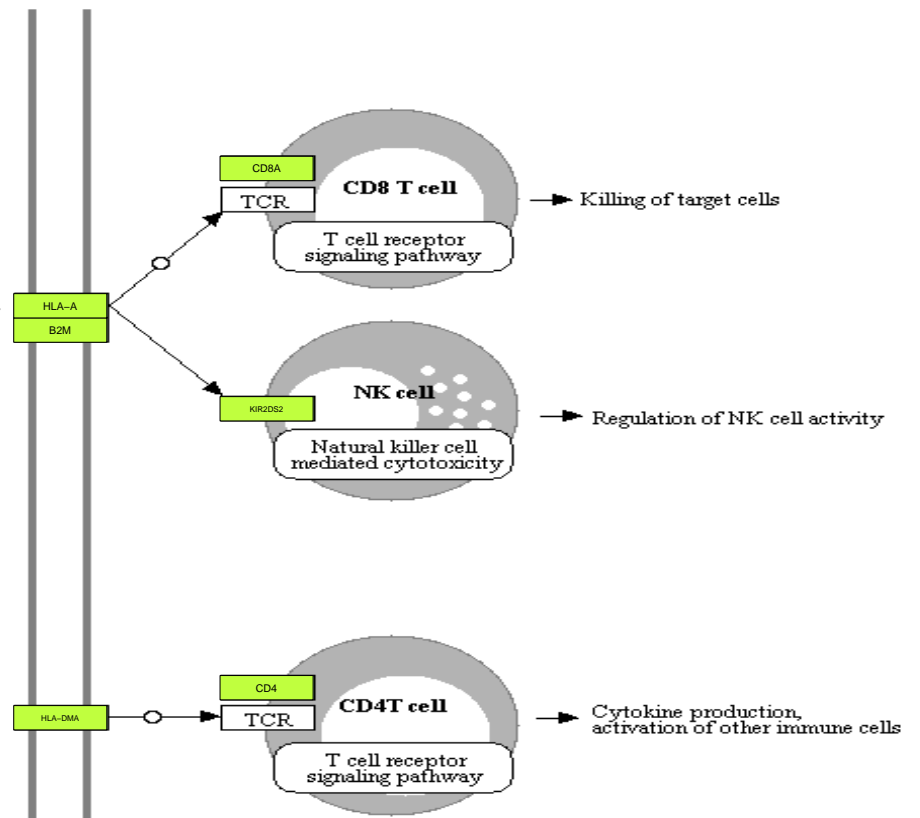
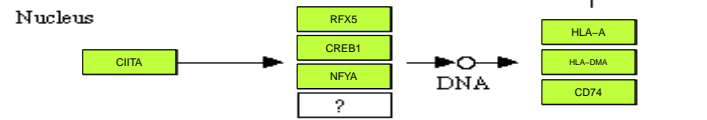
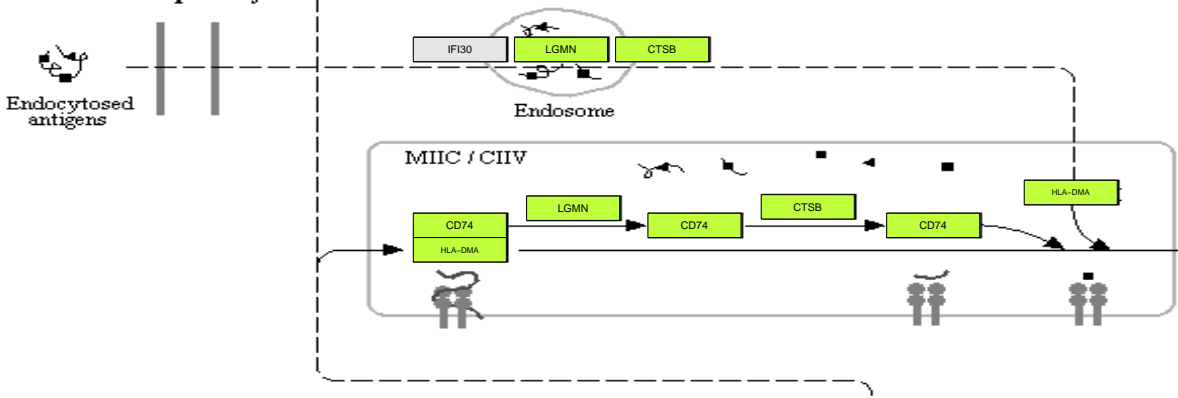

MHC I pathway

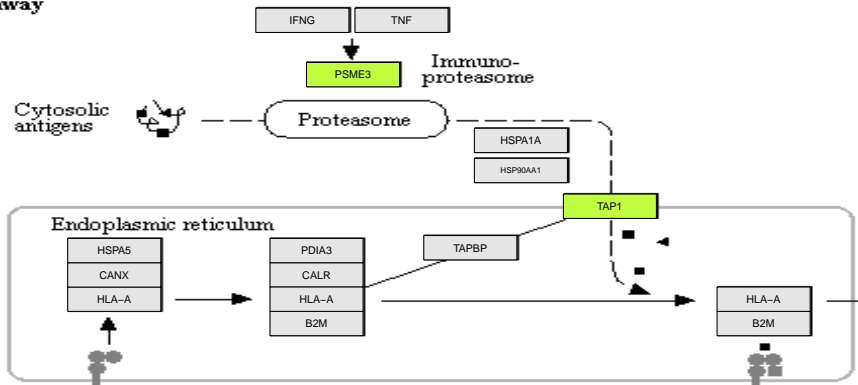

MHC II pathway

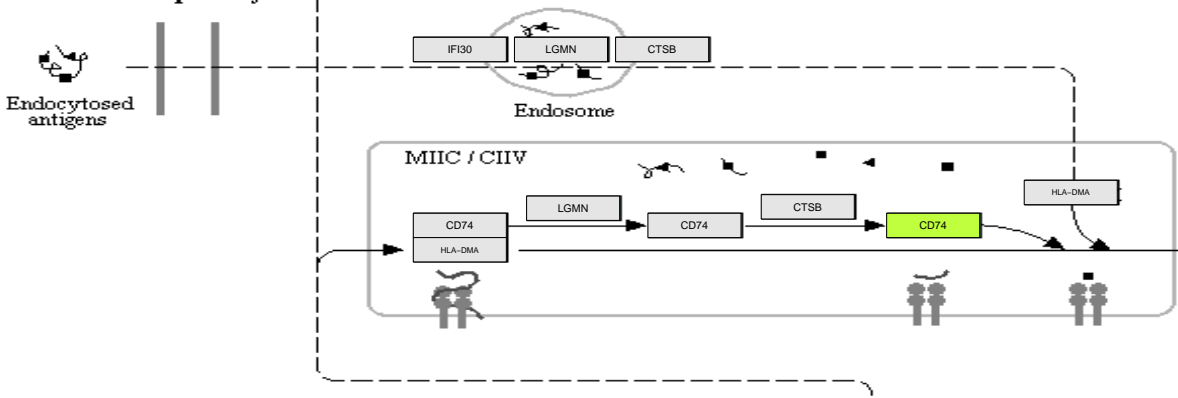

Nucleus

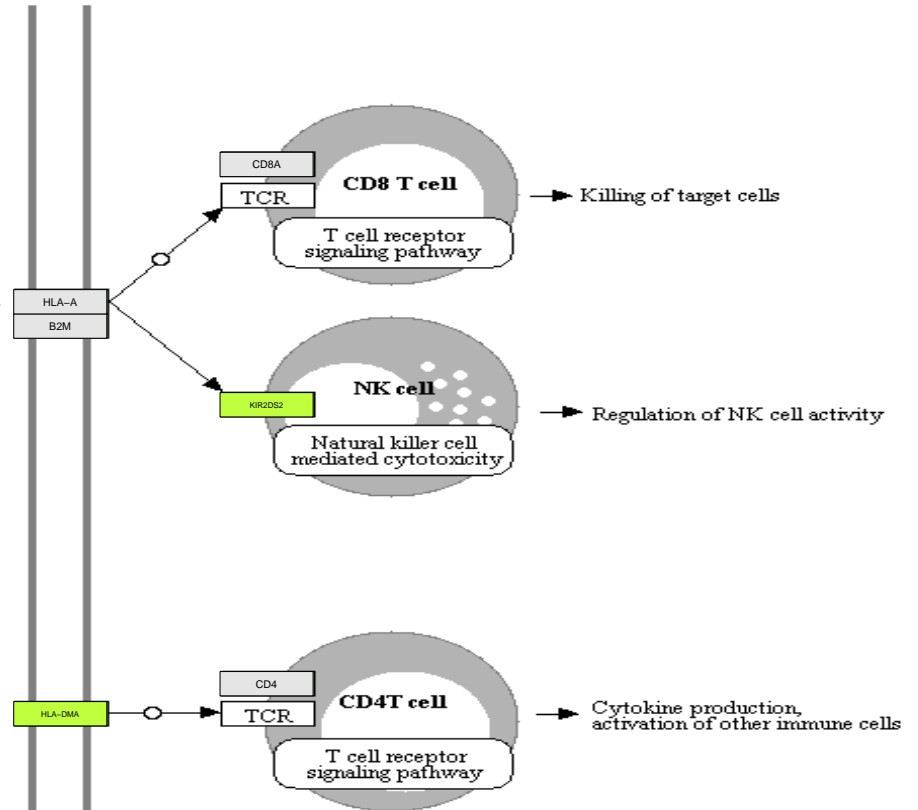
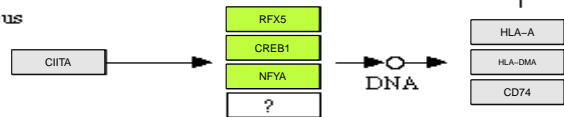

MHC I pathway

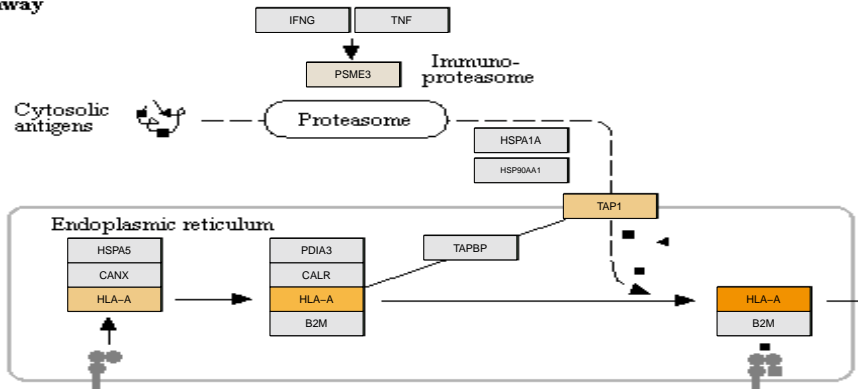

MHC II pathway

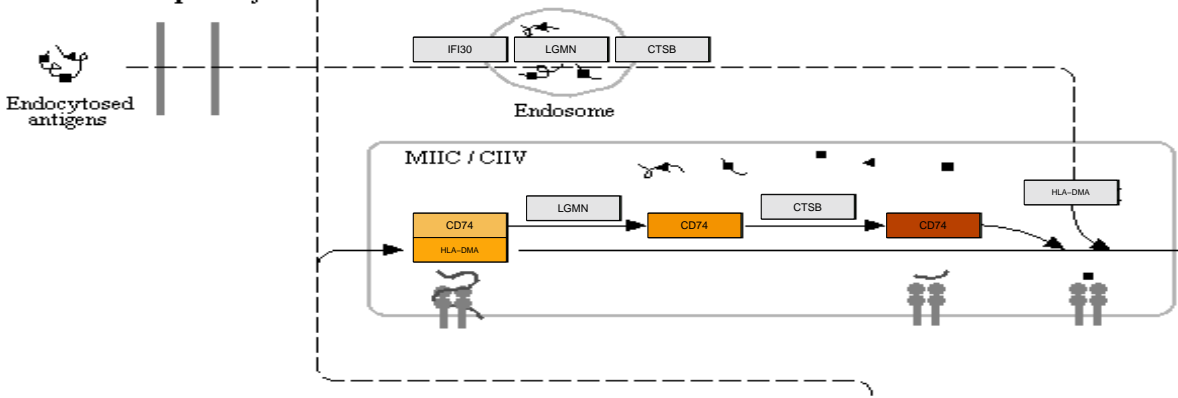

Nucleus

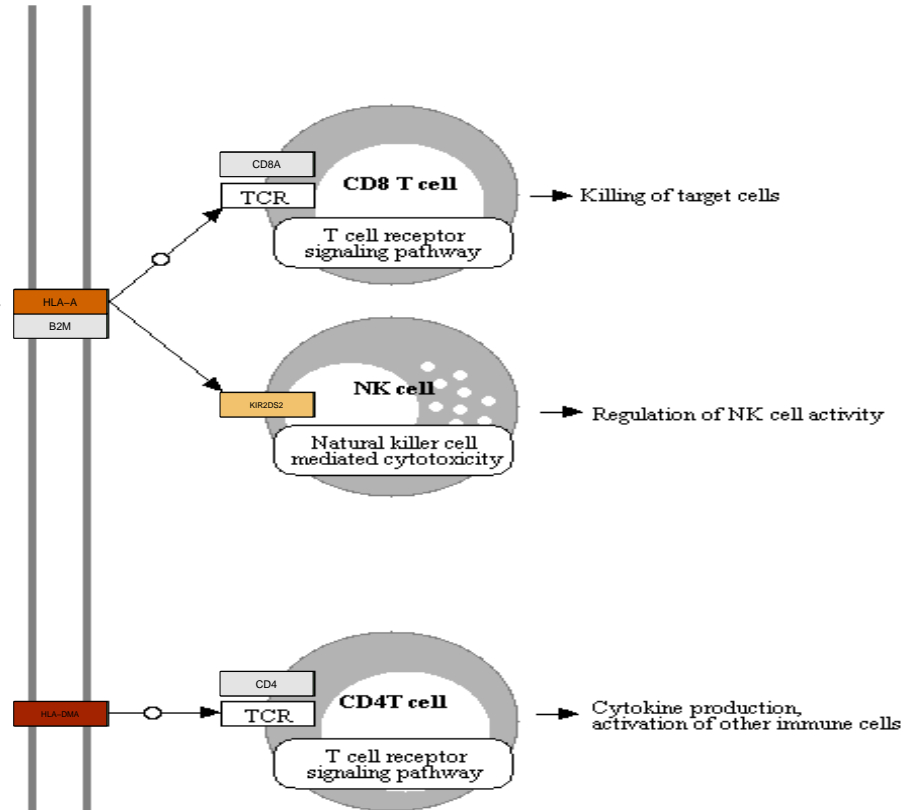
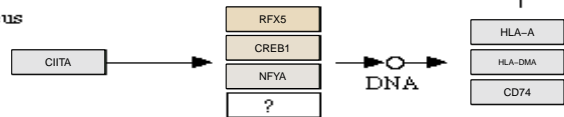

MHC I pathway

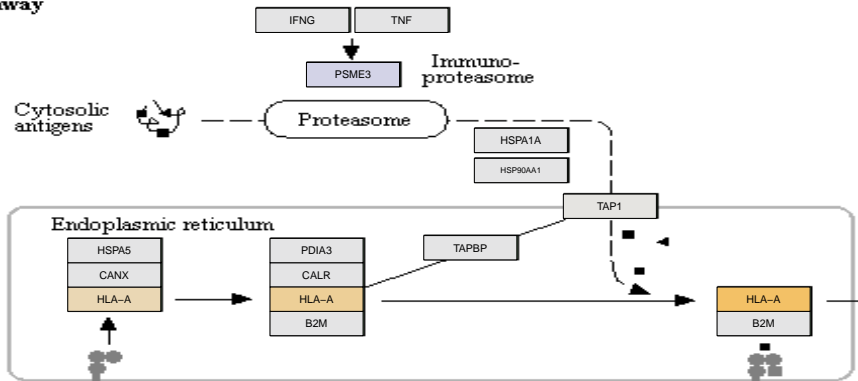

MHC II pathway

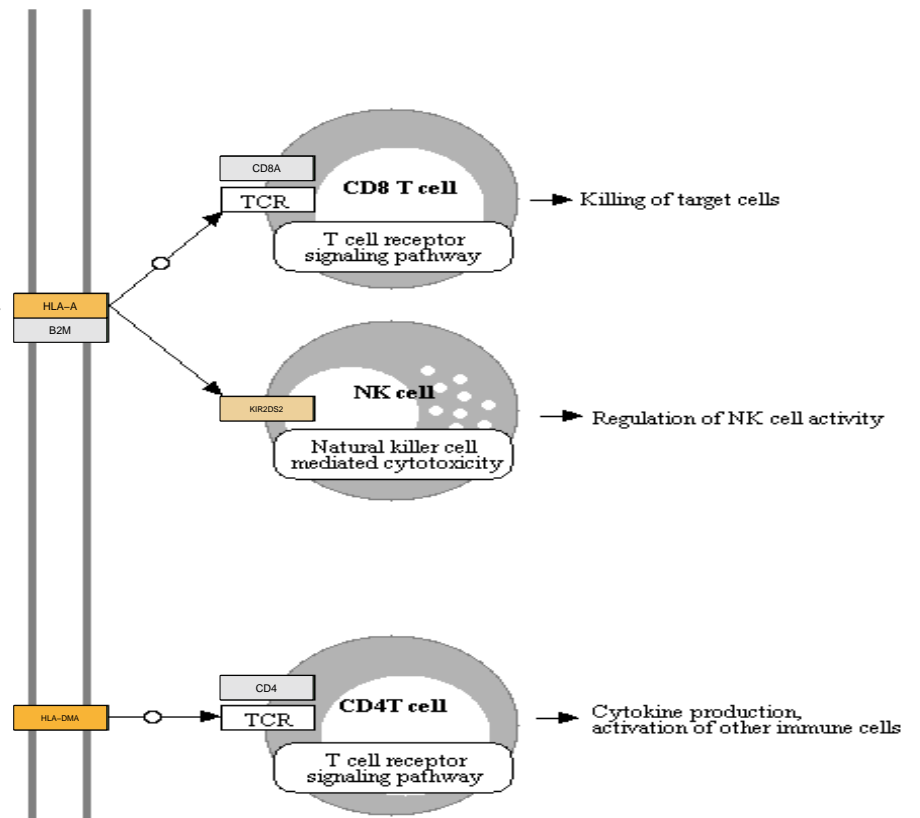
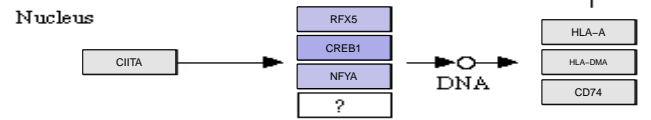
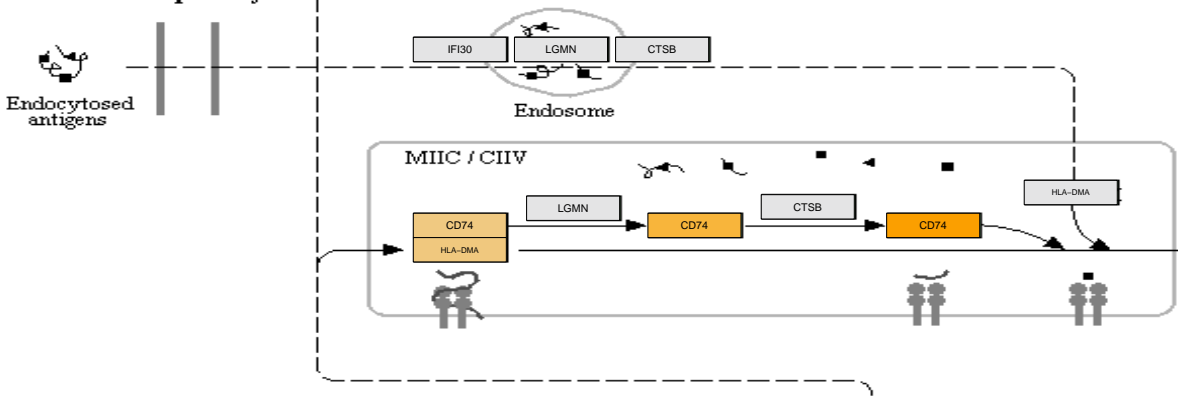

MHC I pathway

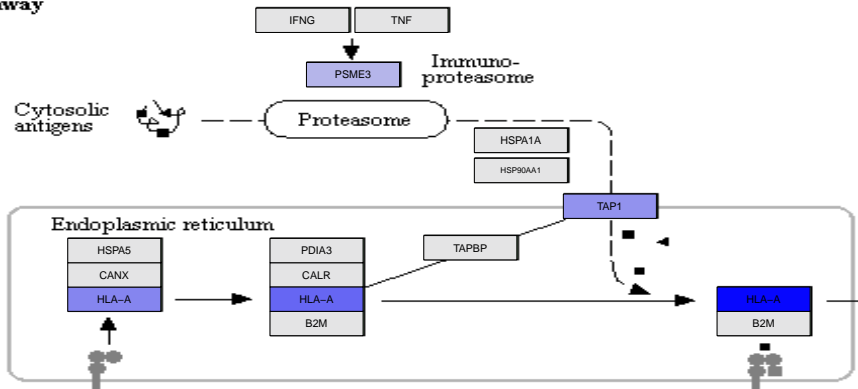

MHC II pathway

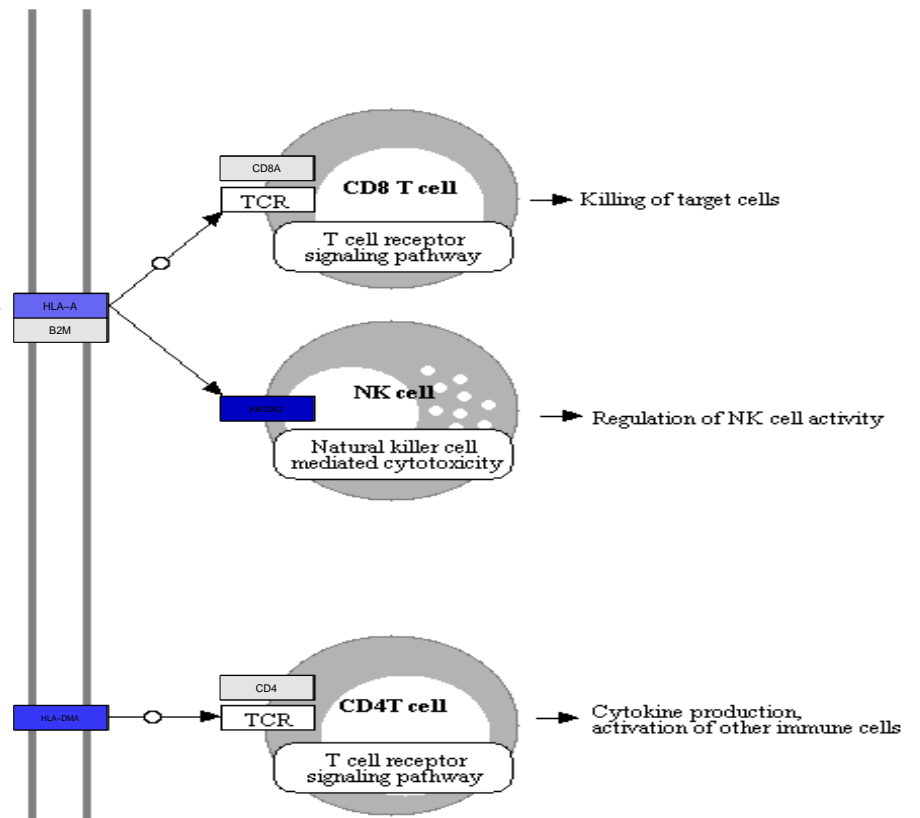
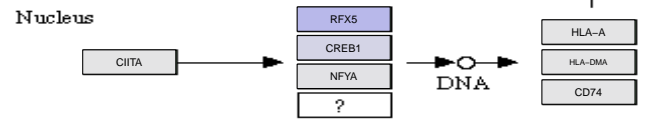
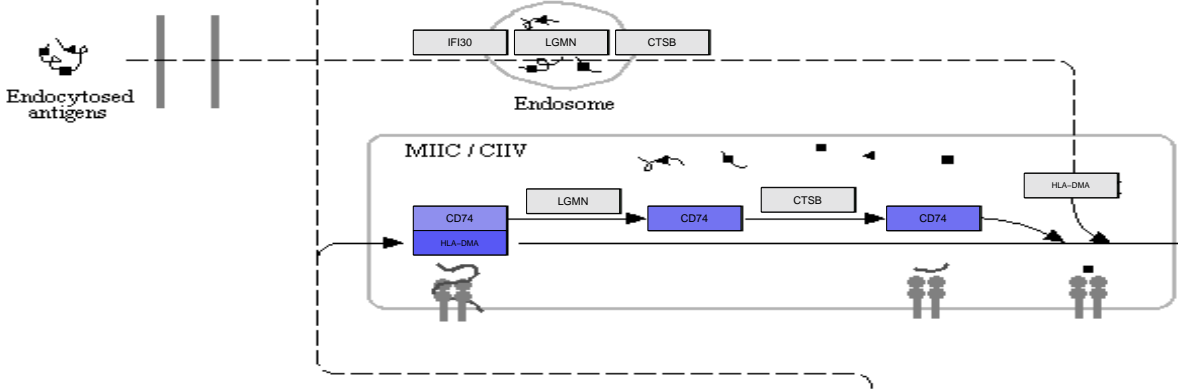

MHC I pathway

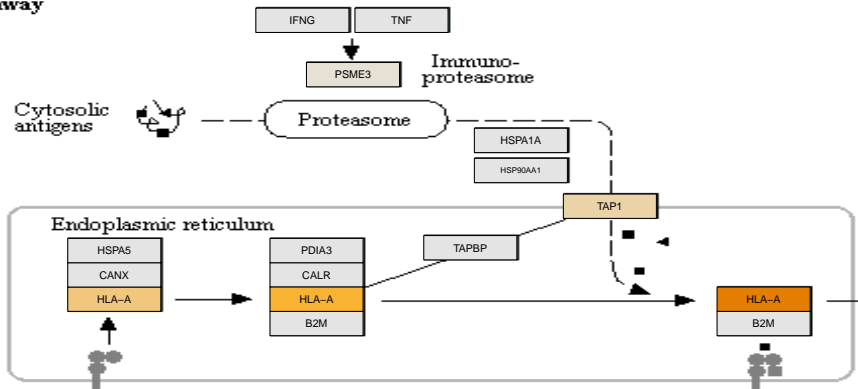

MHC II pathway

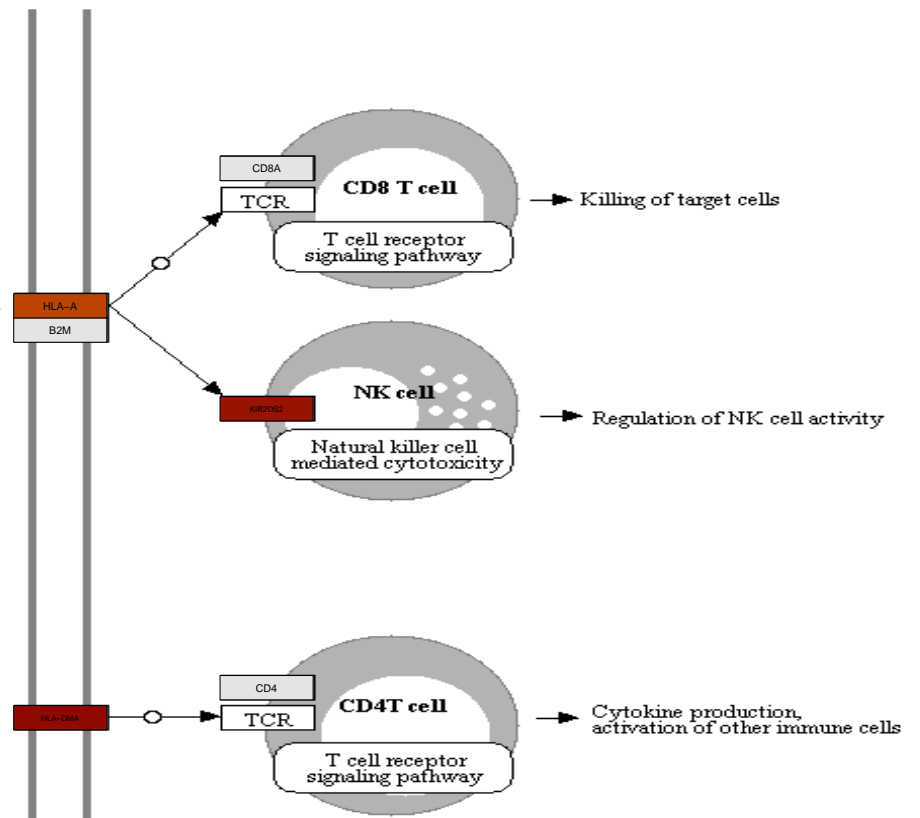
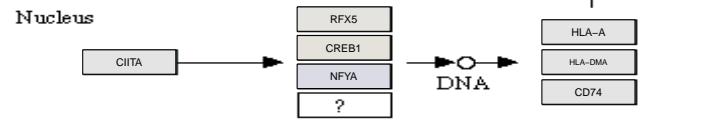
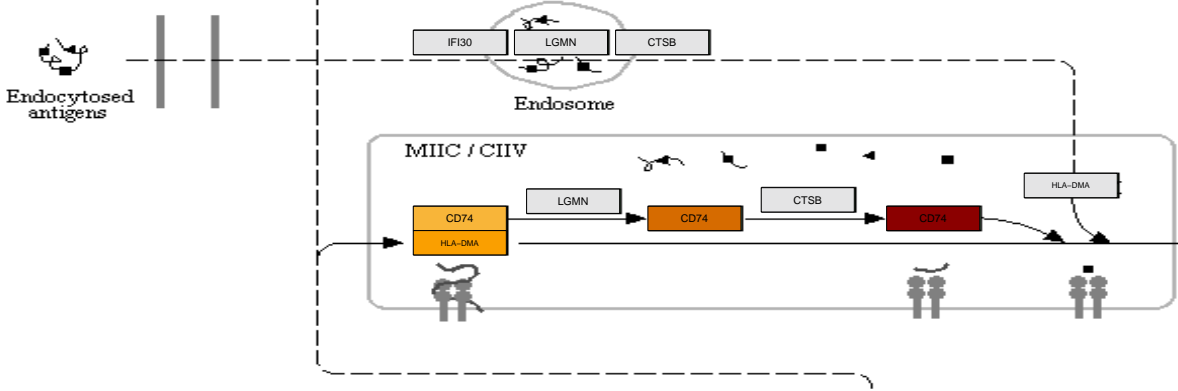

MHC I pathway

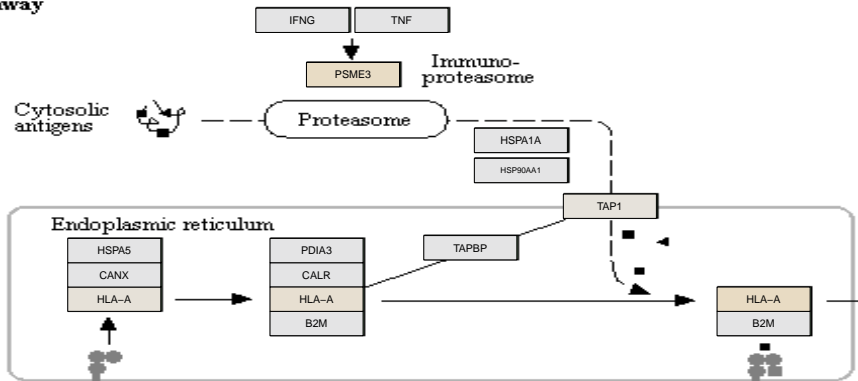

MHC II pathway

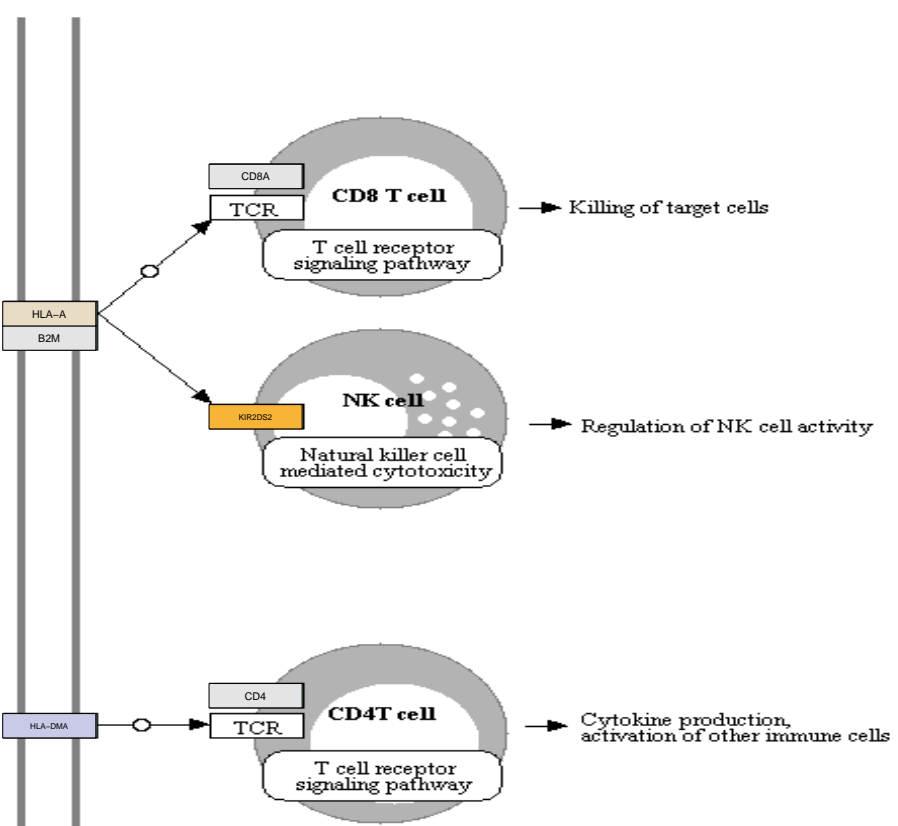
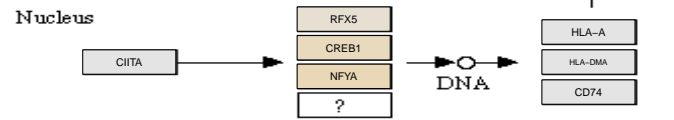
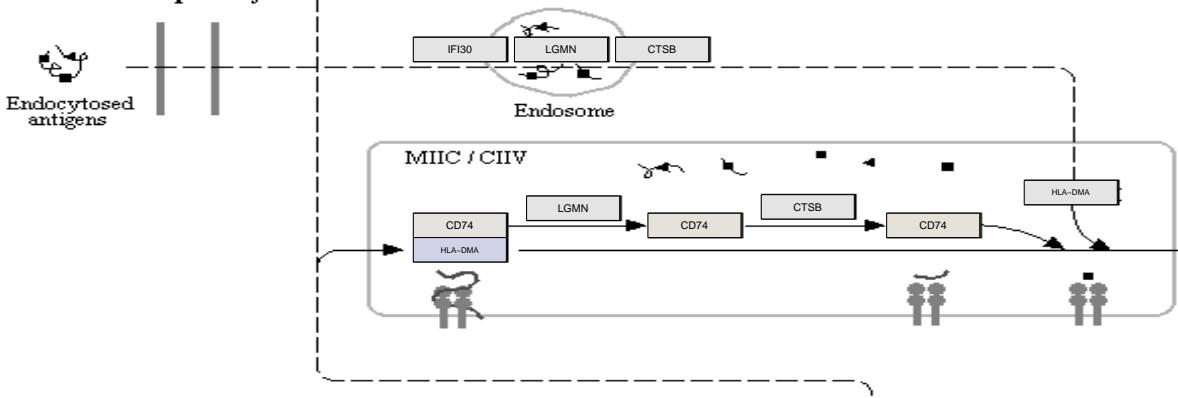

MHC I pathway

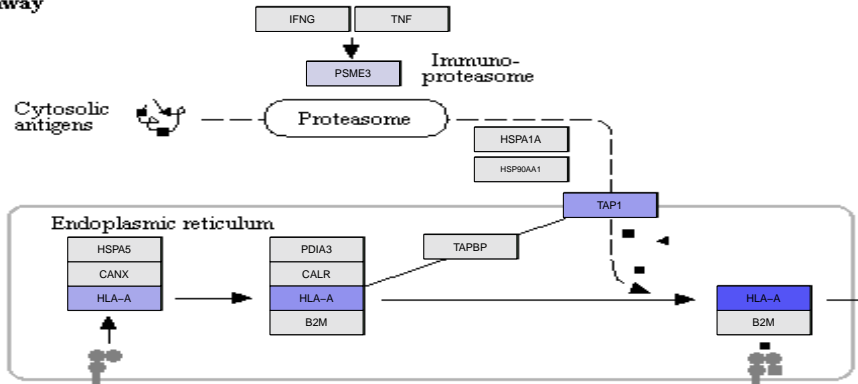

MHC II pathway

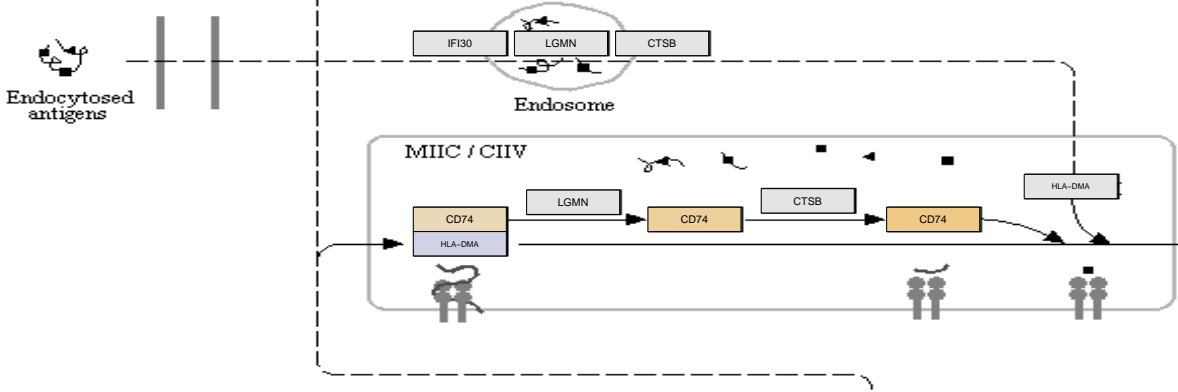

Nucleus

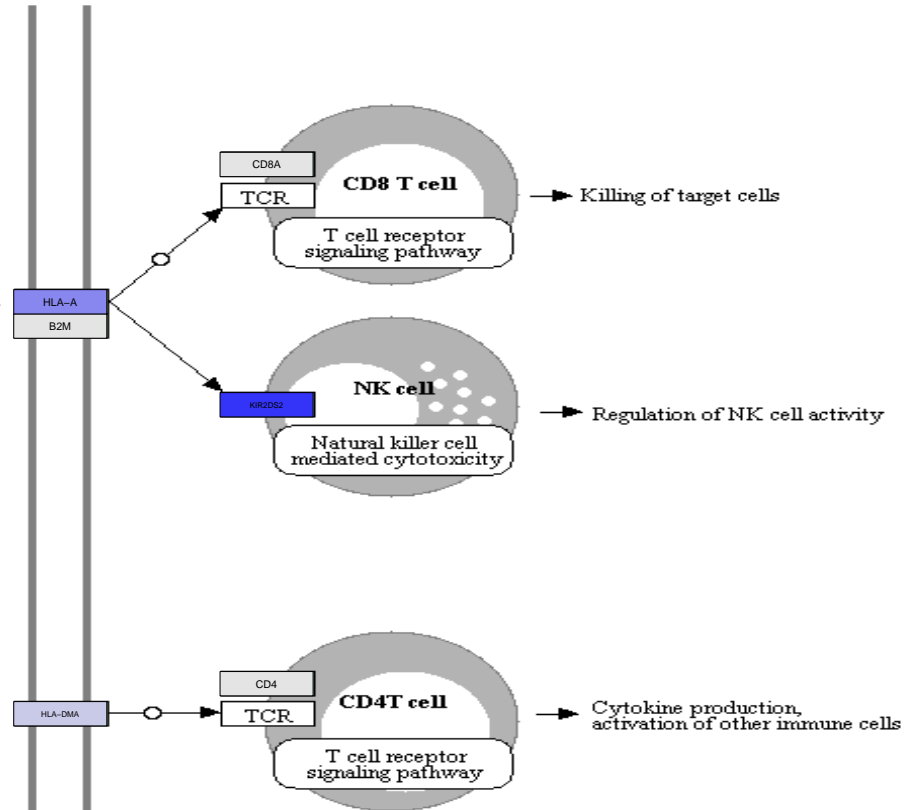
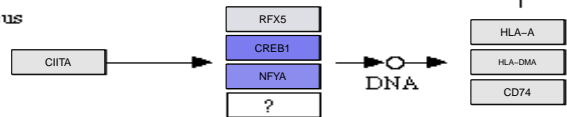

Antigen_processing_and_presentation
group 7

MHC I pathway

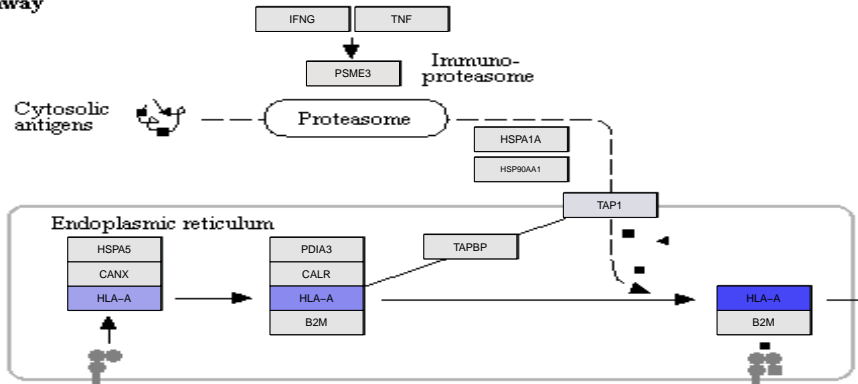

MHC II pathway

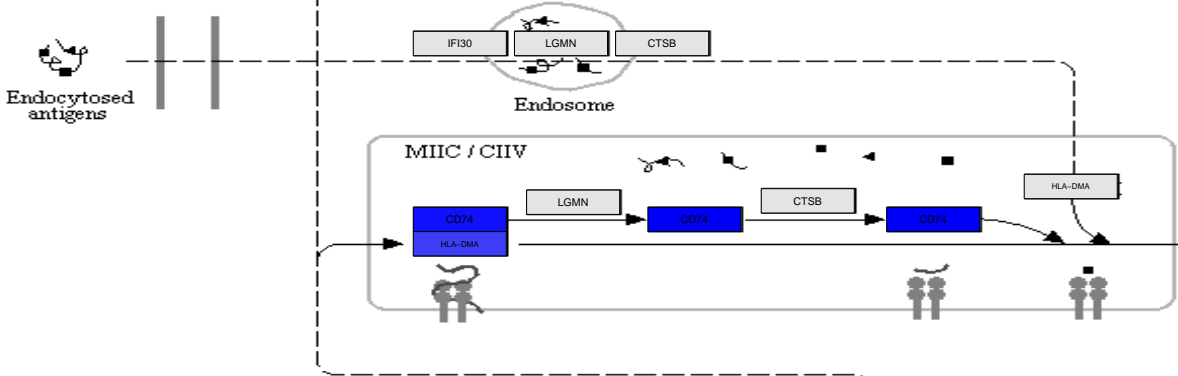

Nucleus

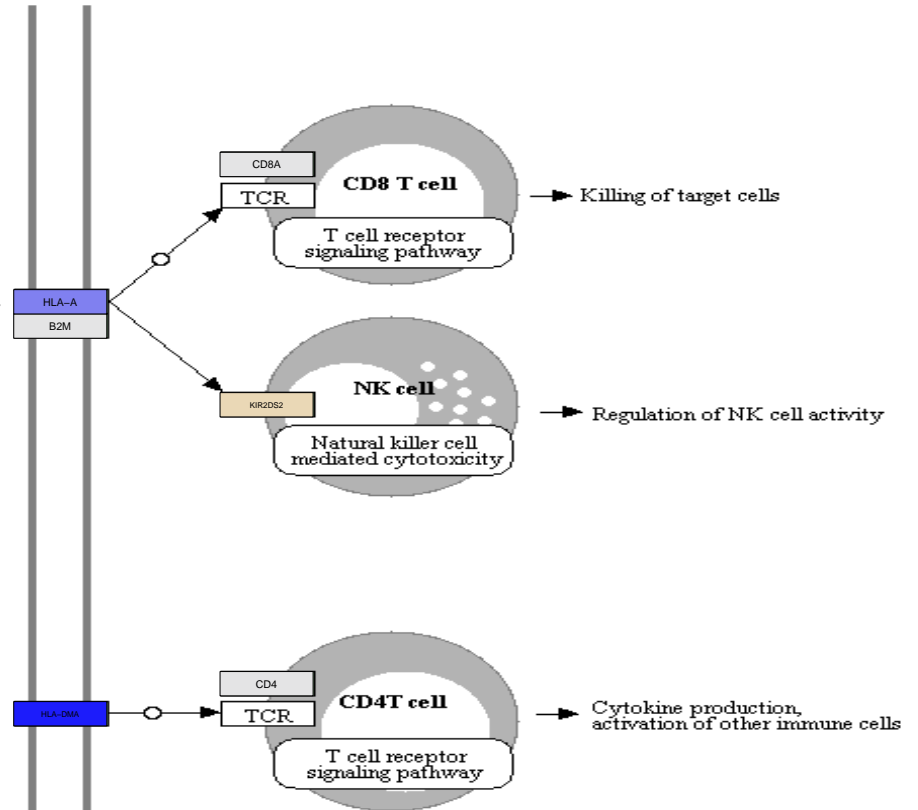
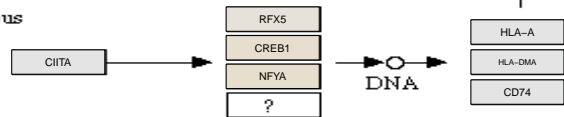

Antigen_processing_and_presentation
group 8

MHC I pathway

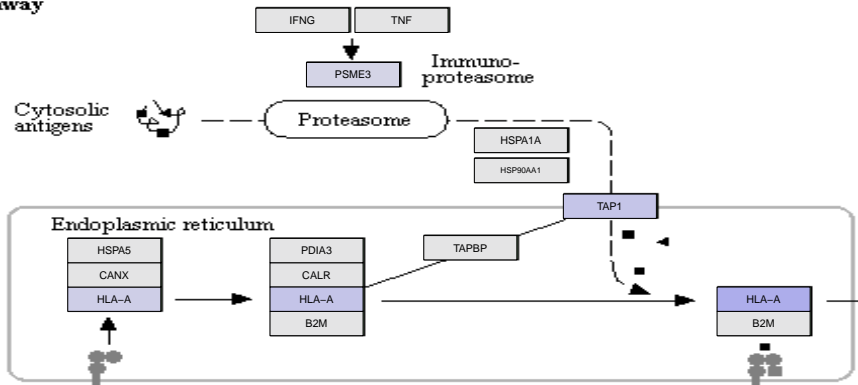

MHC II pathway

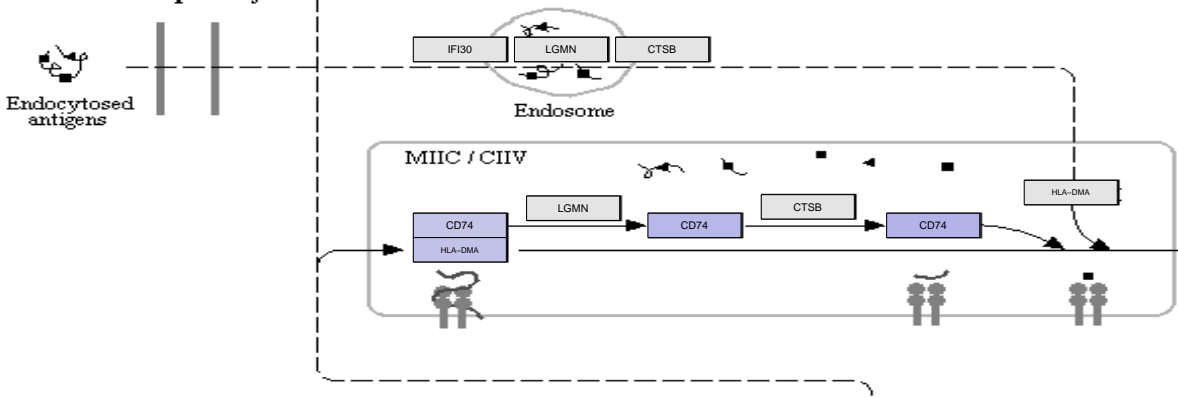

Nucleus

